

# Biomedical and Pharmaceutical Polymers

Denis Labarre, Gilles Ponchel  
and Christine Vauthier

**(PP)**  
**Ph**  
Pharmaceutical Press

**UJLA** pharmacy  
series

# **Biomedical and Pharmaceutical Polymers**

# ULLA Pharmacy Series

## **Editor in Chief**

Prof Anthony C Moffat

The School of Pharmacy, University of London, UK

## **Members of the Editorial Advisory Board**

Prof Patrick Augustijns, Katholieke Universiteit Leuven, Laboratory for Pharmacotechnology and Biopharmacy, Belgium

Prof Franco Bernini, University of Parma, Dipartimento di Scienze Farmacologiche, Biologiche e Chimiche Applicate, Italy

Prof Meindert Danhof, LACDR, Director of Research, the Netherlands

Prof Lennart Dencker, Uppsala University, Faculty of Pharmacy, Department of Pharmaceutical Biosciences, Sweden

Prof Elias Fattal, University Paris-South, Faculty of Pharmacy, France

Prof Sven Frokjaer, University of Copenhagen, Faculty of Pharmaceutical Sciences, Denmark

Prof Flemming Jorgensen, University of Copenhagen, Faculty of Pharmaceutical Sciences, Department of Medicinal Chemistry, Denmark

Prof Denis Labarre, University Paris-South, Faculty of Pharmacy, France

Prof Fred Nyberg, Uppsala University, Faculty of Pharmacy, Department of Pharmaceutical Biosciences, Sweden

Prof Patrizia Santi, University of Parma, Dipartimento Farmaceutico, Italy

Prof Nico Vermeulen, LACDR-Section of Molecular Toxicology, Department of Chemistry and Pharmacology, the Netherlands

## **Other titles in the ULLA pharmacy series include:**

*Pharmaceutical Toxicology*

*Paediatric Drug Handling*

*International Pharmacy Practice Research*

*Molecular Biopharmaceutics*

*Proteomics and Metabolomics in Pharmaceutical Science*

*Managing and Developing Learning in Healthcare*

NB: Some of the titles listed are forthcoming/not yet published.

# Biomedical and Pharmaceutical Polymers

by

**Denis J-P Labarre**

Professor of Polymer Chemistry

Faculty of Pharmacy

University Paris-South-XI

**Gilles Ponchel**

Professor of Pharmaceutical Technology and Biopharmacy

Faculty of Pharmacy

University of Paris-South-XI

**Christine Vauthier** PhD

Director of Research

CNRS (Centre National de la Recherche Scientifique)

France



**Published by Pharmaceutical Press**

1 Lambeth High Street, London SE1 7JN, UK  
1559 St. Paul Avenue, Gurnee, IL 60031, USA

© Pharmaceutical Press 2011

**(PP)** is a trade mark of Pharmaceutical Press

Pharmaceutical Press is the publishing division of the Royal Pharmaceutical Society of Great Britain

First published 2011

Typeset by Thomson Digital, Noida, India  
Printed in Great Britain by TJ International, Padstow, Cornwall

ISBN 978 0 85369 730 5

All rights reserved. No part of this publication may be reproduced, stored in a retrieval system, or transmitted in any form or by any means, without the prior written permission of the copyright holder.

The publisher makes no representation, express or implied, with regard to the accuracy of the information contained in this book and cannot accept any legal responsibility or liability for any errors or omissions that may be made.

The right of Denis Labarre, Gilles Ponchel and Christine Vauthier to be identified as the authors of this work has been asserted by them in accordance with the Copyright, Designs and Patents Act, 1988.

A catalogue record for this book is available from the British Library.



# Contents

Preface	vii
About the authors	ix
Abbreviations	xi
<b>1 Introduction: why study polymers for the health sciences?</b>	<b>1</b>
1.1 Polymers are large molecules that nature relies on	2
1.2 A brief history of polymers	4
1.3 Definitions	5
1.4 Morphology and nomenclature of polymers	6
Bibliography	16
<b>2 General characteristics of polymers</b>	<b>19</b>
2.1 Characterisation of polymers	20
2.2 Specific properties of polymers in the presence of liquid media	35
2.3 Relationships between structure of polymers and cohesion of materials	44
2.4 Properties of polymers as materials	48
Bibliography	53
<b>3 Main methods and processes to synthesise polymers</b>	<b>55</b>
3.1 Why there is a need to synthesise polymers	55
3.2 Introducing step and chain polymerisation	56
3.3 Some examples of step polymerisation: from small reagents and from prepolymers	58
3.4 Free radical chain polymerisation	59
3.5 Limitations of polymerisation	64
3.6 Overview of other synthetic methods	66
3.7 Polymerisation reaction processes	73
3.8 Copolymerisation	80
3.9 Modifications of polymers	81
Bibliography	85

<b>4</b>	<b>Special properties of polymers, case studies and detailed examples of applications</b>	<b>87</b>
4.1	Properties of block copolymers: phase separation in solution and at solid state	87
4.2	Biodegradable and bioerodible polymers	91
4.3	Applications of polymers in biomedical uses	98
4.4	Applications of polymers in pharmaceutical uses	114
	Bibliography	148
	<b>Glossary</b>	<b>151</b>
	<b>Index</b>	<b>155</b>

# Preface

Why a textbook on biomedical and pharmaceutical polymers?

A considerable number of books have already been published on polymers. Despite this, my experience as a teacher is that no simple textbook is available for introducing polymers to graduate and postgraduate students who use them in the biomedical and pharmaceutical fields. The subject of polymers is taught to students in materials science who are supposed to conceive new polymers and processes, or to be involved in the production, transformation and design of polymer-based items. An introduction to polymers is not frequently given to students in the domain of health, but polymers are increasingly present in this multidisciplinary domain. Such users of polymers are confronted with an overwhelming number of specialised books in which they just cannot find the information that they need in their specialised domain.

The aim of this book is to provide these students with an introduction to the general concepts of polymer science and some insights into speciality polymers used and developed for biomedical and pharmaceutical applications. The book is the result of the experience of the authors especially after courses given both at ULLA Doctoral Summer Schools and at the Faculty of Pharmacy of Châtenay-Malabry, University of Paris South-XI.

The book was designed in such a way that the user can find useful general information at the beginning, followed by a specialised part dedicated to synthesis, and finally some examples of biomedical and pharmaceutical applications.

Denis Labarre  
July 2010





# About the authors

**Denis J-P Labarre** is professor in polymer chemistry at the Faculty of Pharmacy of University Paris-South-XI, France. He started working in 1970 in the field of biomaterials. Having prepared covalently bound heparinised surfaces, he practised techniques of blood coagulation. He obtained a doctorate in sciences in 1977 on polymeric surfaces able to inhibit blood coagulation. In 1978, he joined the team of Professor EW Merrill at MIT to develop antithrombogenic polymeric surfaces, in collaboration with Professors RD Rosenberg and EW Salzman. As associate professor at the University of Paris-North, he did research in heparin-like polymer surfaces able to modulate blood coagulation and activation of the complement system. An expert in the interdisciplinary field of interactions between polymers and blood, he joined the team of Professor F Puisieux at the University of Paris-South-XI in 1992. He has worked on long-circulating polymeric nanoparticles for drug delivery and on polymeric systems used in therapeutic embolisation.

**Gilles Ponchel** has been full professor at the University of Paris-South-XI since 2000, where he teaches pharmaceutical technology and biopharmacy. He is leading a multidisciplinary research team specialising in the field of drug delivery, with the aim of developing innovative drug-delivery systems able to improve the crossing of physicochemical and biological barriers, which limit efficient delivery of active drugs to their pharmacological targets. His main research topics are (i) the development and the evaluation of bioadhesive delivery systems and (ii) the conception of pharmaceutically acceptable multifunctional nanoparticles prepared from various materials (e.g. tailored polymers, cyclodextrins) for optimising the interactions with living matter in the context of targeted applications. One of his specific interests is to gain a better understanding at the molecular level of the relationships between surface properties of nanoparticles and their capacities of interacting in the body, through various phenomena, including bioadhesion. He is the author of over 100 research papers, more than 100 communications, many invited lectures and a few patents. He is especially interested in promoting the pharmaceutical development of bioadhesive delivery systems through specific collaborative projects with pharmaceutical startup companies in the field.

**Christine Vauthier**, PhD, is Director of Research at the Centre National de la Recherche Scientifique (CNRS). Her research focuses on the design of biodegradable polymer nanoparticles for mucosal and intravenous administration of drugs. More specifically, she is interested in the influence of the biomaterial structure on the *in vivo* fate of nanoparticles for optimising the design strategy of nanoparticulate drug-delivery systems from the conception of the constituting polymer. She is author of more than 75 research papers and over 20 review papers and book chapters on nanoparticle preparation and characterisation methods and on the application of nanoparticles as drug-delivery systems. She has presented over 100 communications and many invited conferences. She serves as an editor for *Pharmaceutical Research*.

# Abbreviations

Abbreviated names of the most common polymers are given in Table 1.2.

ACA	alkylcyanoacrylate
AIBN	2,2'-azo bis isobutyronitrile
ATR-IR	attenuated total reflectance infrared spectroscopy
ATRP	atom transfer radical polymerisation
AVM	arteriovenous malformation
BPO	benzoyl peroxide
CMC	critical micelle concentration or, carboxymethyl cellulose
DEHP	di-(2-ethylhexyl) phthalate
DMA	dynamic mechanical analysis
DMSO	dimethylsulphoxide
DMT	dimethyltoluidine
DP <sub>n</sub>	number-average degree of polymerisation
DRI	differential refractive index
DSC	differential scanning calorimetry
EPR	enhanced permeation and retention
ESCA (or XPS)	electron spectroscopy for chemical analysis
G-CSF	granulocyte colony-stimulating factor
GIT	gastrointestinal tract
GM-CSF	granulocyte/macrophage colony-stimulating factor
HDPE	high-density polyethylene
HPC	hydroxypropylcellulose
HPMC	hydroxypropylmethylcellulose
INF- $\alpha$ 2b	interferon-alpha2b
IOL	intraocular lens
LDPE	low-density polyethylene
MALDI-TOF	matrix-assisted laser desorption/ionisation-time of flight
MC	methylcellulose
MFFT	minimum film-forming temperature
M <sub>n</sub>	number-average molecular weight
M <sub>v</sub>	viscosity-average molecular weight
M <sub>w</sub>	weight-average molecular weight

$M_z$	z-average molecular weight
MMA	methylmethacrylate
MPS	mononuclear phagocytic system
MRI	magnetic resonance imaging
MVTR	moisture vapour transmission rate
NCS	neocarzinostatin
NMR	nuclear magnetic resonance
NSFR	nitroxide-mediated stable free radicals
PACA	poly(alkylcyanoacrylate)
PEG	poly(ethylene glycol)
PEI	poly(ethyleneimine)
PEO	poly(ethylene oxide)
HEMA	poly(2-hydroxyethylmethacrylate)
PHPMA	poly(hydroxypropylmethacrylamide)
PI	polymolecularity or polydispersity index
PMN	polymorphonuclear neutrophil
PNIPAm	poly( <i>N</i> -isopropylacrylamide)
PSA	pressure-sensitive adhesive
RAFT	reversible addition fragment transfer
SEC	size-exclusion chromatography
SIMS	secondary-ion mass spectrometry
SMA	styrene-alt-maleic anhydride copolymer
SMANCS	conjugate between SMA and NCS
$T_c$	ceiling temperature
$T_g$	glass transition temperature
$T_m$	melting temperature
TEWL	transepithelial water loss
THF	tetrahydrofuran
WVTR	water vapour transmission rate

# 1

## Introduction: why study polymers for the health sciences?

---

1.1 Polymers are large molecules that nature relies on	2	1.4 Morphology and nomenclature of polymers	6
1.2 A brief history of polymers	4	Bibliography	16
1.3 Definitions	5		

---

Are polymers really exotic in the domain of health?

In the common sense, polymers are ‘plastics’, i.e. useful everyday materials produced in huge amounts and known among other things for polluting our environment, especially seashores. However, with the development of biomaterials in the 1980s, specialised polymers have become increasingly used in medicine as components of medical devices. Classical polymers have also been present for years in pharmacy as excipients for the oral route. More recently, with the development of nanobiotechnology, more sophisticated polymers have been developed, for instance as constituents of nanoparticulate systems for vaccine and drug delivery.

According to specific requirements, polymers have been used in devices for replacing deficient parts or assisting different functions of the body, thanks to the various physical and mechanical properties resulting from the bulk of the material, e.g. compliance. At this level, the user of polymers should also be aware of the fact that living tissues are in contact with polymers by their outermost surface. Thus, in addition to the classical properties for which polymers are used, the reactions and even the fate of the living tissues can be determined by the properties of the surface. To illustrate this, let us examine a simple *in vitro* experiment in which cells are grown in a polymeric vessel. Petri dishes are usually made of polystyrene, which is a transparent and

cheap polymeric material. However, cells cannot grow on such a hydrophobic surface. The surface of tissue-culture polystyrene Petri dishes is thus treated to increase hydrophilicity and to make normal cell growth possible, whereas the bulk is pure polystyrene (see Section 2.4.2).

As with other compounds in contact with living tissues, regulations concerning polymer use are strict, in particular with regard to purity. However, as polymers are not pure crystalline low-molecular-weight compounds, a ‘pure’ polymer cannot be defined in similar terms. Moreover, further tests of characterisation, for instance concerning surface properties, are usually needed.

Thus, polymers are less and less exotic in the domain of health, and learning some basic concepts about polymers is necessary in order to design better-adapted devices and excipients and to understand what may happen when polymers are in contact with living tissues. In addition, the knowledge of some special features linked to the use of such specialised polymers is required for those using them in the domain of health.

## 1.1 Polymers are large molecules that nature relies on

Life on Earth is linked to the presence of water, and water is our main constituent. However, all kinds of living species are not simply ‘bags of water’ but are highly organised. This specialised organisation depends on, among other compounds, macromolecules (Box 1.1), i.e. polymers that are able to retain and structure water, as natural **hydrogels**.

Many polymers have a natural origin (mineral, vegetal or animal). Some of these have been used for centuries. In the vegetal kingdom, cellulose is the most abundant macromolecule. Cellulose is a **polysaccharide** composed of repeating units of cellobiose, i.e. it is a dimer of glucose.

In the animal kingdom, chitin, a polymer of *N*-acetylglucosamine, is widely distributed as the main constituent of the shell of arthropods. Proteins and nucleic acids are well known as supports of life, and these natural polymers retain and structure water.

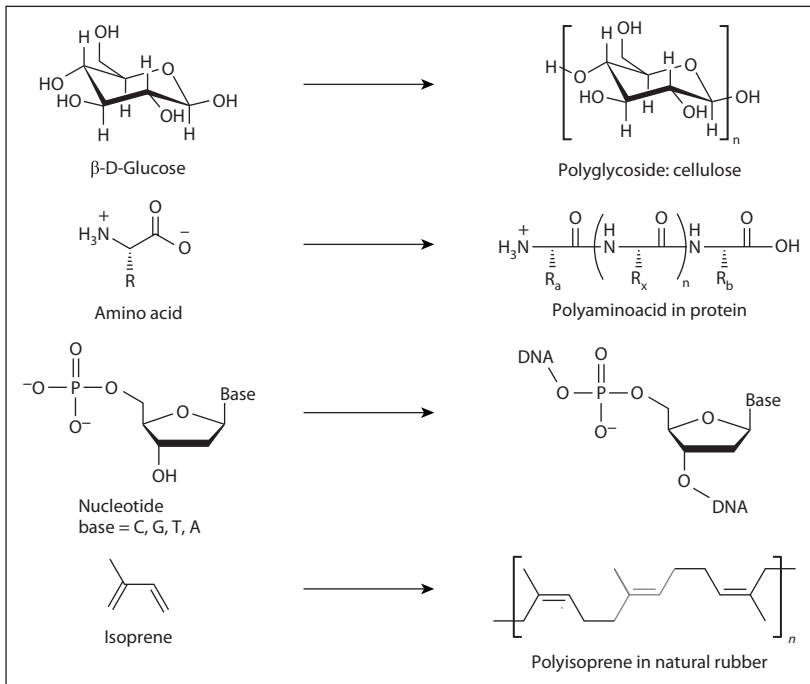
### Box 1.1

**Macromolecule** is a general name for a very large molecule. A high **polymer** is a macromolecule. A polymer produced by chemical synthesis is usually made from a limited number of repeating units, or **monomer** units. **Polypeptides** produced by chemical synthesis are made from amino acids. **Proteins** that are produced by biosynthesis contain mainly amino acids and may contain a few saccharidic or lipidic units.

For the sake of simplicity, the authors use the terms macromolecule and polymer interchangeably.

Macromolecules of vegetal or animal origin, i.e. **biopolymers**, are made through biosynthesis. Biosynthesis of proteins is strictly controlled by template-dependent processes, resulting in unique composition, molecular weight and structure for each protein in a given species. However, variants have been described. Such a strict control of characteristics is not always involved in the biosynthesis of many other natural polymers, as it is template-independent and chance plays a role. However, configuration is strictly controlled in biosynthesis of natural **polyolefins**, e.g. natural rubber, which is extracted from latex of *Hevea brasiliensis* and is composed of 97–98% of 1–4 *cis* units. Some natural polymers are shown in Figure 1.1.

All polysaccharides are natural polymers that constitute a good example of diversity in structure, molecular weight and composition. The structure of cellulose is very regular, conferring a high crystallinity to the polymer. Dextrans, other polymers of glucose, are produced by several strains of microorganisms. The molecular weight of dextrans varies from a few thousand grams per mole to about 1 million g/mol. The structure of dextrans varies from mainly linear to highly branched. The glycosaminoglycans family constitutes another example of **polymolecularity** and diversity of composition, resulting in a large spectrum of biological activities (Box 1.2).



**Figure 1.1** Some natural polymers.



**Box 1.2**

The glycosaminoglycans family is composed of hyaluronic acid, chondroitin sulphates, dermatan sulphate, heparan sulphate, heparin and keratan sulphate. They are present in diverse tissues, mainly as branches of very large proteoglycans, in which the core is constituted by proteins. Glycosaminoglycans are water-soluble or highly swollen. In this family, heparin itself constitutes a subfamily, as its composition and the resulting activities are diverse. For this reason, it may be more properly designated as ‘heparins’.

**1.2 A brief history of polymers**

Natural rubber can be considered as a ‘prehistoric polymer’, since it was used around 1600 BC to make balls by Manati Indians in the country that is now Mexico. Further, natural rubber was used for waterproofing boots and clothes. Natural rubber is runny and sticky when the temperature is hot, but it becomes stiff and brittle when the temperature is cold enough. In 1839, Goodyear found a way to improve rubber resistance to a larger range of temperatures by a process in which sulphur was used – **vulcanisation**. This finding led to the development of the rubber industry, especially for tyres.

Cellulose was modified more recently. Gun cotton was prepared as early as 1833 by Braconnot through high nitration of cellulose, and developed on a large scale in different countries. Less nitrated cellulosic derivatives were prepared as fibres (the first artificial silk), as photographic films and for many other items (e.g. dolls) thanks to the resistance and the high quality of appearance of this new material, celluloid. However, the flammability of celluloid was so high that it needed to be replaced by less dangerous materials such as regenerated cellulose (i.e. viscose) and cellulose acetates.

Some synthetic polymers, such as poly(vinyl chloride), were discovered at the end of the nineteenth century. In the early 1900s, Baekeland developed Bakelite, a rigid lightweight material obtained by reacting phenol and formaldehyde.

The macromolecular nature of such compounds was questioned for many years and they were simply classified as ‘colloids’. Biologists had isolated very long molecules from the living world, and it was difficult to even imagine the existence of synthetic macromolecules. Researchers had to deal with compounds with special properties compared with small molecules. It was not possible to crystallise or to evaporate them, and even their solubilisation was unusual. The available techniques were also unable to evidence the presence of covalent linkages in the molecules and to discriminate them from strong non-covalent interactions between molecules.

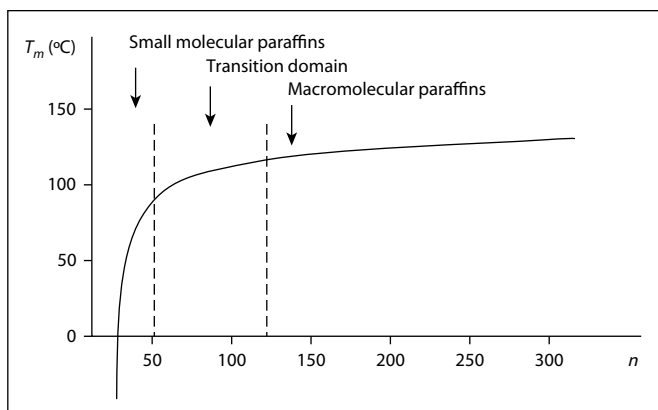
The macromolecular concept was proposed in 1917 by Staudinger, who received the Nobel Prize for chemistry in 1953. His theory was supported by the work of other researchers. Mark described the relationship between the viscosity of a polymer solution and its molecular weight (i.e. the Mark–Houwink–Sakurada relationship), demonstrating that cellulose was made of giant molecules. Carothers demonstrated the existence of synthetic macromolecules, and his researches led to the invention of the famous Nylon 6-6.

### 1.3 Definitions

A **polymer** is a macromolecule composed of either many repeating units of one type (i.e. **homopolymers**) or many repeating units of several types (i.e. **copolymers**). Synthetic polymers are usually obtained by linking together a large number of small molecules, termed **monomers**, which are generally at the origin of the repeating units, sometimes called **monomer units**. **Polymerisation** is the name of the reaction by which monomers combine together.

The molecular weight of polymers is usually an average, as polymolecularity is more often the case. The domain of molecular weight of polymers has no precise limits. In fact, the domain of polymers starts when most physical properties become independent of molecular weight, and it has no upper limit. This can be exemplified by the increase of melting temperature of linear paraffins, which tends towards a limit with the number of methylene units in the chain, as illustrated in Figure 1.2.

Many chemical modifications have been applied to natural polymers to create new materials and applications. A very large number of compounds made of modified cellulose or other modified natural polymers is currently in



**Figure 1.2** Defining the domain of polymers: melting temperature ( $T_m$ ) of normal paraffins as a function of the number ( $n$ ) of  $\text{CH}_2$  groups in the chain; after a sharp increase with  $n$ ,  $T_m$  tends to a plateau level when  $n$  is high enough.

use, including in the biomedical and pharmaceutical fields. An even wider diversity of properties and uses has been obtained with the development of synthetic polymers, which can be prepared by different methods and processes of polymerisation of one or more monomers. In the domain of health, a very interesting property of purely synthetic polymers is their absence of immunogenicity, unlike many polymers of natural origin.

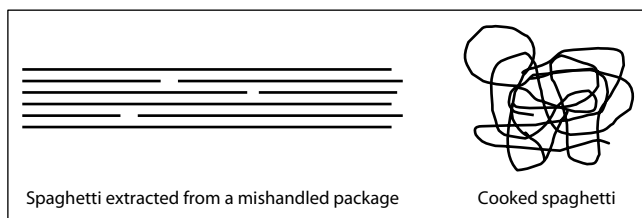
## 1.4 Morphology and nomenclature of polymers

A very large number of morphologies can be found in the world of polymers. The simplest polymers are composed of only one chain, sometimes called a backbone. These are named **linear polymers**, even if the shape is not really linear but is imposed by the angles of the successive chemical bonds. Linear polymers look like cooked spaghetti; the entangled chains are very difficult to separate from each other. The prolonged time that is usually necessary to dissolve polymers, and also many properties of polymers as solid materials, are explained by the entanglement of chains, as illustrated in Figure 1.3.

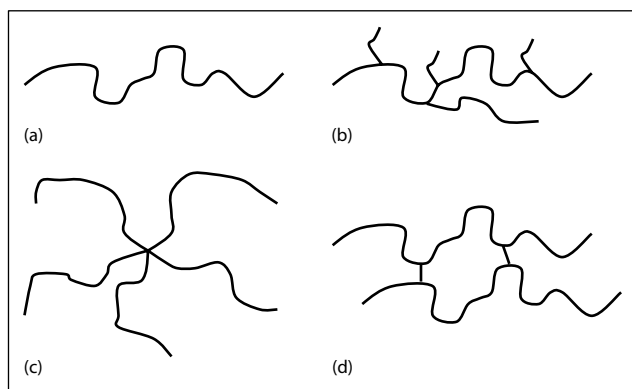
The morphology of polymeric chains is often more complicated than the morphology of linear chains. Polymers can be branched, comb-like, star-like, ladder-like, macrocyclic, dendritic or cross-linked, when chains are linked together, as illustrated in Figures 1.4 and 1.5.

### 1.4.1 Nomenclature of organic linear polymers

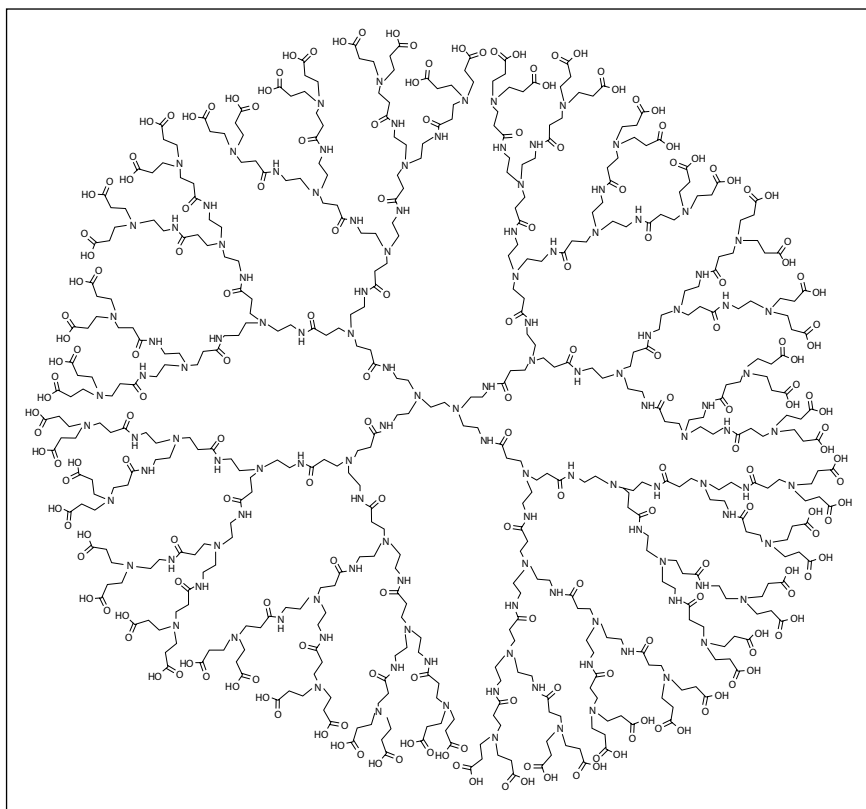
There are at least three nomenclatures for linear polymers. The official nomenclature has been defined by the International Union of Pure and Applied Chemistry (IUPAC) and is based on the simplest repeating unit present in the polymers. However, for several reasons the IUPAC nomenclature is not the most commonly used. The most common nomenclature, which is presented in this chapter, is based on the name of the repeating unit resulting



**Figure 1.3** Linear polymers can be compared to cooked spaghetti. Polymolecularity: size of polymer chains is a statistical data. Entanglement: polymeric chains are entangled and difficult to separate. A cohesive mass is formed at solid state and dissolving a polymer is generally time-consuming.



**Figure 1.4** Polymer backbone morphology is varied: linear (a), branched (b), star-like (c), cross-linked (d).



**Figure 1.5** Example of dendrimeric polymer.

from the monomer, which can be real or hypothetical (see poly(vinyl alcohol)). For this reason, the repeating unit is sometimes termed the ‘monomer unit’. Commercially available polymers also have a registered name, which is sometimes used as a generic name, e.g. ‘nylons’ for aliphatic polyamides.

Polymers are grouped in families defined by the chemical functions present in the main chain. Some usual families are presented in Table 1.1 and illustrated in Figures 1.6 and 1.7.

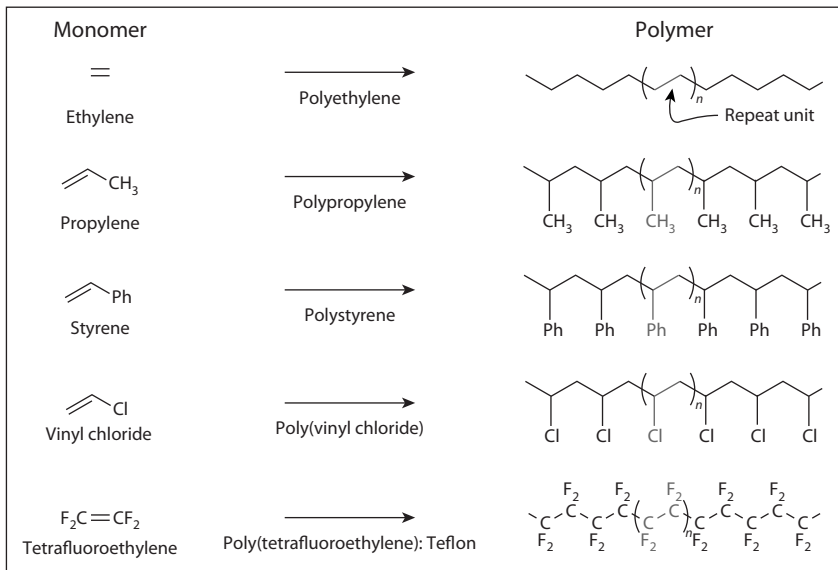
The main chain and side groups of polyolefins are completely composed of carbon and hydrogen. In the other families, the atoms constituting the chains can be different from carbon, and heteroatoms can be found as constituents of the backbone or side groups. The main chain of polyvinyls, polyvinylidenes and polyacrylics is composed of carbon. Each vinyl (i.e. ethenyl) unit bears one heteroatom, e.g. chlorine in poly(vinyl chloride). Each vinylidene unit bears two heteroatoms on the same carbon, and each acrylic unit bears one carboxyl-based group. The main chain of polyethers, polyesters, polyamides, polycarbonates, polyurethanes and polyureas is composed of repeating units that contain, respectively, ether, ester, amide, carbonate, urethane and urea. The main chain of a poly(ether urethanurea) contains ether, urethane and urea linkages. The main chain of polysiloxanes (i.e. silicones) is composed of oxygen- and silicon-bearing hydrocarbon groups.

The precise name of a polymer is given by poly(repeating monomer unit). Examples of usual polymers are given in Table 1.2.

Some singularities can be noticed. Poly(vinyl alcohol) is prepared not from vinyl alcohol, which is not stable, but by hydrolysis of poly(vinyl acetate). The

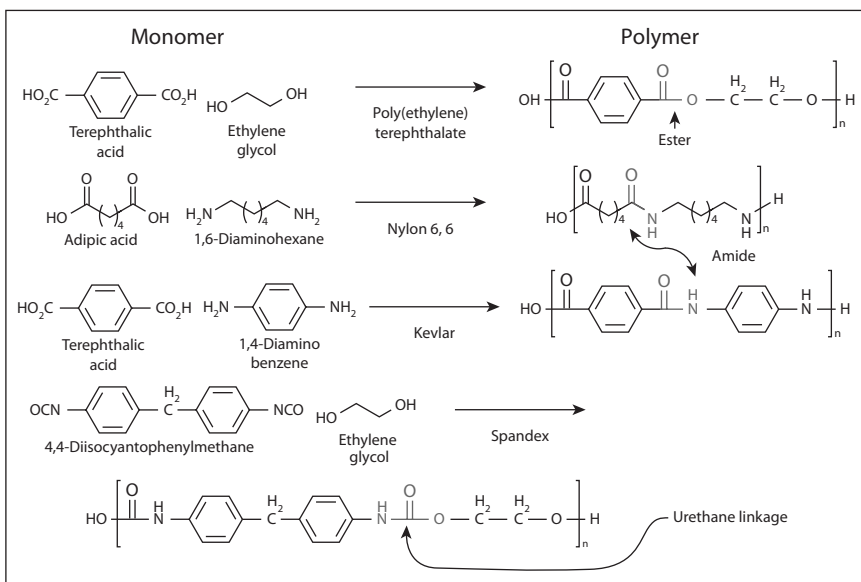
**Table 1.1** Nomenclature of linear polymers: families are defined by the types of chemical bond and by side groups present in polymers

Family	Repeating monomer unit	Side groups
Polyolefins	$-(\text{CH}_2\text{-CHR})-$	R = hydrocarbon group (H, CH <sub>3</sub> , ...)
Polyvinyls	$-(\text{CH}_2\text{-CHR}')-$	R' = group with heteroatom
Polyvinylidenes	$-(\text{CH}_2\text{-CR}'_2)-$	(F, Cl, O-CO-CH <sub>3</sub> , ...)
Polyacrylics	$-(\text{CH}_2\text{-CHR}'')-$	R'' = group based on carboxyl
Polymethacrylics	$-(\text{CH}_2\text{-C}(\text{CH}_3)\text{R}'')-$	(COOH, COOR, CN, CONHR, ...)
Polyethers	$-(\text{CHR-O-CHR})-$	
Polyesters	$-(\text{CHR-CO-O-CHR})-$	
Polyamides	$-(\text{CHR-CO-NH-CHR})-$	
Polycarbonates	$-(\text{CHR-O-CO-O-CHR})-$	
Polyurethanes	$-(\text{CHR-O-CO-NH-CHR})-$	
Polyureas	$-(\text{CHR-NH-CO-NH-CHR})-$	
Polysiloxanes	$-(\text{O-SiR}_2)-$	



**Figure 1.6** Common polyolefins and polyvinyls.

repeating units of poly(ethylene oxide) and poly(ethylene glycol) are similar, but the chain ends and lengths are different, due to the different methods of synthesis. Poly(ethylene terephthalate) is prepared from ethylene glycol and terephthalic acid. Polyamide-6 (Nylon-6) can be prepared from two different



**Figure 1.7** Polyesters, polyamides and polyurethanes.

**Table 1.2** Repeating monomer unit, chemical name, abbreviated name and density of some linear polymers

Repeating monomer unit	Chemical name	Abbreviation	Density (g/cm <sup>3</sup> )
<b>Polyolefins</b>			
$-(\text{CH}_2-\text{CH}_2)-$	Polyethylene	PE (HDPE and LDPE)	0.89–0.98
$-(\text{CH}_2-\underset{\text{CH}_3}{\text{CH}})-$	Polypropylene (polypropene)	PP	0.85–0.92
$-(\text{CH}_2-\underset{\phi}{\text{CH}})-$	Polystyrene	PS	1.04–1.06
$-(\text{CH}_2-\text{CH}=\text{CH}-\text{CH}_2)-$	1,4-Polybutadiene ( <i>cis-trans</i> )	PB	
$-(\text{CH}_2-\underset{\text{CH}_3}{\text{C}}=\text{CH}-\text{CH}_2)-$	1,4-Poly(isoprene) ( <i>cis-trans</i> )	PIP	0.92–1.00
<b>Polyvinyls and polyvinylidenics</b>			
$-(\text{CH}_2-\text{CHCl})-$	Poly(vinyl chloride)	PVC	1.38–1.41
$-(\text{CH}_2-\underset{\text{O-CO-CH}_3}{\text{CH}})-$	Poly(vinyl acetate)	PVAc	1.14–1.17
$-(\text{CH}_2-\text{CHOH})-$	Poly(vinyl alcohol)	PVAI	1.21–1.31
$-(\text{CH}_2-\text{CF}_2)-$	Poly(vinylidene fluoride)	PVDF	1.76
$-(\text{CF}_2-\text{CF}_2)-$	Polytetra-fluoroethylene	PTFE	2.10–2.30
$-(\text{CH}_2-\underset{\begin{array}{c} \text{N} \\ \diagup \quad \diagdown \\ \text{H}_2\text{C} \quad \text{C}=\text{O} \\ \diagdown \quad \diagup \\ \text{H}_2\text{C}-\text{CH}_2 \end{array}}{\text{CH}})-$	Poly( <i>N</i> -vinyl pyrrolidone)	PVP	

(continued opposite)

<b>Table 1.2 (continued)</b>			
<b>Repeating monomer unit</b>	<b>Chemical name</b>	<b>Abbreviation</b>	<b>Density (g/cm<sup>3</sup>)</b>
<b>Polyacrylics and polymethacrylics</b>			
$\begin{array}{c} \text{-(CH}_2\text{—CH)-} \\   \\ \text{COOH} \end{array}$	Poly(acrylic acid)	PAA	
$\begin{array}{c} \text{-(CH}_2\text{—CH)-} \\   \\ \text{COO—CH}_3 \end{array}$	Poly(methyl acrylate)	PMA	
$\begin{array}{c} \text{-(CH}_2\text{—CH)-} \\   \\ \text{H}_2\text{N—C=O} \end{array}$	Poly(acrylamide)	PAAm	
$\begin{array}{c} \text{-(CH}_2\text{—CH)-} \\   \\ \text{C}\equiv\text{N} \end{array}$	Polyacrylonitrile	PAN	1.14–1.17
$\begin{array}{c} \text{CH}_3 \\   \\ \text{-(CH}_2\text{—C)-} \\   \\ \text{COOH} \end{array}$	Poly(methacrylic acid)	PMAC	
$\begin{array}{c} \text{CH}_3 \\   \\ \text{-(CH}_2\text{—C)-} \\   \\ \text{COO—CH}_3 \end{array}$	Poly(methyl methacrylate)	PMMA	1.16–1.20
$\begin{array}{c} \text{CH}_3 \\   \\ \text{-(CH}_2\text{—C)-} \\   \\ \text{COO—CH}_2\text{—CH}_2\text{—OH} \end{array}$	Poly(2-hydroxyethyl methacrylate)	PHEMA	
$\begin{array}{c} \text{C}\equiv\text{N} \\   \\ \text{-(CH}_2\text{—C)-} \\   \\ \text{COO—C}_4\text{H}_9 \end{array}$	Poly(butyl cyanoacrylate) <i>n</i> -butyl Isobutyl	PBCA PiBCA	

(continued overleaf)



<b>Table 1.2 (continued)</b>			
<b>Repeating monomer unit</b>	<b>Chemical name</b>	<b>Abbreviation</b>	<b>Density (g/cm<sup>3</sup>)</b>
<b>From aldehydes and ring-opening polymerisation</b>			
$-(\text{CH}_2-\text{O})-$	Poly(methylene oxide)	PMO	
$-(\text{CH}_2-\text{CH}_2-\text{O})-$	Poly(ethylene oxide) Same unit as poly(ethylene glycol)	PEO (1 end OH) PEG (2OH)	
$-(\text{CH}(\text{CH}_3)-\text{CH}_2-\text{O})-$	Poly(propylene oxide)	PPO	
$-(\text{CH}_2-\text{CH}_2-\text{CH}_2-\text{CH}_2-\text{O})-$	Poly(tetramethylene oxide) or polytetrahydrofuran	PTMO	
$-(\text{CO}-\text{CH}_2-\text{O})-$	Poly(glycolide) or poly(glycolic acid)	PGA	
$-(\text{CO}-\text{CH}(\text{CH}_3)-\text{O})-$	Poly(lactide)s or poly(lactic acid)s	PLA	
$-(\text{CO}-\text{CH}_2-\text{CH}(\text{CH}_3)-\text{O})-$ $\text{CH}_3$ (C <sub>2</sub> H <sub>5</sub> )	Poly(hydroxybutyrate) (CH <sub>3</sub> ) Poly(hydroxyvalerate) (C <sub>2</sub> H <sub>5</sub> )	PHB  PHV	
$-(\text{CH}_2-\text{CH}_2-\text{CH}_2-\text{CH}_2-\text{CH}_2-\text{COO})-$	Poly( $\epsilon$ -caprolactone)	PCL	
$-(\text{CH}_2-\text{CH}_2-\text{CH}_2-\text{CH}_2-\text{CH}_2-\text{CONH})-$	Polyamide-6 (Nylon-6) Poly( $\epsilon$ -caprolactam)	PA-6	1.12–1.15
$-(\text{O}-\text{Si}(\text{CH}_3)_2-\text{O})-$	Poly(dimethylsiloxane)	PDMS	0.80
<b>Derivatives of two monomers (step polymerisation)</b>			
$[-(\text{CH}_2)_6-\text{NHCO}-(\text{CH}_2)_4-\text{CONH}]_n-$	Polyamide-6,6 (Nylon 6-6)	PA-6,6	1.13–1.16
$[-\text{CO}-\varphi-\text{COO}-(\text{CH}_2)_2-\text{O}]_n-$	Poly(ethylene terephthalate)	PET	1.38–1.41
$[-\text{O}-\text{CONH-R-NHCO}-(\text{O}-\text{CH}_2-\text{CH}_2)_n-]_n-$	Poly(ether urethane)s	PEU	
$[-\text{OCO}-(\text{CH}_2)_n-\text{COO}]_n-$	Polyanhydrides	PAnh	

monomers: the linear amino acid containing six carbon atoms or the cycle  $\epsilon$ -caprolactam, which is a condensation product of the amino acid.

### 1.4.2 Nomenclature of copolymers

When polymers are composed of at least two different repeating units, they are named copolymers. The order of the repeating units has to be specified, as different orders result in different properties. When two repeating units A and B are present in a linear copolymer, the order can be random. Such a copolymer is simply named poly(A-co-B) or sometimes poly(A-stat-B).

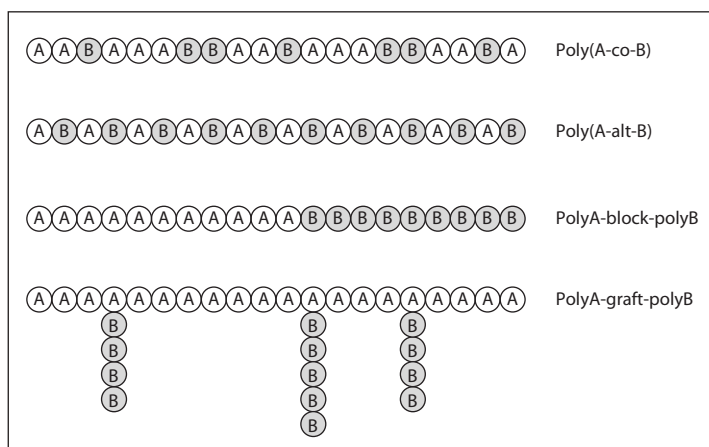
When one unit A is followed by one unit B, followed by one unit A, etc., the copolymer is alternate and named poly(A-alt-B), but it can also be named poly(A-B). Polyamide 6-6 (Nylon 6-6) is an example of a completely alternate copolymer: the monomer unit resulting from reaction of hexamethylene diamine is followed by the monomer unit resulting from the dicarboxylic acid containing six carbon atoms.

A block copolymer is composed of long blocks polyA and polyB present in a linear copolymer, e.g. a diblock polyA-block-polyB, a triblock polyA-block-polyB-block-polyA. When branches of blocks polyB are linked to a backbone polyA, with a different composition for backbone and branches, such a copolymer is a graft (or comb) copolymer and named polyA-graft-polyB, with the main chain named first. Examples are illustrated in Figure 1.8.

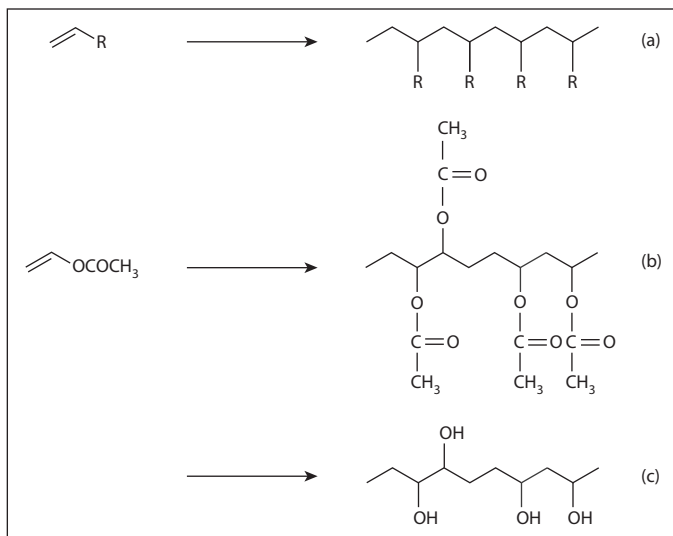
### 1.4.3 Isomerism and stereoisomerism

#### *Structural arrangement of repeating units*

During the course of chain polymerisation, head-to-tail linking is generally predominant, as illustrated in Figure 1.9.



**Figure 1.8** Types of copolymer: random, alternate, block and graft.



**Figure 1.9** Usual head-to-tail linking (a), irregularities in poly(vinyl acetate) (b) and in poly(vinyl alcohol) (c) resulting from hydrolysis of (b).

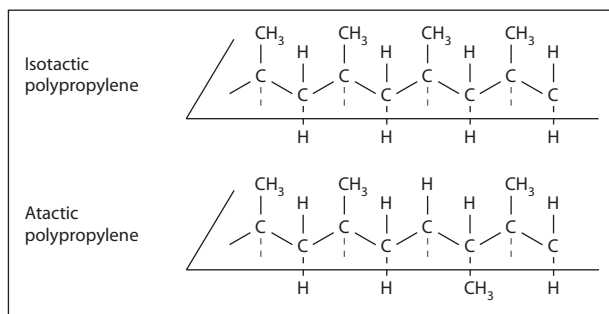
However, polymerisation of some monomers, for instance vinyl acetate, results in the presence of some irregularities, i.e. head-to-head and tail-to-tail linking, in the polymer chains. After de-acetylation, the resulting polymer, i.e. poly(vinyl alcohol), is composed mainly of 1,3-glycol units, but with some 1,2-glycol units, which are much more sensitive to oxidation, leading to the possibility of chain cleavage.

### Stereoisomerism

When a monomer bears two different atoms or groups of atoms on the same carbon of the double bond, three spatial configurations are possible for the polymer that is obtained. The spatial configurations depend on the geometry resulting from addition of the monomer on the active centre. This can be exemplified in the case of polyprop(yl)ene in Figure 1.10.

When the geometry of the active centre is the same at each addition of propylene, the spatial configuration is maintained and isotactic polypropylene is obtained. When the geometry changes at each addition, the spatial configuration is inverted each time and syndiotactic polypropylene is obtained. When the geometry is changed randomly, the spatial configuration is random and atactic polypropylene is obtained.

The consequences of these events are very important, as both the first spatial configurations possess a high regularity, whereas the last one is irregular. Because of the high spatial regularity, isotactic and syndiotactic polypropylenes can be endowed with a high crystallinity, resulting in very interesting mechanical properties, whereas atactic polypropylene remains amorphous, resulting in poor mechanical properties (see Sections 2.4.1 and 2.4.2).



**Figure 1.10** Stereoisomerism of polypropylene. Regular organisation in isotactic polypropylene can lead to highly crystalline materials, whereas the irregular organisation in atactic polypropylene cannot.

### Optically active polymers

As shown in Figure 1.11, there are two lactic acids. The L isomer is the natural one and the D isomer is obtained during synthesis in the racemic mixture, i.e. 50% L, 50% D.

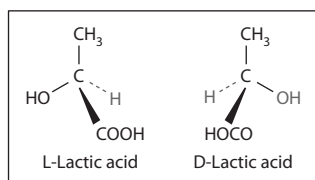
When starting from the L isomer and assuming that there is no racemisation during synthesis, poly(L-lactic acid) (PLLA) can be obtained. When starting from the racemic mixture, poly(D,L-lactic acid) (PLA50) is obtained. PLLA and PLA50 are illustrated in Figure 1.12.

The spatial configuration of PLLA is very regular, leading to the possibility of high crystallinity and a compact structure resulting in a slow hydrolysis rate. PLA50 is much more amorphous and its hydrolysis proceeds at a faster rate (see Section 4.2).

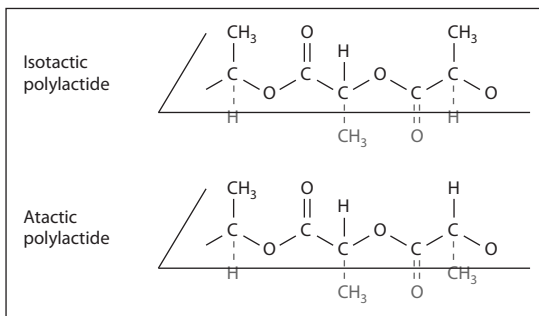
### Cis–trans isomerism

Polymerisation of dienes leads to four possibilities of linking and different spatial configurations, illustrated in Figure 1.13 in the case of poly(isoprene)s.

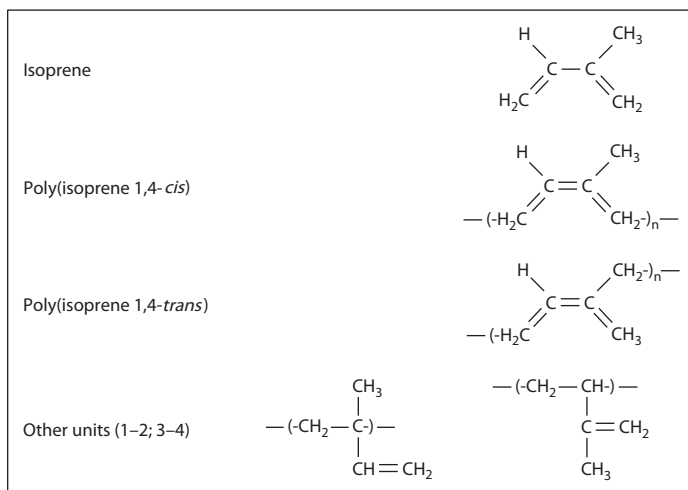
The different spatial configurations of the polydienes result in different properties. Natural rubber, which is extracted from latex of *Hevea brasiliensis* and is composed of 97–98% of 1–4 *cis* units with a few 3–4 units, is highly elastic. In contrast, the presence of a high proportion of 1–4 *trans* units in the



**Figure 1.11** The two types of lactic acid.



**Figure 1.12** Stereoisomerism of poly(lactides) or poly(lactic acids). Isotactic PLLA can be highly crystalline, whereas PLA50 cannot.



**Figure 1.13** *Cis-trans* isomerism of polyisoprene. The systematic name of isoprene is 1,3-butadiene, 2-methyl. Poly(isoprene 1,4-cis) is the main constituent of natural rubber. Poly(isoprene 1,4-trans) is the main constituent of gutta percha. Vinylic units (1-2) and (3-4) are present in synthetic rubbers.

latex of *Gutta percha* results in a much more rigid material used, for instance, for making golf balls. The 1-2 and 3-4 units are present mainly in some synthetic rubbers.

## Bibliography

### General

Allen G, Bevington JC, eds (1989). *Comprehensive Polymer Science*. London: Pergamon Press.

Brandrup J, Immergut JH, Grulke EA, eds (1999). *Polymer Handbook*, 4th edn. New York: John Wiley & Sons.

## **Nomenclature**

Metanomski WV, ed. (1991). *Compendium of Macromolecular Nomenclature*. Oxford: Blackwell Science.



# 2

## General characteristics of polymers

---

2.1 Characterisation of polymers	<b>20</b>	2.4 Properties of polymers as materials	<b>48</b>
2.2 Specific properties of polymers in the presence of liquid media	<b>35</b>	Bibliography	<b>53</b>
2.3 Relationships between structure of polymers and cohesion of materials	<b>44</b>		

---

In addition to properties shared with small molecules, macromolecules are endowed with specific properties that are linked to the length and organisation between molecules. Such specificities can be observed either in the presence of solvents or in solid state. For instance, polymolecularity is usually the rule and monomolecularity more the exception. Thus, molecular weight is usually an average; some methods used to determine the average molecular weights are presented in this chapter. As shown previously, most physical properties of polymers are independent of molecular weight. Dissolution of polymers in an adequate solvent can take a long (sometimes infinite) time and is always preceded by swelling of the chains. Unlike with metals, the probability of mixing together polymers to obtain alloys is generally low. Owing to the chain length and entanglement, the probability of spontaneous high long-range order inducing high crystallinity is low. A high level of crystallinity can be induced by further thermomechanical processes, in addition to structural requirements. As the thermomechanical processes are beyond the scope of this book, only the structural requirements are presented in this chapter.



## 2.1 Characterisation of polymers

In general, polymers for biomedical and pharmaceutical applications are characterised in order to determine their molecular weight, composition and thermal properties. All of these characteristics may influence the properties of the final device or medicine.

The molecular weight of polymers can vary from a few hundred to several million grams per mole, while cross-linked polymers have infinite molecular weight. Proteins that are obtained from biosynthesis are very homogenous. All molecules display the same molecular weight and composition because they are synthesised according to a well-programmed method by living organisms. However, despite the fact that they are also obtained by biosynthesis, polysaccharides are polymolecular and their composition can be heterogeneous. Polymers obtained from chemical synthesis form a family of macromolecular species characterised by a mean molecular weight with a certain distribution, termed the 'polymolecularity'.

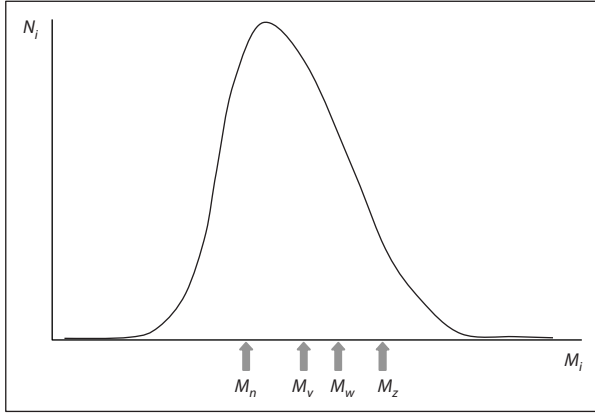
In the case of copolymers, the composition is also a mean composition that generally reflects the composition of the different co-monomers used in the polymerisation medium after total conversion of the monomers into polymers. However, because the reactivity of monomers between each other can be quite different, the composition of the different molecules of copolymers in a single preparation can vary. Indeed, composition in monomer units of the copolymers formed at the beginning of the polymerisation reaction is not necessarily the same as composition of the copolymers formed at the end of the polymerisation reaction. This effect adds heterogeneity to chemically synthesised copolymers, and the only way to appreciate this effect is to analyse the composition of the polymers at low conversion degree during polymer synthesis.

### 2.1.1 Determination of molecular weight of polymers

As mentioned above, polymers synthesised by chemistry are not identical but form a family of macromolecules of different lengths that can be characterised by a size distribution with a mean value of the molecular weight. A typical distribution graph of the size of polymer chains present in a sample and constituting a polymolecular population is illustrated in Figure 2.1.

The distribution in molecular weight of each population of macromolecules appears as a Gaussian curve. Mathematical analysis of such a distribution curve can provide different average values that can be used to characterise the molecular weight of the polymer and the distribution of the molecular weights in the population.

For instance, the first moment gives the number-average molecular weight,  $M_n$ . This corresponds to the total weight of the sample,  $W$ , divided by the number of molecules included in this amount of sample,  $N_i$ , as shown



**Figure 2.1** Typical graph illustrating distribution of molecular weight of polymers after synthesis by chemical methods.  $M_i$ , molecular weight of a given species;  $M_n$ , number-average molecular weight;  $M_v$ , molecular weight as determined from viscosimetric measurements;  $M_w$ , weight-average molecular weight;  $M_z$ , z-average molecular weight;  $N_i$ , number of chains having a given molecular weight.

in Equation 2.1. This average value is more sensitive to the presence of large amounts of small polymer chains.

$$M_n = \frac{W}{\sum_{i=1}^{\infty} N_i} = \frac{\sum_{i=1}^{\infty} N_i M_i}{\sum_{i=1}^{\infty} N_i} \quad (2.1)$$

The second moment gives the weight-average molecular weight,  $M_w$ . It can be calculated from Equation 2.2. In contrast to the number-average molecular weight, the weight-average molecular weight depends more on the number of molecules with a high molecular weight in the distribution.

$$M_w = \frac{\sum_{i=1}^{\infty} N_i M_i^2}{\sum_{i=1}^{\infty} N_i M_i} \quad (2.2)$$

The third moment of the distribution, which can be calculated from Equation 2.3, gives the z-average molecular weight, which is highly affected by the heaviest macromolecules.

$$M_z = \frac{\sum_{i=1}^{\infty} N_i M_i^3}{\sum_{i=1}^{\infty} N_i M_i^2} \quad (2.3)$$

In a heterogeneous population of polymer chains,  $M_n$  is always lower than  $M_w$ , and  $M_w$  is always lower than  $M_z$  (i.e.  $M_n < M_w < M_z$ ). The polymolecularity or polydispersity index (PI) can be defined to characterise the distribution in molecular weight of the population, as shown in Equation 2.4.

$$PI = \frac{M_w}{M_n} \quad (2.4)$$

The notion of polymolecularity is important because properties of polymers are affected in different ways by the distribution in molecular weight of the population of polymer chains, as indicated in Table 2.1. For instance, the thermodynamic properties depend more on the  $M_n$  of the polymer. In contrast, the bulk properties of polymers, especially those related to large deformations such as the viscosity and the toughness, are directly affected by the value of  $M_w$ . The melt elasticity depends more on  $M_z$ . Thus, the different average molecular weight can be determined by techniques based on the

**Table 2.1** Impact on polymer properties of the different average molecular weights and usual methods of determination

Average molecular weight	Impact on polymer properties	Methods of determination	Molecular weight range
$M_w = \frac{\sum_{i=1}^{\infty} N_i M_i^2}{\sum_{i=1}^{\infty} N_i M_i}$	Bulk properties associated with large deformation (viscosity, toughness)	*SEC coupled with light scattering Light scattering Small-angle X-ray scattering Centrifugation (Trautman's method)	To infinite **
$M_n = \frac{\sum_{i=1}^{\infty} N_i M_i}{\sum_{i=1}^{\infty} N_i}$	Most thermodynamic properties, depending on the number of molecules	*SEC *End-group analysis (chemical) *End-group analysis (NMR) *MALDI-TOF Osmometry Ebulliometry Cryometry	To infinite ** To $2 \cdot 10^4$ To $3 \cdot 10^3$ $4 \cdot 10^2 - 4 \cdot 10^5$ $2 \cdot 10^4 - 2 \cdot 10^6$ To $4 \cdot 10^4$ To $5 \cdot 10^4$
$M_z = \frac{\sum_{i=1}^{\infty} N_i M_i^3}{\sum_{i=1}^{\infty} N_i M_i^2}$	Melt elasticity	Centrifugation at sedimentation equilibrium	To infinite **

\* Most widely used methods.

\*\* The term 'to infinite' means that the method is suitable for the determination of the molecular weight of the largest macromolecules that can be solubilised in the solvent used for the measurement.

MALDI-TOF, mass spectrometry based on matrix-assisted laser desorption/ionisation-time-of-flight; NMR, nuclear magnetic resonance; SEC, size-exclusion chromatography.

measurement of either the thermodynamic properties (ebulliometry, cryometry, osmometry) for  $M_n$ , the bulk properties (light scattering, ultracentrifugation) for  $M_w$ , and the melt elasticity properties (ultracentrifugation) for  $M_z$ .

It can be seen that combining different techniques makes the determination of  $M_n$  and  $M_w$ , and hence PI, possible. A value of PI close to 1 indicates a very narrow distribution of the chain length around the average molecular weight values calculated from the distribution curve, while a PI value much larger than 1 indicates a wide distribution of the molecular weight of the polymer chains contained in the population.

The techniques used for determination of polymer molecular weight and polymolecularity have greatly evolved during the past 20 years. This progress was made possible thanks to the development of new chromatographic techniques combining several methods of detection at the outlet of the size-exclusion chromatography (SEC) column. This technique can be applied to determine the molecular weight of polymers within a very wide range of molecular weights, from a few thousands of grams per mole to several million grams per mole. The technique provides the full characterisation of the distribution in molecular weight in a single analysis. Other techniques that can now be found in laboratories are based on the dosage of the chain end groups when possible, on the application of a technique of a mass spectroscopy coupled with matrix-assisted laser desorption/ionisation (MALDI) detection for the smallest polymers capable of ionisation, and on the measurement of the intrinsic viscosity when the method is calibrated for the polymer to be analysed. These four major techniques of determination of polymer molecular weight are presented below.

### *Size-exclusion chromatography coupled with triple detection*

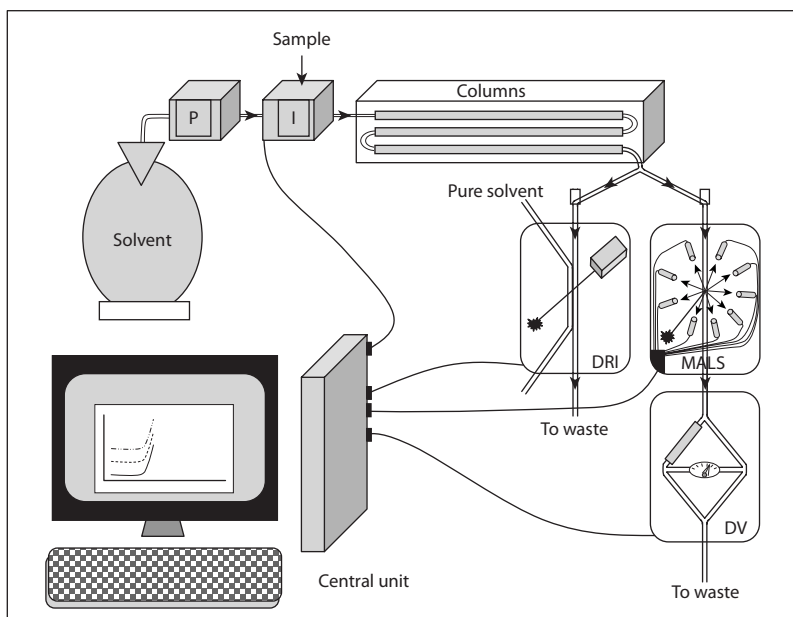
Size-exclusion chromatography is the simplest method that provides complete characterisation of the molecular weight of a polymer in a single analysis. This technique is based on the separation of polymers as a function of their molecular size through a size-exclusion column that is part of a chromatographic system. The system is composed of a pump providing a constant flow of mobile phase, an injector device equipped with an injection loop to introduce a defined volume of sample in the chromatographic setup, a series of size-exclusion chromatographic columns to ensure the separation step, a series of detectors to monitor the composition of the flow going out of the column, and a central unit that collects the data from the detectors and commands the whole chromatographic setup (injection, flow rate of mobile phase).

The choice of chromatographic column and the handling of the chromatographic setup are critical in order to provide accurate results. The chromatographic columns are chosen so that the molecular weight of the polymer sample is in the range of the optimal separation performance of the series of columns mounted on the SEC apparatus. In general, the chromatographic

columns are kept in the same solvent during their whole life. This often suggests that one chromatographic setup is reserved for one type of polymer analysis. The more common solvents used are tetrahydrofuran (THF), dimethylsulfoxide (DMSO), chloroform and water. These solvents are chosen from among those that dissolve a large range of polymers.

The use of a combination of three detection methods at the outlet of the chromatographic columns allows the determination of the molecular weight of a polymer without the need for calibration of the SEC columns. These detection methods include a differential refractive index (DRI) detector for the measurement of the polymer concentration in the eluate, a differential viscometer to evaluate the viscosity of the eluate, and a multi-angle light-scattering detector giving a direct measurement of the weight-average molecular weight of the polymer contained in the eluate. An example of the chromatographic setup used with triple detection is shown in Figure 2.2.

The system is coupled to the central unit of a computer to ensure coordination of injection of the sample and collection of the data coming from the three detectors. Software has been developed to assist the analysis given from the detectors and to calculate the different average molecular weights and the polymolecularity index of the analysed species. Other interesting parameters



**Figure 2.2** Typical setup of size-exclusion chromatography equipped with triple detection for determination of the molecular weight of polymers without the need for prerequisite calibration. DRI, differential refractive index detector; DV, differential viscometer; I, injector; MALS, multi-angle light-scattering detector (depending on the model, the scattered light is measured at 3 or 18 different angles); P, pump. The central unit includes a computer and software.

about the polymer dissolved in the solvent used for the analysis are given by the analysis. These parameters include the intrinsic viscosity, the Mark–Houwink–Sakurada coefficients and the refractive index increment.

One requirement is that the polymer needs to be fully soluble in a solvent compatible with the method. Polymer solutions need to be prepared very carefully, and the exact concentration should be known in order to perform the analysis. Generally, the concentration of the polymer used for such an analysis ranges from 0.1 mg/mL to 10 mg/mL. The polymer is left to dissolve for 24–48 hours before injection into the chromatographic system in order to ensure complete dissolution. The injection volume varies from 50  $\mu$ L to 100  $\mu$ L. Chromatographic columns are generally conditioned in solvents that dissolve many polymers such as THF, DMSO, chloroform or water. It is noteworthy that changing the solvent in a chromatographic setup is always a delicate operation and is generally not recommended, in order to preserve the performance of the columns and for the survival of the differential viscometer detector unit.

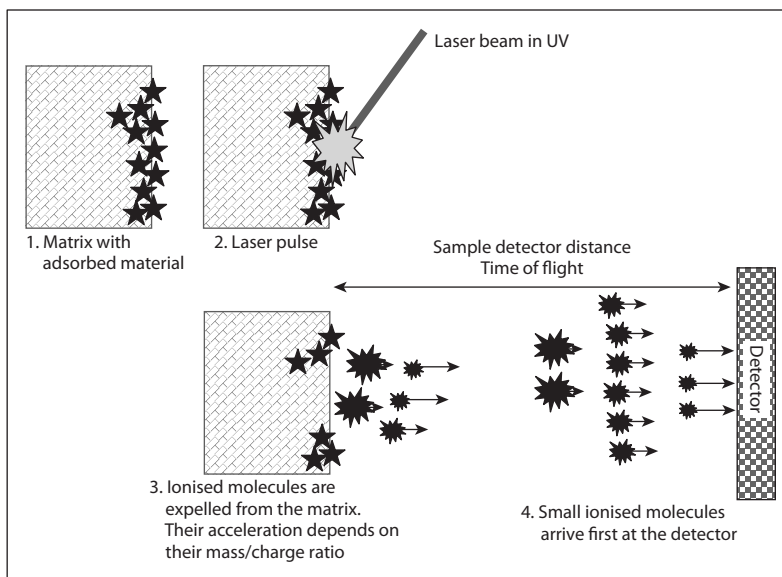
#### *Matrix-assisted laser desorption/ionisation–time-of-flight mass spectrometry*

Mass spectrometry based on matrix-assisted laser desorption/ionisation–time-of-flight (MALDI-TOF) can be used to determine the molecular weight of certain types of polymer up to a value of  $10^6$ . This method, which provides precise measurement of the number of molecules with a specific molecular weight, also gives information about the polymolecularity of the sample. It can also be used to highlight the presence of residual monomers and other compounds used during polymer synthesis.

The main parts of a MALDI-TOF apparatus are the sample holder, including a matrix, optic equipment with a laser, a detector and an analyser. A computer is connected to the apparatus to supervise the electronics of the instrument. Data collected from the detector are transferred to the computer unit. In practice, a solution of the polymer sample in a volatile solvent is adsorbed on the matrix. The deposition is performed using a spotting system, which allows the deposition of sample volume ranging from a couple of nanolitres to a few microlitres. The sensitivity of the detector is extremely high.

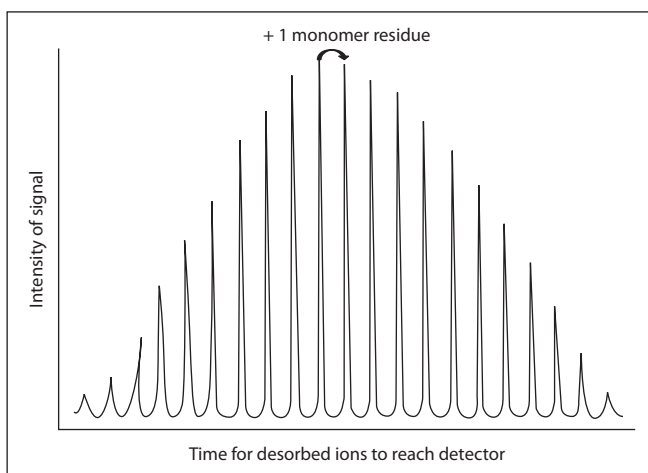
The basic principle of the method requires that the molecules to be analysed can be ionised in a gaseous phase after desorption from the matrix on which it was previously adsorbed. The energy that provokes desorption and ionisation of the species to be analysed is provided by a laser pulse working in the ultraviolet domain. Each ionised molecule coming from the sample and desorbed from the matrix has an acceleration that is inversely proportional to its own mass and proportional to its charge. This means that the smallest ions reach the detector first and the heaviest ions reach the detector last, as shown in Figure 2.3.

The response of the detector is sensitive to the number of ions detected at a certain time. The signal collected during this analysis shows a series of very

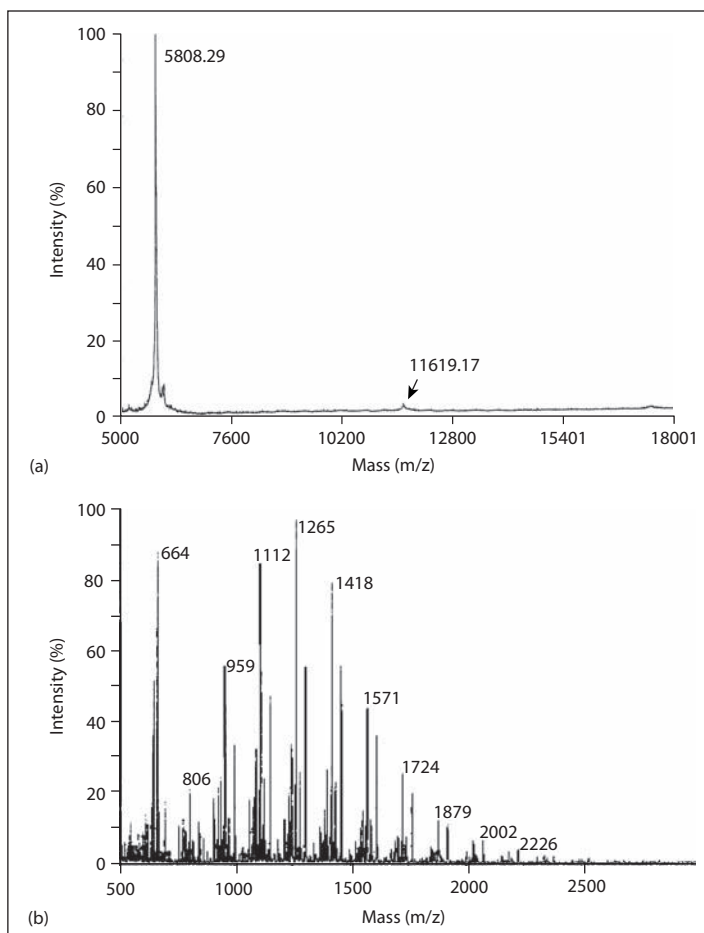


**Figure 2.3** Principle of MALDI-TOF determination of molecular weight of polymers.

thin peaks, each corresponding to the detection of a certain number of ions of the same mass. Thus, spectra of pure molecules and highly purified biopolymers show a single thin peak, while spectra from synthetic polymers can show molecules with molecular weights separated by the exact molecular weight to one monomer residue composing the polymer, as shown in Figure 2.4.



**Figure 2.4** Typical MALDI-TOF spectra obtained for a polymolecular sample of polymer. The intensity of the signal is proportional to the number of molecules detected. The time for desorbed ions to reach the detector after desorption from the matrix is related to the molecular weight/charge ratio ( $m/z$ ) of the ionic species.



**Figure 2.5** Example of MALDI-TOF spectra for a biopolymer, insulin (a), and for a synthetic polymer of poly(isobutylcyanoacrylate) (b).

Such a peak-to-peak resolution can be observed up to a molecular weight of the polymer of 20 000, but above this value spectra generally show continuous distribution. Typical mass spectra obtained from a biopolymer, insulin, and from a synthetic polymer, poly(isobutylcyanoacrylate), are shown in Figure 2.5.

As mentioned previously, this method can be applied only to polymers that can be ionised in the gaseous state. Another requirement is that the polymer needs to be molecularly adsorbed on the matrix, which means that the matrix and the polymer need to be compatible. The method is well adapted to the analysis of peptides, proteins and all synthetic polymers that can be ionised. The domain of application is not restricted to the characterisation of polymers and copolymers, including most of those developed for biomedical applications. MALDI-TOF can also be used to follow polymerisation reactions and



polymer degradation. It is also a useful tool for the determination of the composition and structure of copolymers. In practice, the method is fast and requires only a few milligrams of sample.

### *Chain-end analysis*

The number-average molecular weight can be determined from the dosage of end groups present in polymer chains. Suitable methods are those specific to the chemical group to be determined, including acidimetric titration and colorimetric methods for the simplest and more accessible groups. However, the method based on the analysis of  $^3\text{H}$  nuclear magnetic resonance (NMR) spectra can be considered the most accurate. First, this method is based on the determination of a clearly identified chemical group thanks to its position on the  $^3\text{H}$ -NMR spectra. Second, the quantitative determination of this specific end group can often be compared directly with the quantitative determination of another characteristic group included in the rest of the polymer chain, giving a direct ratio between the number of chain ends and the total number of monomer residues included in the polymer chains.

The main restriction for the application of this method is that the polymer should display a characteristic chain end. Additionally, this method can easily be applied to low-molecular-weight polymers, but the accuracy becomes questionable for polymers with a molecular weight above 20 000. It is also noteworthy that this method gives only a value of  $M_n$ , without any indication about the polymolecularity of the sample.

### *Viscosity*

The viscosity of polymer solutions depends on both the concentration and the molecular weight of the polymer. Thus, measurement of the viscosity of a solution of polymer can be a way to determine the molecular weight of the dissolved polymer. This can actually be the case providing that the coefficients  $K$  and  $\alpha$  of the Mark–Houwink–Sakurada equation (Equation 2.5) giving the relationship between the intrinsic viscosity of the polymer,  $[\eta]$ , and the viscosity average molecular weight,  $M_v$ , are known.

$$[\eta] = KM_v^\alpha \quad (2.5)$$

This also means that calibration is required in methods based on viscosity measurements before the method can be applied to characterise the molecular weight of a given polymer. Such calibration is tedious and requires that the molecular weights of a series of the polymer have been characterised by another technique in order to establish the relationship with the intrinsic viscosity. At present, this can be performed using the SEC method coupled with triple detection. It is noteworthy that calibration of the Mark–Houwink–Sakurada equation is valid only for one couple including a polymer and a solvent at a given temperature.

In practice, the intrinsic viscosity of a polymer in solution can be deduced from the reduced viscosity,  $\eta_{red}$ , of a series of solutions of the polymer at different concentrations,  $C$ , and extrapolation back to zero polymer concentration, as shown in Equation 2.6.

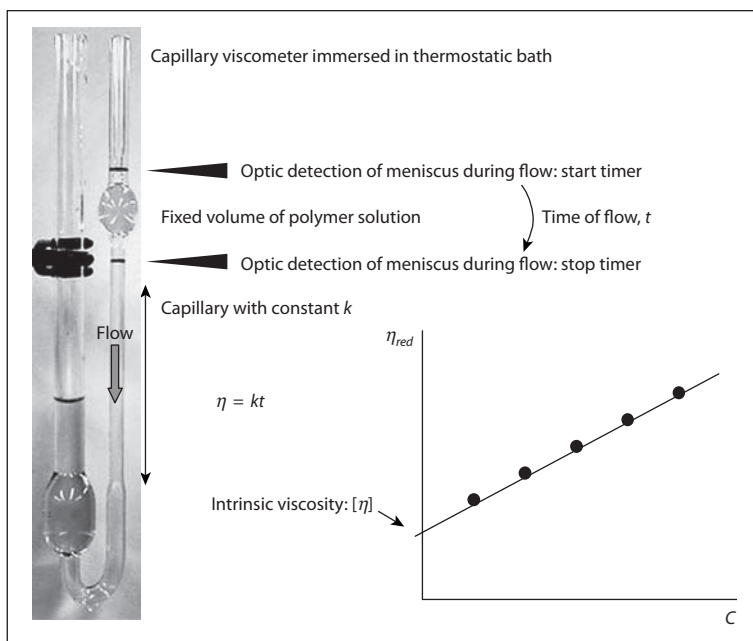
$$[\eta] = \eta_{red \ C=0} = \frac{(\eta - \eta_0)}{\eta_0 C} \quad (2.6)$$

The reduced viscosity of a polymer solution can be obtained from measurements of the viscosity of the polymer solution,  $\eta$ , and of the viscosity of the corresponding solvent,  $\eta_0$ , using a capillary viscometer.

In practice, the viscosity of the solvent and of five to six solutions of the polymer dissolved in the same solvent at different concentrations is measured in a capillary viscometer. This is performed by measuring the flowing time of a defined volume of sample through a capillary of well-known characteristics, which are given as constant associated with a single capillary. The relationship between the flowing time measured and the viscosity is given by Equation 2.7.

$$\eta_{red} = \frac{(t - t_0)}{t_0 C} \quad (2.7)$$

The capillary is part of an apparatus whose major role is to measure very precisely the time of flow of the samples using an electronic device. A scheme of such a viscometer is given in Figure 2.6. From the measurements



**Figure 2.6** Scheme of a capillary viscometer and principle of determination of the intrinsic viscosity of polymers.

given by the capillary viscometer, a graph giving the reduced viscosity as the function of polymer concentration can be drawn, as shown in this figure.

The usually expected straight line is extrapolated back to zero polymer concentration in order to obtain the intrinsic viscosity of the polymer dissolved in this solvent. The value is then used to calculate the molecular weight of the polymer through the Mark–Houwink–Sakurada equation.

Some precautions need to be taken during these measurements, such as having a very clean capillary and using solutions without dusts. Indeed, dusts slow down the flowing of the solutions, which leads to erratic results. Another precaution is related to the high fragility of the capillary, which can be broken very easily during handling.

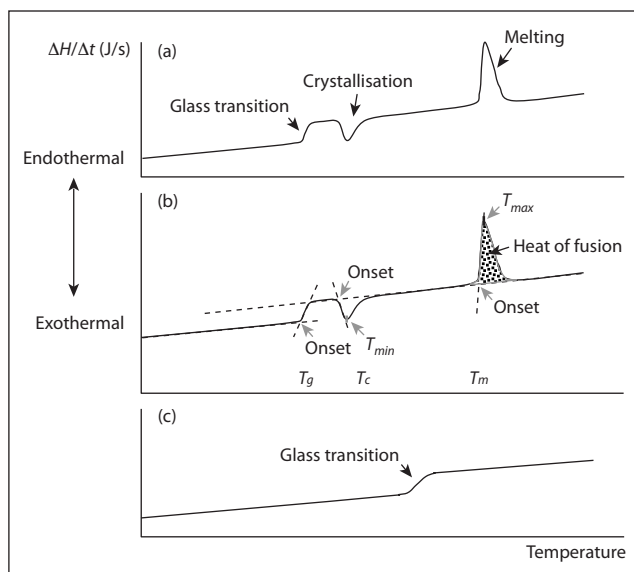
### 2.1.2 Determination of thermal properties of polymers

The thermal properties of polymers are important parameters to consider as they play key roles in the mechanical properties of biomaterials used in bone repair and prosthesis materials. These properties may also influence the drug-release properties of drug-delivery devices. Information is provided about the mobility of the polymer chains within a material at a given temperature and about the crystallinity of this material (see also Section 2.4). This characterisation is also useful in order to determine whether a polymer material is a hard or soft solid or a liquid at a given temperature.

In general, the thermal properties of polymers are investigated using a calorimetric method. The most used method is differential scanning calorimetry (DSC), which consists of measuring the difference in energy input or of heat flow between a sample and a reference material when both are subjected to controlled heating and cooling programmes. The measured energy differential corresponds to the heat content or enthalpy or specific heat of the sample. In general, a polymer sample of known weight (typically 10 mg) is placed in a sealed aluminium pan. The reference corresponds to an empty aluminium pan of the same type. The empty pan is used to maintain a zero temperature differential between the sample and the reference during programmed heating and cooling temperature scans so that it allows monitoring of endothermic or exothermic events occurring in the sample pan.

This technique is most often used to determine the glass transition temperature ( $T_g$ ), the melting temperature ( $T_m$ ), the crystallisation temperature ( $T_c$ ), and the heat of fusion of the polymers.  $T_g$ ,  $T_m$  and the heat of fusion are measured during the heating scan, while  $T_c$  is evaluated during the cooling scan, as shown in Figure 2.7.  $T_m$  and  $T_c$  are apparent only in crystalline polymers, whereas  $T_g$  is apparent in the amorphous domains of the polymers.

The heat of fusion can be used to evaluate the degree of crystallinity of a polymer. In general,  $T_g$  is detected as a step on the base line of the thermogram. During the heating scan, this event corresponds to the transition from a



**Figure 2.7** Typical differential scanning calorimetry (DSC) thermograms of polymers obtained during heating scans at 10–20°C/min: (a) DSC thermogram of a semi-crystalline polymer; (b) same thermogram showing the methods to determine the different parameters; (c) thermogram of an amorphous polymer.

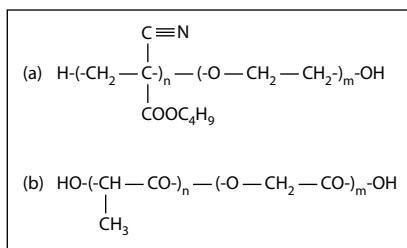
disordered rigid solid to a more flexible one. All polymers have a  $T_g$ , but it can be very difficult to detect because this transition indicating the change in mobility regime of the polymer chains in a solid is often a weak event. The more sensitive apparatus found on the market suits the characterisation of weak  $T_g$ ; it also permits analysis at a high speed, allowing the analysis of many samples in a short time.

### 2.1.3 Determination of composition of copolymers

Copolymers are composed of at least two types of monomer unit. Although it can be expected that the composition of copolymers fits well with the composition of the different monomers used during copolymer synthesis, there are different reasons inherent to polymerisation reactions that can explain why the composition of the copolymer can differ from the initial composition of the copolymerisation medium (see Section 3.8). For this reason, the composition of copolymers needs to be determined in the routine characterisation of such a type of polymer. The most widely used methods for this are those based on the elemental analysis or on spectral analysis of the copolymer.

#### *Determination of copolymers composition by elemental analysis*

The principle of elemental analysis is to determine the percentage of each type of atom included in a compound. The composition of the copolymer is then



**Figure 2.8** Chemical structures of a block copolymer poly(alkylcyanoacrylate)-block-poly(ethylene glycol) (a), and of a random poly(lactic acid-co-glycolic acid) copolymer (b).

compared with the composition of homopolymers made with the different corresponding co-monomers. If the copolymers are composed of the addition of  $x\%$  of monomer A,  $y\%$  of monomer B,  $z\%$  of monomer C, . . . , then the values of  $x$ ,  $y$  and  $z$  are calculated from the sets of data provided by the elemental analysis of both the copolymers and the corresponding homopolymers.

As a first example, determination of the composition of a block copolymer made of poly(isobutylcyanoacrylate) and poly(ethylene glycol) blocks (PIBCA-PEG), shown in Figure 2.8a, is presented in Table 2.2. In this copolymer, the monomer unit of the PIBCA part includes carbon, oxygen, hydrogen and nitrogen atoms, while the monomer unit of the PEG part includes carbon, oxygen and hydrogen atoms.

In the copolymer, the nitrogen atom can only be attributed to the contribution of the isobutylcyanoacrylate monomer units, making calculation of the composition of the copolymer easier. Indeed, composition of the copolymer can be deduced from the content in nitrogen. To do this calculation, it is postulated that the amount of nitrogen found in the copolymer ( $N_{\text{copolymer}}$ ) comes from  $x\%$  of PIBCA plus  $y\%$  of PEG, as shown in Equation 2.8.

$$N_{\text{copolymer}} = X N_{\text{PIBCA}} + Y N_{\text{PEG}} \quad (2.8)$$

**Table 2.2** Determination by elemental analysis of the atomic composition of a block copolymer poly(isobutylcyanoacrylate)-block-poly(ethylene glycol) (PIBCA-PEG) and of the corresponding homopolymers; from these data, it can be calculated that the copolymer is composed of 77% PIBCA and 23% PEG

Atom	Copolymer (g%)	PIBCA (g%)	PEG (g%)
C	61.1	63	55
H	7.4	7	9
O	24.5	21	36
N	7	9	0

**Table 2.3** Determination by elemental analysis of the atomic composition of a copolymer of poly(lactic acid-co-glycolic acid) (PLGA) and of the corresponding homopolymers; from these data it can be calculated that the copolymer is composed of 70% PGA and 30% PLA

Atom	Copolymer (g%)	PGA (g%)	PLA (g%)
C	54.2	56	50
H	6.5	7	5.5
O	39.25	37	44.5

Taking the amount of nitrogen found in the copolymer,  $N_{\text{copolymer}} = 7$ , the amount of nitrogen found in the PIBCA part,  $N_{\text{PIBCA}} = 9$ , and the amount of nitrogen found in the PEG part,  $N_{\text{PEG}} = 0$ , and then applying Equation 2.8, it can be deduced that the copolymer contains 77% of PIBCA and hence 23% of PEG.

Determination of the composition of copolymers made of two monomers including the same atoms in their structures but with different compositions is presented as a second example, shown in Table 2.3. This example is based on a random copolymer of poly(lactic acid-co-glycolic acid) (PLGA), shown in Figure 2.8b.

One can take any of the atom compositions of the copolymer. In the example, Equation 2.9 was written for carbon contribution. Because the sum of  $x + y$  is equal to 1, we can deduce that  $x = 1 - y$ . The value of  $x$  can be replaced in Equation 2.9, which allows us to determine  $y$ . The same approach can be repeated with the composition of oxygen and of hydrogen atoms. The values of  $x$  and  $y$  deduced from each atom should be the same as those initially deduced on the basis of the data coming from the composition of carbon.

$$C_{\text{copolymer}} = X C_{\text{PGA}} + Y C_{\text{PLA}} \quad (2.9)$$

### *Determination of copolymer composition by spectroscopic methods*

All spectroscopic methods allowing the identification of chemical structures and the quantitative determination of identified chemical functions can be used to determine the composition of a copolymer. Nuclear magnetic resonance is by far the most used method for this purpose, but infrared and Raman spectroscopy can also be used.

The use of NMR spectra requires that high-resolution  $^1\text{H-NMR}$  spectra can be obtained from the analysis of the copolymer and that each of the constituting monomers has a specific chemical group resolved by this method as a separate peak. In general, high-resolution spectra can be obtained by

analysing the copolymer after its complete dissolution in a suitable deuterated solvent. Full dissolution is highly recommended in order to obtain spectra showing thin, well-defined peaks. Determination of the fraction of the different monomer units included in the copolymer is then deduced from the relative intensity of the peak characterising each type of monomer unit. It is noteworthy that this method can be applied only if each monomer unit composing the copolymer shows a characteristic proton resolved in the NMR spectra. NMR can also be used to investigate the structure of copolymers; for instance, the sequence of co-monomers, the size of blocks and the branching of copolymers can be determined by high-resolution NMR.

In infrared spectroscopy, infrared spectra are collected from cast films by passing a beam of infrared light through the sample. Examination of the transmitted light reveals how much energy is absorbed at each wavelength. Analysis of the absorption bands at characteristic wavelengths or frequencies reveals details about the molecular structure of the sample, since the frequency of the vibration can be associated with particular bond types included in the molecular structure of the analysed sample. The number of absorption bands increases with the complexity of the molecule. Although for simple polymers the identification is ideally made by infrared spectroscopy, more difficulties may arise in more complex polymers, including copolymers. An alternative technique termed attenuated total reflectance infrared spectroscopy (ATR-IR) enables spectra to be obtained directly from solid or liquid samples without further preparation. The main limitation of the wide application of infrared spectroscopy is the lack of reference spectra for polymers, which has hampered the development of this technique in copolymer composition analysis.

Raman spectroscopy is complementary to infrared spectroscopy. It differs from the latter by the fact that Raman bands arise from an oscillating induced dipole caused by light waves interacting with the polarisability ellipsoid of a vibrating molecule. In Raman spectroscopy, the sample, which requires little or no preparation, is illuminated by a monochromatic light source and the spectrum is obtained from a very small amount of light scattered by the samples (about  $10^{-5}\%$  of the incident light intensity). This part of the scattered light is shifted in energy from the laser frequency of the incident beam due to interactions between the incident electromagnetic waves and the vibrational energy levels of the molecules in the sample. In this fraction of scattered light, the band positions lie at frequencies that correspond to the energy levels of different functional group vibrations composing the molecule. Raman spectra can thus be interpreted similarly to infrared absorption spectra. Raman spectra are plotted with respect to the incident source frequency, which appears as a band of maximum intensity of scattered light. This band, also termed the Rayleigh diffusion, corresponds to the largest fraction of scattered light that has the same frequency as the incident source. It serves as a reference to set the

scale at  $0/\text{cm}$ . In general, Raman bands can be easily attributed to a chemical structure. The spectra are very specific and are cleaner than infrared spectra. Raman bands are narrower and overlap, combination bands are generally weak, and chemical identifications can be performed by using search algorithms in digital databases. Raman spectroscopy can be used to measure bands of symmetric linkages that are weak in an infrared spectrum (e.g. -S-S-, -C-S-, -C=C-). Other advantages include the fact that water and  $\text{CO}_2$  vapours are very weak scatterers – hence, purging is unnecessary and no special accessories are needed for measuring polymers dissolved in aqueous solutions. It is believed that in many cases Raman spectroscopy may be superior to infrared spectroscopy and may provide a better answer to polymer analysis problems.

## 2.2 Specific properties of polymers in the presence of liquid media

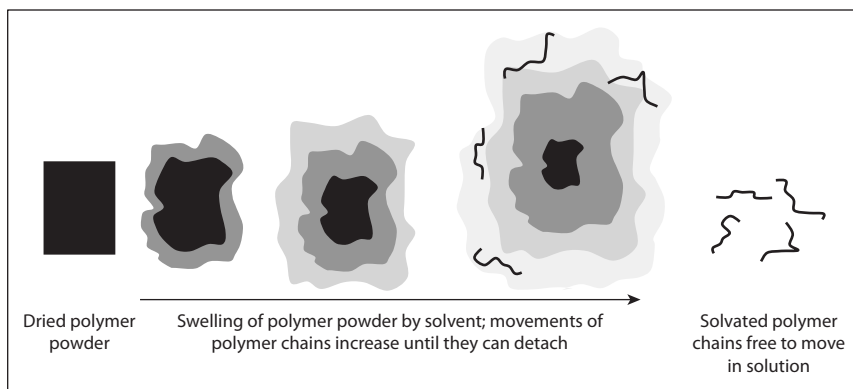
In liquid media, polymers can be found in three states, depending on various parameters. Full dissolution can be obtained in appropriate solvents when the concentration and molecular weight are in the proper range to allow complete solubilisation. Polymers form gels when the concentration is high, when the molecular weight is very high (e.g. after cross-linking), or when the polymer can form liquid crystals resulting from the self-organisation of the polymer chains thanks to their nature and structure. Polymers can be dispersed as tiny particles of insoluble material to form colloidal suspensions. Polymers incorporated in all these systems can confer unique properties, for instance to improve the performance of drug-delivery formulations or to provide drug-delivery formulations with specific properties. As will be discussed later in this chapter, the use of polymers formulated in solution can greatly facilitate the process of fabrication of pharmaceutical formulations.

### 2.2.1 Polymer solutions: preparation and properties

Polymer solutions are obtained by complete dissolution of the macromolecule into a solvent. As in any case of dissolution of a solute in a solvent, dissolution phenomena are controlled by the balance between, on the one hand, solute–solute and solvent–solvent interaction forces and, on the other hand, solute–solvent interaction forces. Thus, general thermodynamic considerations, including solubility parameters and cohesive energy density notions, can help us to predict whether or not a polymer can be soluble in a given solvent. Nevertheless, solubilisation of a polymer in a suitable solvent is a more complex phenomenon than solubilisation of a small molecule, and it generally takes a long time because it requires several steps.

As illustrated in Figure 2.9, swelling of the dried polymer powder by the solvent is the first step; this is a slow process. During swelling, mobility of the polymer chains increases, resulting in increased freedom. In a second step,





**Figure 2.9** Dissolution of a polymer in a suitable solvent.

polymer chains that have gained enough mobility and freedom are detached from the swollen polymer. This finally leads to complete solubilisation, which is obtained when the solvated chains are individualised in the solution.

Solubilisation is also affected by several parameters inherent to the polymer itself. For instance, the rate of the initial stage of swelling is influenced by the glass transition temperature,  $T_g$  (see Section 2.3.3), which is related to the mobility of the polymer chains in the solid state. Swelling of a polymer endowed with a  $T_g$  lower than the solubilisation temperature starts much more rapidly than swelling of polymers with a high  $T_g$  in which the chains are mainly immobile. The molecular weight of the polymer is also an important parameter that controls the rate of dissolution. Low-molecular-weight polymers dissolve faster than large macromolecular chains.

It is noteworthy that some polymers have a very narrow window of solubilisation in some solvents. Poly(ethylene glycols) and their derivatives, which are used widely in pharmaceutical formulations, are among such polymer species. In general, these are highly soluble in water but they can also dissolve in some organic solvents. In aqueous solvents, their solubilisation results in the formation of hydrogen bonds with the surrounding water molecules. Because of this solubilisation mechanism, they are only soluble below a given temperature, which can vary by the addition of small solutes such as ions or sugars in the aqueous dissolution medium. Thus, such polymers may be not soluble above 30 °C but they may be perfectly soluble at room temperature. This may be an important parameter to consider, as most preparations are performed at room temperature but the human *in vivo* temperature is 37 °C. When using such polymers and copolymers in formulation of a solution, it is important to check systematically whether the PEG-containing compound soluble at room temperature will become insoluble at body temperature. Conversely, such temperature-dependent behaviour can be taken advantage of, e.g. for obtaining temporary embolisation or jellifying eye drops (see Section 4.1.1). This is typically the case for aqueous solutions of

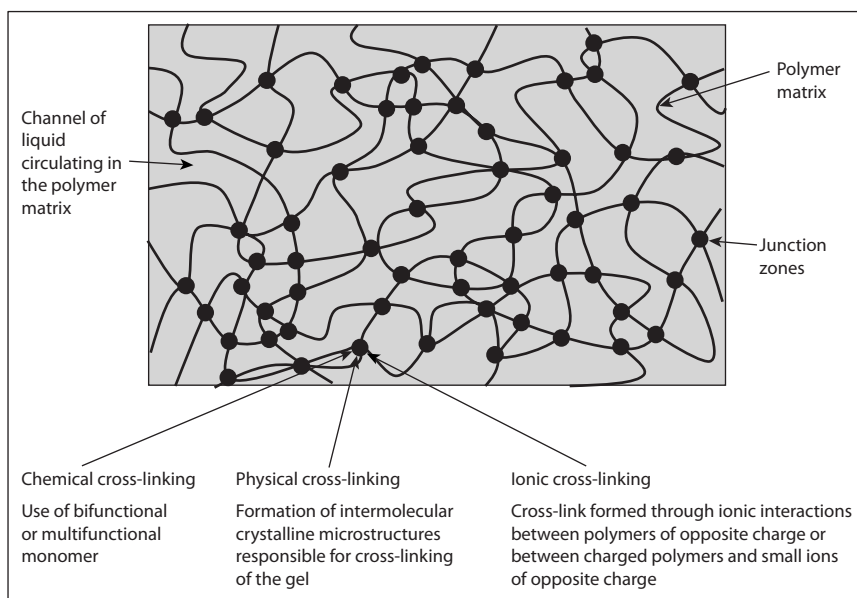
poloxamer 407, which are liquid below 25 °C and form a gel at higher temperatures.

Adding polymers to a solution confers new physicochemical properties to the solution. In pharmaceutical formulations, the property that is used is the increase in viscosity. Indeed, the viscosity of a polymer solution is influenced directly by both the concentration of the polymer and its molecular weight. Relationships between the viscosity of the solution and the polymer concentration and molecular weight can be found in Section 2.1.1.

Another property of polymers in the solubilised state that may be interesting for pharmaceutical formulations is a property specific to amphiphilic copolymers (see Section 4.1.1). Such copolymers can be used to formulate stable dispersions and emulsions. In general, they are highly efficient surfactants. Their critical concentration for micelle formation (CMC) is much lower, e.g. about 0.005 wt% in water, than the CMC of low-molecular-weight surfactants, e.g. 0.2 wt% for sodium dodecylsulphate.

## 2.2.2 Gels and hydrogels

Gels can be formed with various polymers. The polymer forms the backbone of a cross-linked matrix including channels filled with a liquid phase, as shown in Figure 2.10. Depending on the nature of the polymer forming the



**Figure 2.10** Schematic representation of the structure of a gel. The black lines show the polymer chains forming the matrix of the gel. The black dots represent the cross-linking zones that can result from different mechanisms of gel formation. The grey colour of the background represents the liquid phase filling the channels formed in the matrix of polymer.

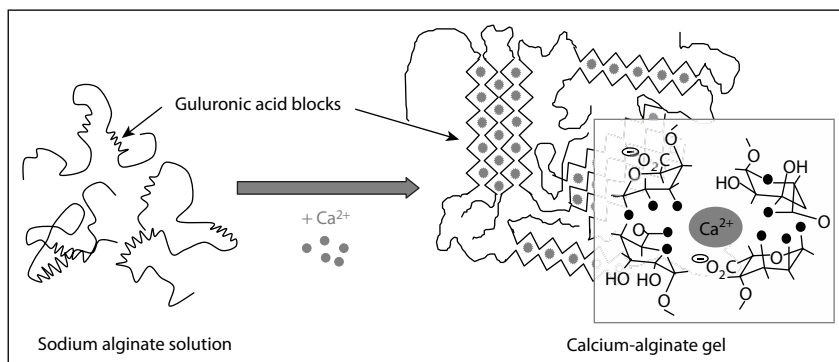
matrix, and on its affinity for given types of solvent, gels can be obtained with either an organic or an aqueous liquid phase. In the latter case, they are named hydrogels. Swelling properties of hydrogels are linked both to the affinity of the polymeric backbone for a solvent and to the degree of cross-linking. If the polymeric network is cross-linked enough to be insoluble, but not too much to be able to swell, then the general shape of the material is kept; however, its total size increases.

In many cases, gels are mainly composed of the liquid phase, which can represent more than 90% of the total composition. However, some hydrogels contain less water, as shown in the case of poly(2-hydroxyethylmethacrylate) (PHEMA). Thanks to the presence of the polymeric network, the internal viscosity of hydrogels is high, resulting in structural strength, decreased resistance to sliding, and decreased permeability to large molecules, making their retention possible. The main characteristic of the liquid phase is that it is not able to flow, because it is trapped in the channels formed by the polymer chains. However, this liquid can be used to dissolve components in the gel, or it can be used for chemical reactions.

Many natural hydrogels are known to be constituents of the extracellular matrix, mucin, glyocalix and so on. Jelly is a well-known example of the use of hydrogels in food. Hydrogels can be obtained from many hydrophilic polymers, either natural (e.g. cellulose, dextran, alginate, hyaluronic acid, chitosan, pectin) or synthetic (e.g. poly(vinyl alcohol) (PVA), PEG, poly(vinyl pyrrolidone) (PVP), PHEMA, polyacrylamides).

Different types of gel have been described according to their mechanism of formation, as shown in Figure 2.10. The use of bifunctional or multifunctional monomers during polymer synthesis leads to permanent chemical cross-linking of polymers with almost infinite molecular weight. Cross-linked polymers cannot be dissolved but can only swell to form gels in appropriate solvents. Poly(acrylamide) gels used in biochemistry for analysis of proteins by gel electrophoresis are a typical example of chemically cross-linked gels. Polymerisation of the simple monomer, i.e. acrylamide, in water leads to formation of linear poly(acrylamide), which is highly soluble in water even at very high molecular weight ( $10^6$  g/mol). However, by addition of a small amount of a bifunctional monomer, e.g. bis-acrylamide, in the polymerisation medium, a solid gel is formed, entrapping the water used for the polymerisation reaction.

A second method that can be used to obtain chemically cross-linked polymers is to start with a linear polymer containing free chemical groups that can be used to react with a cross-linking agent. A typical example of such a polymer, which is widely used as an excipient in the pharmaceutical industry, is poly(acrylic acid). As many carboxylic acid groups are available along the polymer chain, poly(acrylic acid) can be cross-linked by any component containing for instance at least two hydroxyl groups in their structure. In practice,



**Figure 2.11** Ionic gel formed from alginate.

cross-linking can be achieved by using sugars or glycol derivatives. In both cases, the mesh size of the polymer matrix forming the gel is controlled by the amount of cross-linking agent. Properties of the gel are conditioned by this important parameter.

Another cross-linking method is based on the formation of ionic bonds between polymers of opposite charges or between charged polymers and small molecules of opposite charges. A very popular example of such a gel is illustrated by the polysaccharide alginate. This natural polymer extracted from brown seaweeds is composed of guluronic acid and manuronic acid units. The gelling property is due to the oligoguluronic acid segments or blocks included in the structure of the polymer, as shown in Figure 2.11. In the presence of calcium, oligoguluronic blocks can be organised in crystalline-like structures in the presence of calcium ions. The calcium ion fits in the guluronic blocks as eggs in an egg box, forming highly compact junction zones as ionic cross-linking points of the gel structure. Such hydrogels have also been proposed to encapsulate enzymes and even cells.

Several polymers are able to form gels by ionic gelation controlled by the pH of the external medium. Gels are formed by pectin, another polysaccharide, in acidic medium. In contrast with the gels obtained by covalent cross-linking methods, ionic gels are reversible. In the case of the calcium alginate gels, calcium can be displaced by using both a monovalent cation such as sodium and a complexing agent able to trap the released calcium.

Poly(methacrylic acid) and its derivatives are other polymers with pH-dependent swelling. Poly(methacrylic acid) is barely hydrophilic, whereas its sodium salts are easily dissolved in water. This property is used to prepare gastro-resistant coatings for tablets. Cross-linked poly(methacrylic acid) does not swell at low pH, but its salts swell above pH 6. Such polymers and copolymers have been used as matrices for intestinal controlled delivery of drugs. Conversely, linear polymers bearing amino groups are water-soluble at low pH, whereas cross-linked polymers are swollen. Gastro-soluble and

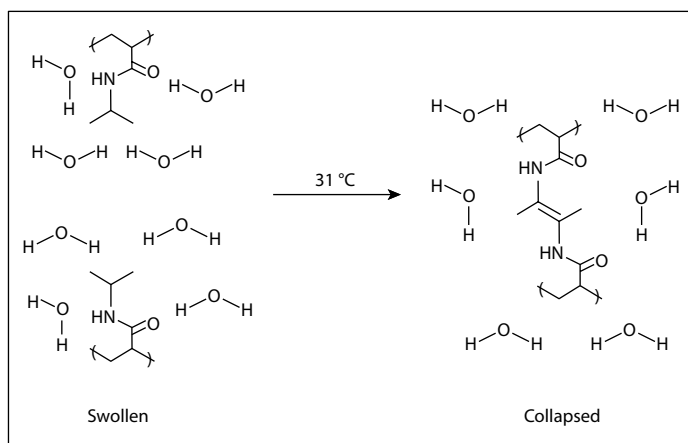
gastro-resistant derivatives of poly(methacrylic acid) have been developed under the trade name Eudragit<sup>®</sup> (see Section 4.4.2).

There are many other physicochemical mechanisms that can result in the formation of gels from polymer solutions. Indeed, polymer gels may also be obtained by formation of hydrogen bonds, hydrophobic interactions and formation of crystallised domains. This is the case for cellulose, which is highly crystalline and swells into water without dissolving, despite the fact that it is not chemically cross-linked. On the other hand, dextrans, which are also polymers of glucose, are water-soluble when non-cross-linked. Cross-linked forms, known as Sephadex<sup>®</sup>, are well known as beads with various degrees of swelling.

The sol-gel transition can be induced by various physicochemical parameters, such as the temperature, the concentration in salt in the solution and the pH. Poly(*N*-isopropylacrylamide) (PNIPAm) exhibits a thermosensitive transition. Below 31 °C, the polymer is hydrophilic and swollen by water. Above this temperature, the polymer is hydrophobic and the network collapses, as shown in Figure 2.12. Such temperature-dependent behaviour can be of great interest.

Other mechanisms are based on stereo-complexation, self-assembling and host-guest interactions. In certain cases, the simple mixing of two polymers with complementary assembling functionalities is enough to obtain the formation of a gel; for instance, polymers containing cyclodextrins as a host for hydrophobic compounds are able to form gels via this mechanism. In the presence of a second polymer containing hydrophobic compounds able to form complexes with the host cavity of the cyclodextrins, gels can be readily formed.

Many polymers forming gels according to these mechanisms are tailor-made copolymers that can be designed in a very precise way in order to form



**Figure 2.12** Thermal sensitive hydrogels of poly(*N*-isopropyl acrylamide) (PNIPAm).

gels under defined physicochemical conditions. In general, the gels formed are reversible and can be obtained with very specific properties. Because of the stringent conditions required for their formation, interest in them is growing for the development of new applications in drug-delivery formulations. For instance, many amphiphilic copolymers can form liquid crystals thanks to the supramolecular arrangements of polymer chains in an ordered orientation. Such gels behave in some ways like liquids and in some ways like solids. They include thermotropic phases that undergo phase transition at a very precise temperature and lyotropic phases that undergo phase transition at a very precise temperature and polymer concentration. Thus, they may be suitable for developing stimuli-responsive drug-delivery systems. Another interesting area is the development of formulations administrable as a liquid form but that solidify as a gel to form a solid depot at the administration site as soon as the formulation is in contact with the biological medium. A typical application is the development of eye-drop formulations in which the solution is converted into a gel in contact with the cornea, hence prolonging the residence time of the drug on the surface of the ocular mucosa. Examples of polymers capable of forming gels according to the mechanisms described above are PEG-containing copolymers, which can be used for many applications in pharmacy. Agarose and agar-agar are polysaccharides that form gels by cooling down the temperature of the solution.

Finally, gels can be formed by increasing the concentration of the polymer in such a way that the polymer chains do not have enough space in the solvent to move freely in the solution. In these gels, the polymer chains are entangled together, forming a polymer network in which a liquid phase can be entrapped. Low concentrations of polymers with high molecular weight are required to form gels by this approach compared with polymers of a lower molecular weight. By diluting the gel with a large amount of solvent, the gel structure is lost simply because enough solvent is then available to solubilise the polymer chains.

Polymer gels, and especially polymer hydrogels, show interesting properties for pharmaceutical applications. As already mentioned, polymer gels are mostly composed of a liquid entrapped in the polymer matrix. Thus, some of the properties of a gel are given by the liquid phase it contains.

The other properties are governed by the gelling polymer. For instance, it can be understood that gels obtained from a chemical cross-linked polymer contain permanent covalent bonds. These gels cannot break easily and are permanent. In contrast, gels obtained by other mechanisms are generally reversible gels under certain conditions, except for a few gels. All kinds of gels can be characterised by a swelling ratio defined as the ratio of the weight of the swollen gel to the weight of the dried gel. This ratio defines the capacity of the gel to absorb a liquid phase. The mobility of solute dissolved in the liquid phase depends on its diffusion in the liquid but also on the mesh size of

the matrix formed by the polymer, which can slow down the mobility of the larger molecules due to geometry constraints. This last property makes gels very interesting in the formulation of drug-delivery systems with controlled-release properties. Indeed, gels can be used as a reservoir for a drug, which can move out of the gel matrix when the gel matrix has been placed in contact with receiver media, for instance gastrointestinal fluids or the skin surface. The driving force responsible for the drug release from the gel is the difference in concentration between the inside and the outside of the gel. The release rate of the solute depends on many parameters inherent to the properties of the gel, of the solute itself, and of the interactions of the solute with both the gel and the liquid phase entrapped in the gel. The release rate depends also on the characteristics of the releasing medium.

PHEMA is probably the most widely used hydrogel for biomedical applications. PHEMA can contain about one-third of its weight of water. In addition to the monofunctional monomer, commercial monomers usually contain a small percentage of bifunctional residues resulting from synthesis. Polymerisation leads to a material that is water-insoluble but that can be swollen by an aqueous medium. PHEMA was developed in the 1960s to make hydrophilic soft contact lenses (see Section 4.3.7). PHEMA is also used as a lubricating surface coating for catheters and, due to its capacity to incorporate drugs into its network, is used as a matrix for controlled sustained release of drugs.

As the porous structure of the network can be adjusted, and due to their high water content, hydrogels are first-choice materials to incorporate magnetic resonance imaging (MRI) markers. Colloidal superparamagnetic iron oxide stabilised by binding of dextran chains has been manufactured, e.g. Endorem<sup>®</sup>. Hydrogels containing such an MRI contrast agent have been developed to prepare labelled microparticles for embolisation (see Section 4.3.8).

#### 2.2.4 Polymer dispersions

Another formulation of polymers in liquid media that is of great interest in pharmaceutical applications consists of tiny particles of insoluble polymer dispersed in an aqueous phase. Polymer dispersions are obtained mainly by polymerisation in heterogeneous medium (see Section 3.7.2). In such dispersed systems, polymers are present as spherical particles of diameter less than 1  $\mu\text{m}$ . In general, aqueous dispersions of such polymer particles are characterised by a low viscosity, just above the viscosity of water, even at high concentration, i.e. at several 10% in the dispersed polymer particles. Polymer dispersions in aqueous-based formulations have been developed as coating material to replace the organic solutions of polymers used in the past. Coating operations are facilitated by the coating material being provided in an

aqueous medium and by its having a low viscosity for a high solid content. Gastro-resistant films formed with poly(acrylic) polymers at the surface of tablets or capsules are now obtained from polymer dispersions of the corresponding polymers. Alternative methods require that the polymer is precipitated under small particles in defined conditions. The main difficulty after formation of the polymer particles with the correct size characteristics is to preserve their stability under a dispersed form. This can be achieved by using surfactants or other types of stabilising agent. Finally, in order to be used as coating agents, the polymer particles should display surface properties allowing fusion of particles when they come into contact with each other after they have been sprayed on the surface of tablets or capsules, and after the solvent has been removed during the drying process. Formulations of polymer dispersions for this purpose need to fulfil these crucial requirements in order to be used successfully as a coating material.

Another field of application of polymer dispersions is in the advanced research of drug-delivery systems that aim to design drug carriers that can target the loaded drugs to diseased cells. Dispersed polymer particles of diameter less than  $1\ \mu\text{m}$  were found to be suitable for this. Using polymers compatible with this application, such particles can be obtained by polymerisation in heterogeneous systems (see Section 3.7.2) or by precipitation methods directly from the polymer. These polymer dispersions need to remain stable in media that can be used for *in vivo* administration and to display suitable surface properties to fulfil the drug-delivery duty with the desired pharmacokinetic and biodistribution profiles. A tremendous amount of work has been spent on designing the polymer particle surface to ensure stability of the particles as dispersions and to confer the particles with the desired biopharmaceutical characteristics. It remains a challenging milestone in the battle that aims to increase the specificity of the action of drugs used in the treatment of severe diseases.

Polymer dispersions containing polymer micelles are another system of interest for pharmaceutical applications. These are obtained from amphiphilic polymers that self-aggregate as small spherical entities above a critical concentration of polymer in the solution named the critical micelle concentration (CMC). The main difference between polymer micelles and the particles described above is that the micelle-forming polymer is fully soluble in the dispersing medium below the CMC and itself aggregates to form micelles just by raising the concentration in polymer above the CMC. Micelles are reversible aggregates and can be solubilised by diluting the polymer solution to reach a concentration below the CMC. This is fundamentally different from the previously described particles that form only when applying a more or less sophisticated preparation method and that are not destroyed by simple dilution with an excess of dispersing medium. Micelles are characterised by a well-defined structure; this results from the aggregation of the amphiphilic



copolymers in such a way that the surface energy at the interface between the aggregate and the dispersing medium is minimal. Thus, in aqueous medium, the lipophilic part of the copolymers assembles to form lipophilic compartments surrounded by the hydrophilic part of the copolymers, which ensures the stability of the micelle. Micelles consist of core shell particles of nanometric size in which lipophilic drugs can be solubilised.

## 2.3 Relationships between structure of polymers and cohesion of materials

Many polymers are used as materials. The cohesive properties of polymeric materials result from their structural characteristics and in many cases from the thermomechanical processes used to transform the crude polymer into objects (Box 2.1). The aim of this section is to examine the structural parameters of polymers capable of influencing the cohesive properties of polymeric materials.

### 2.3.1 Influence of molecular weight

In a molecule, the binding energy between atoms does not depend on the molecular weight of the molecule. Typically, energy of a few hundreds of kilojoules has to be spent in order to break one mole of covalent carbon-carbon bonds. However, the energy that has to be spent in order to separate two molecules, i.e. the cohesive energy, strongly depends on the molecular weight of the molecules. The interactions between molecules, due to van der Waals forces, can be broken by supplying a few tens of kilojoules per mole in the case of small molecules. The high molecular weight of polymers results in increasing cohesive properties. The resulting physical properties such as melting and boiling temperatures are also increased, as shown in Table 2.4.

The shortest hydrocarbons, i.e. methane to butane, are gaseous at room temperature. The thermal energy at this temperature is not sufficient to separate larger molecules from each other, which are more cohesive and in the condensed state, either liquid or solid. The cohesive energy between linear

#### **Box 2.1**

The structural characteristics resulting from synthesis provide the possibility of a regular structure. Strong interactions between chains leading to high crystallinity and high mechanical strength are strongly improved by thermomechanical treatments. See, for instance, Table 4.2 for the thermomechanical properties of some biodegradable polymers before and after processing.

**Table 2.4** Increasing molecular weight of linear alkanes results in increasing melting and boiling temperatures

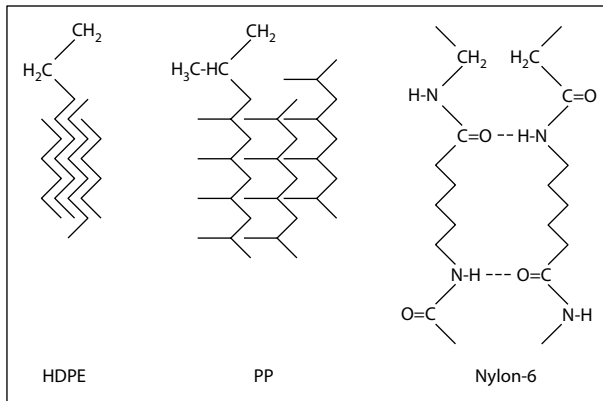
Molecule	CH <sub>4</sub>	C <sub>2</sub> H <sub>6</sub>	C <sub>4</sub> H <sub>10</sub>	C <sub>6</sub> H <sub>14</sub>	C <sub>8</sub> H <sub>18</sub>	C <sub>12</sub> H <sub>26</sub>	C <sub>20</sub> H <sub>42</sub>
Molecular weight (g/mol)	16.04	30.07	58.12	86.18	114.23	170.34	282.54
Melting temperature (°C)	−182	−182	−138	−95	−56.5	−9.6	36.8
Boiling temperature (°C)	−161	−89	−0.5	68	125	216	343
State at room temperature	Gas	Gas	Gas	Liquid	Liquid	Liquid	Solid

hydrocarbon chains tends towards a limit. However, in the case of polymers, the cohesive energy can surpass the energy of the carbon–carbon bond, which can be broken when a sufficient amount of energy is provided to the material in a short time, e.g. during a shock.

### 2.3.2 Influence of crystallinity

Cohesive energy, which depends on molecular weight for all molecules, depends also on the organisation between macromolecular chains. The existence of a long-range order between chains is characterised by crystallinity. In crystalline fusion, a sharp change occurs from an ordered solid state to a more disordered liquid state with rising temperature. The phenomenon is sharp for metals and small organic molecules, but it is usually less sharp for macromolecules. This is due to the fact that polymers are usually not completely crystalline but are composed of crystalline and amorphous domains. However, highly crystalline polymers are endowed with a defined melting temperature ( $T_m$ ) (see Section 2.1.2 for method of determination).

The structure of the polymer resulting from synthesis determines the possibility of the presence of crystalline domains. The possibility of the presence of stereo-regular domains can be found in linear polymers with a regular and compact chain structure. Stacking up of chains is favoured by such structural conditions. This is typically the case for high-density polyethylene (HDPE), which is highly linear, with only hydrogen atoms borne by the backbone, and also for poly(tetrafluoroethylene) (PTFE) as the fluorine atoms are small enough. In the case of low-density polyethylene (LDPE), which bears about one butyl group per 100 methylene units, crystallinity is strongly reduced. Isotactic polypropylene, but not atactic polypropylene, is also endowed with a high stereo-regularity. The possibility of the presence of crystalline domains is still increased by the presence in the chains of polar groups such as carbonyl groups (acceptors) and amino groups (donors), inducing hydrogen bonds between chains, e.g. in polyamides (Nylons) or in polyimides. Some examples are given in Figure 2.13.



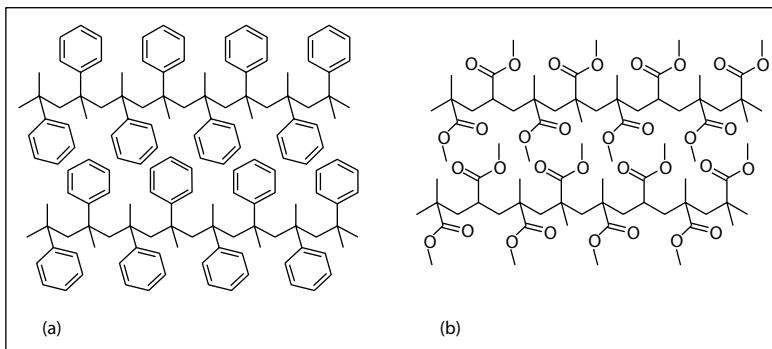
**Figure 2.13** Examples of crystalline polymers: high-density polyethylene (HDPE), isotactic polypropylene (PP) and polyamide-6 (Nylon-6).

The possibility of the presence of crystalline domains is thus linked only to the structure of the polymer, but the percentage of crystallinity in the material can be increased by thermomechanical processing such as hot drawing, which makes possible an optimal alignment of all the chains and stacking up.

### 2.3.3 Glass transition of amorphous domains

Large crystalline domains cannot easily be generated in many polymers that remain mainly amorphous. This can be due to the presence of bulky and/or rigid substituents inducing a steric hindrance, which prevents alignment and stacking of chains. This is typically the case for polystyrene (PS) and poly (methylmethacrylate) (PMMA), shown in Figure 2.14, which are in a rigid and fragile glassy state at room temperature.

With increasing temperature (above  $T_g$ ), such amorphous polymeric materials can become viscous and more flexible and the shape of the material can



**Figure 2.14** Examples of amorphous polymers. The phenyl group on polystyrene (PS) (a) and the ester group on PMMA (b) are too bulky to make possible easy crystallisation of the polymers.

be changed by various processes, e.g. extrusion and moulding. Below  $T_g$  the polymer chains in the material are immobile, while above  $T_g$  the chains can move, explaining why the material properties change. A further decrease of temperature below  $T_g$  regenerates the rigid properties and stabilises the shape of the object. In semi-crystalline polymers, only the amorphous domains are concerned by glass transition. Mechanical properties depend on  $T_g$  compared with the temperature of the surrounding medium.

When  $T_g$  is well above the surrounding temperature, the bulky side groups can hardly move and the polymer is rigid, glassy and fragile. When  $T_g$  is close to the temperature of the surrounding medium, segments of molecules can move and the polymer is viscous. When  $T_g$  is well below the temperature of the surrounding medium, the chains can move and the polymer behaves as an elastomer.

Examples of glass transition temperature of some polymers are given in Table 2.5.

The influence of the side groups is well illustrated in the case of poly(alkylacrylates) and poly(alkylmethacrylates). It is interesting to compare these polymers, since the difference lies only in the presence of a methyl group as a side chain of poly(alkylmethacrylates) instead of simple hydrogen in the poly(alkylacrylates). In the poly(alkylacrylates), the main chains are repelled from each other by the ester side chains. Increasing size of the side chain decreases  $T_g$ . In the poly(alkylmethacrylates), the methyl group hinders the movement of the main chains. For a similar ester side chain,  $T_g$  is markedly increased when compared with corresponding poly(alkylacrylates).

**Table 2.5** Glass transition temperature of some polymers and their properties at room temperature

Polymer	$T_g$ (°C)	At room temperature
Poly(dimethylsiloxane)	-127	Elastomer
Polybutadiene	-85	Elastomer
Polyisoprene 1-4 <i>cis</i> (natural rubber)	-70	Elastomer
Polystyrene	100	Rigid
Poly(methylacrylate)	0	Viscous
Poly(ethylacrylate)	-25	Rather elastic
Poly( <i>n</i> -butylacrylate)	-60	Elastomer
Poly(methylmethacrylate)	85	Rigid
Poly(ethylmethacrylate)	50	Rigid
Poly( <i>n</i> -butylmethacrylate)	20	Rather viscous

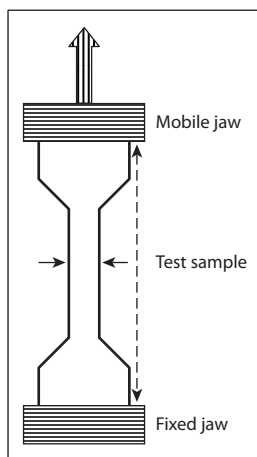
Poly(dimethylsiloxane) (PDMS) is interesting because it possesses the required structural qualities to crystallise. This can be achieved at low temperatures, but the chains are so mobile that PDMS does not remain crystalline at room temperature.

## 2.4 Properties of polymers as materials

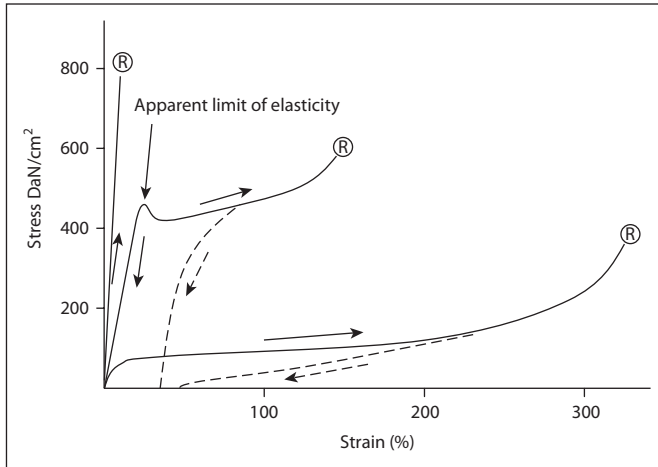
Polymeric materials used in medical devices are selected in order to meet different requirements depending on the specific *in vivo* application. The reactions of living tissues in contact with a material are exquisitely sensitive to the material's surface properties, and so these and the mechanical properties given by the bulk of the material have to be characterised.

### 2.4.1 Some mechanical properties

The mechanical behaviour of polymeric materials is often characterised by their stress/strain properties. A tension stress is applied at a very slow rate to a piece of material, which usually has a standardised dumbbell shape, as illustrated in Figure 2.15. Elongation, i.e. strain, is measured until the sample breaks. The results are usually displayed as a plot of stress versus strain. The stress reported to the smallest section of the sample is expressed in newtons per square centimetre ( $\text{N}/\text{cm}^2$ ). The strain is usually expressed as the percentage of the original length of the sample ( $\Delta L/L \times 100$ ). Some typical stress/strain plots are shown in Figure 2.16.



**Figure 2.15** Measurement of tensile strength (stress/strain) of a sample of material. A force (in newtons, N) is applied to a dumbbell test sample of initial length  $L$  (in cm) and initial section  $S$  (in  $\text{cm}^2$ ). The mobile jaw is moving at a slow speed and the relative strain ( $\Delta L/L \times 100$ ) is measured.

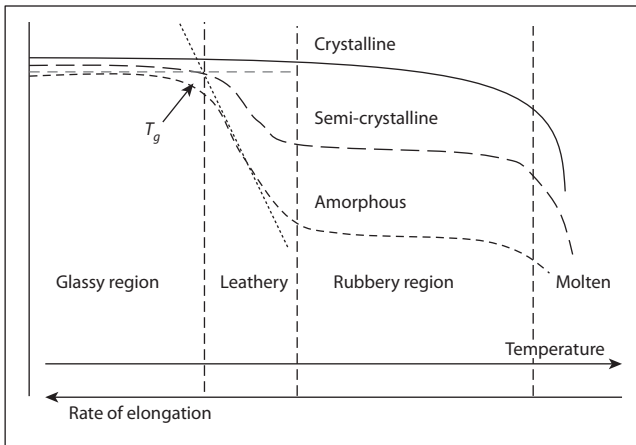


**Figure 2.16** Typical stress/strain graphs. Clockwise: rigid plastic,  $T_g \gg$  room temperature; flexible plastic,  $T_g \cong$  room temperature; elastomer,  $T_g \ll$  room temperature; ® = rupture.

Important information can be drawn from such stress/strain plots:

- The modulus of elasticity is given by the initial slope of stress versus strain. It should be determined at a given temperature in conditions of quasi-reversibility, i.e. at a very low rate of elongation, in order to be as accurate as possible. The modulus is also expressed in  $\text{N}/\text{cm}^2$ .
- Elastic elongation is determined by the extent of reversible elongation. For flexible ‘plastics’, it corresponds only to the first part of the plot.
- Strength and elongation at breaking are sometimes named ultimate strength and elongation. As rupture is initiated at defects of the sample, these data are usually not very accurate.

The mechanical behaviour of polymeric materials depends on several parameters such as degree of crystallinity, melting temperature, glass transition and cross-linking. Typically, elastomers are highly amorphous, with a very low  $T_g$ . Their modulus of elasticity is low and they can undergo a very large elongation. However, elongation may be not completely reversible and a slight degree of cross-linking is generally necessary in order to obtain a completely reversible behaviour. In contrast, the modulus of elasticity of highly crystalline or highly cross-linked polymers, and of polymers with a  $T_g$  well over room temperature, is high; such polymers can undergo only a very small elongation before breaking. Rigid and amorphous polymers such as PS are much more fragile than crystalline polymers such as Nylon fibres. The behaviour of flexible ‘plastics’ is in between, with a rather high initial modulus that depends strongly on the degree of crystallinity, and a domain of irreversible elongation that can be extended. A complete view of the mechanical behaviour of polymers can be



**Figure 2.17** Variation of the initial modulus of elasticity with temperature increase (from left to right) or increasing rate of elongation (from right to left).

represented by the variation of the modulus of elasticity as a function of either temperature or rate of elongation, as shown in Figure 2.17.

Whatever the polymer, when the rate of elongation is very fast or the temperature is very low, the polymer behaves as a rigid and fragile material. With highly crystalline polymers, increasing temperature decreases the modulus only slightly until the melting temperature is reached. With amorphous polymers, a sharp decrease in the modulus is observed in the range of glass transition. The behaviour of semi-crystalline polymers is in between.

Other mechanical properties can be tested, depending on the specific application. Mechanical properties can be strongly affected by implantation in a living tissue, which can be very aggressive for some types of polymeric material that are otherwise usually stable *in vitro*.

## 2.4.2 Surface properties

The biocompatibility of a material strongly depends on its surface properties, as living tissues are in contact with the surface of the material (see Section 4.3.3). The surface composition of a material can be very different from the bulk composition. This is well known for metals, e.g. the surface of titanium and titanium alloys is generally covered with titanium oxide. This can also be true for polymers, depending on the history of the material and even in the absence of contamination (an example of contamination is given in Section 4.3.5).

For instance, PS has been widely used for *in vitro* biomedical applications. Storage boxes, Petri dishes for cell or tissue culture, and latexes for diagnosis purposes are frequently made of PS. However, although the bulk composition of these materials is similar, the surface compositions are different: the surface of storage boxes made of pure PS is hydrophobic, whereas that of Petri dishes and latexes for diagnosis purposes is more hydrophilic. Pure PS is not suitable

for cell or tissue culture, as cells do not spread on it and cannot survive; Petri dishes are therefore submitted to surface treatments, for instance by glow discharge (i.e. an electrical cold gas plasma), in order to modify the surface chemistry and make the attachment and survival of cells possible. Latexes for diagnosis purposes are prepared by emulsion polymerisation in aqueous phase (see Section 3.7.2). As the initiator of polymerisation is generally a peroxodisulphate, the surface of the resulting latex is covered by covalently linked sulphate groups, which are highly hydrophilic, bear negative charges and are able to stabilise the latex.

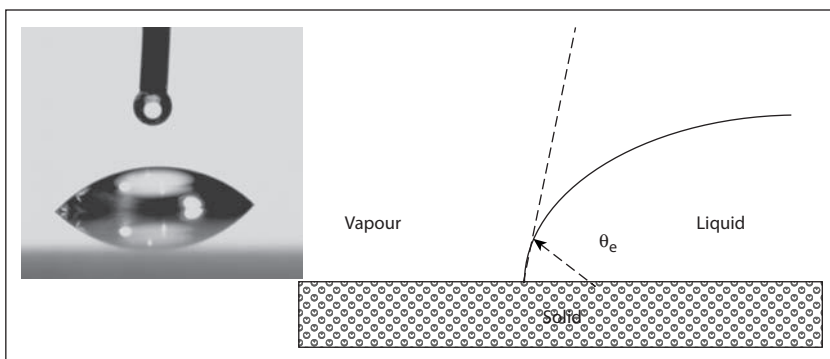
It can be seen from these examples that cells and tissues are very sensitive to the composition of the materials surface. Several physicochemical techniques for analysing the composition of materials surface have been described. However, attention is drawn to the fact that the surface analysed by most of these methods is not the surface 'analysed' by living cells, as cells recognise only the outermost layer of a hydrated material. Analysing this ultimate hydrated layer by a physicochemical method is a real challenge. Indeed, the most surface-sensitive methods such as electron spectroscopy for chemical analysis (ESCA; also known as X-ray photoelectron spectroscopy, XPS) and secondary-ion mass spectrometry (SIMS) can analyse respectively a few layers at once or one layer after the other, but in strictly dry conditions. Performing an ESCA analysis at a very low temperature in order to keep water frozen has been described, but this is currently far from a routine method. Conversely, analysis of hydrated surfaces by ATR-IR is usual, but this method determines the composition of many layers in addition to the ultimate layer, as it analyses a depth of more than 1  $\mu\text{m}$ .

Because of the restrictive possibilities of relevant physicochemical surface analysis, different strategies can be adopted. For instance, the effects of surface composition on cells or tissues can be tested on completely modified model materials in which the surface and the bulk are similar. The relevant modification can then be achieved only on the surface.

A simple experimental evidence of surface modification, for instance concerning the hydrophilic/hydrophobic balance of the surface, can be searched for. To do this, the simplest and oldest method measures the contact angle at 'equilibrium' between the clean surface of a material, a liquid and its vapour. This method permits evaluation of the surface tension of material surfaces, which can be related to the hydrophilic/hydrophobic balance. Several experimental processes have been described, but the simplest is deposition of a droplet of liquid on the surface, as shown in Figure 2.18.

The surface tension is calculated by using the Young–Dupré equation (Equation 2.10). In this equation,  $\gamma_{LV}$  is the surface tension between the liquid and its vapour, and  $\theta_c$  is the solid/liquid contact angle measured at 'equilibrium'. The critical surface tension, which is characteristic of a material surface, corresponds to  $\theta_c = 0$  (or  $\cos \theta_c = 1$ ). As zero angles cannot be





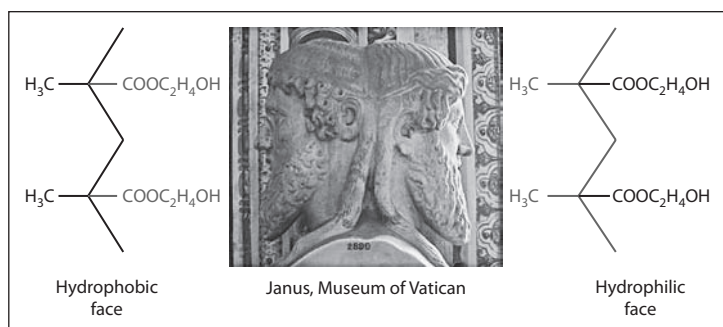
**Figure 2.18** Measuring the contact angle at 'equilibrium'. A droplet of liquid is deposited on the horizontal clean surface of the material. The size of the droplet should be small enough to decrease the effects of gravity. When apparent equilibrium has been reached, the contact angle is measured.

measured, the critical surface tension can be assessed by extrapolation after measuring the contact angles between the material surface and several liquids of different  $\gamma_{LV}$ . The surface tension is expressed in energy unit per surface unit. As this equation is rather old, surface tensions are still expressed in some tables as dyne/cm ( $\text{erg/cm}^2$ ), corresponding to  $\text{mN/m}$  ( $\text{mJ/m}^2$ ) in SI units. The critical surface tension of some polymeric surfaces is given in Table 2.6.

$$\gamma = \gamma_{LV} \cdot \cos \theta_e \quad (2.10)$$

**Table 2.6** Critical surface tension of some polymers

Polymeric material	Abbreviation	Tension ( $\text{mJ/m}^2$ )
Polytetrafluoroethylene	PTFE	19
Poly(dimethylsiloxane)	PDMS	24
Poly(vinylidene fluoride)	PVDF	25
Polyethylene	PE	31
Polystyrene	PS	33
Poly(2-hydroxyethylmethacrylate)	PHEMA	37
Poly(methylmethacrylate)	PMMA	39
Poly(vinyl chloride)	PVC	39
Poly( $\epsilon$ -caprolactame) (Nylon-6)	PA-6	42
Poly(ethylene terephthalate)	PET	43
Polyacrylonitrile	PAN	50



**Figure 2.19** Like Janus, poly(2-hydroxyethylmethacrylate) (PHEMA) has two faces. The face presenting the carbon–carbon chain and methyl groups is hydrophobic. The face presenting the hydroxyethyl esters is hydrophilic.

These values found in several reference books require a comment. Concerning ‘simple’ polymers such as PTFE, polyethylene (PE) and PS, the given values are a direct reflection of their hydrophobicity and even lipophobicity for PTFE. For PHEMA, the value of the critical surface tension is questionable as this polymer is well known as the main constituent of hydrophilic soft contact lenses. This can be explained by the fact that PHEMA has two faces, one hydrophobic, the other hydrophilic, like the Roman god Janus shown in Figure 2.19.

When PHEMA is prepared, it is surrounded by a hydrophobic medium and the polymer is hydrophobic. When the medium surrounding PHEMA is replaced by a hydrophilic medium, the polymer is able to become hydrophilic. However, since dry PHEMA is rigid at room temperature, changing from the hydrophobic material to the hydrated material takes a long time. Thus, it can be assumed that the conditions in which the critical surface tension of PHEMA was measured were not at true thermodynamic equilibrium. This was clearly demonstrated by determining the advancing and receding contact angles on a partially immersed plate.

## Bibliography

### Determination of molecular weight of polymers, MALDI-TOF and determination of copolymer composition

- Ibbeth NR, ed. (1993). *NMR Spectroscopy of Polymers*. London: Blackie Academic & Professional.
- Koenig JL, ed. (1999). *Spectroscopy of Polymers*. Amsterdam, New York: Elsevier.
- Pasch H, Schrepp W, eds (2003). *MALDI-TOF Mass Spectrometry of Synthetic Polymers*. Berlin, New York: Springer.

## Gels and hydrogels

Steinbüchel A, Marchessault RH, eds (2005). *Biopolymers for Medical and Pharmaceutical Applications. Vol. 1: Humic Substances, Polyisoprenoids, Polyesters and Polysaccharides*. Weinheim: Wiley-VCH.

## Polymer dispersions

Carraher CE, ed. (2003). *Polymer Chemistry*, 6th edn. New York: Marcel Dekker.  
Ebewele RE, ed. (2000). *Polymer Science and Technology*. Boca Raton, FL: CRC Press.

## Mechanical properties

Barton AFM, ed. (1983). *Handbook of Solubility Parameters and other Cohesion Parameters*. Boca Raton, FL: CRC Press.  
Ferry JD (1980). *Viscoelastic Properties of Polymers*, 3rd edn. New York: John Wiley & Sons.

## Surface properties

Andrade JD, ed. (1985). *Surface and Interfacial Aspects of Biomedical Polymers. Vol. 1: Surface Chemistry and Physics; and Vol. 2: Protein Adsorption*. New York: Plenum Press.  
Ratner BD, ed. (1988). *Surface Characterization of Biomaterials*. Amsterdam: Elsevier.  
Stuart B, ed. (2002). *Polymer Analysis*. Chichester: John Wiley & Sons.

# 3

## Main methods and processes to synthesise polymers

---

3.1 Why there is a need to synthesise polymers	55	3.5 Limitations of polymerisation	64
3.2 Introducing step and chain polymerisations	56	3.6 Overview of other synthetic methods	66
3.3 Some examples of step polymerisation: from small reagents and from prepolymers	58	3.7 Polymerisation reaction processes	73
3.4 Free radical chain polymerisation	59	3.8 Copolymerisation	80
		3.9 Modifications of polymers	81
		Bibliography	85

---

### 3.1 Why there is a need to synthesise polymers

It was shown in Chapter 1 that life is supported by many natural polymers or macromolecules. Natural polymers have been used for centuries, e.g. natural rubber. Modification of natural polymers permitted new useful goods to be made, but sometimes not very well adapted to everyday life, e.g. the highly flammable celluloid.

The domain of health provides remarkable illustrations of the necessity to create new polymers. Natural materials have been used for centuries to replace missing parts of the body: parietal plates made of gold or silver have been found in mummies; silk and ‘catgut’ sutures have been used for many years by surgeons; and cellulose and derivatives are still used as excipients in formulations of drugs designed to be administered by the oral route. However, such materials were not always adequate and their properties were not always reproducible. Some adverse reactions have occurred, leading to failure of the material, for reasons unknown at the time. Box 3.1 describes some examples of the problems associated with ‘technical-grade’ polymers.

**Box 3.1** *Examples of drawbacks encountered when using technical-grade polymers*

For storage of blood, single-use plasticised poly(vinyl chloride) (PVC) bags replaced heavy, breakable glass flasks. However, migration of the plasticiser di-(2-ethylhexyl) phthalate (DEHP) into blood has been observed. Plasticised PVC is still used but is restricted to short-time contact as single-use tubing.

For the joints of hip prostheses, poly(tetrafluoroethylene) (PTFE, e.g. Teflon<sup>®</sup>) was tested for its well-known low-friction properties. However, this material does not resist wear under compression, leading to failure of the prosthesis.

For the main piece of hip prostheses, the use of carbon-fibre-based composites was suggested because of their lightness and excellent mechanical properties. However, debris of carbon fibres was found in the surrounding tissues, leading to the withdrawal of such types of composite for use in living tissues.

In the 1980s, the need to create materials designed for use in the body gave the impetus to biomaterials. In pharmacy, sustained controlled-release systems and later targeted drug-delivery systems led to the development of hydrogels, biodegradable polymers and nanomaterials.

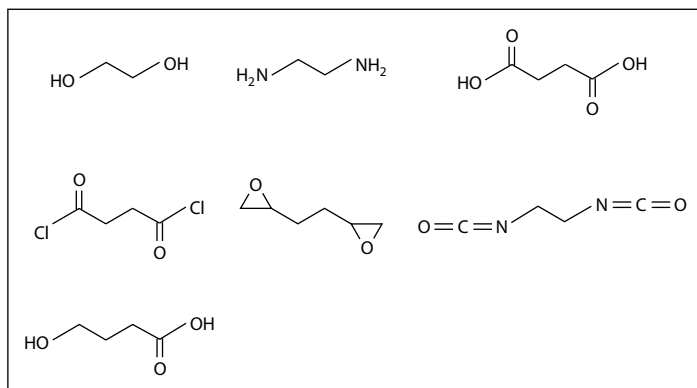
In order to understand how synthetic polymers are prepared, the methods and processes of polymerisation are presented in this chapter and Chapter 4. It can be seen that some properties of polymers, especially surface properties, depend on the synthesis. The classical techniques are introduced first, but the more specific techniques needed to synthesise special polymers are emphasised.

### 3.2 Introducing step and chain polymerisation

Two mechanisms of polymerisation have been described: step polymerisation and chain polymerisation. The monomers that are used are completely different. Monomers used in step polymerisation bear at least two chemically reactive groups per molecule (e.g. alcohol, amine, epoxy, carboxylic acid or chloride, isocyanate). The groups may be similar (e.g. diols) or different (e.g. acid and alcohol), as shown in Figure 3.1.

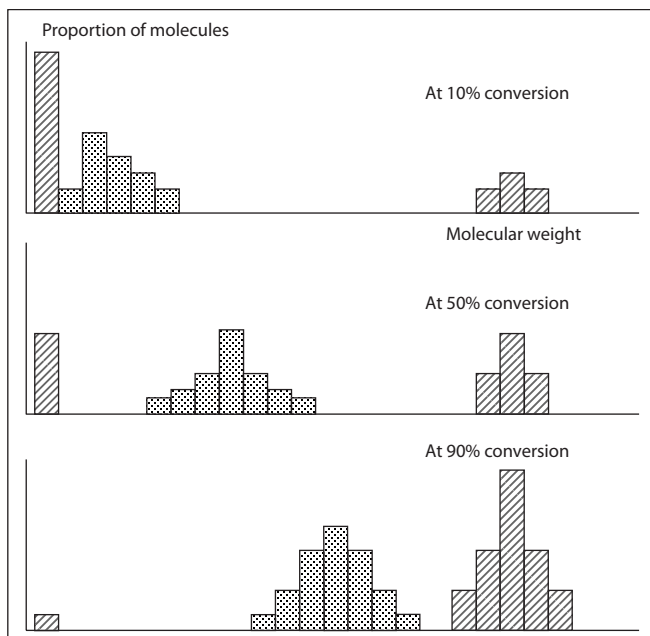
The mechanisms that are implied and the composition of the reaction media versus time are completely different in step and chain polymerisation, as shown in Figure 3.2.

At each step of step polymerisation, two groups react together, e.g. alcohol and acid, whatever the length of the molecule bearing the groups. As the



**Figure 3.1** Some bifunctional monomers used in step polymerisation: diol, diamine, dicarboxylic acid, dicarboxylic acid chloride, diepoxide, diisocyanate, hydroxyacid.

reaction proceeds, elongation of the chains can occur either by reaction of oligomers with other oligomeric chains or by reaction of oligomers with remaining monomers. The molar fraction of monomers in the reactive medium decreases very rapidly, leading to fast formation of oligomers at the beginning of polymerisation. Thus, the reaction medium is composed of molecules of



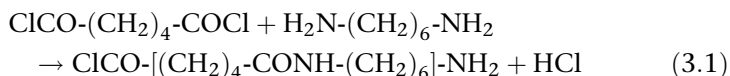
**Figure 3.2** Composition of reaction medium as a function of conversion. In chain polymerisation (hatched), the reaction medium contains monomers and high-molecular-weight polymer even at low conversion. Increasing conversion increases yield in polymer, not molecular weight. In step polymerisation (dotted), the reaction medium contains monomers and oligomers at low conversion. Increasing conversion increases polymer molecular weight.

slowly increasing length. Concentration of reactive groups decreases with increasing time and a long time is required to obtain high-molecular-weight polymers, at least when using small molecules as monomers.

Monomers used in chain polymerisation contain one or two double bonds, or a triple bond or a cycle. Following generation of an active site able to open the bonds or cycles, the chain grows by successive and fast additions of monomers. The molar fraction of monomers in the reactive medium decreases rather slowly, leading to formation of long polymeric chains. Thus, the reaction medium is composed of a mixture of monomer and high polymer, even at low conversion. The active sites usually have a short life and their concentration is low and almost constant with time. Increasing the reaction time increases the conversion yield of monomer into polymers but not the average chain length of the polymers.

### 3.3 Some examples of step polymerisation: from small reagents and from prepolymers

The first industrial success in step polymerisation was the synthesis and development by Carothers and co-workers at DuPont of the famous polyamide Nylon 6-6, starting from hexamethylene diamine and adipic acid dichloride. As shown in Equation 3.1, this reaction is favoured by elimination of hydrochloric acid.



The number average degree of polymerisation ( $DP_n$ ) can be calculated as a function of functionality of the monomers, i.e. the number of reactive groups per monomer, and as a function of the extent of conversion. For a functionality of 2.000, i.e. corresponding to very pure difunctional monomers, and for 99.9% conversion, it can be calculated that  $DP_n = 1000$ , i.e. a number-average molecular weight of about 200 000.

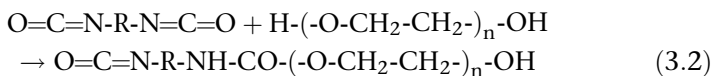
The following conditions are required in order to obtain high-molecular-weight linear Nylon 6-6:

- highly purified monomers, as the presence of monofunctional impurities stops the chain growing and the presence of trifunctional impurities leads to branched polymers
- good control of stoichiometry
- long reaction time.

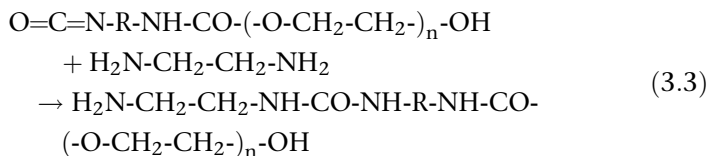
Thus, such a synthesis is expensive and Nylon 6-6 has now been replaced by Nylon 6 produced by ring-opening polymerisation (see Section 3.6).

Some high-molecular-weight polymers can be obtained by using reagents that are already small polymers, called prepolymers. This is the case for polyurethanes and poly(urethanurea)s. For instance, a poly(ether urethane)

can be obtained by reacting a poly(ethylene glycol) (PEG), which has two OH end groups, with a diisocyanate such as methylene bis-4-phenyl isocyanate, as shown in Equation 3.2. In this example, R = methylene bis-4-phenyl.



Addition of a diamine such as ethylene diamine leads to a poly(ether urethane urea), as shown in Equation 3.3.



Such poly(ether urethane urea)s are well known as Lycra<sup>®</sup> and Spandex<sup>®</sup> in the textile industry and as Biomer<sup>®</sup> and Pellethane<sup>®</sup> in the biomedical field.

### 3.4 Free radical chain polymerisation

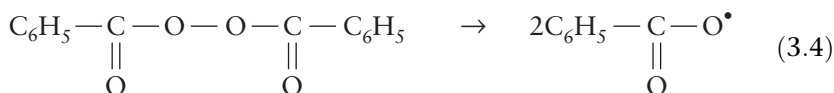
Free radical chain polymerisation is the method used to prepare the most common polymers. A free radical is generated and reacts with one molecule of monomer (initiation). Then monomer molecules react with this first species, leading to formation of a long chain by successive additions of monomer (propagation). Finally, chains are terminated by reaction of two chains bearing radicals (termination). As radicals are very reactive species, side reactions are likely to occur and modify the simple process (transfer).

#### 3.4.1 Initiation: generation of radicals

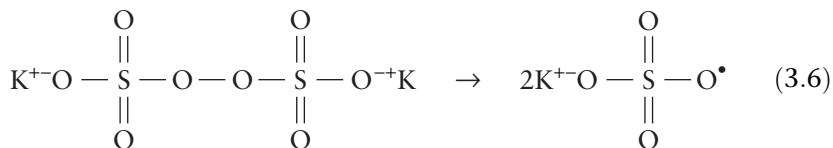
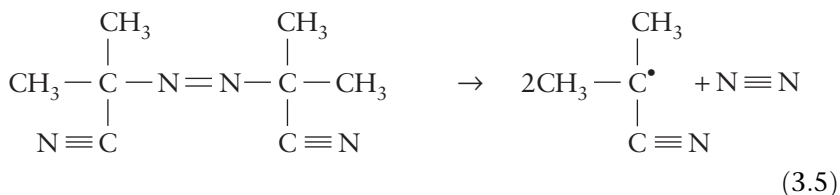
Chain polymerisation can be initiated by free radicals generated through different mechanisms. Free radicals are generally very unstable and reactive species; thus, they can easily react with the  $\pi$  electrons of carbon=carbon double bonds, leading to the bonds opening and starting chain polymerisation.

##### *Chemical initiation by thermal decomposition of fragile bonds*

The most common process used to generate free radicals is the homolytic thermal decomposition of a molecule containing a fragile symmetrical bond, such as peroxides (R-O-O-R), hydroperoxides (R-O-O-H), azonitriles (R-N=N-R) or peroxodisulphates (see Equations 3.4–3.6).





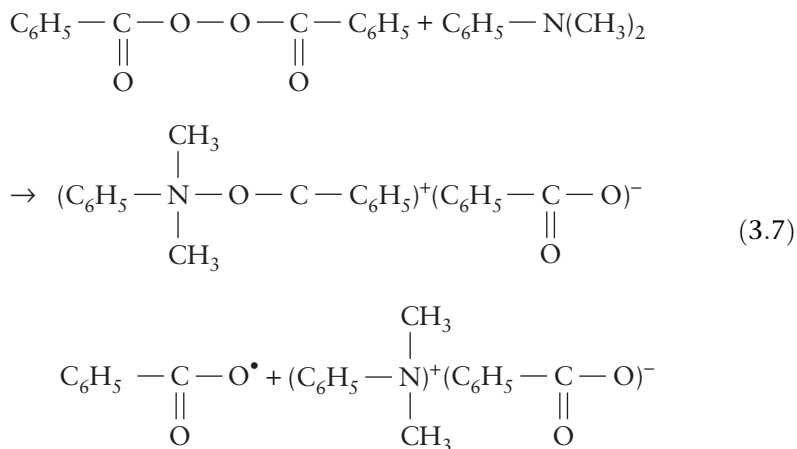


Benzoyl peroxide (BPO) and 2,2'-azo-bis-isobutyronitrile (AIBN) are soluble in organic medium, whereas peroxodisulphates are water-soluble. The rate of decomposition is significant for AIBN over 60 °C and for peroxides over 80 °C.

### Redox initiation

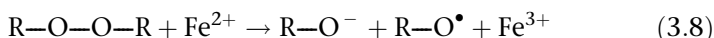
#### Redox catalysis of peroxide decomposition

To permit the generation of radicals at a sufficient rate, the temperature used in industrial processes ranges between 60 °C and 150 °C, depending mainly on the type of initiator used. Addition of reductants as catalysts of peroxide decomposition can increase the rate of radical generation, allowing the use of such initiators at lower temperatures. An example of catalysis by dimethyltoluidine is given in Equation 3.7.



The rate constant ( $k_d$ ) for decomposition of BPO alone at 90 °C is  $k_d = 1.3 \times 10^{-4}/\text{s}$ . In the presence of dimethyltoluidine the rate constant becomes  $k_d = 2.3 \times 10^{-3} \text{ l/mol.s}$  at 30 °C. Such a catalysed system is used to initiate polymerisation of methyl methacrylate for sealing hip or knee prostheses in vivo, as described in Section 4.3.4.

Ferrous ions can also promote peroxide decomposition, as shown in Equation 3.8; thus, peroxides should not be kept in containers made from iron.



### Organic–inorganic redox pairs

Different inorganic oxidants can react with organic molecules to generate radicals. An example of the reaction between cerium (IV) ions and an alcohol is given in Equation 3.9. Such a reaction has been used to initiate polymerisation of monomers on polysaccharides to obtain mainly graft copolymers and sometimes block copolymers (see Section 3.8).



### Thermal initiation and storage of monomers

**WARNING!** To avoid uncontrolled polymerisation, monomers should be stored in small quantities, at a low temperature, in a dark non-reflecting flask (glass, not metal) and in the presence of 0.1–1% of polymerisation inhibitors.

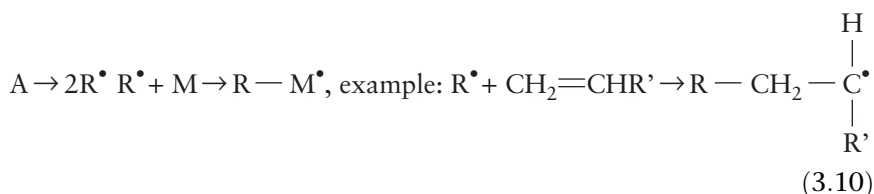
Spontaneous polymerisation of some monomers such as styrene can occur in the presence of sunlight and heat, conditions in which free radicals may be generated. Such an uncontrolled initiation is a dangerous hazard. As polymerisation is an exothermic process, temperature increases in the bulk of the monomer and the process can lead to a blast.

### Photochemical and radiochemical initiations

High-energy radiation such as ultraviolet (UV) radiation, X-rays,  $\gamma$  rays and electron beams can initiate polymerisation. Radicals formed into polymeric materials during sterilisation by such radiation have a long life, especially in the bulk of the material, and can initiate new polymerisation. Such an initiation process has been used widely to modify polymeric surfaces by grafting another polymer.

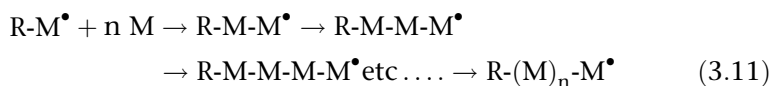
## 3.4.2 Reaction with monomer: propagation and termination

After its generation, the primary radical can react with a monomer molecule (M), as shown in Equation 3.10.



In the propagation phase, monomer molecules react successively and very quickly on the radical centre (Equation 3.11). The rate of each elementary

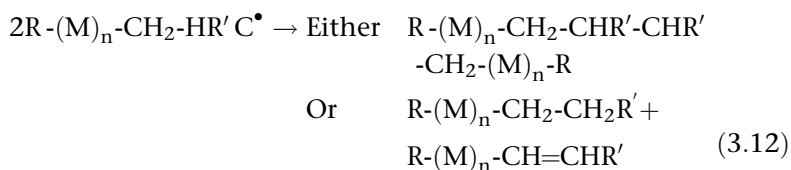
addition is approximately constant.



The average length of the chains can be evaluated before termination:

- If the initial concentration of initiator is constant, then doubling the initial concentration of monomer doubles the average chain length.
- If the initial concentration of monomer is constant, then multiplying the initial concentration of initiator by four halves the average chain length.

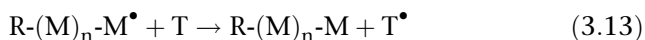
The final chain length depends on the mechanism of termination. In the termination phase, free radicals react in pairs and chain growth is stopped. Depending on the monomers and the conditions of the reaction, two termination processes can occur, as shown in Equation 3.12.



The type of termination is influenced mainly by the steric hindrance of the groups present on the active site.

### 3.4.3 Transfers

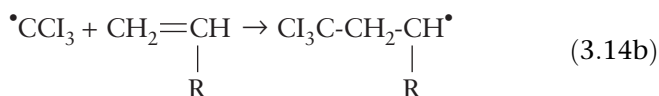
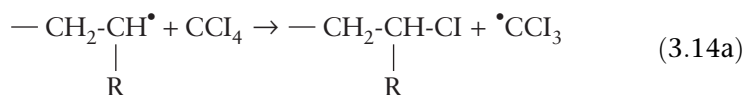
As free radicals are highly reactive, many side reactions can occur. As the radical is transferred from the end of the growing chain to another place or molecule, such reactions are named transfer reactions. The transfer agent T (monomer, solvent, initiator, inhibitor or polymer) reacts with the radical. The initial chain growth is stopped. Depending on the type of the newly formed radical, either a new chain is initiated and starts to grow, or the radical is inactivated, as shown in Equation 3.13.



Examples of transfers include the following:

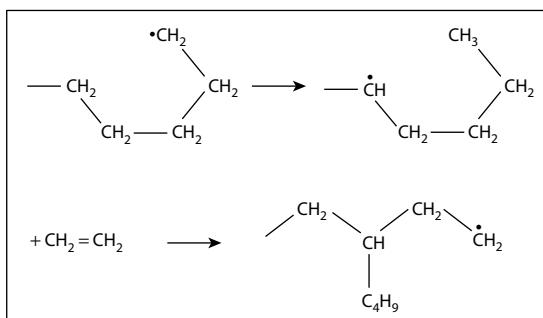
- **Transfer to chlorinated solvents (Equation 3.14):** Chlorinated solvents are very efficient radical transfer agents. As one initial radical leads to two chains, the resulting chains are shorter than in the absence of transfer. This kind of transfer reaction can be used to control the molecular weight of polymers, or to introduce reactive groups (in this case, chlorine) at one end

of the chain.

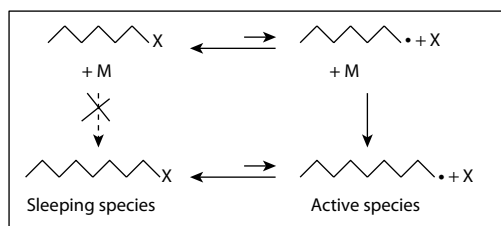


- **Transfer to polymer – example of ‘backbiting’, leading to low-density polyethylene (LDPE) (Figure 3.3):** At the temperature used for the reaction, the polyethylene chain is very flexible and can fold easily. By ‘backbiting’, the radical borne by the chain end is transferred on the fourth carbon before the chain end, and the chain grows on this new location. Such a transfer results in the generation of a branched polymer with about one butyl group for every 100 methylene units. As a result, the long-range order is decreased in the material, i.e. crystallinity is decreased, resulting in lower compacity and density (LDPE) compared with completely linear, highly crystalline polyethylene (HDPE), which is produced by another method (see Section 3.6.3).
- **Transfer to inhibitor:** Inhibitors are transfer agents able to react with radicals, generating new radicals, but these new radicals are too stable to initiate polymerisation and thus polymerisation is stopped. Quinones are an important class of inhibitors frequently used for the storage of monomers in order to inhibit ‘spontaneous’ initiation of polymerisation.

The action of oxygen is rather anomalous, as it can act as an initiator but also as an inhibitor. For this reason, the medium of polymerisation is usually degassed and polymerisation performed under an inert atmosphere, e.g. nitrogen or ideally argon. Oxidants such as  $\text{FeCl}_3$  and  $\text{CuCl}_2$  are strong inhibitors.



**Figure 3.3** Transfer to polymer chain by 'backbiting', leading to low-density polyethylene (LDPE).



**Figure 3.4** Equilibrium between 'sleeping' and active species in controlled radical polymerisation.

### 3.4.4 Controlled radical chain polymerisation

In a classical free radical chain polymerisation, the slowest step is usually the initiation, for instance in the case of thermal decomposition of a peroxide. In the reaction medium, new radicals are continuously generated, initiating new chains. Growth and termination of chains are very fast, and the active centres are rapidly inactivated, as the termination rate is proportional to the square of radical concentration ( $R_t = k_t[M^\bullet]^2$ ). Such a reaction is not controlled, resulting in a large distribution of molecular weight of polymers synthesised by classical free radical chain polymerisation.

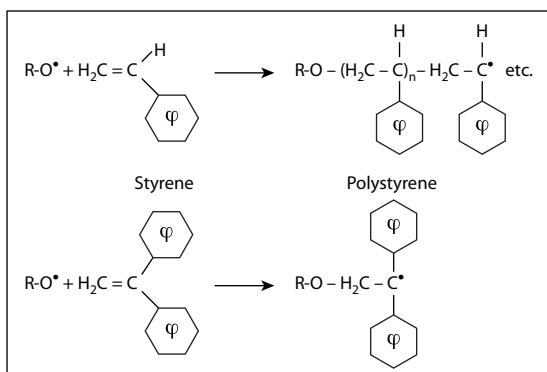
New methods have been developed to control the termination phase in radical polymerisation and to yield polymers with a narrower distribution of molecular weight. Some compounds, such as nitroxides (used in nitroxide-mediated stable free radicals, NSFR), thiocarbonylthio derivatives (used in reversible addition fragmentation transfer, RAFT) and organometallic complexes (used in atom transfer radical polymerisation, ATRP), when added to the reaction medium, make equilibrium possible between a very low concentration of active centres and a higher concentration of 'sleeping' species, as shown in Figure 3.4. Termination reactions are limited, allowing control of radical polymerisation and the generation of types of polymer that could not be obtained by classical radical polymerisation. These methods are currently in active phases of industrial development.

## 3.5 Limitations of polymerisation

Active centres can be generated on many potential monomers, but propagation can be limited by several factors:

### 3.5.1 Limitation by steric hindrance

Propagation can be limited by steric hindrance. An example is given by styrene and related derivatives, as shown in Figure 3.5. Polymerisation of styrene, i.e. phenylethylene, is easy; polymerisation of  $\alpha$ -methylstyrene, i.e. 1,1-methylphenylethylene, is a little more difficult; polymerisation of 1,1-diphenylethylene is impossible. This is due to the fact that the possibility



**Figure 3.5** Limitation by steric hindrance of polymerisation of some styrene derivatives.

of an efficient collision between the radical and a molecule of monomer is very limited by the presence of two bulky phenyl groups on the same carbon.

### 3.5.2 Limitation of radical polymerisation by polarity of bonds

The possibility of free radical polymerisation is linked to homolytic opening of bonds to generate radicals. Such an opening can occur only between atoms of similar or very close electronegativity. Although the polarity of a carbon-carbon bond can be modulated by substituents, homolytic opening is often possible in the case of C=C double bonds. This is never possible for C=O double bonds or for C-O single bonds, which are highly polarised and can be opened only according to an ionic mechanism leading to formation of  $^+C-O^-$ . Possibilities of polymerisation of some monomers through free radical or ionic polymerisations are shown in Table 3.1.

**Table 3.1** Influence of bond polarity on the possible types of initiation

Type of monomer	Type of bond	Type of initiation		
		Radical	Anionic	Cationic
Styrene	C=C	+	+	+
Vinyl chloride	C=C	+	-	-
Vinyl ester	C=C	+	-	-
Vinyl ether	C=C	-	-	+
<i>N</i> -vinylpyrrolidone	C=C	+	-	+
Acrylate or methacrylate	C=C	+	+	-
Aldehyde	C=O	-	+	+
Ethylene oxide	C-O in cycle	-	+	+

### 3.5.3 Thermodynamic limitation and possibility of depolymerisation

A release of heat ( $\Delta H < 0$ ) and a decrease of disorder ( $\Delta S < 0$ ) are associated with polymerisation, i.e. transformation from free monomer to repeating unit in polymer, as shown in Equation 3.15.



The possibility of a transformation is associated with a decrease of free enthalpy ( $\Delta G < 0$ ), and equilibrium between a transformation and the reverse transformation is associated with  $\Delta G = 0$ .

$$G = H - TS, \text{ and so } dG = dH - d(TS) = dH - TdS - SdT.$$

If a transformation is performed in conditions in which the temperature and pressure are constant, then  $SdT = 0$ , and  $\Delta G = \Delta H - T\Delta S$ .

At the temperature for which  $\Delta G = 0$ , polymerisation is in equilibrium with depolymerisation. Because this equilibrium generally occurs in conditions above room temperature, this temperature is called the ceiling temperature ( $T_c$ ). If the temperature of the polymer is below  $T_c$ , then the thermodynamically stable species is the polymer. Conversely, if the temperature of the polymer increases above  $T_c$ , then the monomer becomes the most stable species, i.e. depolymerisation is possible. However, depolymerisation can occur only in the presence of active species, e.g. radicals.

#### *Examples of styrene and $\alpha$ -methylstyrene*

Polymerisation of styrene is associated with  $\Delta H = -67.3$  kJ/mol and  $\Delta S = -10.5$  J/mol.K. Calculation leads to  $T_c = 641$  K, i.e.  $368$  °C. This means that polystyrene is thermodynamically stable below this temperature and can be heated to be transformed into objects, e.g. by moulding, above its glass transition temperature ( $T_g$ ), located around  $100$  °C. However, polystyrene objects are not stable in a fire, resulting in depolymerisation, emission of gases and quick burning.

Polymerisation of  $\alpha$ -methylstyrene is associated with  $\Delta H = -37.6$  kJ/mol and  $\Delta S = -10.9$  J/mol.K. Calculation leads to  $T_c = 345$  K, i.e.  $72$  °C. This means that poly( $\alpha$ -methylstyrene) is thermodynamically unstable above this temperature and cannot be heated safely above its glass transition temperature to be transformed into objects.

Modification of polymers with large substituents, e.g. drugs, can change the ceiling temperature.

## 3.6 Overview of other synthetic methods

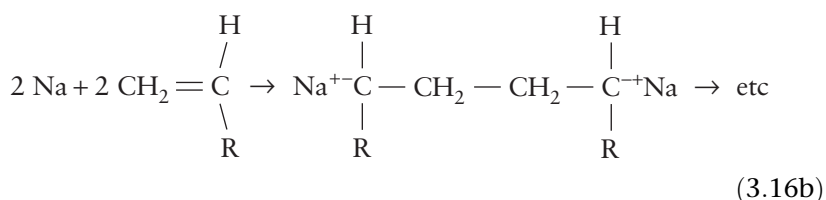
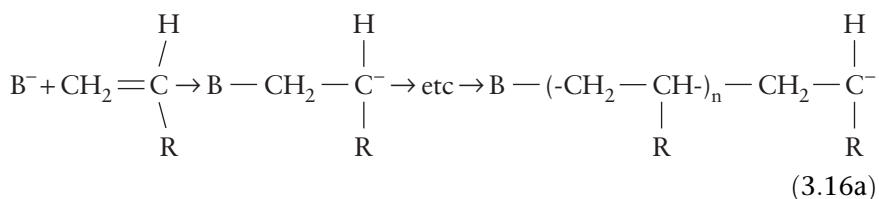
It was shown previously that polarisation of some double bonds prevents polymerisation by a free radical mechanism of molecules containing such bonds. Conversely, double bonds that can be opened by ionic mechanisms

make ionic chain polymerisation possible in the presence of adequate initiators. Some polymers, especially most biodegradable polymers, can be obtained only through such mechanisms. Characteristics of ionic chain polymerisations depend on the reactivities of the monomer and initiator and on the solvent that is usually present in the reaction medium. In polar solvents, e.g. water, alcohols, ethers and chlorinated solvents, the reactive species are solvated ion pairs in equilibrium with solvated free ions. Depending on the polarity of the medium, the concentration of solvated free ions can vary widely, but ions are much more reactive than ion pairs. In apolar solvents, e.g. hydrocarbons, reactive species are weakly dissociated solvated ion pairs and thus are weakly reactive. Consequently, rates of polymerisation are faster in polar solvents than in apolar solvents. Some chelating agents capable of increasing the dissociation of ion pairs can be added to increase the polymerisation rate in such solvents.

### 3.6.1 Anionic chain polymerisation

#### *Polymers prepared by opening of double carbon=carbon bonds*

The first anionic polymerisations were performed in the 1930s by Ziegler in Germany, in order to prepare synthetic rubber. The so-called BuNa was prepared by polymerisation of butadiene initiated by metallic sodium. The detailed mechanisms of anionic polymerisation were described in the 1950s by Szwarc. The common feature of anionic chain polymerisations is the fact that at least one anionic group stabilised by a small cation is located at one end of the growing chains. The initiating species are bases according to the definitions of either Brønsted or Lewis, for instance  $\text{HO}^-$  in water,  $\text{CH}_3\text{O}^-$  in methanol,  $\text{R}_3\text{N}$ ,  $\text{H}_2\text{N}^-$ , organometallic compounds such as derivatives of lithium, magnesium, tin and zinc. The mechanism comprises nucleophilic attack and transfer of the electrons at the end of the chain, as shown in Equation 3.16.

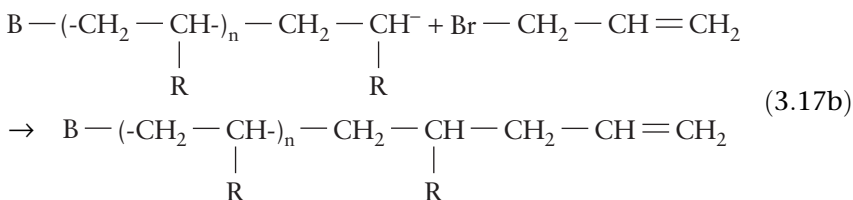
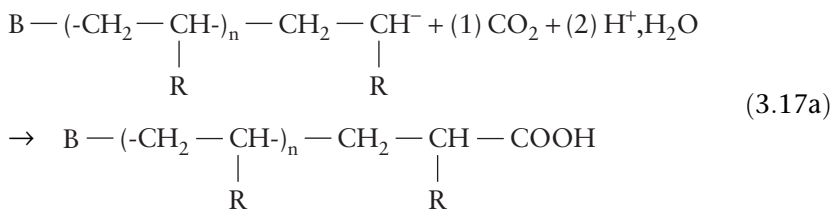




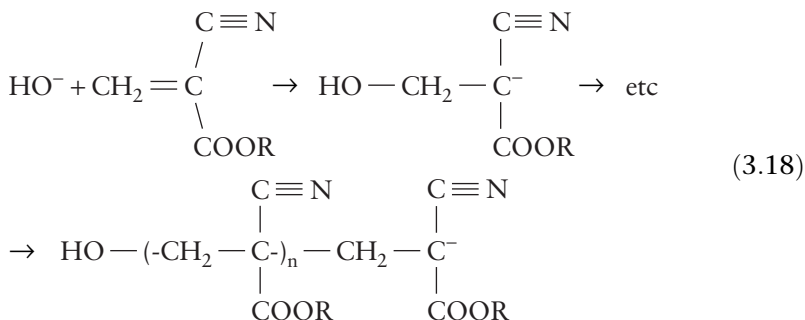
Reactivity in anionic chain polymerisation of monomers possessing a double carbon=carbon bond is increased by the presence of electro-attractive groups on one of these carbon atoms. Depending on the reactivity of the monomer and on the solvent used, different types of initiator can be used.

The propagation rate depends mainly on dissociation of ion pairs and thus on the polarity of the reaction medium. If the rate of initiation is faster than the rate of propagation, then all the chains are initiated at the same time and grow at a similar rate. In this case, polymeric chains can possess a similar length, i.e. polymolecularity is low ( $M_w \cong M_n$ ).

Depending on the reaction medium, termination can be rather slow, and the active site located at the end of the chain can remain active for a few minutes when all of the monomer has been transformed into polymer; for this reason, 'living polymers' can be described. This phenomenon can be taken advantage of when preparing block copolymers (see Section 4.1) or for terminating the chains with groups that can be activated in a further step (telechelic polymers). Examples of telechelic polymers are given in Equation 3.17.



Some monomers, such as alkylcyanoacrylates in which the double bond is highly polarised by the presence of two electro-attractive groups on the same carbon, are very reactive and their polymerisation can be initiated at room temperature by  $\text{HO}^-$  in water, according to Equation 3.18.



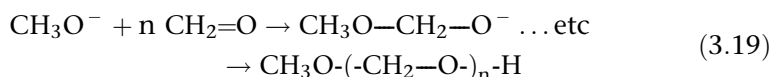
Propagation is very fast and termination is due to hydrated protons. The length and number of chains are highly dependent on the pH of the aqueous medium. This fast polymerisation of the shortest esters initiated in the presence of water vapour is used for obtaining quasi-instant gluing (e.g. Loctite®). Increasing the length of the esters decreases the polymerisation rate. Butyl and higher esters are major components of surgical glues and liquid agents for therapeutic embolisation, and they have also been used to prepare nanoparticulate drug carriers (see Section 4.4.6).

### *Polymers prepared from aldehydes or by ring opening*

Several molecules containing a bond between two atoms of different electronegativity – either a double bond or a single bond included in a cycle with a sufficiently high ring strain – can be used as monomers in anionic polymerisation.

#### **Polymerisation of formaldehyde**

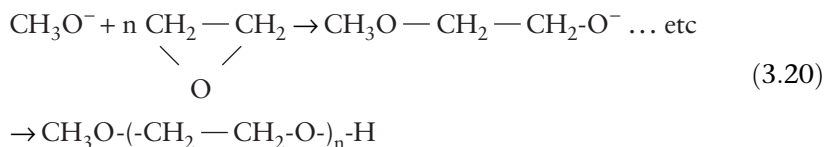
In aqueous medium, aldehydes are in equilibrium between monomeric and oligomeric forms. This is typically the case for formaldehyde. To obtain high-molecular-weight polymers, formaldehyde can be easily polymerised through ionic polymerisation. Initiation by methanolate ions is shown in Equation 3.19 and poly(methylene oxide) is obtained.



As the ceiling temperature of the polymer is rather low, depolymerisation is avoided by blocking the chain ends by reaction with carboxylic anhydrides (end-capping). The resulting end-capped poly(methylene oxide), e.g. Delrin®, is highly crystalline (melting temperature  $T_m = 175$  °C) and resistant to wear, shock and chemicals; it has been used for manufacturing tilting disks for valvular heart prostheses.

#### **Polymerisation of ethylene oxide**

Ethylene oxide contains a very tight cycle, and polymerisation of this gas is easy, as shown in Equation 3.20. The resulting poly(ethylene oxide) (PEO; see Box 3.2) is soluble in many solvents, including water and acetone.



#### **Polymerisation of hydroxyacid cyclic derivatives**

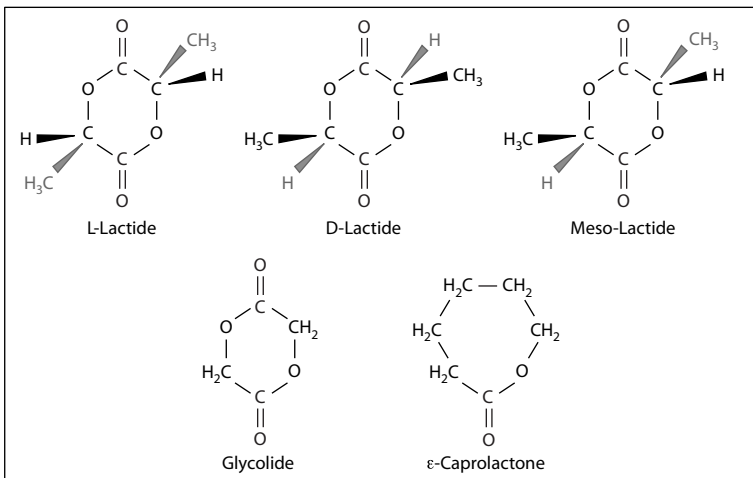
An ester bond is present in the main chain of many (bio)degradable polymers. During degradation in vivo, the products generated through hydrolysis are

**Box 3.2**

The repeating units of poly(ethylene oxide) (PEO) and poly(ethylene glycol) (PEG) are similar. As the methods used to synthesise these polymers are different, however, the chain ends and the range of molecular weight are different. PEO is obtained through anionic polymerisation. Only one end of the chains of PEO is an OH group, and PEO can be obtained within a wide range of molecular weight. PEG is obtained through cationic polymerisation (see Section 3.6.2). Both chain ends of PEG are OH groups, and the molecular weight of PEG is usually lower than the molecular weight of PEO.

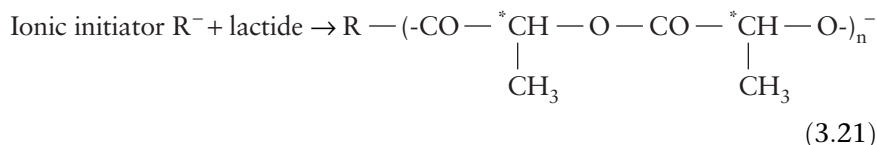
then metabolised (see Section 4.2.3). Such polymers have been synthesised for many years and were originally proposed as biodegradable materials for deep sutures. Glycolic and lactic acids, which are  $\alpha$ -hydroxyacids, could theoretically be polymerised by step polymerisation through dehydration. However, usually only low-molecular-weight polymers, i.e. oligomers, and cyclic dimeric forms, respectively called glycolide and lactides, are obtained, as shown in Figure 3.6. More recently, preparation of high-molecular-weight poly( $\alpha$ -hydroxyacids) by step polymerisation has been claimed.

The cyclic forms can be opened by nucleophilic attack of various initiators. Polymers often called poly(glycolic acid) and poly(lactic acid)s or, more properly, polyglycolide (PGA) and polylactides (PLA), or their copolymers (PLGA) can be obtained according to the main mechanism, as



**Figure 3.6** Some cyclic monomers leading to biodegradable polymers.

shown in Equation 3.21.



Among the initiators, tin (II) bis-2-ethylhexanoic acid (stannous octanoate) has been the most used for preparing biomedical and pharmaceutical polymers because of its low toxicity.

Following the development of PLGA, poly( $\epsilon$ -caprolactone) (PCL) has been synthesised by ring-opening polymerisation and also developed as a degradable polymer. Other synthetic polymers based on hydroxyacids such as malic acid and its derivatives have been proposed.

Besides these biodegradable polyesters prepared by chemical synthesis, a new class of biodegradable polyesters produced through biotechnology, the poly(alkanoates), is currently under development (see Section 4.2).

### Polyamides obtained by ring-opening polymerisation

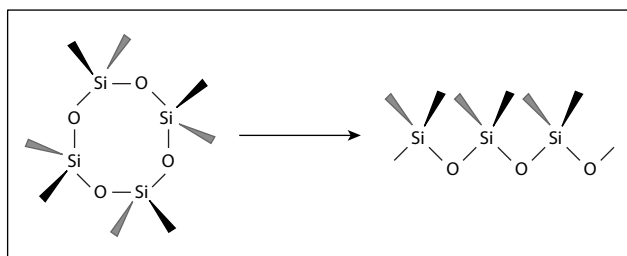
Polyamides are now synthesised mainly by ring-opening polymerisation. This is typically the case of polyamide 6, known as Nylon 6, which is prepared by ring opening and polymerisation of  $\epsilon$ -caprolactam, the cyclic amide very close to  $\epsilon$ -caprolactone.

### Silicones

Polysiloxanes, also referred to as silicones, are known for their very high flexibility (as their glass transition is around  $-127^\circ\text{C}$ ) and their high stability in diverse environments, including the biological environment. Poly(dimethylsiloxane) (PDMS) can be produced by ring-opening polymerisation of the cyclic tetramer octamethylcyclotetrasiloxane, as shown in Figure 3.7.

### 3.6.2 Cationic chain polymerisation

The active cationic reactive centres are borne by the end of the growing chain and are stabilised by small anions. However, the active cationic centres that



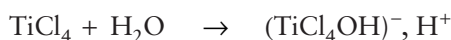
**Figure 3.7** Synthesis of poly(dimethylsiloxane) (PDMS) by ring-opening polymerisation.

correspond to a lack of electrons are far less stable than the active anionic centres, and many reactions of transfer and termination can take place. As a consequence, molecular weights of polymers obtained by cationic polymerisation are usually rather low.

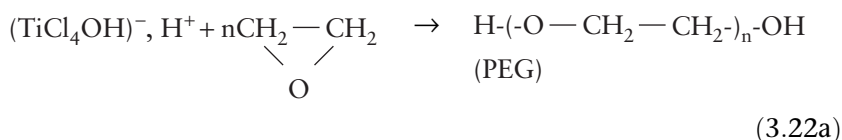
Monomers for cationic polymerisation comprise molecules with carbon-carbon double bonds bearing electro-donor substituents, e.g. isobutylene, and also small cycles. Cyclic ethers such as tetrahydrofuran, which is used as a solvent in anionic polymerisation, can act as a monomer in cationic polymerisation. Typically, chlorinated solvents are used in cationic polymerisation as the medium of polymerisation.

The initiating species are acids according to the definitions of either Brønsted or Lewis.

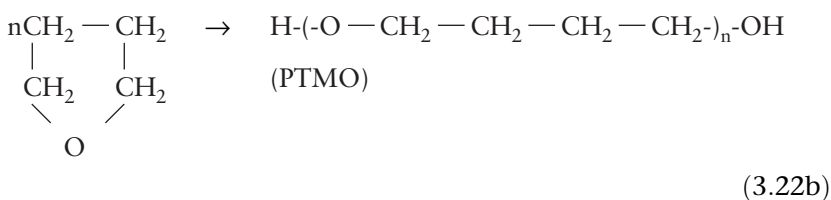
Syntheses of (PEG) and poly(tetramethylene oxide) (PTMO) can be initiated by  $\text{TiCl}_4$  in the presence of traces of water, as shown in Equation 3.22. PEG and PTMO, which possess one hydroxyl group at each chain end, can be used as prepolymers for synthesis of poly(ether urethane)s.



With ethylene oxide:



With tetrahydrofuran:



Ethyleneimine, which possesses the same tight structure as ethylene oxide, polymerises easily through a cationic mechanism. As the detailed mechanism is quite complex, poly(ethyleneimine) (PEI) is usually a branched polymer containing primary, secondary and tertiary amine groups in the approximate ratio 1 : 2 : 1. Synthesis by cationic polymerisation of linear PEI designed to be used for gene delivery has been reported.

### 3.6.3 Stereo-specific polymerisation

In the previously described methods of polymerisation, monomer addition takes place on an active centre in which spatial configuration is randomised.

As a consequence, configuration of the resulting polymers is also randomised. An example is given by atactic propylene obtained by radical polymerisation, which is highly amorphous.

Conversely, stereo-regular constant or alternate spatial configurations can be obtained if configuration of the active centre is either constant or changed alternately at each addition. To obtain such an effect, Ziegler and Natta, who won Nobel Prizes in 1963, developed a method to generate the initiating species on solid surfaces. In the initial patent, they claimed: ‘The catalysts are composed of compounds resulting from reaction of alkoylated derivatives of a metal belonging to groups from 1 to 3 with a compound comprising a transition metal belonging to groups from 4 to 8.’ In a typical example, the reagents are  $\text{AlEt}_3$  and  $\text{TiCl}_4$  and the mechanisms of polymerisation are likely ionic.

Polypropylene obtained by Ziegler–Natta polymerisation is isotactic and highly crystalline ( $T_m \approx 170\text{ }^\circ\text{C}$ ) and thus is endowed with very interesting mechanical properties.

Despite the fact that polyethylene does not possess any tacticity, ethylene can be polymerised in the presence of stereo-specific initiators. Polyethylene obtained by this method is linear and highly crystalline (HDPE), whereas polymerisation of ethylene obtained by radical polymerisation leads to a branched and thus more amorphous polymer (LDPE), as shown in Section 3.4.4.

### 3.7 Polymerisation reaction processes

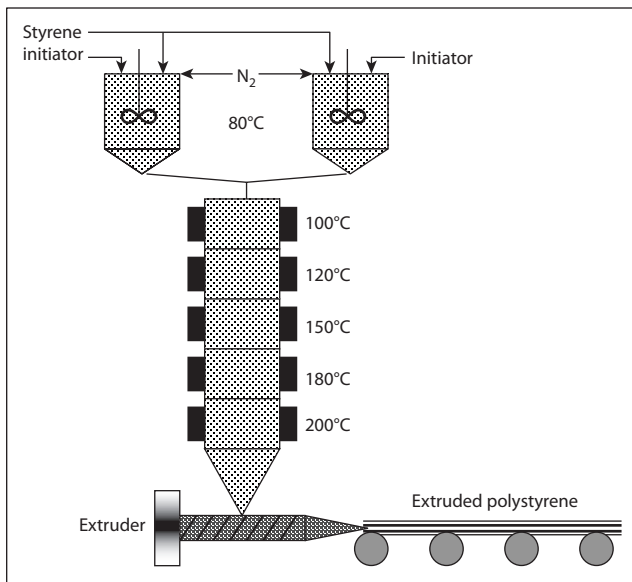
The conditions in which polymerisation takes place are very important, concerning for instance the physical form of the polymer that is obtained, the purpose of the form, the ‘quality’ of the polymeric material, and the costs in economical and environmental terms. Polymers can be prepared:

- in homogeneous systems, i.e. mass or bulk, or in solution
- in heterogeneous systems, i.e. suspension, emulsion or interfacial polymerisation.

#### 3.7.1 Polymerisation in homogenous systems

##### *Bulk polymerisation*

The system involved in the bulk polymerisation process is the simplest from the point of view of composition and is used for large-scale radical polymerisation. In this process, the initiator is mixed with the monomer, usually under pressure of an inert gas, and the mixture is heated to induce generation of free radicals by thermal decomposition of the initiator. Depending on whether the monomer is a gas or a liquid, the system can be homogenous or heterogeneous



**Figure 3.8** Industrial bulk polymerisation of styrene directly followed by extrusion.

at the end of polymerisation. An example of industrial bulk polymerisation is illustrated in Figure 3.8.

From an industrial point of view, this process has many advantages. The monomer is converted into polymer without the need to eliminate by-products. Continuous production of large amounts of polymer is possible. As polymerisation is exothermic, the polymer is usually in a molten state at the end of conversion, and its direct transformation into extruded products is easy.

However, this process is not devoid of drawbacks. As the medium is a bad heat transmitter, the heat generated by polymerisation has to be controlled carefully with efficient mixing in order to avoid heat spots leading to a ‘caramelised’ polymer. In addition, the viscosity of the polymerisation medium increases with conversion of the monomer into the polymer and is very high at the end of monomer conversion. The increasing temperature of the system contributes to the maintenance of viscosity at a level that makes mixing possible. However, as the concentration of the monomer in the system decreases from the beginning to the end of polymerisation, polymolecularity is rather high. In addition, traces of unconverted monomer can remain in the final product. Such a process is used to produce large amounts of cheap technical-grade polymers useful for instance as materials in civil engineering.

### *Polymerisation in solution*

In the solution polymerisation process, monomer and initiator are dissolved in a solvent and the solution is stirred. Thus, some of the drawbacks cited above,

especially those linked to the high viscosity at the end of conversion in the bulk polymerisation process, are solved in the present process. Complete conversion of monomer is easier and polymolecularity is not as wide as in the bulk process. The process in solution is also required in many ionic polymerisations.

However, new drawbacks are generated by the presence of solvent in this process. Side reactions such as transfer to solvent are possible. The solvent has to be eliminated as much as possible and recycled. Solvent residues can remain in the polymer. From an industrial point of view, this process is used only when the presence of solvent cannot be avoided.

### 3.7.2 Polymerisation in heterogeneous systems

There are different methods of polymerisation in heterogeneous systems. In general, such systems of polymerisation include two phases that either coexist from the beginning of the polymerisation or form during polymerisation because of phase separation of the forming polymer. This is in contrast with polymerisation in solution, which remains homogenous from the beginning to the end of the polymerisation. Compared with polymerisation in bulk or in solution, the main advantages for polymerisation in heterogeneous systems is that these systems provide much better conditions to control the polymerisation reaction and hence the final characteristics of the produced polymer. Low viscosity is maintained in the system, making control of stirring and temperature during the entire polymerisation easier. As a consequence, the polymerisation occurs more homogeneously from beginning to end than in the previously described systems, giving polymers of lower polymolecularity and copolymers of higher homogeneity in their composition and structure. At the end of polymerisation, the polymer is generally provided as beads, or sometimes as capsules, with many industrial applications. The size of the beads, which can vary from several nanometres to a few millimetres in diameter, depends greatly on the polymerisation system, which influences the mechanism of particle formation. It is noteworthy that emulsion polymerisations are now the most widely used methods applied in industry to prepare polymers and to obtain latexes.

The principal characteristics of the different modes of polymerisation in heterogeneous systems are summarised in Table 3.2.

Polymers can be produced by applying the various types of polymerisation mechanism described above, i.e. all radical polymerisations including controlled polymerisation and ionic polymerisation. In addition to producing polymers with well-defined characteristics, polymerisation in heterogeneous systems can be used to produce well-defined polymer particles including very well-structured composite nanoparticles. For instance, particles with a magnetic core and nanoparticles showing a core-shell-type nanostructure can be



**Table 3.2 Main processes of polymerisation in heterogeneous systems**

Process	Main characteristics of initial system	Main characteristics of reaction	Main characteristics of final system
Suspension	Monomer with dissolved initiator roughly dispersed in a continuous phase with a low amount of surfactant	Polymerisation initiated in monomer droplets; droplets converted into polymer particles	Large polymer particles (diameter 10–1000 $\mu\text{m}$ )
Dispersion	Monomer and initiator dissolved in appropriate solvent to prepare homogenous solution	Polymerisation initiated in solution; insoluble polymer precipitates as particles	Polymer particles of several micrometres in diameter
Emulsion	Monomer droplets stabilised by low amount of surfactant, dispersed in continuous phase in which the initiator is dissolved; monomer slightly soluble in continuous phase	Polymerisation initiated in continuous phase; growing chains formed in continuous phase precipitate nucleating polymer particles; chains continue to grow in nucleated particles; polymerisation 24–48 h	Diameter of largest particles is a few micrometres; larger particles can be obtained by seeding and feeding with a further amount of monomer; composite or structured particles can be obtained
Mini-emulsion	Tiny monomer droplets dispersed in continuous phase with surfactant and hydrophobic compound; emulsions produced using high shear rates or ultrasound; initiator dissolved in either monomer droplets or continuous phase	Polymerisation initiated in mini-emulsion droplets; each mini-emulsion droplet behaves like a nano-reactor; high rate of polymerisation	Particles in the size range 5–500 nm, with a narrow size distribution; high molecular weight of resulting polymers; composite or structured particles can be obtained
Micro-emulsion	Swollen monomer micelles dispersed in a continuous phase; fairly large concentrations of surfactants required; initiator dissolved in continuous phase	Polymerisation initiated in the course of nucleation of monomer micelles; process characterised by continuous nucleation during entire reaction; fast rate of polymerisation (< 30 min)	Particles of very small size (diameter < 100 nm) and narrow distribution; polymer with ultra-high molecular weight (> $10^7$ g/mol); copolymers with well-defined, homogenous composition

synthesised by these methods. Particles with even more complex nanostructures can be synthesised. Such micro- and nanoparticles, including capsules, have a use in drug-delivery systems with controlled biodistribution and drug-releasing patterns and as tools for diagnosis by imaging methods.

### Suspension polymerisation

In the process of suspension polymerisation, the monomer is dispersed by vigorous stirring into a medium in which it is not soluble. As many monomers are hydrophobic, the medium is most often water. An important feature is the presence of initiator in the monomer droplets. A surfactant is used to stabilise the droplets and standardise their size. Mineral salts are added to the water to decrease the solubility of the monomer in water as much as possible.

This process has many advantages, as thermal control is excellent in water and the viscosity of the medium remains low and constant. Each droplet of monomer is converted directly into a polymer bead. Provided that the size of the droplets is well controlled, polymer beads of defined size, e.g. in the range 10–1000  $\mu\text{m}$ , are obtained at the end of conversion. This permits easy storage and feeding of moulding machines for transformation into objects. An example of an industrial process for suspension polymerisation is presented in Figure 3.9.

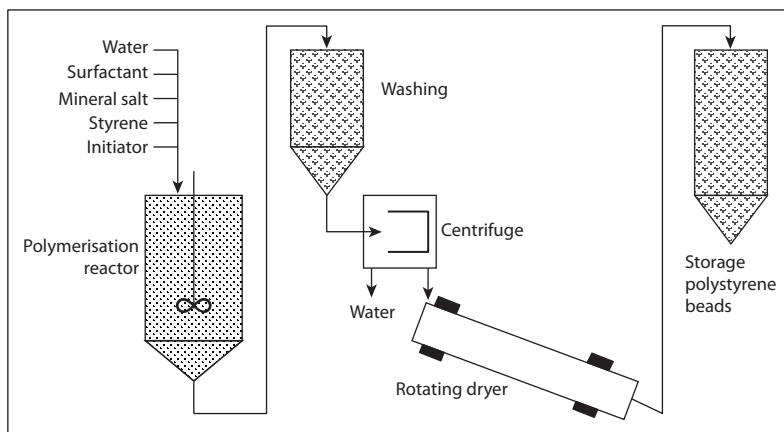
The dispersing medium has to be eliminated and recycled. When an aqueous medium is used, the beads have to be washed to eliminate salts and surfactants and then dried.

This process is not easy to adapt to continuous production and is energy-consuming, but it allows production of large amounts of good-quality polymers.

Inverse suspension polymerisation is a convenient way to obtain microspheres of hydrophilic polymers. More details about the use of microspheres for therapeutic embolisation are found in Section 4.3.8.

### Emulsion, mini-emulsion and micro-emulsion polymerisations

Emulsion polymerisation was initially developed for producing synthetic rubber from butadiene and styrene during the Second World War. The system

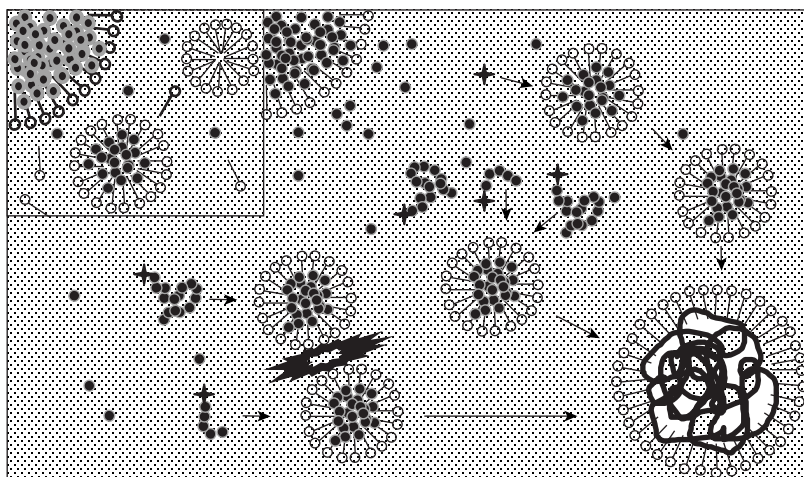


**Figure 3.9** Industrial suspension polymerisation of styrene.

used in emulsion polymerisation is very close to the previously described system in the sense that the monomer is dispersed in a medium, usually water, in which its solubility is low or very low, a surfactant is present and the medium is stirred. Unlike in the suspension polymerisation process, however, nothing is done to avoid the presence of soluble monomer in water, as the initiator is water-soluble. Thus, polymerisation is initiated in water and the polymeric chains stabilised by surfactants grow in the aqueous phase. The monomer is present in equilibrium between rather large droplets acting as reservoirs, micelles of monomer, monomer in low concentration in water, and micelles of growing polymer. Depending on the concentration of surfactant in the medium, the polymeric micelles can more or less combine together, leading to formation of a colloidal suspension of submicronic particles, i.e. latex or nanoparticles, usually in the size range 50–1000 nm. A model of emulsion polymerisation is presented in Figure 3.10.

To obtain larger particles, it is possible to use a seed process and to induce polymerisation of a further amount of monomer on the seed particles. Note that this process can be used to obtain composite or structured particles.

Mini-emulsion is a variant of emulsion polymerisation. Tiny stabilised monomer droplets are dispersed in a continuous phase. Emulsions are produced by using either high shear rates (high pressure homogeniser) or ultrasound. Such high rates of agitation are required to reach a steady state given by the balance between droplet fission and fusion. The high stability of these emulsions can be explained by the inhibition of inter-droplet mass transfer phenomenon, i.e. Oswald ripening. The choice of surfactant and the addition



**Figure 3.10** Preparation of latex (nanoparticles) through emulsion polymerisation. Insert: in the absence of initiator, equilibrium between monomer droplets, monomer in solution, and micelles of surfactant with or without monomer. Main figure: after initiation by the active species (star), distribution of monomer between the different forms, either solution, or micelles or particles.

of a hydrophobic compound are critical in the formulation of such polymerisation systems. The hydrophobic compound can be chosen from among transfer agents or initiators of polymerisation therefore being active in the polymerisation process, but its principal role is to counterbalance the Laplace pressure of the droplets, responsible for fusion of droplets. This process can also be used to obtain composite or structured particles.

Micro-emulsion is another variant of emulsion polymerisation. Such emulsions are thermodynamically stable systems including swollen monomer micelles dispersed in a continuous phase. In general, they require fairly large concentrations of surfactants to be produced compared with the other dispersed polymerisation systems. Hence, the interfacial tension of the oil/water is generally close to zero. Polymers with ultra-high molecular weight, i.e. above  $10^7$  g/mol, can be obtained, as can copolymers with a very well-defined, homogenous composition. Whereas polymerisation can take 24–48 h in the normal emulsion process, it proceeds at a fast rate in micro-emulsion, as total conversion can be obtained in less than 30 min. Polymer particles of very small size (diameter  $< 100$  nm) and narrow distribution can be obtained by this process.

Recovery of solid polymer can be obtained by coagulation of the latex. As the size of the particles is submicronic, recovery by filtration without precipitation is not possible. Separation without precipitation cannot be obtained by usual centrifugation but requires ultracentrifugation. The emulsion polymerisation process is very well adapted for production of large amounts of polymeric colloids used in the paint industry by polymerisation of acrylic and methacrylic monomers, i.e. acrylic paints. Similarly, poly(alkylcyanoacrylate) nanoparticles can be obtained by such a process.

It is noteworthy that each particle is covered at the end of synthesis both by the hydrophilic fragment resulting from decomposition of the initiator, e.g. sulphate groups, and by the surfactant. Both entities participate in the stability of the colloidal suspension. Emulsion polymerisation of a hydrophobic monomer in aqueous medium is sometimes referred as oil-in-water (o/w), whereas emulsion polymerisation of a hydrophilic monomer, e.g. an acrylamide, in a non-polar organic solvent is referred to as inverse emulsion polymerisation or water-in-oil (w/o). More details about the use of nanospheres for drug delivery can be found in Section 4.4.6.

### *Interfacial polymerisation*

Similarly to suspension and emulsion polymerisation, the system used in interfacial polymerisation is heterogeneous, but polymerisation takes place at the interface between both phases. Such a system can be easily illustrated in a practical laboratory course by reaction of a diamine soluble in an aqueous alkaline medium present in the upper part of a beaker, with a diacid chloride soluble in a non-miscible organic solvent such as chloroform present in the

lower part of the beaker. A tiny film of polyamide is formed at the interface and can be recovered. Other polymers can be prepared by such a process, but the large amount of solvents that must be used and recovered limits its commercial utility for preparing large amounts of polymers.

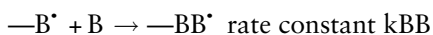
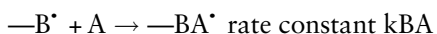
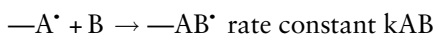
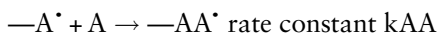
However, this is not the case when considering the encapsulation of drugs, proteins, nucleotides and even cells for biotechnology. More details about the use of nanocapsules for drug delivery can be found in Section 4.4.6.

### 3.8 Copolymerisation

Despite the fact that many polymers obtained by step polymerisation are real alternate copolymers, most copolymers are prepared by chain polymerisation. Chain copolymerisation is very important from a technological point of view, as it increases the possibility of preparing polymers endowed with properties that cannot be obtained with homopolymers. In addition, as the probability of obtaining significant cohesive properties by mixing polymers to prepare blends or alloys is very low, copolymerisation can provide covalent binding between separated phases. Random or alternating copolymers can usually be obtained by a classical radical chain polymerisation in a single step, while preparation of block and graft copolymers usually needs at least two steps.

#### 3.8.1 Random and alternate radical copolymerisation

When two monomers A and B are mixed and radical polymerisation is initiated, four propagation reactions are possible:



Thus, composition of the copolymers depends on the reactivity of monomers A and B with the reactive centres and on the composition of the monomer mixture, which can vary with conversion.

Reactivity ratios can be defined as follows:  $r_A = k_{AA}/k_{AB}$  and  $r_B = k_{BB}/k_{BA}$ .

*Simple cases:  $r_A = r_B$*

When  $r_A = r_B$ , the composition of both the mixture of monomers and the copolymer does not depend on conversion.

When  $r_A = r_B = 1$ , this means that A or B has a similar reactivity towards  $\text{—A}^\bullet$  and  $\text{—B}^\bullet$ . As a result, instant composition of the copolymer is ideally random.

When  $r_A = r_B < 0.01$ , this means that the reactivity of A on  $\text{—B}^\bullet$  is far higher than on  $\text{—A}^\bullet$ , and the reactivity of B on  $\text{—A}^\bullet$  is far higher than on  $\text{—B}^\bullet$ . The resulting copolymer is strongly alternate.

When  $r_A = r_B \gg 1$ , the copolymer tends to contain blocks, and the limit is simultaneous homopolymerisation of both monomers, but this case is very uncommon.

#### *General case: $r_A$ and $r_B$ are different from each other*

Let us consider that monomer A is bound faster than B to active centres. The result is that the concentration of A in the monomer mixture decreases when conversion increases. Consequently, the composition of copolymers formed at the beginning and at the end of conversion is very different when nothing is done to compensate for the preferential consumption. From an industrial point of view, such heterogeneity in the composition of a batch of copolymer can be a real drawback.

Copolymerisation is not limited to mixtures of two monomers, and the simultaneous polymerisation of three monomers, or terpolymerisation, is commercially used to further improve properties of copolymers. Quantitative treatment of nine propagation reactions is quite complex and beyond the scope of this book.

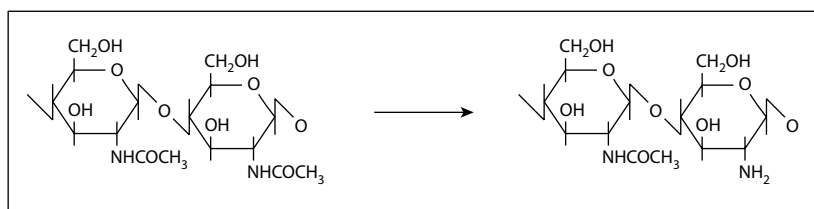
### **3.8.2 Synthesis of block and graft copolymers**

Synthesis of block copolymers with well-defined structure has received considerable attention, as their properties are potentially of great interest (see Section 4.1). Until recently, the possibilities were limited to the use of either sequential addition of monomers in 'living' anionic polymerisation systems, or coupling of polymers possessing reactive ends, e.g. telechelic polymers. Advances in radical controlled polymerisation have opened new perspectives.

Graft copolymers contain a long sequence composed of one polymer, i.e. the backbone, with branches or grafted sequences composed of another polymer. Different methods, such as radical chain transfer, irradiation, redox initiation and ionic initiations, have been used to induce grafting on to different backbones such as cellulose in order to modify their properties.

### **3.9 Modifications of polymers**

A large number of polymers cannot be obtained by polymerisation of monomers but are obtained by chemical modification of polymers from either natural or synthetic origin. The first objects manufactured from polymers were obtained from chemically modified natural polymers. The chemical modifications are usually performed through classical reactions of organic chemistry, such as esterification, hydrolysis or etherification. However, the reactivity of chemical groups linked to polymers is not similar to the reactivity of the same groups present in small molecules, as the distance between polymer-linked



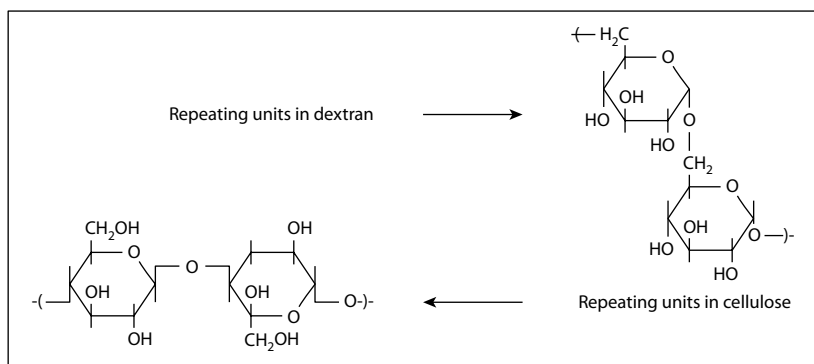
**Figure 3.11** Repeating units in chitin and chitosan (partly de-acetylated chitin).

groups cannot be changed, resulting in ‘neighbouring’ effects. Moreover, physical characteristics of polymers, such as crystallinity and hydrophobicity, have a strong influence on the reactivity of polymer-linked groups.

Polysaccharides are natural polymers that are highly diverse and used widely as they are or after modification in the biomedical and pharmaceutical fields. Among the polysaccharides, cellulose is the most abundant, as it represents about one-third of all plant matter. Cellulose fibres have been used for centuries without major modification, but for many uses cellulose has been chemically modified to be easily manufactured. Chitin, the major constituent of crab shells, is probably the second most abundant polysaccharide. Before being used, chitin has to be de-acetylated, resulting in chitosan, as shown in Figure 3.11. Chitin de-acetylated over 70% is water-soluble.

### 3.9.1 Modifications of cellulose and other polysaccharides

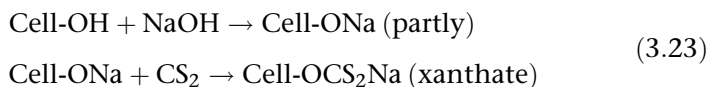
Cellulose and dextran, shown in Figure 3.12, are natural polymers of glucose. Their molecular weights can be very high, up to  $1\text{--}2 \times 10^6$  g/mol. Dextran, in which the glucose units are linked by (1→6) linkages, is water-soluble. Despite the high hydrophilicity of cellulose, which can retain 70% of its weight in water, cellulose is not water-soluble. The structure of cellulose is very regular and the  $\beta$ -(1→4) linkages are rigid. Thus, formation of a large number of strong hydrogen bonds between chains is possible. This results in a high crystallinity, insolubility and strong cohesive properties; in addition,



**Figure 3.12** Repeating units in some natural polymers of glucose, i.e. dextran and cellulose.

when heated, cellulose decomposes without flowing or melting. The OH groups of cellulose are poorly accessible and not very reactive.

These properties impair the use of native cellulose in the manufacture of useful products, except those made of threads. Modifications of cellulose usually require the cellulose to be solubilised. In the viscose process, cellulose is treated with 18–20% aqueous sodium hydroxide. The mass is aged to allow oxidative degradation of the chains in order to reduce molecular weight. Then the alkali cellulose is treated with carbon disulfide, leading to the soluble sodium xanthate derivative of cellulose, as shown in Equation 3.23.



Coagulation of xanthate is performed in 10% aqueous sulphuric acid. The xanthic acid derivative that is formed is not stable and is decomposed, and cellulose is regenerated. Viscose rayon fibres and cellophane films have been produced by this method.

Regenerated cellulose films and hollow fibres used in haemodialysers have been prepared by a method known as the cuprammonium process. Cellulose is dissolved in a solution of ammonia and cupric oxide. The complex cupric salts are water-soluble and cellulose is regenerated by treatment with acid. Cuprophan<sup>®</sup> is prepared by this process.

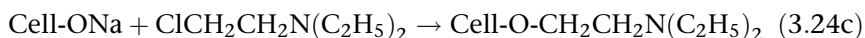
Many cellulose esters have been developed. They include acetates, acetopropionates, acetobutyrate and nitrates. As the crystallinity of cellulose is suppressed by such substitutions, the esters are thermoplastic and can be manufactured by usual methods, e.g. extrusion or moulding. Properties of these compounds depend on the type of substituent and on the degree of substitution. Cellulose nitrates were the first modified polymers. Depending on the degree of substitution, different applications have been developed: Highly nitrated cellulose is a well-known explosive, whereas a little less substituted cellulose is used as solid fuel for rockets and the least substituted cellulose is a thermoplastic called celluloid. Celluloid was used to make films for early movies and moulded objects, e.g. dolls and table tennis balls. However, as celluloid is highly flammable, other esters have almost completely replaced cellulose nitrates for manufacturing everyday objects.

Cellulose acetates are now the most important derivatives and are obtained by reaction of acetic anhydride on cellulose. As this reaction occurs in a heterogeneous system, some chains are completely substituted, even at the beginning of the reaction, whereas others are not substituted at all. Thus, the triacetate is first prepared and less acetylated derivatives are prepared by controlled hydrolysis of the triacetate. Cellulose acetates are used widely in



everyday life. In the biomedical field, partially acetylated cellulose is used as a constituent of haemodialysis membranes (see Section 4.3.6). In pharmaceutical technology, the mixed esters are used as excipients for the oral route (see Section 4.4).

Cellulose ethers, e.g. the methyl, carboxymethyl and diethylaminoethyl (DEAE) ethers, are prepared by successive reactions with concentrated aqueous sodium hydroxide and then with the halide derivative, as shown in Equation 3.24.



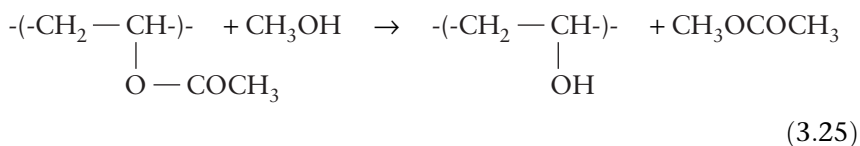
Cellulose ethers have found many applications in industry, including the pharmaceutical industry. Cellulose membranes partially substituted with DEAE groups, Hemophan<sup>®</sup>, have been used in haemodialysis devices.

Many graft copolymers can be obtained by creating active radical centres capable of initiating polymerisation of vinylic or acrylic monomers on the cellulose backbone. The properties of cellulose are completely modified by the presence of these grafted chains.

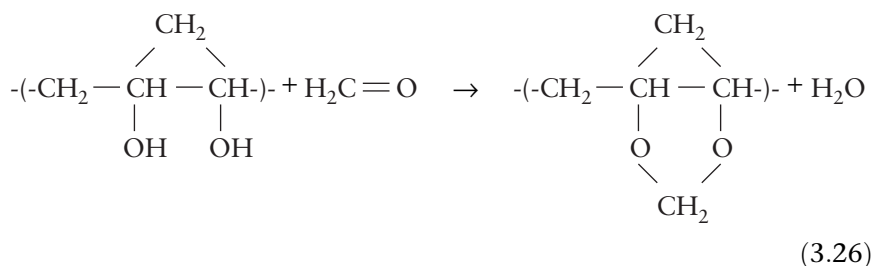
All of these modifications can be applied to other polysaccharides and to hydroxyl-bearing polymers.

### 3.9.2 Modifications of poly(vinyl acetate)

As the monomer vinyl alcohol does not exist, because it is not stable, poly(vinyl alcohol) can be prepared from poly(vinyl acetate), for instance by transesterification in methanol, as shown in Equation 3.25.



Poly(vinyl formal) and poly(vinyl butyral) are prepared by reaction of poly(vinyl alcohol) with the corresponding aldehydes, as shown in Equation 3.26.



## Bibliography

### General

Allen G, Bevington JC, eds (1989). *Comprehensive Polymer Science*. London: Pergamon Press.  
Brandrup J, Immergut JH, Grulke EA, eds (1999). *Polymer Handbook*, 4th edn. New York: John Wiley & Sons.

### Synthesis, methods and processes

Braun D, Cherdrón H, Rehahn M, Ritter H, Voit B (2005). *Polymer Synthesis: Theory and Practice, Fundamentals, Methods, Experiments*, 4th edn. Berlin, New York: Springer.  
Candau F, Pabon M, Anquetil JY (1999). Polymerizable microemulsions: some criteria to achieve an optimal formulation. *Colloids Surf A Physicochem Eng Asp* 153: 47–59.  
Landfester K (2001). Polyreactions in miniemulsions. *Macromol Rapid Commun* 22: 896–936.  
Mecking S (2007). Polymer dispersions from catalytic polymerisation in aqueous systems. *Colloid Polym Sci* 285: 605–619.  
Odian G (2004). *Principles of Polymerization*, 4th edn. Hoboken, NJ: Wiley-Interscience.  
Pichot C, Daniel JC, eds (2006). *Latex Synthétiques: Elaboration-Propriétés-Applications*. Paris: Lavoisier.



# 4

## Special properties of polymers, case studies and detailed examples of applications

---

4.1 Properties of block copolymers: phase separation in solution and at solid state	87	4.3 Applications of polymers in biomedical uses	98
4.2 Biodegradable and bioerodible polymers	91	4.4 Applications of polymers in pharmaceutical uses	114
		Bibliography	148

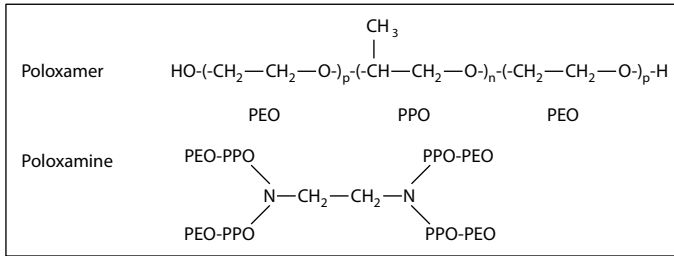
---

### 4.1 Properties of block copolymers: phase separation in solution and at solid state

Homopolymers are usually not miscible; hence, blending homopolymers generally leads to phase-separated large domains. As there are only weak interactions between phases, such systems are weakly cohesive. In block copolymers, blocks are also phase-separated but they are linked together by covalent bonds. Thus, solutions and solids composed of such systems possess special properties owing to the presence of the linkages between blocks. The organisation of the micro-domains formed by block copolymers and properties in solutions and in the solid state depend on the composition, structure, molecular weight and properties of the blocks. A few examples of their properties are presented below.

#### 4.1.1 Solution properties

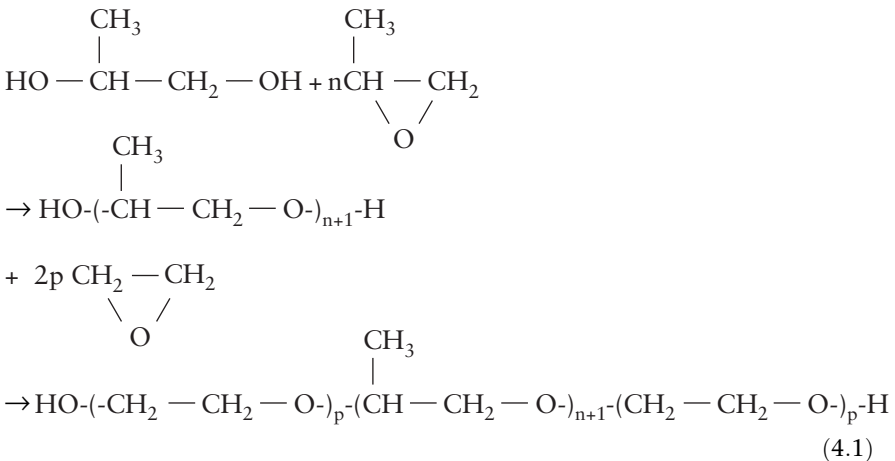
Block copolymers composed of two or three hydrophilic and hydrophobic blocks possess amphiphilic properties and are used widely as non-ionic surfactants. Ploxamers are triblock copolymers polyoxyethylene-polyoxypropylene-polyoxyethylene (PEO-PPO-PEO), commercially known



**Figure 4.1** Repeating units in poloxamers and poloxamines.

as Pluronic<sup>®</sup>. Poloxamines, commercially known as Tetronic<sup>®</sup>, are composed of a central unit of ethylenediamine, denoted Y, on which four arms of PPO–PEO are linked  $[Y(\text{PPO}_n\text{-PEO}_p)_4]$ , as shown in Figure 4.1.

Synthesis of poloxamers begins with creation of the hydrophobic block by addition of propylene oxide to propylene glycol. Then the hydrophilic blocks are added by polymerisation of ethylene oxide, as shown in Equation 4.1.



The total molecular weight of poloxamers can vary from 1000 g/mol to 16 000 g/mol, and the hydrophilic segment can comprise between 15% and 90% of the molecule. Box 4.1 describes the code names of poloxamers.

When poloxamers are introduced into water at a low concentration, the soluble species are only isolated hydrated molecules. When the concentration of a copolymer is increased at constant temperature above the critical micelle concentration (CMC), micelles composed of several molecules are formed. In aqueous medium, such micelles are endowed with a core-shell structure composed of a hydrophobic core and a hydrophilic shell. The equilibrium is illustrated in Figure 4.2.

CMC depends on the copolymer, the solvent and the temperature. Unexpectedly, solubility is greater in cold than in warm water. Hydrogen bonds are formed between the oxygen atoms of the macromolecule and

**Box 4.1**

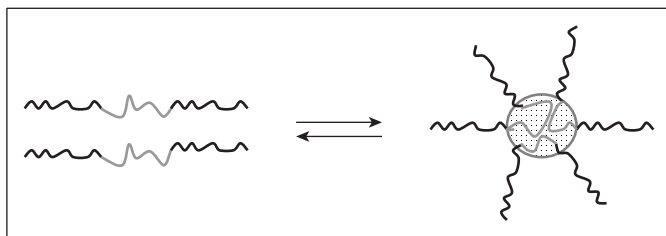
Composition of the poloxamer molecule is indicated by the code name. The approximate molecular weight of the hydrophobic segment is given by the first two digits of the poloxamer number, multiplied by 100. The approximate percentage of polyoxyethylene (PEO) of the final molecular weight is given by the last digit, multiplied by 10. Some confusion can arise from the fact that the code names of poloxamers and Pluronics® are different. In Pluronics, the physical state is indicated by the associated capital letter.

As an example, poloxamer 407 (Pluronic F127) is a solid derived from a 4000 PPO, comprising around 70% of PEO in the final molecular weight, which is around 12 000; poloxamer 407 is water-soluble.

surrounding water. When the temperature increases, some of these bonds are broken, decreasing the solubility. This effect, together with micelle formation, can result in reversible gelation. For instance, aqueous poloxamer 407 solutions are liquid below 25 °C and can jellify at higher temperatures at a concentration of at least 20%. This phenomenon is even more marked when the polymolecularity of the poloxamer is reduced.

At a constant temperature in aqueous medium, CMC decreases when the length of the hydrophobic chain increases and can become very low. For this reason, nanoparticles are formed readily in aqueous medium from block copolymers possessing fairly long hydrophobic chains. Such large block copolymers can be considered as polymeric surfactants.

Toxicological studies have shown that low-molecular-weight poloxamers are only slightly toxic, whereas those with a high molecular weight can be considered non-toxic. These results allow the use of poloxamers in contact with living tissues. They have been used as additives in contact lenses, artificial tears and ophthalmic drug solutions. For instance, poloxamer 407 has been proposed to increase the efficacy of drugs by increasing the duration of contact with the cornea. A poloxamer 407 of low polymolecularity has been developed



**Figure 4.2** Equilibrium between free molecules and micelles above the critical micelle concentration (CMC).

that permits temporary embolisation of a blood vessel without clamping. A cold solution of this poloxamer is injected in the liquid state into the vessel. At body temperature, the vessel is embolised by instant gelation of poloxamer solution. After surgery, gelation is reversed by local cooling, resulting in reopening of the vessel and solubilisation of the poloxamer into the blood.

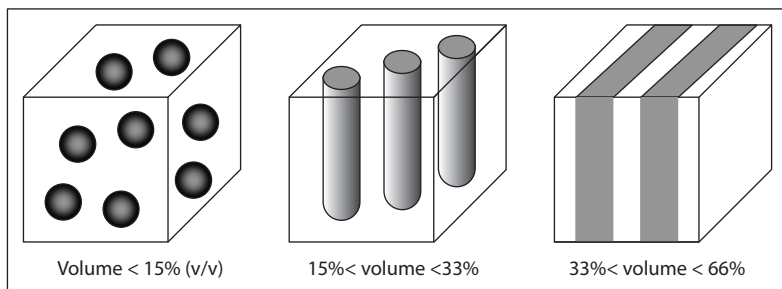
#### 4.1.2 Block copolymers in phase-separated materials

Because of their unique properties, block copolymers are increasingly used commercially, either as materials themselves or as additives in polymeric alloys. The most developed systems have been copolymers composed of two or three monomer units with two or three blocks. In the solid state, block copolymers are phase-separated, and hence they can be considered as solid emulsions. The different types of structure of the materials and the resulting properties depend on both the structure and the composition of copolymer, as exemplified in the case of diblock (SB) and triblock (SBS) copolymers of styrene and butadiene, illustrated in Figure 4.3.

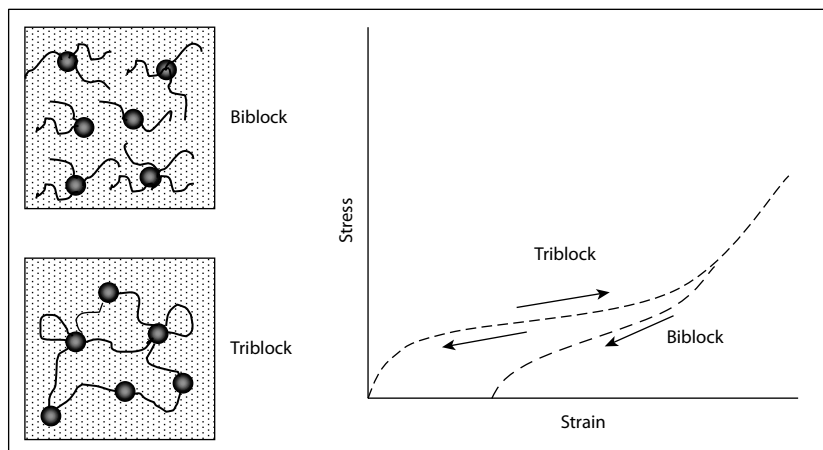
When the percentage of polystyrene is below 15% of the total volume, spherical nodules of polystyrene are dispersed in the matrix of polybutadiene. The larger the molecular weights, the larger the nodules. When the percentage of polystyrene is between 15% and 33%, cylinders of polystyrene are dispersed in the matrix of polybutadiene. The structure of the material is lamellar when the percentage of polystyrene is between 33% and 66%. When the percentage of polystyrene is increased further, the dispersed phase is composed of polybutadiene in a matrix of polystyrene.

The mechanical properties of the materials composed of the diblock and triblock copolymers are different, as shown schematically in Figure 4.4.

Indeed, in the case of a diblock containing a high percentage of polybutadiene, the nodules of polystyrene are completely independent. The stress/strain response of the material made of such a copolymer is similar to the response of polybutadiene, i.e. a non-vulcanised elastomer, which does not recover its initial length after elongation. In the case of a triblock SBS of



**Figure 4.3** Structural organisation of solid block copolymers poly(styrene)-poly(butadiene) as a function of composition.



**Figure 4.4** Structural organisation and stress/strain behaviour of biblock and triblock copolymers of styrene and butadiene of similar composition.

similar composition, however, polybutadiene chains can act as links between nodules composed of polystyrene, generating physical cross-linking. The stress/strain response is the response of a vulcanised rubber, which recovers its initial length after elongation.

The main advantage of such triblock copolymers is that they can be moulded and recycled simply by heating the material above the glass transition temperature of polystyrene, unlike classical vulcanised rubbers, which cannot be reused without degradation as they are chemically cross-linked. Such SBS-based materials are called thermoplastic elastomers. However, for various reasons, including cost, the commercial use of such polymers is rather limited compared with the use of natural and classical synthetic rubbers.

This is not the case for copolymers containing a majority of styrene units (high-impact polystyrene) and for terpolymers composed of acrylonitrile, butadiene and styrene (ABS), which are used widely as shock absorbers. The latter is a cohesive polymeric alloy stabilised by distribution of the different chains between phases.

This example shows that block copolymers can act as polymeric surfactants to stabilise polymeric mixtures of homopolymers, providing that the constituents of the blocks are similar to those constituting the homopolymers.

## 4.2 Biodegradable and bioerodible polymers

Biodegradable polymers were developed originally for biomedical and pharmaceutical uses. The aim was to obtain materials for temporary or repeated use and that degraded *in vivo* with a controlled rate into non-toxic products that could be eliminated through natural ways. For such uses, only small amounts of high-grade polymers were required, and the initial high cost of



such polymers was a small issue when compared with the expected properties. Then biodegradable polymers were developed in order to solve environmental concerns, e.g. to avoid non-degradable polymer-based wastes polluting the landscape. In this case, the aim was to obtain materials for general uses, such as packaging and agriculture, and that degraded outside. Unlike for biomedical uses, large amounts of technical-grade polymers and low cost were required.

This chapter focuses on biodegradable polymers used in the health domain. Some examples of biodegradable and bioerodible polymers are presented in Table 4.1, and some of their thermomechanical properties are given in Table 4.2.

**Table 4.1** Some biodegradable and bioerodible polymers

Name	Abbreviation	Repeating unit	Polymerisation
Poly(glycolide) or poly(glycolic acid)	PGA	$-(\text{O}-\text{CH}_2-\text{CO})-$	Synthetic
Poly(lactides) or poly(lactic acids)	PLA	$-(\text{O}-\overset{*}{\text{C}}\text{H}(\text{CH}_3)-\text{CO})-$	Synthetic
Poly(3-hydroxybutyrate)	P3HB	$-(\text{O}-\overset{*}{\text{C}}\text{H}(\text{CH}_2-\text{CH}_2-\text{CO})-\text{CO})-$	Biosynthetic
Poly(3-hydroxyvalerate)	P3HV	$-(\text{O}-\overset{*}{\text{C}}\text{H}(\text{CH}_2-\text{CH}_2-\text{CO})-\text{CO})-$	Biosynthetic
Poly(4-hydroxybutyrate)	P4HB	$-(\text{O}-\text{CH}_2-\text{CH}_2-\text{CH}_2-\text{CO})-$	Biosynthetic
Poly(malic acids)	PMA	$-(\text{O}-\overset{*}{\text{C}}\text{H}(\text{CH}_2-\text{CO})-\text{COOH})-$	Synthetic
Poly( $\epsilon$ -caprolactone)	PCL	$[-(\text{O}-(\text{CH}_2)_5-\text{CO})-]$	Synthetic
Poly(sebacic acid)	PSA	$[-(\text{O}-\text{CO}-(\text{CH}_2)_8-\text{CO})-]$	Synthetic
Poly[1,3-bis( <i>p</i> -carboxy-phenoxy)propane]	PCPP	$[-(\text{O}-\text{CO}-\varphi-\text{O}-(\text{CH}_2)_3-\text{O}-\varphi-\text{CO})-]$	Synthetic
Poly(butylcyanoacrylate)	PBCA	$-(\text{CH}_2-\overset{\text{C} \equiv \text{N}}{\underset{\text{COOC}_4\text{H}_9}{\text{C}}})_n-$	Synthetic

**Table 4.2 Thermomechanical properties of some biodegradable polymers**

Polymer	$T_g$ (°C)	$T_m$ (°C)	Modulus (GPa)
PGA	35	225	6.5
PGA (fibres)	–	233	13.4
PLA50	55	a*	2–3.6
PLLA	60	180	2.1
PLLA (fibres)	60	187	8.5–10.4
PCL	–60	55	0.3
P3HB	1	171	2.5
PHB-co-PHV	–5/–1	137–160	0.6–1.4

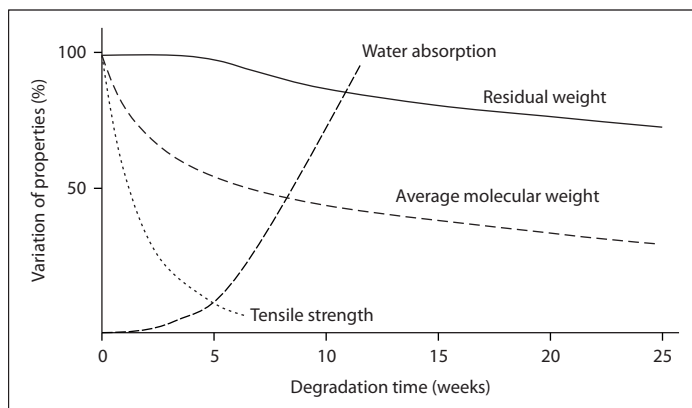
a\* = amorphous.

Designing a true biodegradable polymer is theoretically simple. This can be obtained by introducing into the main chain of the polymer a type of bond that can be cleaved *in vivo*. Depending on the requirements concerning the site of degradation, such bonds can be sensitive to non-specific hydrolysis, e.g. esters or anhydrides, or to a specific enzymatic cleavage, e.g. peptide bonds. A controlled decrease of molecular weight with time and production of small molecules that are easy to eliminate are expected.

Polyglycolide or poly(glycolic acid) (PGA) wires were proposed under the trade names Dexon<sup>®</sup> and Ercedex<sup>®</sup> in the 1960s to replace ‘catgut’ used for deep sutures. Then polylactides (PLA), also known as poly(lactic acid)s, and copolymers of lactides and glycolide (PLGA) were developed for different fibre-based devices under the trade names Vicryl<sup>®</sup> and Glactine910<sup>®</sup>.

As shown in Section 3.6.1, synthesis of these polymers starts from lactides and glycolide, which are dilactones resulting from cyclisation of the hydroxy-acids by dehydration. As an asymmetric carbon is present in lactic acid, two asymmetric carbons are present in lactides. Thus, when starting from the natural L-lactic acid, only one L,L-lactide is expected, whereas three different lactides, L,L-, D,D- and D,L-, are obtained from the synthetic lactic acid (see Figure 3.6). Ring-opening polymerisation of L,L-lactide in non-racemising conditions, for instance by using tin octanoate as the initiator, leads to poly-(L,L-lactide) (PLLA), whereas poly(D,L-lactide) (PLA50 or racemic PLA) is obtained from the racemic mixture of lactides.

Catgut has now been completely replaced by PLA and PLGA wires and meshes, which are degraded at a controlled and reproducible rate. Copolymers of different compositions have found their use in different domains, such as sutures, bone surgery, tissue reconstruction and drug-delivery systems, depending on their thermomechanical properties and



**Figure 4.5** Degradation of poly(L,L-lactide) (PLLA) in aqueous medium: variation of several parameters with time.

degradation rate. Another important property that makes such polymers attractive is the fact that they are expected to form final endogenous degradation products that can be metabolised, resulting in water and carbon dioxide. Finally, possible immune responses that may occur when using materials from natural origin are not encountered with PLGA owing to its synthetic nature.

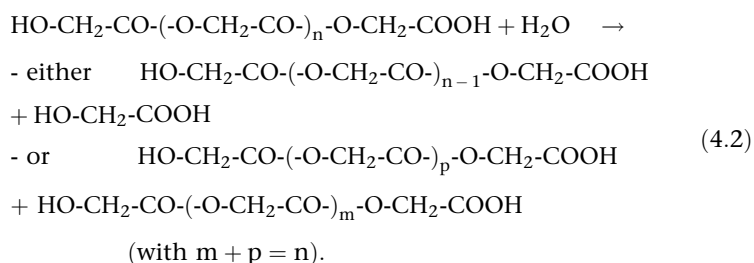
PLA and PLGA have been studied extensively as materials for sutures and later as a basis for polymeric drug carrier systems as micro- and nanoparticles (see Section 4.4.6). To evidence the rate of degradation of PLA, measurements of different parameters have been proposed. It can be seen in the example presented in Figure 4.5 that the weight loss of the material is not very sensitive to degradation. Conversely, degradation is rapidly evidenced by a decrease in the average molecular weight of the polymer and a drop in the mechanical properties of the material.

Crystallinity and water uptake have been shown to be key factors in determining the rate of degradation. As PLLA is the most crystalline and hydrophobic among polylactides, its rate of degradation is the slowest. PLA50 prepared from racemic lactide is also hydrophobic, but it is more amorphous than PLLA and is degraded at a faster rate. However, degradation proceeds faster in amorphous than in crystalline domains of the material. Consequently, the crystallinity of PLA50 increases with degradation, modulating the rate. Finally, degradation of PLGA cannot be extrapolated from degradations of pure PGA and PLAs, as glycolic units are more hydrophilic than lactic units, but more crystalline. Degradation rate of PLGA is maximal for a 50/50 composition of lactic and glycolic units.

The degradation rate also depends on the conditions of preparation of the material, such as quenching and annealing, as such processes can change the crystallinity. Concerning other parameters that are extrinsic to the polymer

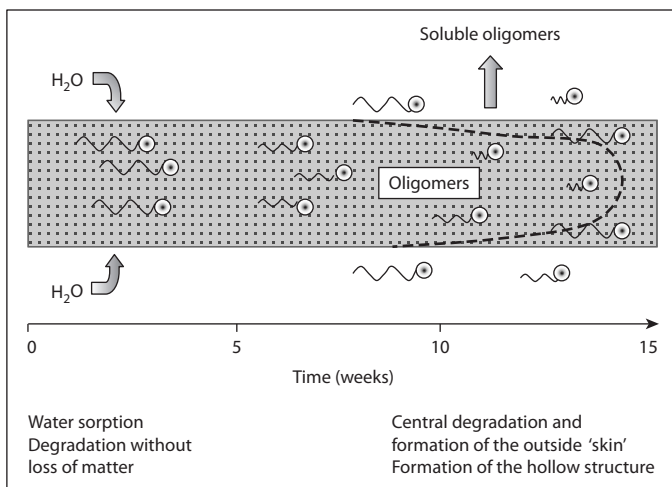
itself, it has been demonstrated clearly that degradation of PLGA does not depend normally on enzymatic activity. However, degradation is faster in the presence of bacteria in infected tissues. Many other factors can influence the degradation rate, including sterilisation processing, storage conditions, external physicochemical parameters in the environment of the material, e.g. pH, ionic strength, applied stress, and adsorption and absorption of different compounds (e.g. solvents, proteins, lipids).

When polylactides were proposed for use in larger devices such as bio-degradable screws and plates for the temporary internal fixation of bone fractures, attention was drawn to some unexpected features concerning the degradation mechanism. It was shown that the size of the object made from polylactides was an important parameter in the degradation, as explained below. Degradation occurs through hydrolysis, and the final product is lactic acid. However, two initial different mechanisms are possible, according to Equation 4.2 concerning PGA.



In other words, scission is susceptible to occur at the end of the chain, resulting in the production of one molecule of glycolic acid and one chain of polymer just short of one repeating unit. Scission can also occur randomly in the chain, resulting in the production of two shorter polymeric chains. By measuring the average molecular weight of the degradation products, it was shown that the real mechanism is the random one.

Concerning the degradation of objects made of PLA, it was expected that the degradation rate would be faster at the surface and independent of the size of the object. However, it was demonstrated that degradation depended on the size of the object and proceeded faster in the bulk than at the surface. This unexpected phenomenon resulted from a fast accumulation of degraded polymeric and oligomeric chains inside the object. Degradation started from the surface in the aqueous medium surrounding the object, but water absorption into the bulk of the material was fairly fast (see Figure 4.5). Thus, degradation took place also in the bulk. At each step of hydrolysis, one carboxylic group was generated and such groups were able to act as catalysts of hydrolysis. The shorter polymeric chains and the oligomers that were generated at the surface of the material were eliminated in the surrounding aqueous medium. Such species generated in the bulk of the material could not diffuse easily in the



**Figure 4.6** Degradation of a large object made of poly(L-L-lactide) (PLLA) by formation of oligomers terminated by a carboxylic group.

polymeric network and remained inside. Owing to the increasing production of carboxylic groups, which were able to catalyse hydrolysis, the rate of degradation was faster in the bulk than at the surface. A hollow structure with an outside 'skin' filled with a honey-like matter was progressively formed, as illustrated in Figure 4.6.

Rupture of the skin resulted in liberation of large amounts of degradation products. As the *in vivo* elimination rate was surpassed, degradation products were concentrated in the surrounding tissues, resulting in an inopportune inflammatory reaction.

For many reasons, new biodegradable polymers were needed and developed following the PLGA family. Poly( $\epsilon$ -caprolactone) (PCL), which is also obtained by ring-opening polymerisation, has the advantage of being softer than PLGA, as its glass transition is well below room temperature; its degradation rate is also slower. Thermomechanical and degradation properties can be modulated by copolymerisation, increasing the possibility of uses of such synthetic biodegradable polyesters.

Polyhydroxyalkanoates (PHA), shown in Table 4.1, are naturally occurring polyesters produced by microorganisms. Poly( $\beta$ -hydroxyacids) such as poly(3-hydroxybutyrate) (P3HB) and its copolymers with 3-hydroxyvalerate [poly(3HB-co-3HV)] were isolated a long time ago. They were developed in the 1980s by ICI under the trade name Biopol<sup>®</sup> for replacing non-biodegradable plastics. Several PHAs are now commercially available and were investigated for biomedical and drug delivery applications. Their degradation rate is generally slower and more gradual than degradation of PLGA. The degradation rate depends on the structure of the polymers and on the sterilisation

process. Because of their bacterial origin, their *in vivo* use in humans has been questioned, but development of purification processes and careful sterilisation has made their use possible.

From a chemical point of view, all of the polyesters presented above have a maximum of two reactive groups per chain, i.e. one at each chain end, which can be modified. Poly(malic acid) and its substituted derivatives were proposed to circumvent this lack of reactive groups. As each repeating unit bears one carboxylic group, it can be modified through many types of reaction. When carboxylic groups are not protected, degradation of the unprotected polymer is expected to be very fast, as carboxylic groups act as catalysts of hydrolysis. A large amount of work is currently being carried out with this family of biodegradable polymers.

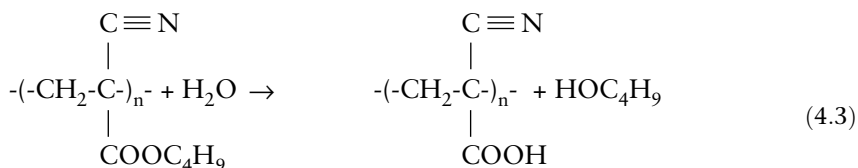
Other types of biodegradable polymer such as poly(ortho esters), poly(organo phosphazenes) and polyanhydrides have been described. However, they have been less developed than polyesters.

Bioerodible polymers represent another possibility of obtaining polymers that can be eliminated through natural ways. Such polymers can be obtained by introducing into the lateral chains of a water-insoluble polymer a bond that can be cleaved *in vivo*, turning the hydrophobic polymer into a water-soluble polymer. Mainly ester bonds have been used. The main characteristic of bioerodible polymers is that the molecular weight remains almost constant during degradation, but solubility is dramatically changed. To avoid accumulation of the degradation products, it is expected that the production rate of the water-soluble polymer could be slower than its elimination rate.

The main family of bioerodible polymers is represented by poly(alkylcyanoacrylate)s (PACA). These polymers have a long history since 1947 as adhesives, especially in areas where a fast cure rate is needed. Polymerisation of alkylcyanoacrylates (ACA) can be initiated in the presence of bases as weak as the hydroxyl ions of water. The propagation rate decreases when the size of the lateral alkyl chain increases. As polymerisation can be very fast, ACAs have been used as surgical glue, as tissue adhesive and for embolisation purposes. As shown in Section 4.4.6, ACAs have also been used extensively for preparing nanospheres and nanocapsules for drug delivery.

Degradation of PACA has been much discussed with regard to possible *in vivo* toxicity. The main chain is not biodegradable, but hydrolytic degradation leading to production of formaldehyde and alkylcyanoacetate is possible, according to the inverse Knoevenagel reaction. This mechanism depends on the pH, temperature and type of PACA; however, the reaction is very slow in physiological conditions when compared with the hydrolysis of the lateral ester, which occurs faster *in vivo*. At physiological pH, the hydrolysis rate depends on the length of the alkyl chain and leads to production of water-soluble poly(cyanoacrylic acid) or its salts and to the corresponding alkyl alcohol, as shown in Equation 4.3 in the case

of poly(butylcyanoacrylate).



Hydrophobic polymer  $\rightarrow$  water soluble polymer + alcohol

This degradation catalysed *in vivo* by various esterases proceeds at the surface, limiting the rate of production of degradation products. Toxicity could result from a rate of production exceeding the rate of elimination. As the shortest alkyl chain degrades the fastest, the alkyl chain of the monomers used *in vivo* is at least equal to or longer than a butyl.

### 4.3 Applications of polymers in biomedical uses

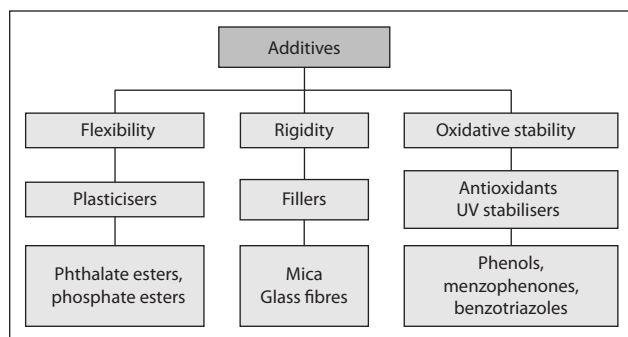
Polymers have been extensively used both as biomaterials, which are constituents of medical devices, and as constituents of drug-delivery systems. Many regulatory requirements must be met in order to use materials in the domain of human health. For instance, sterility is mandatory concerning materials in direct contact with living tissues in the absence of a barrier such as the intact skin. In addition, both polymers and devices have to be biocompatible, and their biocompatibility has to be evaluated by *in vitro* and *in vivo* tests.

However, the regulations differ depending on whether the polymer is a constituent of a medical device or part of a medication. If a drug is included in a medical device for an auxiliary action, then the regulations for medical devices are applicable. If the main action is linked to the presence of the drug, then regulations for medications are applicable.

The aim of this chapter is not to discuss regulatory affairs but to give a rationale for helping one choose the appropriate polymers for a given application. The choice of polymer or another material for making a device or drug-delivery system is directed by the function and the requirements. For instance, the requirement of either elimination or stability of the polymer *in vivo* is a prominent issue. Implanted devices that are supposed to remain functional as long as possible are made from biostable polymers. Injected drug-delivery systems that are administered several times are made from polymers that can be eliminated. In the following sections, some practical examples of existing applications are presented.

#### 4.3.1 Processing and fabrication

In order to be transformed into items such as tubing, catheters and other medical devices, polymers have to be processed by different techniques, such



**Figure 4.7** Schematic view of different additives used to modify the properties of polymers during processing.

as extrusion, moulding, spinning and dip-coating. To facilitate the processing and improve the properties, several additives are used, for instance to increase the stability of polymers during thermomechanical treatments and to modify their properties. A schematic view of additives used during processing is shown in Figure 4.7.

The addition of such products is important in the manufacture of useful items. However, most of these products are small molecules compared with the size of the polymers and therefore some are susceptible to migrating and inducing unwanted reactions in the surrounding living tissues, as explained later.

#### 4.3.2 Sterilisation of polymers

Before contact with the living tissues of animals or humans, polymers and devices have to be sterilised. Even if fabrication is performed in a ‘clean room’, the materials and processing machinery are not sterile. In addition, it has been shown that some bacteria that are normally benign and easily eliminated by the body’s defence systems become pathogenic and drug-resistant when present on the surface of devices.

Current sterilisation processes are generally not well adapted to polymers, except in the cases of water-soluble polymers and colloids, which can be sterilised by filtration in solution. The simplest process is autoclaving with steam at 120 °C for 20 min. This process can be detrimental to devices that include polymers with thermomechanical properties not compatible with the temperature used in the sterilisation process.

Sterilisation by ethylene oxide is very efficient, whatever the shape of the device, as this molecule is very small and reactive. Some drawbacks are linked to these qualities, however. Ethylene oxide can easily penetrate into polymeric networks, and it may react with chemical groups present in some polymers. In the first case, a sufficient degassing time in sterile conditions is necessary



before the device is used in contact with living tissues. In the second case, modifications of the polymer, and especially of its surface, can occur and change the reactions of living tissues in contact with the device.

Sterilisation by high-energy beams, e.g.  $\gamma$  rays or fast electrons beams, is very efficient, as these beams are usually not stopped by materials. However, some covalent bonds of the polymeric network can be broken easily by such a high energy. Depending on the type of polymer and the dose and dose rate of the radiation, permanent chain scission or cross-linking can result from this process, modifying the polymeric structure and properties of the material.

Evaluating the mechanical and surface properties, toxicity and biocompatibility of polymers and devices before and after sterilisation is relevant in order to select for a given polymer or device a sterilisation process that is efficient against bacteria but is as benign as possible for the polymer, the device and the patient.

The drawbacks described above have emphasised the need for new sterilisation processes that are more compatible with polymers. However, these processes are still being evaluated for routine use.

### 4.3.3 Definition and concepts of biocompatibility

Biocompatibility was a vague concept until it was defined during a consensus conference organised in 1986 under the auspices of the European Society for Biomaterials at Chester as follows: 'The ability of a material to perform with an appropriate host response in a specific application.' This means that there is no 'intrinsically biocompatible' material. This precise definition excludes the common use of vague sentences such as 'The device is made from biocompatible materials', which sounds more like advertising copy than a scientific demonstration. The precise definition means that the animal model in which biocompatibility tests have been performed should be specified, as each animal species, including humans, has its own specificities. The application should be specified, as reactions of living tissues surrounding the material depend on many biological parameters and the type of material. A description of the local and systemic reactions should be provided as a function of time, as tissue responses also vary with this parameter.

#### *Biocompatibility and toxicity*

Biocompatibility is not equivalent to non-toxicity. Toxicity, either local or systemic, is related to cell death generally induced by soluble products, whereas biocompatibility is related more to the reactions of living tissues in contact with a solid material. Soluble products can be released by a material. Corrosion of metals and metallic alloys can produce multivalent ions, which are generally toxic. Multivalent ions used for *in vivo* imaging,

e.g. in magnetic resonance imaging (MRI), are carefully chelated in order to avoid toxicity.

It can be deduced from their density that polymeric materials are not as compact as metallic materials. A polymeric material can be thought of as a sponge or a mass of cooked spaghetti, especially when the polymer is amorphous. For this reason, polymeric matrices can load and then release small molecules and can be used as drug-releasing systems. Polymeric materials may also release unwanted soluble products, such as degradation products, residues of monomers, solvents, additives, and ethylene oxide used for sterilisation purposes (see Section 4.3.2). Toxicity of the soluble products can result from lysis of the outer cell membrane, or diffusion into cell organelles. Polycationic polymers, e.g. polylysine, either water-soluble or solid, can be considered as potentially toxic, because they are able to react readily with the negatively charged membrane of cells.

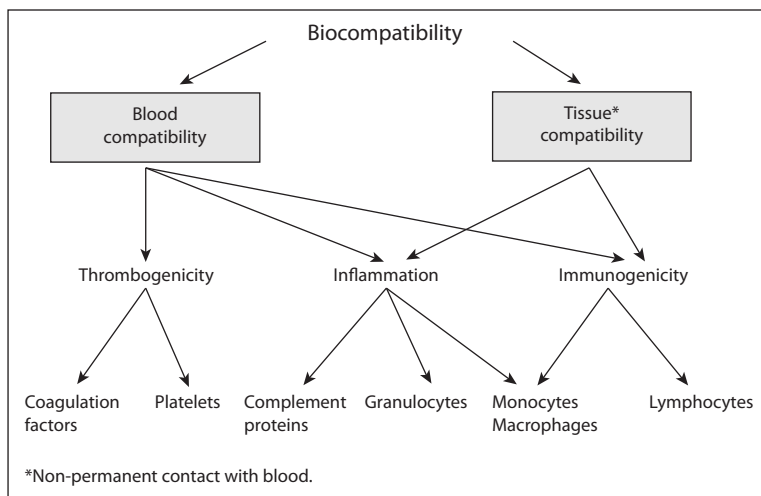
Evaluation of toxicity and biocompatibility is performed in graded test systems starting from general ones, i.e. *in vitro*. Toxicity is usually tested with cell lines growing in the presence of a sufficient amount of the material, and compared with negative and positive controls. Toxicity should be expressed by reference to the weight and surface area of the material. Toxicity of aqueous or lipidic extracts can also be evaluated. When possible, tests of toxicity should be performed with the sterilised material or device, as sterilisation processes can result in the generation of toxic products (see above). Tests of mutagenicity using relevant cells isolated or in living tissue explants in contact with the material can be performed.

When a permanent blood contact is involved in the application, *in vitro* tests such as measurements of haemolysis of erythrocytes or thrombogenicity induced by contact with the material are usually performed. Such tests are not necessary when permanent blood contact is not involved.

If the results of the *in vitro* tests are satisfactory, then *in vivo* tests in small animal models such as mice, rats, guinea pigs or rabbits are performed at different durations with a statistically significant number of animals, including controls. If these results are satisfactory, then the device is tested in large animal models relevant to the application, such as pigs or sheep. Finally, the device is tested in clinical trials. Different procedures for all these tests have been described and normalised.

A toxic material cannot be biocompatible, but contact of a non-toxic solid material with living tissues results inevitably in non-specific and sometimes specific tissue reactions. A schematic presentation of the reactions involved and of some proteins and cells cooperating in these reactions is shown in Figure 4.8.

In order to facilitate the understanding of reactions, two cases have been considered: either (i) there is no permanent contact with blood, expressed as 'tissue compatibility'; or (ii) the contact with blood is permanent, expressed as 'blood compatibility'.



**Figure 4.8** Schematic representation of possible reactions to contact between materials and some proteins and cells involved in the reactions. For the sake of simplicity, water and ions are not included.

### *Tissue compatibility*

In this case, the reactions linked to the permanent presence of blood are excluded, even if a transient contact occurs during surgery. Two types of reaction can occur: inevitably inflammation and sometimes immunogenicity.

### **The unavoidable inflammatory response**

Following the surgical trauma at the insertion of implanted materials, a non-specific tissue reaction inevitably occurs around the inserted material. The aim of the inflammatory reaction is to allow elimination of dead cell debris and further tissue repair. From the point of view of the inflammatory response, a material of optimal biocompatibility should neither add to the basic response in intensity and duration, nor prevent the tissue repair. All of these non-specific reactions occurring on the material's surface involve efficient cooperative processes between ions, proteins and cells.

Histologists have classified the inflammatory and healing processes as a function of the types of cell present around the implant. The **acute inflammatory phase**, normally lasting for a few days, is characterised by the presence of polymorphonuclear neutrophils (PMN). This phase is followed within 2 weeks by the **chronic inflammatory phase**, characterised by the presence of macrophages and lymphocytes. If the material is well tolerated, then this is followed by the **healing process**, characterised by the presence of fibroblasts and the growth of new capillaries, resulting in a thin capsule of fibrosis. If the material is not well tolerated, then inflammation is prolonged, with giant macrophagic cells and development of a thick capsule of fibrosis. Hence, it results that tissue compatibility of materials has to be evaluated at the

different phases, for instance after 2–3 days, after 10–15 days and after 2–3 months of implantation.

### The possible specific response

A specific immune response, i.e. a specific biological reaction to a substance regarded as non-self, is not usually involved during contact with synthetic materials. However, the use of materials from natural origin, such as proteins, polysaccharides, and natural rubber and its derivatives, may induce reactions with pre-existing antibodies or formation of antibodies of different classes against some typical epitopes displayed on the surface of the material.

Two examples of such reactions are given. The first is concerned with natural rubber. Natural rubber latex from *Hevea brasiliensis* has been used for a very long time and the rubber itself should not pose any danger to health. However, natural rubber particles are surrounded by a protective film composed mainly of lipids and proteins. The lipids are similar to the common lipids in the body, but the proteins are quite different and hence are recognised as foreign by the immune system. Frequent exposure to these foreign proteins may cause sensitisation in the user, leading to an allergic response. The rise in the prevalence of latex hypersensitivity in the 1980s was probably due to the increased production of gloves by inexperienced manufacturers, induced by an increased demand coupled to protection against viral problems.

The second example is concerned with regenerated cellulose haemodialysis membranes and is presented in Section 4.3.6.

As shown in the examples above, the presence of antigenic sites can be direct, resulting from the material itself, or from contaminations present on the surface. It can also be indirect, resulting from changes of conformation of proteins adsorbed on the material and becoming antigenic. Thus, immunogenicity of polymeric materials has to be considered as possible, even if the probability is low as far as synthetic polymers are concerned.

### Blood compatibility

Reactions involved in blood compatibility include inflammation and immunogenicity, but the fastest reaction is often thrombogenicity. As blood is a liquid medium, the rate of all reactions is increased as diffusion is much faster in blood than in other tissues, which can be considered as ‘jellified’ media. In addition, blood is usually not static in vivo and some rheological parameters such as type of flow, i.e. laminar or vortex, and shear rate on the surface, strongly modulate reactions of blood. The influence of flow was noted as early as the mid nineteenth century by Virchow in the case of the interactions of blood with blood vessels. In his pioneering work, Virchow showed that interactions between blood and the inside surface of blood vessels depended on the blood itself (normal or pathologic), the flow (continuous or not) and the surface of the vessel (damaged or undamaged). From these early observations,

**Table 4.3** Examples of polymers used in blood-contacting devices

Device	Purpose	Conditions	Polymer used
Blood bags	Storage of blood	Static blood; absence of divalent ions chelated by citrate ions	Any endowed with suitable thermomechanical properties; not expensive (disposable)
Haemodialysers	Replacement of deficient kidneys for blood purification	Flowing blood; anticoagulated with heparin	Flexible polymers for tubing; porous polymeric membranes: modified cellulose, PAN copolymers, polysulfone
Large arterial prostheses	Replacement of deficient large arteries, e.g. aorta or femoral artery	Flowing blood; high shear rate; low ratio of contacted surface/blood volume	Woven or knitted PET for $\varnothing > 6$ mm; expanded PTFE for $\varnothing > 4$ mm
Small arterial prostheses	Replacement of deficient coronary arteries	Flowing blood; high shear rate; high ratio of contacted surface/blood volume	Currently none

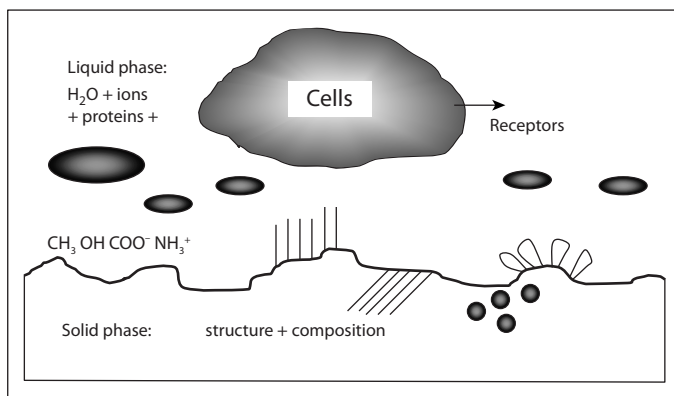
PAN, polyacrylonitrile; PET, poly(ethylene terephthalate); PTFE, poly(tetrafluoroethylene).

it can be deduced that compatibility of blood with the surface of a material is not intrinsic, as it depends on parameters that are independent of the material.

The use of different polymers in contact with blood is shown in Table 4.3. It is clear that some polymers could be considered as ‘blood-compatible’ when used in some conditions of flow but not in others. This is typically exemplified in the case of knitted or woven poly(ethylene terephthalate), e.g. Dacron<sup>®</sup>, which can be used as a constituent of vascular prostheses in humans for replacing arteries larger than 6 mm in diameter but cannot be used for replacing smaller arteries and induces blood coagulation in static blood.

As illustrated in Figure 4.9, the interactions between blood and a material surface depend on the blood and on many parameters determined by the structure and composition of the material. The interactions are modulated both by rheological parameters and by the ratio between the contacted surface area and the volume of the contacting blood.

Concerning blood, reactions depend strongly on the presence of divalent ions (calcium and magnesium), on the presence of many proteins (e.g. factor VIII) and on the presence of platelets mainly in the case of flowing blood. This explains why reactions of blood *in vivo*, i.e. in blood circulating in contact with a material, are difficult to predict from static *in vitro* experiments. Indeed, such experiments are performed in conditions in which coagulation is blocked, for instance in blood plasma depleted in divalent ions or anticoagulated with heparin, or in serum that is devoid of at least fibrinogen.



**Figure 4.9** Model of a blood/material interface. The liquid phase, i.e. static or flowing blood, contains water, ions, proteins and cells. The solid phase is characterised by structural parameters, i.e. size, surface area, rigidity, crystallinity and conformation, and by composition dependent parameters, i.e. types of chemical group, hydrophilicity/hydrophobicity, charge and homogeneity of distribution.

Concerning the surface contacted by the blood, it has been shown for many years that the only blood-compatible surface is the healthy endothelium, which is composed of a monolayer of very active endothelial cells. Concerning all materials, structural parameters (e.g. size, surface area, roughness, rigidity, crystallinity and conformation of molecules on the surface) and also physicochemical parameters (e.g. type of chemical group determining hydrophilic/hydrophobic balance, type of electrical charge, degree of ionisation, ions binding and the existence of micro-domains) have an influence on the interactions between the blood and the surface. Thus, no suitable vascular prosthesis for coronary artery has been found to solve major health problems such as myocardial infarction.

The influence of the size of the material in contact with the blood *in vivo* is a good illustration of the non-specific reactions that permit natural protection against foreign bodies. When submicronic particles, e.g. nanoparticles for drug delivery, are injected in the bloodstream, they are rapidly opsonised, i.e. coated with proteins, and phagocytised. Conversely, if the material is too large to be phagocytised, e.g. microparticles for embolisation, then formation of a thrombus results from contact with the blood. These reactions are generally independent of the material, with a few important exceptions shown in Section 4.4.6. However, the ultimate fate of a material *in vivo* depends strongly on the physicochemical features of its surface.

#### 4.3.4 Polymers for hip and knee prostheses

The hips and knees support the weight of the body and make walking possible. The force applied to these parts can be markedly increased during walking, compared with the weight of the immobile person, especially when the speed

of walking is increased or when playing sport. The bone constituting the original femoral neck supports the changes of applied force with flexibility, as the healthy bone is a living material endowed with the structure of a natural composite material. Walking is possible when the joints can move freely. Free movements of joints are favoured by the presence in the joint of continuously lubricated cartilage.

With progression of osteoporosis, the femoral neck becomes brittle and breaks. Cartilage degraded in some pathologies can become unable to play its role in the joint. In both cases, replacement by a total hip prosthesis is needed. Concerning the femoral neck, materials supporting such applied forces should resist compression and bending. Polymeric composites reinforced by carbon fibres were proposed as materials for such prostheses, as they are light and flexible. However, release of carbon fibres by the prosthesis in the surrounding tissues led to the withdrawal of such materials. Thus, the stems and necks of hip prostheses are presently made of metals, increasingly titanium alloys.

Polymers can be used in the sliding parts of joints. Poly(tetrafluoroethylene) (PTFE) was proposed, thanks to its excellent sliding properties. However, PTFE does not resist friction under compression and is rapidly crushed, leading to loosening of the prosthesis. Ultra-high-density polyethylene is used in the hip when the head of the femoral part is made of stainless steel, and in the joint of the tibia in the knee prosthesis.

Poly(methylmethacrylate) is used to seal prostheses into the bones *in vivo*. As shown in Section 3.4.1, radical polymerisation of methylmethacrylate (MMA) can be initiated at body temperature by decomposition of benzoyl peroxide (BPO) catalysed by dimethyltoluidine (DMT). In a typical example, two vials have been prepared ready for use at the temperature of the operating theatre. The first vial contains MMA and DMT. The second vial contains BPO, micro-beads of PMMA and a radio-opaque agent, e.g.  $ZrO_2$ , to evidence the presence of polymer. Depending on the room temperature, the surgeon has instructions concerning the times for mixing, filling the syringe, injecting the mixture, and maintaining immobilisation of the bone and prosthesis. For instance, at 21 °C, the indicated times are 40 s for mixing, 5 min for filling the syringe and 9–12 min for injection and immobilisation. Thus, sealing such prostheses is a fast process, but the main issue is to avoid too high an increase in temperature in the surrounding living tissues. Indeed, polymerisation is an exothermic process, and the amount of monomer should be limited in order to reduce the emission of heat. To have a sufficient amount of polymer for sealing, the mixture is supplemented with PMMA.

#### 4.3.5 Polymers for breast prostheses

This example has been chosen as typical of the misuse or lack of knowledge of materials used for implantation. As silicones (more precisely, poly(dimethylsiloxane) rubber) are very soft, compliant and rather inert, bags made of

silicone rubber and filled with a liquid or a gel have been used extensively for making breast prostheses. Many serious health problems have occurred, and the use of implanted 'silicones' has led to controversy and lawsuits. The occurrence of anti-silicone antibodies was even claimed in a paper, but fortunately this was not true.

Silicone rubber is very soft and compliant, but this material is rather fragile because its structure is loose, and it can be torn easily if it is too thin. Silicone rubber is also highly hydrophobic. When filled with aqueous liquids, there are no leaks through the wall, whereas oily liquids such as silicone oils can diffuse readily through the wall. In addition, powdery materials such as talc, which may be present on surgical gloves, stick easily to the surface of silicone rubber, inducing strong inflammatory reactions in the tissues surrounding the prosthesis.

When implanted, silicone rubber is slowly calcified and thus rigidified through a mechanism that has not been elucidated. Despite this drawback, there is presently no alternative to the use of silicone rubber, but it should be used only under appropriate conditions, i.e. the bags should be thick enough and filled with aqueous solution, and there should be no talc on the surgical gloves.

#### 4.3.6 Polymers for haemodialysers

Haemodialysers are external assistance devices designed to replace the filtering function of deficient kidneys. A schematic illustration of haemodialysis is shown in Figure 4.10.

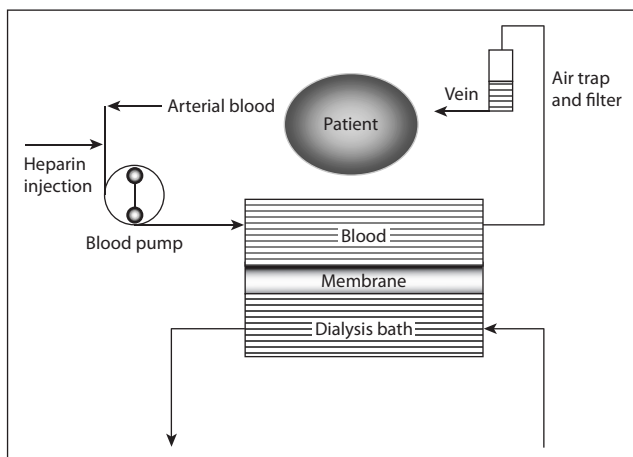
The first haemodialyser was designed by Kolff during the Second World War in the Netherlands. The original idea was to circulate the patient's heparinised blood in a long enough dialysis bag in order to permit:

- exchange of small molecules with a dialysis bath
- elimination of excess water and salt, and of metabolic wastes
- retention of proteins in the blood circuit.

The only type of semi-permeable tubing suitable and available at that time was the cellophane 'skin' used for sausages. Kolff evaluated that a surface area of about 1 m<sup>2</sup> was suitable for an efficient and fast enough dialysis. This same surface area is still the reference for haemodialysis membranes. A mandatory requirement is that albumin should not cross the membrane.

Following Kolff's pioneering work, the design of the circuit was improved and the original cellophane tubing was replaced by flat Cuprophan<sup>®</sup> membranes and then hollow fibres. Despite having good filtering qualities and being of low cost, Cuprophan has been used less and less. Indeed, during haemodialysis sessions with such membranes, it has been shown that problems such as fever and nausea have occurred. In a few cases, life-threatening respiratory distress occurred, even if this was the first dialysis for the patient,



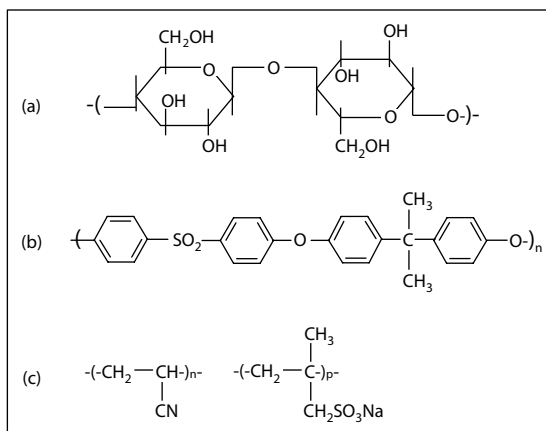


**Figure 4.10** Schematic representation of extracorporeal haemodialysis. Arterial blood is taken from a fistula created in the arm of the patient. After anticoagulation by heparin, blood is pushed into the haemodialyser by a non-haemolytic pump. Blood comes into contact with a semi-permeable membrane (surface area approx.  $1 \text{ m}^2$ ). Water, salts in excess and metabolic wastes are eliminated into the dialysis bath circulating against the bloodstream on the other side of the membrane. The dialysis bath contains ions that can diffuse through the membrane into blood to re-equilibrate the ionic content. After elimination of bubbles and possible clots by filtering, cleaned blood is re-injected into the patient.

the so-called ‘first-use syndrome’. A fast decrease of the circulating neutrophils was observed, resulting from leukocyte activation and sequestration of the aggregates in lungs of the patients. Strong activation of the alternative pathway of complement, resulting in release of inflammatory mediators such as interleukin 1, was associated with the physiological reactions. This occurred in spite of the presence of soluble heparin in the circuit to avoid blood coagulation.

In a model system, it was shown that complement was also activated by contact with cross-linked dextran, i.e. Sephadex<sup>®</sup>. The extent of activation depended on the individual patient, with a factor varying between one and ten in healthy people but being higher in patients undergoing haemodialysis using Cuprophan membranes. For a given individual, the amplification factor in the presence of regenerated cellulose is proportional to the factor evidenced in the presence of Sephadex. Thus, it is thought that a natural antibody able to cross-react with both polysaccharides and to amplify complement activation was present at various levels in certain individuals, inducing strong physiological reactions. The origin of such antibodies is still hypothetical.

To decrease the reactions and the duration of haemodialysis sessions, new types of membrane have been proposed. It has been shown that modifications of the cellulose membrane by substitution of some hydroxyl groups by acetate, or by diethylaminoethyl (DEAE) groups in Hemophan<sup>®</sup>, resulted in



**Figure 4.11** Polymeric materials used in haemodialysis membranes: (a) regenerated cellulose (cellophane, Cuprophan<sup>®</sup>) and modified cellulose derivatives in which some OH groups are modified by binding acetyl or diethylaminoethyl (DEAE) groups (in Hemophan<sup>®</sup>); (b) polysulfone; (c) poly (acrylonitrile-co-methallylsulphonate) copolymers (AN69S<sup>®</sup>).

reduction of complement activation and its physiological consequences. Different synthetic polymeric and more porous membranes, e.g. copolymers of acrylonitrile and methallylsulphonate (AN69S<sup>®</sup>) and polysulfone, have been proposed for haemodialysis and are increasingly used. The polymers used to prepare haemodialysis membranes are presented in Figure 4.11.

#### 4.3.7 Polymers for ophthalmology

The main requirement for polymeric materials used in contact with the eye (contact lenses) or inside the eye (e.g. intraocular lenses) and located on the optical path is isotropic transparency to visible light. Such a requirement has been met by PMMA, which is amorphous. In 1950, Ridley published a study performed in pilots of the British Royal Air Force who had received aeroplane windshield fragments in the eyes. The fragments of PMMA, e.g. Perspex<sup>®</sup>, were generally well tolerated. Thus, for years PMMA has been the polymeric material of choice for meeting both requirements of isotropic transparency and tolerance.

Contact lenses made from PMMA have been manufactured and worn by a large number of people. However, PMMA lenses were not comfortable, patients could use them for only a few hours a day, and the eyes became red at the end of the day. This indicated that the cornea cells suffered because of a lack of oxygen, resulting in the development of small blood vessels in the eye in order to supply oxygen.

These drawbacks were due both to the rigidity of PMMA and to its impermeability to oxygen. As PMMA is very rigid, the radius of curvature of the lens has to be perfectly adapted to that of the eye. In addition, cornea

cells that normally receive oxygen through tears cannot receive oxygen through PMMA. To remedy these drawbacks, manufacturers developed lenses based on acrylic and silicon polymers, which are less rigid and have an increased permeability to oxygen. However, tear proteins and lipids are still adsorbed on these hydrophobic materials.

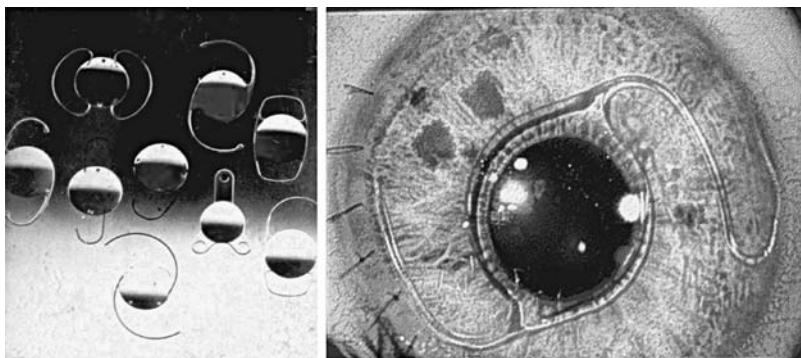
The real breakthrough was the invention at the beginning of the 1960s of hydrophilic soft lenses, by Wichterle in Prague. Made from poly(2-hydroxyethyl methacrylate) (PHEMA), these lenses contained about a third of their weight in water (see Section 2.2.2). They were soft, compliant and permeable to oxygen, making them more comfortable to wear. As they were rather hydrophilic, adsorption of proteins and lipids on their surface was decreased. However, they required careful disinfection, as bacteria could develop in such hydrogels. As the lenses were very fragile and the process of disinfection and rinsing was tedious, long-wear and single-use lenses have now been developed.

Other materials have been proposed, such as silicones, with the advantages of being highly flexible and less fragile than the PHEMA-based lenses, and permeable to oxygen, but with the inconvenience of being highly hydrophobic. Surface treatments have been designed to increase their surface hydrophilicity. Contact lenses are now worn daily by many people, but the instructions for use must be followed carefully in order to avoid severe problems such as abscess of the cornea. No artificial cornea is currently available.

With an ageing population, the occurrence of cataract has increased. This disease results in opacification of the natural crystalline lens. The only way to treat this kind of blindness is to extract the opacified lens and to replace it either externally by very thick glasses, or internally by intraocular lenses (IOLs). PMMA that has been modified by the addition of an ultraviolet-filtering additive to protect the retina has been used to manufacture the optic part of the device.

Some difficulties occurred with maintaining the optic part at the correct place in the eye. Three positions are possible: behind the iris as the natural lens (i.e. posterior chamber), or on the iris or in front of the iris (i.e. anterior chamber). It was shown that the iris was irritated when the IOL was placed on it. Concerning the other positions, the supporting part has to be flexible enough to adapt itself to the size of the patient's eye. As PMMA is a rigid material, the supporting part has been made of a more flexible polymer, e.g. polypropylene, but inflammation occurred at the junction between the polymers. The problems were solved by manufacturing IOLs in one piece of PMMA with long, thin branches in order to obtain sufficient flexibility.

Nowadays, IOLs are mainly composed of PMMA, but some foldable IOLs are in development to facilitate the work of the surgeon and minimise bleeding at the incision, which could contribute to possible inflammation. The only unsolved problem is re-opacification due to cells growing on the surface of the IOL, which needs laser treatment. The reason for this phenomenon is unknown. Some IOLs are shown in Figure 4.12.



**Figure 4.12** Intraocular lenses alone (a) and in the eye (b).

### 4.3.8 Catheters and microparticles for therapeutic embolisation and chemoembolisation

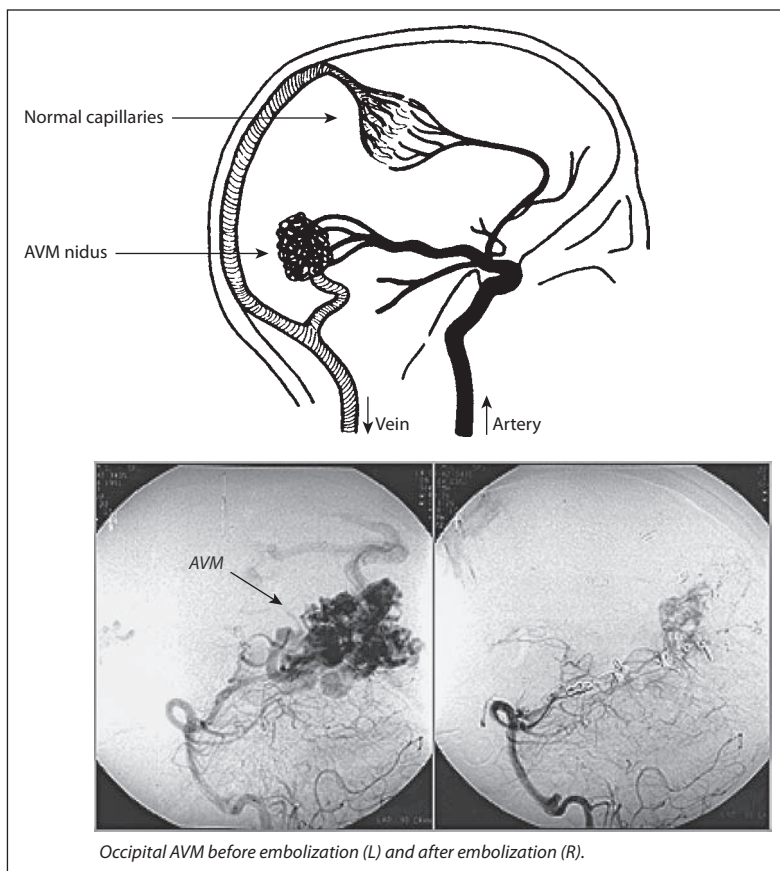
*Dedicated to Pr. A. Jayakrishnan and Dr. A. Laurent.*

Therapeutic embolisation has been a pioneering method within the methods known as interventional radiology and mini-invasive techniques. Such techniques using radiology and catheterisation as tools have the great advantage of avoiding surgery in many cases; for instance, they are currently used to reopen stenosed coronary arteries. The aim of therapeutic embolisation, however, is to obliterate blood vessels supplying blood to a pathological territory, e.g. arteriovenous malformation (AVM), uterine fibroids or other vascularised benign tumours. Embolisation can be used temporarily to occlude a vessel before surgery, or for long-term treatment when surgery cannot be used safely, e.g. in the brain or spinal cord, as shown in Figure 4.13.

Chemo-embolisation has been developed for the treatment of vascularised malignant tumours. Its aim is to combine a local delivery of drug at and around the site of embolisation with a shortage of blood supply. It is currently used mainly in the treatment of hepatic carcinoma.

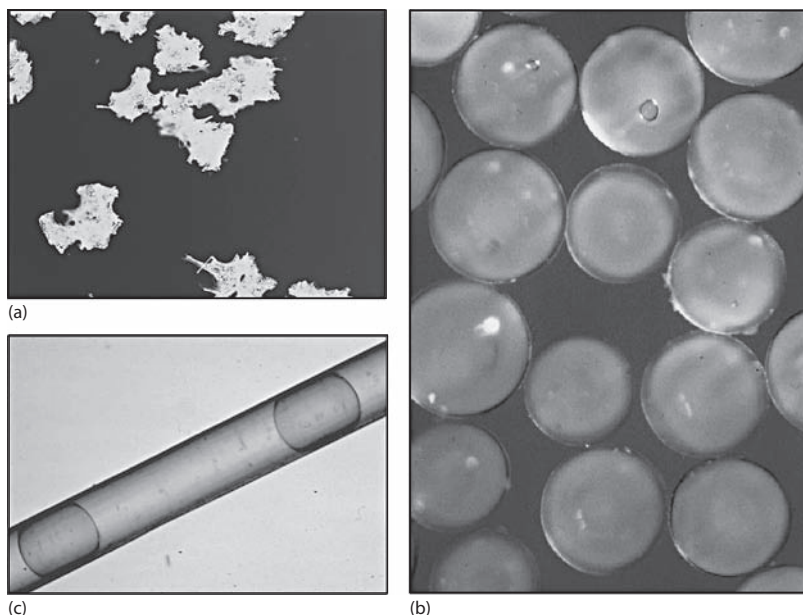
Different devices have been used as tools for embolisation purposes. The vascular system is accessed typically through the femoral system under local anaesthetic. Under systemic heparinisation, a catheter system is advanced with direct visualisation by radiography. Then the vascular system is imaged by injection of an angiographic dye. The images are stored in a computer to serve as reference. Depending on the precise use and on the diameter of the vessels to be occluded, various types of balloon, coil, particle, glue (e.g. PACA) and solutions of jellifying polymers are used. A micro-catheter can be selectively advanced into the vessels and the occlusive material delivered.

Microparticles, i.e. particles with a size usually in the range 50–1000  $\mu\text{m}$ , have been used widely for embolisation of small vessels, and many types of material have been tried. As polymers can be adapted to the many requirements concerning embolisation, polymeric microparticles are mainly used for this purpose. The microparticles should preferably be spherical in order to



**Figure 4.13** Intracranial arteriovenous malformation (AVM) and a radiological view before and after embolisation, visualised by the presence or absence of a contrast agent.

provide optimal occlusion. The size of the spheres should have a narrow distribution in order to control the size of the vessel to be occluded. As the arterial wall is elastic, the sphere diameter should be approximately 1.5 times the diameter of the artery to be occluded. To avoid fractionation of the particles capable of inducing hazardous distal occlusions, the material has to be mechanically stable. The material must be soft, as it is delivered through micro-catheters that are smaller in diameter than the particle; in addition, the material must be elastic enough to recover its initial diameter as soon as possible at the exit of the catheter. To avoid sticking and aggregates forming in the catheters, the surface of the spheres must be smooth and hydrophilic. Finally, the microspheres should not induce a strong inflammatory reaction in the surrounding tissues. An example of such microparticles is presented in Figure 4.14. The efficacy of embolisation is controlled by injection of a contrast agent and comparison with reference images. To make possible in vivo follow-up of the particles, it would be preferable to detect them directly by X-rays or MRI.

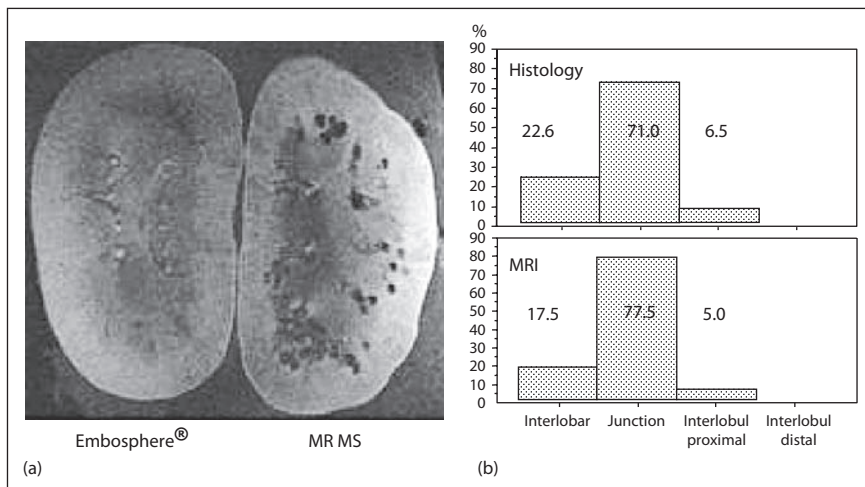


**Figure 4.14** Microparticles for embolisation; clockwise: (a) early PVA particles, (b) soft hydrated microspheres in suspension and (c) soft hydrated microspheres in a catheter.

The most developed particles in the 1980s were based on cross-linked poly(vinyl alcohol) (PVA), e.g. Ivalon<sup>®</sup>. As the particles were not spherical, the main drawbacks resulted either from blockage of catheters, or from too proximal and insufficient embolisation. Spherical particles were developed in order to avoid such drawbacks. They have been made from PVA or from other polymers in different countries: poly(2-hydroxyethyl methacrylate), partially hydrolysed poly(methylmethacrylate) and substituted poly(acrylamides) (Trisacryl<sup>®</sup>). All of these particles are spherical and are made from hydrophilic, non-degradable materials; some are microporous, but others are macroporous. The latter structure was proposed both to add more flexibility to the microspheres and to permit loading with additives such as drugs, gelatin and radio-opaque agents. However, radio-opacity was achieved at the expense of other more useful properties, and such radio-opaque microspheres have not been developed commercially. Microspheres with the required properties and containing a super paramagnetic compound that can be detected by MRI have been developed; an example is given in Figure 4.15.

A high selectivity of the site of embolisation has been achieved by using microspheres with a very narrow size distribution. Such a property has made possible selective embolisation of uterine fibroids without side embolisation of the uterus itself, which would impair pregnancy.

Microparticles made from biodegradable polymers have been proposed for temporary embolisation and for drug-delivery purposes, e.g. chemo-embolisation. The main problem with PLGA-based microparticles is the



**Figure 4.15** (a) Comparison of magnetic resonance imaging (MRI) of kidneys embolised either with normal Embospheres® (left kidney) or microspheres of similar diameter (500–700  $\mu\text{m}$ ) labelled with colloidal superparamagnetic iron oxide (MR MS) (right kidney). (b) Arterial level of occlusion of right kidney evaluated either by histology or by MRI.

inflammatory response that results from the large amount of degradation products, which are released faster than they can be eliminated. An important piece of work has been performed on microspheres based on natural polymers. These pose less toxicity and many are susceptible to biodegradation. However, the presence of antigenic determinants in such polymers is possible. Microspheres made from albumin, casein, gelatin, chitosan, starch, alginate and dextran have been proposed, and review papers are available.

Despite the fact that the presence of microspheres made from non-degradable polymers in pathological arteries induces a generally acceptable inflammatory response, embolisation is not definitive. In fact, revascularisation invariably occurs, excluding this foreign body from the lumen of the vessel at a rate that depends on the material, the animal and the embolised tissue. The molecular mechanisms occurring in this process are unknown.

## 4.4 Applications of polymers in pharmaceutical uses

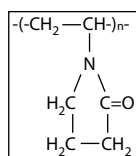
### 4.4.1 Excipients for formulation of conventional dosage forms

Among the various ingredients that are commonly used as excipients in the formulation of dosage forms, polymers are widely used in pharmacy. These polymers are of semi-synthetic or synthetic origin. They are used because of their ability to confer various original functionalities, which can be finely tuned and cannot be achieved using other excipients. It should be noted that, except for parenteral delivery, degradability is not a major concern for most of

these applications. Because of the breadth of the subject, only some examples of applications are given here.

### Excipients for tableting

Formulation of tablets requires the use of various excipients in order to confer a series of functionalities to these conventional dosage forms. A few polymers are currently used as excipients for tablets in various purposes. Cellulose and starch, which can be considered as natural excipients, can be used as diluents when the drug content is low. When tablets have to be prepared by the wet-granulation technique, the addition of a binder is used to agglutinate the powder particles and form grains that are more easily compressed and form strong enough tablets. Common binders include starch used in the form of starch paste, and cellulosic ethers such as carboxymethylcellulose (CMC) and hydroxypropylcellulose (HPC). Alternatively, poly(vinylpyrrolidone) (PVP) (Figure 4.16) in the proportion of a few per cent of the final preparation can be used as a binder.



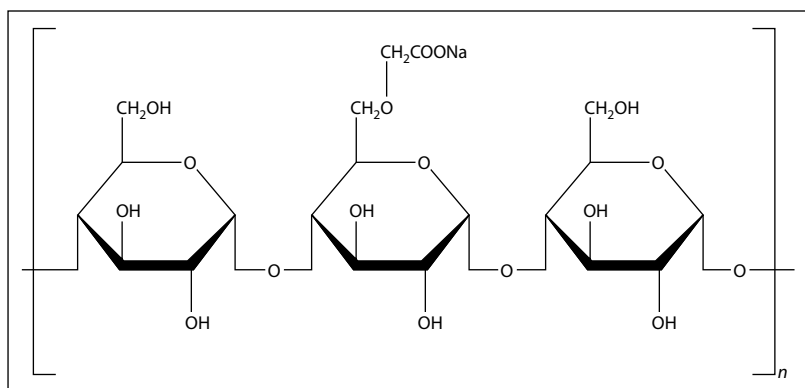
**Figure 4.16** Repeating unit of poly(*N*-vinyl-2 pyrrolidone).

A series of linear homopolymers of vinylpyrrolidone synthetically produced by free radical polymerisation are commercially available. These products have a mean molecular weight ranging from 4000 g/mol to about 1 300 000 g/mol. As this is the case for many commercial brands, these values are only averages and their polydispersity may be rather large. PVP is freely soluble in water and in many solvents, including ethanol, making it an interesting excipient not only as a binder but also in various applications, including as a film-forming material, a thickener and an adhesive agent.

Because conventional tablets need to be rapidly disintegrated in water or gastric fluids in order to allow drug dissolution and absorption, it is generally necessary to add a disintegrating agent in the formulation. Pre-gelatinised starch or chemically modified starch, such as sodium starch glycolate (Figure 4.17) can be used for this purpose. The latter semi-synthetic polymer is called a ‘super-disintegrant’ owing to its capacity to induce fast tablet disintegration when used at levels as low as 2%. Sodium starch glycolate is the sodium salt of a carboxymethyl ether of starch; the molecular weight of commercial brands typically ranges from 500 000 g/mol to 11 000 000 g/mol. It is insoluble in water and most solvents.

Alternatively, purely synthetic polymers such as cross-linked homopolymers of *N*-vinyl-2 pyrrolidone are commercialised under the trade name





**Figure 4.17** General structure of sodium starch glycolate.

Polyplasdone<sup>®</sup>. These polymers are completely insoluble in water, acids, alkalis and all organic solvents. As they are highly hygroscopic and able to swell rapidly in water without forming gels, they are also very efficient disintegrating agents.

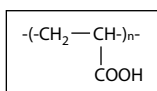
Finally, instead of conventional lubricants, low-molecular-weight (typically a few thousand g/mol) polyethylene glycol (PEG) grades can be used as lubricants in very specific circumstances when water solubility of the whole of the ingredients is required, e.g. in effervescent tablets.

#### *Excipients for semi-solid preparations*

Many semi-solid preparations, such as ointments, creams, gels and toothpastes, lotions, oral suspensions and transdermal gel reservoirs require the use of thickeners or suspending agents. Polymeric excipients have very interesting functionalities for such applications. Hydrophilic polymers are used widely for thickening water solutions or forming gels; semi-synthetic cellulose ethers and synthetic polymers such as carbomers (poly(acrylic acid) derivatives) belong to this category. Carbomers are a good example of a widely used family of such hydrophilic polymers.

Carbomers were first prepared and patented in 1957. Commonly known under their trade name Carbopol<sup>®</sup>, these polymers are composed of homopolymers of acrylic acid loosely cross-linked with polyalkenyl ethers or divinyl glycol. Poly(acrylic acid) homopolymers corresponding to the general structure shown in Figure 4.18 are loosely cross-linked together by various molecules bearing hydroxyl groups, such as sugars or glycol derivatives.

The carboxyl groups provided by the acrylic acid backbone of the polymer are responsible for many of the product's benefits. The molecular weight of



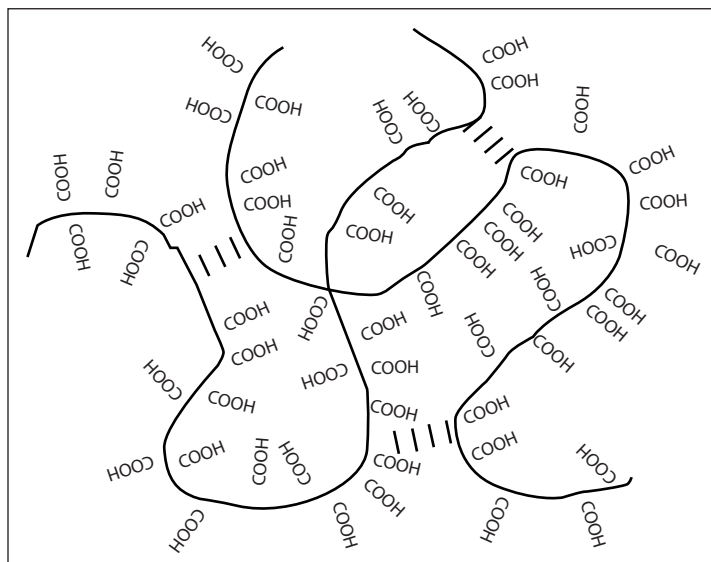
**Figure 4.18** Repeating unit of poly(acrylic acid).

the repeating unit of Carbopol polymers, defined as the moiety containing a single carboxylic group, is considered to be 76 g/mol on average. The calculation of the amount of base requested for neutralising these polymers can be based on this average value.

Commercial grades are available as fluffy white powders consisting of primary polymer particles of about 0.2–6.0  $\mu\text{m}$  average diameter. Due to cross-linking, and once swollen and flocculated, the agglomerates cannot be broken into smaller particles; instead, each particle can be viewed as a network of homopolymeric chains interconnected via cross-linking or entangled together. In the presence of water, the numerous carboxylic groups are hydrated by water molecules, allowing swelling of the polymeric chains (Figure 4.19). Other H-bond-forming substances such as glycerol or diamines can be used for increasing swelling. Alternatively, due to the presence of acidic functions, these polymers can be neutralised by mineral or organic bases.

Because the apparent pKa of carboxylic groups in these polymers ranges from 6.0 to 6.5, the carboxylate groups on the polymer backbone are ionised at physiological pH, resulting in repulsion between charges and increasing swelling of the polymer. Therefore, Carbopol polymers exhibit very good water sorption properties and, depending on the grade, they can swell in water up to 1000 times their original volume at neutral pH. Being water-insoluble polymers, individual powder particles form microgels after hydration, which are biologically fairly inert. Macroscopically, agglutination of these microgels leads to viscous and firm gels in water.

Depending on the nature of the cross-linker, the degree of cross-linking and the manufacturing conditions, various grades of Carbopol are available.



**Figure 4.19** Cross-linked polyacrylic acid polymers (Carbopol®).

The molecular weight of these cross-linked polymers cannot be precisely determined. However, the molecular weights between adjacent cross-links are approximately inversely proportional to the density of the cross-linker. These molecular weights may be calculated from the functionality of the cross-linking monomer, the relative ratio of acrylic acid to cross-linking monomer, and the efficiency of the cross-linking reaction. Therefore, for practical purposes, commercial grades are characterised mainly by the rheological characteristics of the macroscopic dispersions in water. Rheological properties are dependent on the particle size, the molecular weight between cross-links and its distributions, etc., making available an interesting range of commercially available products.

Historically, Carbopol 934 P grade consisted of poly(acrylic acid) homopolymeric chains loosely cross-linked with allyl sucrose and polymerised in benzene. Similarly, Polycarbophil<sup>®</sup> was cross-linked with divinyl glycol and polymerised in benzene. In order to switch to less toxic solvents, other grades were prepared. New grades, such as Carbopol 71G, 971 P and 974 P, are cross-linked with allyl penta-erythritol and polymerised in ethyl acetate. Differences in the process of polymerisation are reflected in the application properties, such as the degree of swelling and the rheological properties of hydrogels, which can vary from one grade to the other.

Being supported by extensive toxicological studies, water-swellaable Carbopol polymers have been used in a wide range of pharmaceutical applications. These polymers are well tolerated, and low toxicities and irritation have been demonstrated. Due to their extremely high molecular weight, they cannot diffuse through epithelia or skin. Specifically, they are used widely as thickeners at very low concentrations in order to produce a wide range of viscosities and flow properties, with high yield values in topical lotions, creams and gels, oral suspensions and transdermal gel reservoirs or suspensions of insoluble drugs in oral suspensions.

Apart from poly(acrylic acid) polymers, other polymers are used widely in the formulation of semi-solid pharmaceutical dosage forms, including natural gums and cellulosic ethers (see Section 4.4.2), PVP and PEG. Different grades of PEG (Macrogol<sup>®</sup>) can be used as thickeners or gelling agents. Interestingly, grades with different molecular weights can be mixed together to adjust exactly the rheological properties of the mixture.

#### **4.4.2 Polymers as excipients for controlled release by the oral route**

The emergence of the concept of controlled-release delivery systems as an effective way to enhance patient compliance and extend the lifecycle of a drug has led to the need for novel ways of controlling drug-release profiles. Polymers offer the opportunity to develop functional excipients able to

efficiently control the release of drugs in a specific location and according to a preset time profile. The use of polymers in pharmaceutical preparations was developed during the 1970s and 1980s, corresponding to a rising need for the minimisation of toxic side-effects and for the lifecycle management of drugs. The basic idea of controlled drug-delivery systems consists of delivering a drug encapsulated in a dosage form accordingly to a preprogrammed amount versus the time profile, conceived in such a way that plasmatic drug levels or organ drug levels can be maintained in a therapeutic window defined by the minimal effective concentration and the maximal tolerated concentration. This strategy has led to a reduction of plasmatic drug peaks and valleys typically associated with immediate-release dosage forms, which is not only beneficial for the patient but also interesting in reducing health costs.

Controlled-release delivery systems can be categorised into matrix or reservoir delivery systems. Such delivery systems are based on natural or synthetic polymers. Matrix systems consist of microscopic or macroscopic polymeric materials in which a drug is dispersed either in a molecular state or as crystalline particles. Delivery of the therapeutic agent can occur via diffusion or erosion of the bulk material. In reservoir systems the drug is placed in the so-called reservoir, which can be semi-solid or solid and is surrounded by an external membrane that controls outside diffusion of the drug and therefore the release profile. The general organisation of controlled-release delivery systems and the type of polymer to be used is influenced strongly by the route of administration.

Delivery systems for oral delivery are typically based on natural polymers or their derivatives, e.g. cellulose and cellulose ethers, as well as on hydrophilic synthetic non-degradable polymers, e.g. poly(vinyl pyrrolidone) and poly(alkylmethacrylates). Development of new applications in this area has mostly been based on the finding of optimal formulations by selecting or mixing adequate commercial grade polymers, and on the development of original fabrication processes of solid dosage form, rather than on the design of novel polymers. However, the use of polymers for parenteral applications, including injection or implants, is relatively new and is an active research field in the search for innovative polymers.

The aim of this section is to give a broad overview of the polymers that have been commonly used in controlled delivery by the oral route but not to develop the rationale underlying the formulation of these types of systems. The development of matrix or reservoir systems is based on the properties of the materials themselves, e.g. their swelling, diffusion and barrier properties, and suitable polymers must be chosen for the specific properties of the materials they form, e.g. tablets, microgranules and films, in the presence of physiological fluids. Commonly used polymers in this area are presented according to this classification.

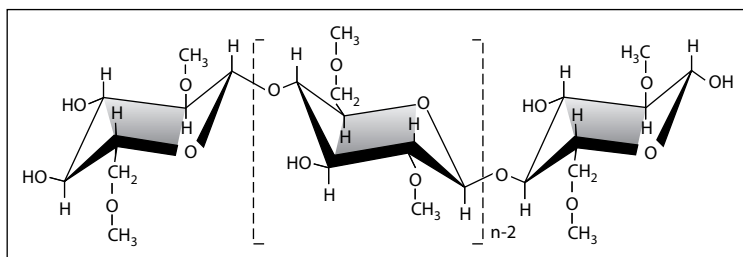
### Hydrophilic polymers for matrices formulation

Matrix systems provide controlled release of the drug via diffusion or erosion mechanisms. Insoluble polymers such as polyethylene or poly(alkylmethacrylates) can be used. In such cases, matrices are formed by tableting or hot melt extrusion processes, in which the drug to be released is generally dispersed as a powder. Because of the inertness of these matrices in contact with gastrointestinal fluids, drug release is governed mainly by diffusion, while the matrices remain almost intact during intestinal transit. However, much more commonly, controlled release is achieved by using water-soluble polymers that encapsulate the active ingredient in specific patterns (e.g. layers, cores, three-dimensional structures). The release of the active ingredient over time can be controlled mainly by diffusion. Typically, the matrix is swollen by water, which then dissolves the solid-state drug contained in the matrix, resulting in a further progressive diffusion through the swollen network. Alternatively, polymer can be dissolved in the gastrointestinal tract, leading to progressive erosion of the matrix and progressive release of the active ingredient. The rate of release can be adjusted by mixing or layering hydrophilic polymers with varying swelling/dissolution kinetics and by the use of innovative fabrication designs.

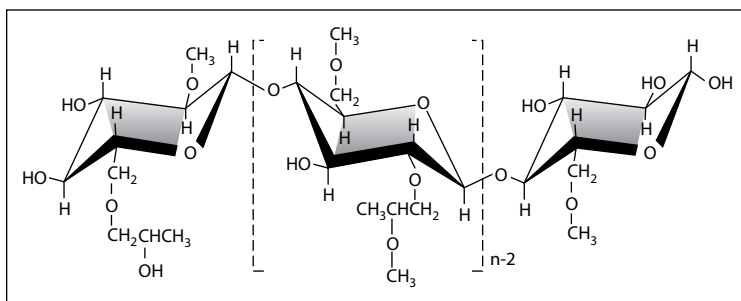
For common applications, polymers for controlling oral delivery are non-absorbable due to their high molecular weight and their hydrophilicity, making useless the use of degradable polymers from a toxicological standpoint. Thus, cellulose derivatives or hydrophilic gums are commonly used, especially methylcellulose (MC) (Figure 4.20) and hydroxypropylmethylcellulose (HPMC) (Figure 4.21).

Cellulose ethers have the polymeric backbone of cellulose, a natural carbohydrate that contains a basic repeating structure of anhydroglucose units. During the manufacture of cellulose ethers, cellulose fibres are treated with caustic solution, which in turn is treated with methyl chloride or propylene oxide. The chemical reaction yields a fibrous product, which is purified and ground to a fine powder. Commercial grades vary chemically and physically for matching the desired applicative properties.

The major chemical differences are in the degree of methyl substitution, hydroxypropyl substitution and polymerisation of the cellulosic backbone.



**Figure 4.20** General structure of methylcellulose.



**Figure 4.21** General structure of hydroxypropyl methylcellulose.

Although the molecular weights and polydispersity of these products can be determined, e.g. by intrinsic viscosity determinations, these data are generally unknown and commercial grades are characterised indirectly by the viscosities of 2% solutions of the polymer in water. These products possess varying ratios of hydroxypropyl and methyl substitution, a factor that influences properties such as organic solubility and the thermal gelation temperature of aqueous solutions. As an example, the percentages of methyl groups and hydroxypropyl groups in the K HPMC grades commonly used for matrices formulation are 19–24% and 7–12%, respectively. For more detailed information, the reader is referred to the technical bulletins of the commercial producers.

Apart from these widely used products, other cellulosic ethers such as HPC, hydroxyethylcellulose and CMC are often used in the formulation of controlled pharmaceutical delivery systems.

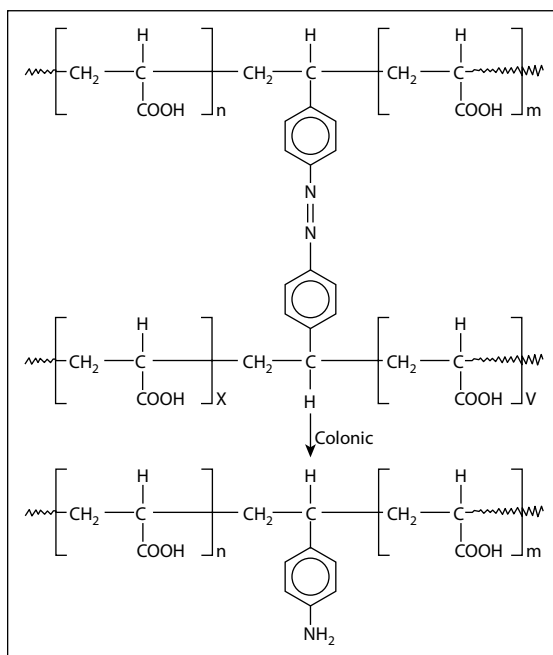
#### *Controlled release in specific regions of the gastrointestinal tract*

Specific polymers have been designed to release drugs into specific regions of the gastrointestinal tract. For this purpose, methacrylic polymers with pH-dependent solubility have been used widely. As described above, commercial-grade polymers characterised by their solubility at different pH can be used to adjust the level of delivery in the intestine. Further, azopolymers have been developed to target the colon, which is of great interest for the local treatment of inflammatory diseases and colitis. An example of azopolymer is presented in Figure 4.22.

The diazoic bond is stable in the gastrointestinal fluids, except in the colonic environment because of the presence of colonic bacterial flora, which produce enzymes able to cleave such bonds. Such polymers can be used to form matrices or coatings that are progressively eroded, allowing localised release of the drug.

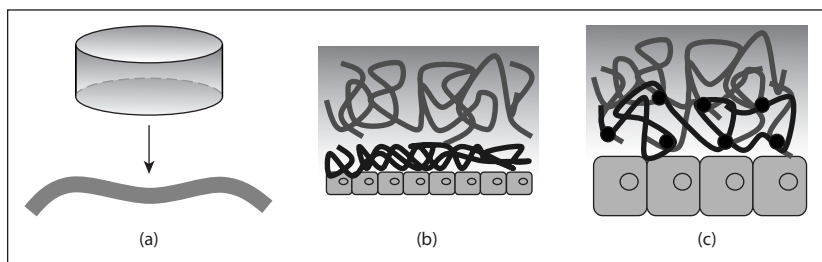
#### *Bioadhesive polymers for mucosal delivery*

Following administration, bioadhesive dosage forms are intended to adhere at the surface of a mucosa, either to prolong the duration of activity of a drug locally or to enhance the permeation of the drug and thus enhance its systemic



**Figure 4.22** Example of azopolymer (after Kakoulides EP et al., *J Control Rel*, 52: 291–300, 1998). (with permission).

availability. Moreover, efficient protective effects against degrading conditions prevailing in physiological fluids, e.g. pH and enzymatic activity, can be obtained by incorporating the drug into such dosage forms. Many routes of administration can benefit from bioadhesive dosage forms, including the oral, buccal, vaginal, ocular, nasal and pulmonary routes. Bioadhesive or mucoadhesive properties can be conferred to various dosage forms, using specific polymers able to interact efficiently with mucosal surfaces. Because of the hydrophilic nature of this substrate and the ubiquitous presence of fluids on these surfaces, commonly used polymers should be able to form hydrogels in contact with mucosal surfaces. Usually, dosage forms such as tablets and microspheres are intended to be administered in a dry state. When placed in contact with a mucosal surface, a hydrogel is rapidly formed. Then, polymeric chains encounter the mucosal surface, which is lined with a mucous layer formed by a very large network of glycoproteins that creates a kind of ‘natural’ hydrogel. In the first stage of contact, the jellifying dosage form should wet this surface. Further, diffusion of the polymeric chains into the glycoprotein network is expected, increasing the possibility of interactions at the molecular state. Simultaneously, the polymeric chains should be able to develop molecular interactions with specific chemical groups belonging to the mucosal substrate. Various interactions can be developed at the interface, including electronic interactions and H-bonding, as shown in Figure 4.23.

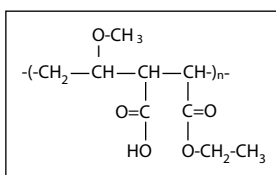


**Figure 4.23** Schematic events following bioadhesion of a matrix tablet at a mucosal surface: (a) initial contact of the dry polymeric matrix with the mucosal surface; (b) polymeric chains are progressively hydrated at the matrix surface and in contact with the mucous layer lining the mucosa; (c) progressive chain interdiffusion between bioadhesive polymer chains and mucous glycoproteins encourages intimate contact and favours development of adhesive interactions, schematically depicted as black spots at the molecular level.

The strength of the interaction depends simultaneously on the interfacial behaviour of the polymeric chains and the rheological properties of the hydrogel, making the molecular properties of the polymers key parameters for optimised bioadhesion. Not surprisingly, hydrophilic polymers represent good candidates for such applications. Polymers containing carboxylic groups, such as poly(acrylic acid) and poly(methyl vinyl ether-co-maleic anhydride) (PVM/MA; Gantrez<sup>®</sup> AN), shown in Figure 4.24, exhibit excellent mucoadhesive properties, but other neutral polymers, including PVP, PVA and cellulosic ethers such as MC, HPMC, sodium CMC, HPC and other cellulose derivatives, can also be used as efficient ingredients for the formulation of bioadhesive dosage forms.

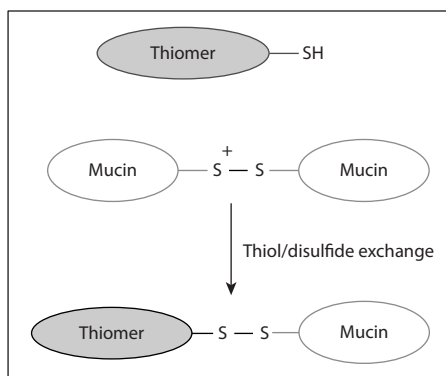
Alternatively, cationic polymers such as chitosan and chemically modified chitosan can be used because of their capacity to interact strongly with anionic electric charges borne by glycoproteins in the mucous layer.

Important factors of adhesion are the chain linearity, chain flexibility and molecular weight of the polymer, which should be high enough (up to millions) for facilitating chain interdiffusion at the interface and also formation of highly viscous hydrogels. The presence, density and spatial availability of chemical groups able to interact by forming with substrate and under the physiological conditions are equally important parameters.



**Figure 4.24** Chemical structure of poly(methyl vinyl ether-co-maleic anhydride) (PVM/MA, or Gantrez<sup>®</sup> AN).





**Figure 4.25** Schematic representation of mucoadhesive interactions of thiomers with mucin glycoproteins.

Further, the rheological properties of the bulk hydrogel are important, as the strength of mucoadhesion depends partly on these properties. From this point of view, formulation is of importance in order to obtain rheological synergies favourable to adhesion, which can be obtained by polymer blending, e.g. two cellulosic ethers or two grades of a single cellulosic.

Based on this, advanced polymers have been designed more specifically to improve mucoadhesive applications. For example, thiomers are thiolated polymers constructed by grafting thiol groups on a hydrophilic polymer. The presence of thiomers makes possible formation of disulfide bridges between the natural mucins, which are rich in thiolated amino acids and the thiomers, thus reinforcing adhesion, as shown in Figure 4.25. Additionally, such polymers have been shown to exhibit antiprotease activities, which are expected to be useful for enhancing peptide delivery.

Alternatively, acid-based polyanhydrides such as poly(fumaric anhydrides) and poly(maleic anhydrides) have raised interest because of the capacity of anhydrides to progressively hydrolyse in the presence of physiological fluids, leading to the production of high amounts of carboxylic groups on the surface of the dosage form, which have been shown to enhance bioadhesiveness of the matrix, thus increasing its residence time at the mucosal surfaces.

Finally, it should be mentioned that many attempts have been proposed to enhance adhesion by grafting adequate ligands at the surface of the polymeric matrices, either made of inert or degradable polymers. Indeed, when matrices are in the form of micro- or nanoparticles, specific ligands able to recognise specific receptors at the mucosal surface can be presented at the surface of the delivery device. The rationale for such an approach is to simultaneously increase the intensity and the duration of adhesion and to localise the adhesion on mucosal areas bearing specific receptors.

### 4.4.3 Polymers for coating applications

In pharmacy, polymeric film coating is currently applied to various dosage forms, including tablets, pellets and microgranules, for decorative, protective and functional purposes. These coatings can be used to protect the active ingredient against exposure to environmental factors. Very often, for safety and marketing reasons, it is necessary to improve the appearance and enhance the mechanical strength of the dosage form, in particular for many tablets. Tablets may be coated in order to give a glossy, coloured finish, which may also be printed with the trade name for safety reasons. Finally, polymer coating is one among many technologies employed to modify the release of oral solid dosage forms. One such method is the use of insoluble or semi-permeable polymer films to surround the dosage form and alter drug release.

Whatever the application, polymers for coating can be used either as solutions in organic solvents such as ethanol or hydroethanolic mixtures, or as water dispersions. For technological simplicity and to minimise the amount of residual solvents in the final products, the latter technique is of interest and is far more developed. Thus, polymers for coating are generally commercially available as preformulated water dispersions, sometimes including plasticisers, colorants and opacifiers. However, powders are also available, which have to be further treated before being used for coating. Film coating is achieved by a spray atomisation technique using coating pans or turbines, in which polymer-containing solutions or dispersions are atomised with air and delivered to the substrate surface as fine droplets. These droplets spread on the surface; solvent evaporation causes the droplets to pack closely and to coalesce to form the film. Finally, polymer chains may entangle to some extent. Thus, the final properties of polymer films depend not only on the physicochemical characteristics of the polymers but also on the coating formulation employed, the substrate variables and the processing conditions.

Important properties of coatings include solubility/insolubility in physiological fluids, drug diffusibility through water-insoluble films, water vapour and oxygen permeability, and thermal, mechanical and adhesive characteristics. These characteristics can be evaluated either directly on isolated films or indirectly after deposition on the considered dosage forms.

#### *Polymer and film solubility/insolubility in physiological fluids*

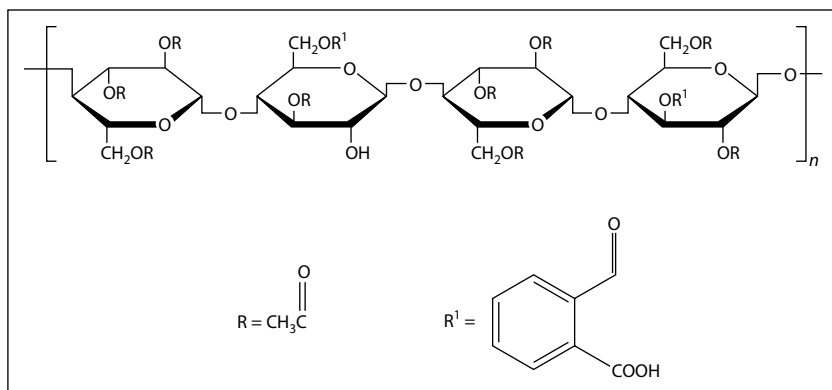
Depending on the application, a variety of polymers with varying solubility in physiological fluids are available. Some currently used polymers and their solubility and ordinary uses in formulation are presented in Table 4.4. When coatings are requested, for example to improve the external aspect or to enable easy swallowing of tablets, fast-dissolving films are needed. Commonly, low-molecular-weight grades of cellulosic ethers such as HPMC are used for this purpose. These polymers are water-soluble and

**Table 4.4** Polymers used for coating applications

Polymer	Solubility	Common use	Usual presentation
Ethyl cellulose	Insoluble in water, regardless of pH; soluble in some organic solvents	Controlled-release coatings	Aqueous dispersions (20–30% solids)
Cellulose acetate phthalate	pH-dependent solubility in water; soluble in alcohols, hydrocarbons and some ketones	Enteric coating	Used either as aqueous dispersion (30% solids) or in solvent-based coatings
Hydroxypropylmethylcellulose phthalate	pH-dependent solubility in water	Enteric coating	
Poly(methyl methacrylate) copolymers, e.g. Eudragits®	Insoluble or pH-dependent solubility; soluble in solvents	Controlled release and enteric coating	Powders or aqueous dispersions
Hydroxypropylmethylcellulose (HPMC)	Soluble in water	Masking taste; moisture barrier for immediate-release dosage forms	Mostly sold as preprepared formulations, including plasticisers and colourants
Methylcellulose	Soluble in water; very low viscosity	Tablet and pellet coating	Powder or as preprepared formulations, including plasticisers and colourants
Hydroxypropylcellulose (HPC), e.g. Klucel®	Soluble in water	Tablet or pellet coating combined with other cellulosic ethers	Powder
Hydroxypropylethylcellulose (HPEC)	Soluble in water	Tablet or pellet coating	Powder

non-ionised, making their films easily dissolved following administration of the dosage form and contact with gastric or intestinal fluids.

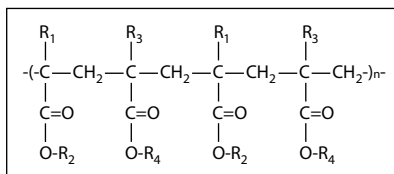
Enteric coatings, i.e. coatings that are insoluble at the acidic pH encountered in the stomach but are readily soluble at intestinal pH, can be achieved using polymers bearing carboxylic groups. Because of their pH-dependent solubility, some cellulosic derivatives, e.g. cellulose acetate phthalate (Figure 4.26), can be used for such applications.



**Figure 4.26** General structure of cellulose acetate phthalate.

Alternatively poly(alkylmethacrylates) have been tailored for this purpose. Eudragit<sup>®</sup> L and S are anionic copolymers of methacrylic acid and methylmethacrylate that are water-soluble only above gastric pH, making it possible to mask and protect the dosage form during gastric transit and to unmask the dosage form at intestinal pH. By varying the ratio of monomers, it is possible to accurately tune the pH of dissolution of these copolymers in such a way that drug delivery can be triggered at a specific level along the gastrointestinal tract, depending on the physiological pH prevailing at the considered level. Some types of Eudragit are shown in Figure 4.27 and discussed in Tables 4.5 and 4.6.

Finally, insoluble polymers can be used for controlled-release applications, regardless of the pH. Ethyl cellulose or different Eudragit grades corresponding to copolymers of acrylate and methacrylate bearing no ionisable groups can be used for forming insoluble films at the surface of microgranules, or other dosage forms, and with varying permeability to the drug contained into the dosage form.



**Figure 4.27** General structures of Eudragit<sup>®</sup>. Variations are given in Table 4.6.

### Water vapour permeability

Water vapour permeability can be measured to determine the effectiveness of a film coating to act as a barrier to water. Several variables have been shown to influence water vapour permeability, and considerable variations can be observed when modifying the film composition, film thickness and film preparation technique. By using different experimental setups, it is possible to measure the water vapour transmission rate (WVTR, generally expressed in  $\text{g}/\text{m}^2/\text{day}$ ) of

**Table 4.5 Eudragit®: a series of methacrylate-based coating materials with a variety of functional properties**

Polymer characteristics	Commercial grades, pH of dissolution and applications
Anionic copolymers of methacrylic acid and alkyl methacrylates with available –COOH groups	Eudragit L 100-55 (powder), soluble above pH 5.5
	Eudragit L 30 D-55 (aqueous dispersion), soluble above pH 5.5 (delivery in upper intestine)
	Eudragit L 100 (powder) soluble above pH 6.0 (delivery in jejunum)
	Eudragit S 100 (powder), soluble above pH 7.0 (delivery in ileum)
	Eudragit FS 30D (aqueous dispersion), soluble above pH 7.0 (delivery in ileum), requires no plasticiser
Cationic copolymer bearing dimethylaminoethyl ammonium groups	Eudragit E 100 (powder or granules), soluble in water up to pH 5.0, swellable and permeable above pH 5.0
Cationic copolymers of acrylate and methacrylates bearing quarternary ammonium groups	Eudragit RL 30D (aqueous dispersion), insoluble and pH-independent polymer for sustained-release formulations, high-permeability films
	Eudragit RL PO (powder), insoluble and pH-independent polymer for sustained-release formulations, high-permeability films
	Eudragit RL 100 (granules), insoluble and pH-independent polymer for sustained-release formulations, high-permeability films
	Eudragit RS 30D (aqueous dispersion), insoluble and pH-independent polymer for sustained-release formulations, low-permeability films
	Eudragit RS PO (powder), insoluble and pH-independent polymer for sustained-release formulations, high-permeability films
	Eudragit RS 100 (granules), insoluble and pH-independent polymer for sustained-release formulations, high-permeability films

isolated or coated films. This latter method is especially useful for investigating the influence of excipients in the tablet core on water vapour permeability.

### *Oxygen permeability*

Oxygen permeability is a measure of the effectiveness of the coating material to act as a barrier to oxygen and is especially important when working with active pharmaceutical ingredients that can be degraded by oxidative

**Table 4.6** Composition of main Eudragit<sup>®</sup> grades, accordingly to the formula presented in Figure 4.27

Eudragit grade	Composition
Type E	R1, R3 = methyl
	R2 = dimethylaminoethyl
	R4 = methyl, butyl
Type L	R1, R3 = methyl
	R2 = H (50% methacrylic acid)
	R4 = methyl
Type S	R1, R3 = methyl
	R2 = H (30% methacrylic acid)
	R4 = methyl
Type RL	R1, R3 = methyl
	R2 = methyl, ethyl
	R4 = trimethylammoniummethacrylate (10%)
Type RS	R1, R3 = methyl
	R2 = methyl, ethyl
	R4 = trimethylammoniummethacrylate (5%)
Type E 30D	R1, R3 = H, methyl
	R2, R4 = methyl, ethyl
Type L 30D	R1, R3 = H, methyl
	R2 = H (50% methacrylic acid)
	R4 = methyl, ethyl

processes. Film composition and film thickness have been shown to significantly influence oxygen transmission. This parameter is determined more easily on isolated films using similar techniques as for water vapour permeability, although it is possible with coated dosage forms. Deposition of a light HPMC-based coating used to produce a high gloss and pearlescent appearance in tablets is enough to slow down the rate of oxygen permeation through an applied film compared with uncoated tablets.

Various methodologies for determining the permeability of materials or polymeric films to water vapour or oxygen have been described. The reader is referred to the references given at the end of the chapter.

### *Thermal properties*

The glass transition temperature ( $T_g$ ) is an important polymer property that is closely related to the mechanical properties of the polymer films. The  $T_g$  is the temperature at which the mechanical properties of a polymer change from a brittle to a rubbery state (see Section 2.3.3). Film coatings need to be simultaneously strong enough and highly flexible in order to remain intact on rough surfaces or when dosage forms such as tablets present angular profiles. There have been numerous studies on  $T_g$  to evaluate polymer properties, polymer miscibility and long-term interactions with excipients. The introduction of plasticisers mixed with the polymer is a common strategy to decrease  $T_g$  and make the film less brittle. Dynamic mechanical analysis (DMA) is another type of test that can be used to study the relationship between  $T_g$  and the mechanical properties of the film.

Another interesting parameter is the minimum film-forming temperature (MFFT), which is the minimum temperature at which a polymeric material is able to coalesce to form a film. At temperatures below MFFT, a white opaque or powdery material is formed, whereas a clear, transparent film is formed at temperatures equal to or greater than MFFT. The MFFT has implications in coating processes. The temperature in the mass during coating must be above the MFFT in order to ensure film formation.

### *Mechanical testing*

Polymer films must be mechanically strong enough such that they do not break or fracture during processing, packaging, shipping or storage. Prediction of these properties is not an easy task, since commonly used experimental techniques such as tensile testing, which are used to assess the mechanical strength of polymer coatings, are performed more easily on isolated films than on deposited films. Alternatively, compression or puncture testing can be carried out directly on the films borne by their substrate.

Adhesion between the polymeric film and substrate is a major concern. Poor adhesion could result in flaking or peeling of the coating from the substrate core. Moisture could accumulate at the film–substrate interface and compromise the mechanical protection provided by the coating. Polymer adhesion is related to both film–substrate interfacial interactions and internal stresses within the film. Polymer adhesion can be evaluated by peel tests or butt joint tests. Apart from the specific properties of the polymers, excipients used in tablet formulations can influence film–tablet adhesion. Since adhesion between a polymer and the tablet surface is due primarily to hydrogen bond formation, hydrophobic agents may decrease adhesion by

presenting a surface consisting of mainly apolar hydrocarbon groups, which depends on the nature and concentration of the excipient.

### *Polymer coatings and drug interactions*

For many pharmaceutical applications, polymeric coatings and most dosage forms are water-soluble. During application of the coating layers on the substrate, dissolution of the outermost surfaces of the substrate can occur quite easily, resulting in mixing and migration of the drug or excipient into the coating film. This phenomenon can affect the mechanical, adhesive and drug-release properties of the polymer film. Similar migrations can occur during the shelf life of the products, even in the presence of very low amounts of water and regardless of the water solubility of the polymeric coating. This negative effect can often be limited by depositing a preventive HPMC sub-coating as a sandwich layer between the drug-containing dosage form and the functional polymeric coating.

#### **4.4.4 Adhesive polymers for skin delivery**

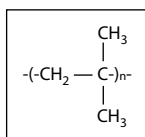
The domain of medical adhesives is broad and can be divided into different categories, including structural adhesives for assembly of medical devices, tissue adhesives (e.g. surgical glues) and pressure-sensitive adhesives (PSAs), mostly designed to adhere at the surface of the skin. Typical applications for PSAs in the healthcare industry include wound coverings and closures, surgical drapes, ostomy (i.e. a surgically created opening in the body for the discharge of body wastes) mounts and pouches, electrocardiograph electrode mounts, electrosurgical grounding pads, and transdermal drug delivery systems.

### *Adhesion to skin*

Skin is a very demanding and variable substrate for adhesive bonding. Various applications are based on the use of PSAs. The minimal requirements for PSAs are (i) to adhere easily to varying skin types for a prolonged period of time, (ii) to be removable without leaving adhesive residue or causing skin damage and pain and (iii) to be not irritating to the skin.

Skin is a rough surface, requiring PSAs to have the capacity to spread and to flow easily. For this reason, PSAs should have a  $T_g$  or softening temperatures ranging from  $-20\text{ }^\circ\text{C}$  to  $-60\text{ }^\circ\text{C}$ , meaning that these materials are soft materials at skin temperature. Once the PSA has spread at the surface of the skin, optimal adhesion is dictated by two main properties: the surface energy of the PSA–skin, and the bulk rheological properties of the adhesive polymer. Formulation of PSAs for skin applications is rather difficult since it requires good, prolonged adhesion at the skin surface and simultaneously easy removal with minimal trauma, regardless of the duration of application.





**Figure 4.28** Repeating unit of poly(isobutylene).

The surface energy of the adhesive has to be lower than that of skin. The surface energy of the skin is dependent on temperature, relative humidity due to transepithelial water loss (TEWL), sudation and sebum secretion. It is in the range 40–60 mJ/m<sup>2</sup>; that of the non-polar components under normal conditions is higher than that of the polar components. For the sake of comparison, acrylic medical-grade PSAs may have surface energies in the range 25–30 mJ/m<sup>2</sup>.

Adhesion results from the combination of an adequate surface energy couple between the PSA and skin and rheological properties. Adhesion is commonly measured by a peeling test, which involves the measurement of the force required to peel an adhesive, spread on to a flexible backing, from a substrate whose surface properties are well characterised.

#### *Polymers used in the formulation of medical grade PSAs*

Natural rubber and poly(isobutylene) (Figure 4.28) were the earliest polymers used for formulating medical PSAs due to their high peel strength, elongation and ease of acceptance by skin tissue.

Poly(isobutylene) has a low  $T_g$ , producing naturally flexible materials that are naturally tacky masses. Poly(isobutylene) (molecular weight 80 000–100 000) such as Vistanex™ are used for the preparation of medical tape. This polymer needs to be tackified, which can be achieved by mixing with polybutyl rubber or other low-molecular-weight poly(isobutylene) or mineral oils. However, for more demanding applications, these are now largely replaced with modern, synthetic polymers, which are used in the formulation of medical-grade PSAs, depending on the applications, as described in Table 4.7.

Acrylic polymers are used widely due to their wide tailoring possibilities and their low allergenicity. Poly(acrylates) come from the polymerisation of acrylic acid esters. The group borne by acrylate can be an alkyl group or be varied in functionality, with a varying hydrophilic/hydrophobic nature, in order to confer original properties to the adhesive. The length of the chain is used as a variable to adjust the adhesive properties. Moreover, the presence of a methyl group in poly(methacrylates) is known to produce a higher  $T_g$  (see Section 2.3.3).

Acrylic copolymers are normally synthesised by free radical polymerisation to produce random copolymers of molecular weight typically in the range 200 000–1 000 000 g/mol. They are typically composed of mixtures of different monomers, the proportions being adjusted for a specific  $T_g$  value. Some acrylic monomers (commonly called ‘hard monomers’) are known to produce

**Table 4.7** Polymers used in the formulation of medical-grade pressure-sensitive adhesives (PSAs)

Polymer	Application	Requested functionality
Silicone (PDMS)	Transdermal drug-delivery systems	Chemically inert, biocompatible, high drug permeability
Poly(vinyl ether)	Skin patches, surgical dressings	Moisture permeability
Poly(vinyl pyrrolidone)	Ostomy	Moisture absorption
Polyacrylates	Transdermal drug-delivery systems	Chemically inert, ability to control drug release
	First-aid dressings	Quick adhesion, adherence during normal daily activity
	Electromedical devices	Long-term adhesion
	Surgical dressings	Moisture permeability
	Incise drapes	Sterilisable, wet stick
	Surgical tapes	Sterilisable
Hydrophilic gels	Electromedical applications	Moisture absorption, quick adhesion
Natural rubber and poly (isobutylene)	First-aid dressings	Adherence during normal daily activity, quick adhesion

hard homopolymers characterised by high  $T_g$ , and others ('soft monomers') are known to produce homopolymers with low  $T_g$ . Table 4.8 summarises the  $T_g$  of acrylic homopolymers prepared from typical monomers used in medical PSAs.

Various functionalities can be imparted to these adhesives, including high moisture vapour transmission rate (MVTR), which is of importance for

**Table 4.8** Glass transition temperatures ( $T_g$ ) of acrylic homopolymers derived from typical monomers used in medical pressure-sensitive adhesives (PSAs)

Monomer	$T_g$ of homopolymer	Rigidity of segment
<i>n</i> -Butyl acrylate	-54 °C	Soft segment
2-Ethylhexyl acrylate	-70 °C	Soft segment
Acrylic acid	106 °C	Hard segment
Vinyl acetate	30 °C	Hard segment
<i>n</i> -Butyl methacrylate	20 °C	Hard segment

prolonged duration of adhesion, for wet stick or for when adhesion on the wet skin is requested. Enduction processes are generally used for preparing adhesive devices, often requiring the use of solvent-based acrylic adhesives. Attempts have been made to develop alternative strategies, including the preparation of acrylic dispersions by emulsion polymerisation and the development of hot-melt adhesives.

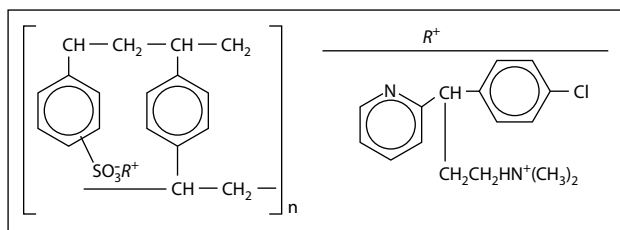
Silicones form the third category of PSAs. They have been used since the 1960s for bandages and medical tapes. Silicone adhesives are typically prepared from poly(dimethylsiloxane) and silicone resins, which are cross-linked to impart sufficient mechanical resistance to the adhesive. As silicone adhesives contain no plasticisers, no tackifiers and no stabilisers, they have excellent skin compatibility and make non-irritating, non-sensitising materials. Silicone adhesives are found in transdermal delivery systems because of their high permeability to drugs, allowing control of the delivery of various ingredients to the skin and subsequently yielding pharmacokinetic profiles extending over a few days.

#### 4.4.5 Ion-exchange resins

Immobilisation of drugs on ion-exchange resins has been proposed in pharmaceutical formulations for different applications such as taste-masking, improving drug stability, enhancing dissolution, and providing a sustained-release effect for orally active drugs. Ion-exchange resins are water-insoluble cross-linked polymers containing salt-forming groups in repeating position on the polymer chain. These insoluble polymeric porous particles or hydrogels contain basic or acidic groups, which can form ionic complexes with the oppositely charged drugs. Thus, the drug is bound to ion-exchange resin particles via electrostatic interactions. Once administered, and because they are insoluble in physiological fluids, ion-exchange resins are not absorbed from the gastrointestinal tract and do not have significant associated side-effects.

Taste-masking represents an interesting application of ion-exchange resins, since drugs do not display their original taste characteristics in a bound state. Most of the bitter drugs have an amine as a functional group, which is the cause of their taste. If the amino functional groups are blocked by complex formation with cationic resins, then the bitterness of these drugs can be drastically reduced. Once the drug is administered, and as the pH and ionic strength of the physiological fluids in the gastrointestinal tract change with time and location, the drug can be desorbed from the resin, possibly providing a sustained-release effect.

Strong acid anionic resins such as sulphonated styrene-divinyl benzene copolymers can be used to mask the taste of basic drugs with a bitter taste. They can be used almost throughout the entire physiological pH range above



**Figure 4.29** Sulphonated styrene-divinylbenzene copolymer complex with chlorphen amine.

pH6. Similarly, strong base cationic exchange resins are efficient throughout the entire pH range, while the weak base cationic exchange resins are functional below pH7. The apparent  $pK_a$  values of resins based on sulphonic, phosphoric and carboxylic acids as exchanger groups are in the range 1–2, 3 and 4–6, respectively. The apparent  $pK_a$  values of resins bearing quaternary, tertiary or secondary ammonium groups are in the ranges  $> 13$ , 7–9 and 5–9, respectively. The rate at which the drug can be released from its complex with the resin in the physiological fluids is significantly influenced by the apparent  $pK_a$  value of the resin.

Insoluble adsorbates or resinates are formed through weak ionic bonding of the resin with oppositely charged drugs, as shown in Figure 4.29. They are prepared either by soaking the purified resins in a solution of ionised drug or by passing a concentrated solution of drug through an ion-exchange-packed column until the effluent concentration is the same as in the eluent concentration. Drug complexation depends on the particle size, porosity and swelling, depending on the cross-linking degree, acid/base strength and available capacity of the resin. At the end of the preparation process, resinates are produced in the form of powders, which can be formulated to form solid dosage forms, such as tablets or capsules. In some cases, and because release can be very rapid in the presence of ions in saliva, a preventive coating with a semi-permeable membrane such as ethyl cellulose can be requested.

#### 4.4.6 Polymers for controlled delivery following parenteral administration

##### *Polymeric implants*

Parenteral delivery of drugs can be foreseen for various reasons, for example circumventing impaired oral absorption and achieving controlled release for a long duration. For this latter application, implants have been conceived for delivering drugs during an extended period of time, from months to years. Such applications are very demanding, since the polymers used for preparing implants must not only control the delivery of the drug but also be biocompatible and non-toxic. The preparation should be easily delivered, meaning

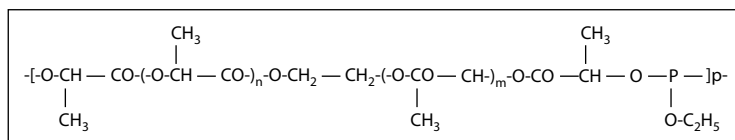
that soft or liquid preparations are of interest from this point of view. In order to avoid surgical removal, implant applications require the polymer to be biodegradable and to yield low-toxicity degradation products, which should not create any inflammation and should be cleared rapidly from the body. Moreover, the polymer must be able to encapsulate and efficiently control drug release during an extended period. Finally, specific mechanical properties (rigidity versus flexibility) may be requested. Because no single polymer is able to fulfil all of these criteria, a family of polymers has been progressively created by industry and academia, and nowadays a broad choice of polymers series is available to the formulator. Research in this area is focused increasingly on the development of polymers conceived specifically for exactly matching the requested criteria for specific delivery cases.

Poly( $\alpha$ -hydroxyacid)s are the leading biodegradable polymers that have been developed. The poly( $\alpha$ -hydroxyacid)s series of polymers includes PLA and PLGA as well as other polymers such as polycaprolactone and poly(butyric acid) (see Section 4.2). These well-known polymers have been studied extensively for implant applications, and many drug-delivery systems based on these polymers are now commercialised.

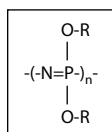
Apart from these polymers, some polyanhydrides have undergone active clinical development. Polyanhydrides involving sebacic acid (hydrophilic component) and carboxyphenoxypropane (hydrophobic component) have been used to develop a matrix for Gliadel<sup>®</sup>, a commercial product for the sustained release of carmustine, an anti-cancer drug used in the treatment of brain tumours. Other anhydrides have also been investigated, such as poly(erucic acid dimer : sebacic acid 50 : 50) copolymers for the development of implants for the antibiotic treatment of osteomyelitis.

Specifically designed polyphosphoesters (Figure 4.30) have been developed for applications in drug delivery and tissue engineering. Their composition can be modified to obtain polymers with a wide range of properties and useful versatile mechanical properties, making it possible to formulate injectable gels, elastomeric films and amorphous solids. The phosphate groups make the polymer more soluble in common organic solvents and improve the polymer flexibility. Finally, the phosphate groups impart hydrophilicity to the polymer, which reduces protein adsorption on the device surface.

Polyphosphazenes (Figure 4.31) contain alternating phosphorus-nitrogen double and single bonds and side-chain functionalities that can be varied to



**Figure 4.30** Example of polyphosphoester.



**Figure 4.31** General structure of polyphosphazenes.

obtain various series of polymers with a wide range of properties, including water solubility and degradability. Polyphosphazenes have been synthesised by reaction of poly(dichlorophosphazene) with organic nucleophiles such as alkoxides, aryl-oxides or amines. Water-soluble polyphosphazenes have attracted special attention due to the possibility of formulating sensitive drugs such as proteins and vaccines via a completely aqueous process.

Other series of polymers have also been investigated extensively, including hydrolytically labile poly(orthoester)s, poly(aminoacids) and pseudopoly-(amino acid)s.

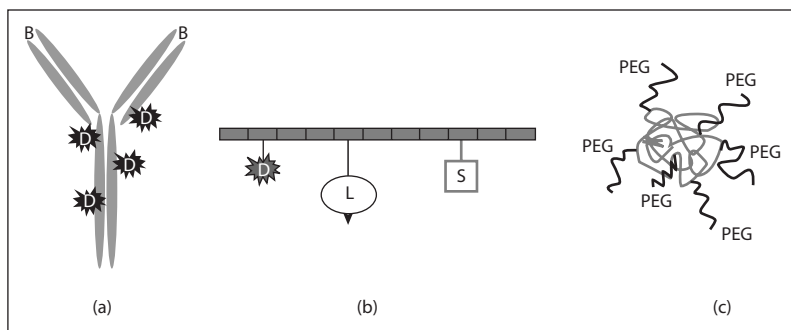
### *Polymer–drug conjugates and targeting by water-soluble polymeric conjugates*

Polymer–drug conjugates were born in the mid 1970s thanks to the development of monoclonal antibodies by Milstein and Köhler and to the Ringsdorf vision of what a polymeric drug carrier should be. The driving forces were searches for new drug-delivery platforms to improve the therapeutic index of drugs active against severe diseases but presenting major limitations. Typically, some drug candidates exhibit a short half-life in the bloodstream due to either a rapid degradation or rapid clearance rate. The smallest molecules distribute evenly in the body, diffusing in both diseased and healthy tissues. In consequence, only a small amount of the administered drug reaches the target tissue, and hence the therapy is associated with severe side-effects.

Several advantages were foreseen by using polymer–drug conjugates to improve the therapeutic efficacy of those drugs:

- Better control of the biodistribution of the drug by associating a targeting moiety; this led to the earlier strategy development of antibody–drug conjugates
- Improvement of the targeting efficacy based on multivalent interactions with target cells
- Protection against degradation
- Reduction of the immunogenicity of proteinic or peptidic drugs
- Prolonged retention of the drug in the blood compartment thanks to the reduction of renal clearance for the smallest drug molecules.

Then it appeared that conjugation of drugs with a polymer or macromolecule enhanced its passive distribution in favour to tumour tissue. This enhanced permeation and retention (EPR) effect was explained by differences



**Figure 4.32** Schematic representation of the three kinds of polymer–drug conjugates. (a) Antibody–drug conjugates with a mean of four drug molecules (D) per antibody. Each antibody has two binding sites (B) for high specificity of recognition for the corresponding antigen. (b) Polymer–drug conjugate built according to the original model of Ringsdorf. Many drug molecules (D), ligands for specific targeting (L) and chemical groups to adjust the solubilising properties of the conjugate (S) can be grafted on the polymer backbone (grey oblongs), which serves as a carrier. (c) PEGylated peptides or proteins are therapeutic peptides or proteins on which chains of poly(ethyleneglycol) (PEG) have been grafted.

in the biochemical and physiological characteristics between healthy and malignant tissues that allowed entry and accumulation of macromolecules only in solid tumours and not in healthy tissues. Another interesting benefit is the enhancement of the solubility of new cytotoxic drugs designed by the pharmaceutical industry. Many of these molecules displayed extremely high potential as anticancer agents in cell culture but their clinical development was hampered because their solubility characteristics made them extremely difficult to administer *in vivo*. In addition, their toxicological profile combined with their lack of specificity required them to be associated with a targeting strategy in order to improve their biodistribution towards diseased tissues.

Three types of polymer–drug conjugate have been described, as presented in Figure 4.32: antibody–drug conjugates, synthetic polymer–drug conjugates and PEGylated-peptides and proteins. All of these are built from the covalent coupling of drug molecules to a macromolecule. Therefore, from an industrial standpoint, polymer–drug conjugates can be considered more like new chemical entities. This implies that their development needs to follow the development route requested for a new drug. Indeed, the drug molecule is modified by the covalent attachment to the macromolecule. Thus, the resulting drug-delivery system cannot be considered as a conventional formulation in which the drug molecule remains chemically intact and is simply entrapped in the formulation. It is noteworthy that, despite this constraint, several marketed compounds are currently used in clinics and the Food and Drug Administration (FDA) has approved more macromolecular drugs than small molecules for a couple of years. In fact, the development of the first marketed compounds from these macromolecular drug conjugates has overcome many

challenging milestones, including the difficulty of obtaining a perfectly reproducible batch-to-batch synthesis of a polymer–drug conjugate with precise physicochemical characteristics. It has also been demonstrated that it is possible to validate all steps of the production by developing appropriate methods of analysis.

### **Antibody–drug conjugates**

The rationale behind the development of antibody–drug conjugates was to increase the specificity of the biodistribution of the drug (Figure 4.32a). Such conjugates result from the covalent attachment of drug molecules to antibodies. In such a construct, the two partners have to show perfect complementary actions. The antibody, which is mostly not cytotoxic, brings the high specificity of targeting, while the drug, generally a cytotoxic agent with a very poor selectivity for tumours, brings the cell-killing ability. Although most classical coupling reactions can be used, precautions must be taken to preserve both the antibody recognition specificity and the drug activity.

In practice, humanised monoclonal antibodies are used to avoid induction of an immune response. Other advantages of using these antibodies are their long half-life in the blood circulation (up to several days) and their non-toxicity during circulation. Some of them show a low cytotoxic effect when they interact with the corresponding antigens found on the target cell surface. However, as they are highly specific for a single antigen found only on the surface of the target tumour cells, their role is supposed to carry very specifically the cytotoxic agent. Antibodies showing an affinity towards its antigen of 1 nM expressed as the dissociation constant are considered as suitable to be used as a targeting tool. The linkage of the drug to the antibody is often achieved through a spacer. Based on the experience acquired by authors who have developed drug–antibody conjugates over the past 30 years, the linker between the drug and the antibody needs to be stable during circulation in blood but should be cleaved to release the original drug molecule after arrival at the destination.

Several types of linker have been investigated, including acidic sensitive bonds, covalent bonds cleavable by esterases or proteases, and disulfide bonds. Spacers including a disulfide bond present many advantages and have been used to synthesise antibody–drug conjugates of the last generation. They can be stable during the period of storage of the drug conjugate and remain intact in the blood. As required, they can be cleaved to release the drug in the intracellular medium of cancer cells because the amount of glutathione responsible for the scission of disulfide bounds is important in the intracellular medium (millimolar range versus micromolar range in the extracellular medium). In general, an average of four drug molecules can be grafted per antibody. The grafting occurs on the most accessible lysine residues among the 80 available on the antibody. Although this method of targeting presents



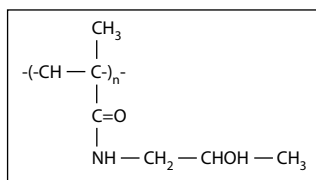
high potential for cytotoxic drugs to develop very efficient treatments with drugs presenting an adverse toxicological profile, the low number of drug molecules grafted per antibody may represent a limitation for the efficacy of the treatment.

In a very similar approach, it was suggested to use transferrin as a carrier and targeting tool for anticancer drugs. The rationale behind this idea was to use transferrin as the targeting moiety to recognise cells overexpressing the receptor for transferrin on their surface and allowing the drug to penetrate into cells via the internalisation route specific to the transferrin receptor.

### Synthetic polymer–drug conjugates

Conjugates obtained from synthetic polymers were developed as alternative carriers for drug targeting. These polymers are tailor-made according to the original model suggested by Ringsdorf (Figure 4.32b) as a function of the drug-targeting goal. They were extensively developed as tools for intralysosomal delivery of cytotoxic agents presenting major limitations for clinical applications. In general, the polymer backbone can host many drug molecules, which are linked to the polymer backbone through a spacer containing a bond, which can be cleaved when the conjugate has reached the target. Targeting moieties including small ligands, antibodies or antibody fragments are grafted on the same polymer chains, as are groups ensuring that the polymer remains fully soluble in biological media. High-molecular-weight species have been designed. This is required to promote passive targeting of the carrier to tumour tissue from the general circulation thanks to the EPR effect. However, the molecular weight should not exceed 100 000 g/mol in order to ensure endocytic internalisation by cells. In addition, the molecular weight of non-biodegradable polymers should be below 40 000 g/mol in order to allow final elimination by renal filtration. Nevertheless, higher-molecular-weight polymers can be designed by including cleavable bonds, which reduce the molecular weight, to allow internalisation by cells or final elimination. Once in the tumour, the targeting moieties grafted on the polymer ensure a high specificity of recognition of the target cells. In general, the affinity is also very high thanks to multivalent interactions between the carrier and the target cell because several targeting moieties can be carried on a single polymer–drug conjugate.

Besides the molecular weight requirements, other features are required to design an effective polymer–drug conjugate. The polymer used as the carrier must be non-toxic and non-immunogenic. The spacer between the drug molecule and the polymer should include a cleavable bond in order to allow release of the intact drug molecule only at arrival at the target site. Finally, the addition of solubilising groups may be required in case the original polymer becomes insoluble in biological fluids after grafting of the drug and the targeting moiety.



**Figure 4.33** Repeating unit of poly(2-hydroxypropylmethacrylamide).

Much experience has been acquired by designing poly(2-hydroxypropylmethacrylamide) (PHPMA; Figure 4.33) copolymers. Such copolymers were the first synthetic polymer–drug conjugates to be entered in human clinical trials. They are composed of a linear polymer backbone of PHPMA in which several of the hydroxypropyl groups serve as anchor either for the grafting of the drug through a spacer or for the grafting of the targeting ligand. These copolymers have been designed as lysosomotropic drug carriers for most of the first-line anticancer agents, including doxorubicin, paclitaxel and platinates (carboplatinate, 1,2-diaminocyclohexane platinite).

Another polymer candidate identified as a potential carrier is poly(glutamic acid). These polymer–drug conjugates were shown to highly enhance the therapeutic value of the drugs coupled to the polymer carrier. At the same time, they reduced drug toxicity thanks to better control of the biodistribution.

Polymer–drug conjugates can be designed as drug-delivery platforms to carry a cocktail of drugs in a single cell. In this case, at least two types of drug are grafted on a single polymer molecule. A straightforward application of such a drug-carrier system would be therapy of resistant cancer cells. Indeed, the different drugs carried on a single polymer chain would reach the same cells, where they could act in a synergistic manner to counteract the multicellular resistant pathways.

It is noteworthy that the first polymer–drug conjugates developed involved simple structures, i.e. linear polymers. Now it is possible to design polymers with more sophisticated architectures such as star-like or dendrimeric structures. Some of these novel architectures display interesting new properties, including stimuli-responsive abilities that could be integrated into polymer–drug conjugates. However, efforts are still needed to develop such architectures with polymers with suitable toxicological profiles for *in vivo* applications.

### Polymer–protein conjugates

Polymer–protein conjugates constitute the class of drug conjugates that is the most advanced in terms of clinical development and applications. Several such compounds are marketed and used routinely in oncology. In addition, the number of peptide-, protein- and antibody-based drugs entering into use in clinics is growing rapidly, giving new opportunities to develop conjugates to enhance the performance of the drugs. In fact, the main limitations of these

drugs are their short half-life because of their poor stability in biological fluids and the immunogenicity of the large proteins. Conjugation to a polymer was suggested to form a shield around the molecule, preventing the action of proteases and hence prolonging the half-life in the blood. Historically, the first polymer–protein conjugate consisted of an antitumor protein, neocarzinostatin (NCS), on which two chains of (styrene-alt-maleic anhydride) copolymer (SMA) were grafted. The resulting conjugate, SMANCS, was brought to market in 1990 to treat patients with primary liver cancer (hepatocellular carcinoma). The concept of building a shield around the protein with a synthetic polymer to protect it from degradation has been found to be very efficient.

The technology developed with SMA was not pursued but evolved towards the use of PEG for more convenient and safer protein therapeutics. The use of PEG presents several advantages. PEG is very well tolerated by the organism after intravenous administration. PEG has been found to reduce and even suppress the immunogenicity of proteins by shielding epitopes. Another interesting property brought by PEGylation is that it increases the solubility of the modified proteins in biological fluids. Finally, the pharmacokinetics of PEGylated proteins are highly modified compared with the pharmacokinetics of the corresponding native protein thanks to efficient protection of the protein drugs against degradation by proteases. All of these advantages place PEG in the first line of polymers used to design polymer–protein drug conjugates. The main applications are concerned with improvement of therapy with enzymes and cytokines.

In practice, there are many possibilities for attaching a PEG molecule to proteins and peptides. In general, a specific group is attached on the terminal hydroxyl group of the PEG chain, allowing chemical grafting on free amine, carboxylic, hydroxyl or thiol groups of the protein. It is noteworthy that only a few reactions can be applied for preserving the biological activity of the protein. The most used methods relied on chemical conjugation through reactive side-chain groups on the amino acids of the peptidic chains. This allowed selective grafting of the PEG chain on to defined amino acids of the protein. To improve the selectivity of the grafting method, it was suggested to use recombinant proteins in which a mutation was introduced on a much more defined amino acid in order to make attachment of the PEG chain possible. Although this method increased control of the grafting method, it required selection of a recombinant protein with the proper mutation for each therapeutic protein to be modified.

Alternative methods of highly selective coupling reactions were developed using enzymes. These methods were easier to develop on a large number of proteins with little effort. In the first example, the PEG chain can be transferred on an O-glycosylated site of glycosylated native proteins. The reaction can be catalysed by a specific enzyme, a glycosyl transferase, which confers a

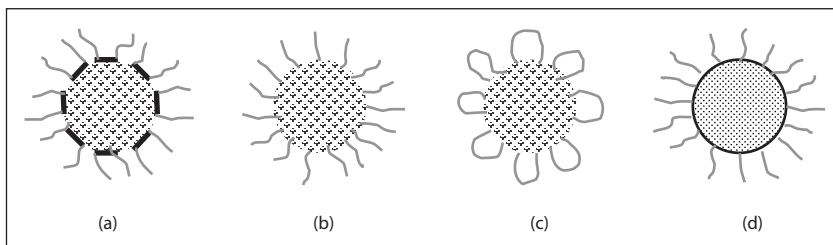
high specificity of the coupling reaction. The PEG chains are positioned exactly on the O-glycosylation site of the protein. This method of grafting was applied for PEGylation of three clinically used proteins – granulocyte colony-stimulating factor (G-CSF), interferon alpha2b (INF- $\alpha$ 2b), and granulocyte/macrophage colony-stimulating factor (GM-CSF).

In recent years, another enzymatic mediated modification was applied with success to bind PEG on proteins of clinical interest. The enzyme, a transglutaminase, allowed the transfer of an amino derivative of PEG, PEG-NH<sub>2</sub>, on a glutamine residue of the protein located in a flexible or unfolded region of the peptidic chain. Specificity of the enzyme was high and led to a very high degree of specificity for the PEGylation of the protein. This method of protein PEGylation has already been used successfully to produce several PEGylated proteins of clinical interest, including human growth hormone and interleukin 2. A promising development for the PEGylation of therapeutic peptides and proteins is expected in the future. Indeed, recent work has opened up the possibility of predicting sites of transglutaminase-mediated PEGylation of therapeutic proteins. This discovery has paved the road towards predicting the possible effects caused by the modification of the physicochemical and functional properties of the protein and will be very useful in the design of proper strategies for the modification of proteins.

#### *Polymeric nanoparticles for drug delivery*

Nanoparticles, i.e. particles with a size usually in the range 50–1000 nm, have drawn the attention of researchers designing drug-delivery systems that can be injected intravenously owing to their small size. Nanoparticle is a general name for nanospheres and nanocapsules. Nanospheres have a matrix-type structure, whereas nanocapsules are hollow and have a liquid core surrounded by a polymeric wall, as illustrated in Figure 4.34.

Several methods have been developed for preparing nanoparticles. They can be classified into two main categories according to whether the formation of nanoparticles occurs during a polymerisation reaction or whether it is achieved directly from already prepared macromolecules.

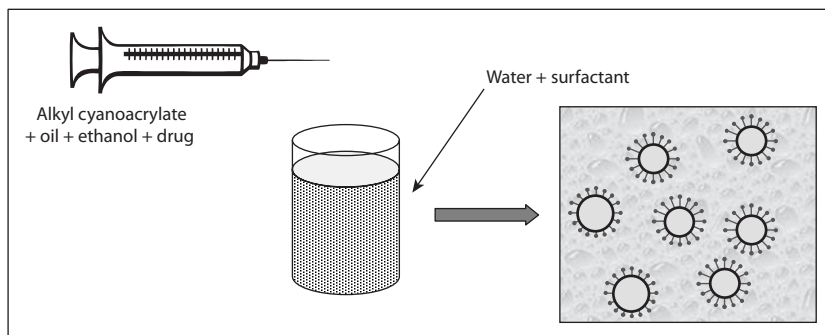


**Figure 4.34** Different types of nanoparticle: (a) nanosphere stabilised by an adsorbed non-ionic surfactant; (b) core-shell nanosphere with a brush shell structure; (c) core-shell nanosphere with a loop shell structure; (d) core-shell nanocapsule with a brush shell structure.

In the biomedical field, polymeric colloidal systems have been proposed for years as supporting surfaces for diagnostic tests, owing to their high specific surface area, high stability and ease of handling. Such nanoparticles can be easily prepared from several monomers by free radical emulsion polymerisation (see Section 3.7.2). In the pharmaceutical field, nanoparticles made of non-biodegradable polymers such as polyacrylamide or poly(methyl-methacrylate) were proposed during the 1970s as adjuvants for vaccines. Since then, the technology for making polymeric nanoparticles has been adapted to the many requirements for a drug carrier, including biocompatibility, biodegradability, compatibility with the drug to be carried, drug-loading efficacy, defined drug-releasing properties and in vivo targeting.

Anionic emulsion polymerisation of alkylcyanoacrylates (ACA) was introduced to design bioerodible polymeric nanospheres or nanocapsules suitable for in vivo delivery of drugs. Emulsions formulated to prepare poly(alkylcyanoacrylates) (PACA) nanospheres to be used as drug carriers were rather complex. The monomer ACA is dispersed in acidified water containing a surfactant or a stabilising agent and the drug. This system is left to polymerise spontaneously for a few hours. The resulting colloidal polymeric particles have a diameter ranging from 50 nm to 300 nm. Nanocapsules can be prepared by interfacial polymerisation of ACA performed in micro-emulsion. Oil-containing nanocapsules are obtained by polymerisation of ACA at the oil/water interface of a very fine oil-in-water emulsion. In practice, the oil, the monomer and the drug are dissolved in a water-miscible organic solvent to prepare the organic phase. This organic phase is injected in the aqueous phase containing a surfactant through a fine needle and under strong magnetic stirring. A milky suspension of nanocapsules forms immediately. The organic phase is then removed under reduced pressure. Preparation of oil-containing nanocapsules is illustrated in Figure 4.35.

Water-containing nanocapsules can be obtained by interfacial polymerisation of ACA in water-in-oil micro-emulsion. In such a system, water-swollen micelles of surfactants of small and uniform size are dispersed in



**Figure 4.35** Formation of nanocapsules by interfacial polymerisation.

an organic phase. The monomer is added to the oily phase once the micro-emulsion has formed and the anionic polymerisation is initiated at the surface of the water swollen micelles. The polymer that forms locally at the water/oil interface precipitates, allowing formation of the nanocapsule shell. Nanocapsules obtained by this method are of special interest for the encapsulation of water-soluble molecules such as peptides.

Nanoparticles can also be obtained from a polymer that has previously been prepared according to a totally independent method. The general principle is based on the solubility properties of the polymer. A diluted solution of the polymer is prepared and a phase separation is induced by addition of a non-solvent or by a salting-out effect. Once the proper conditions to form polymeric colloids are identified, the particles can be stabilised either by elimination of the polymer solvent by evaporation or by chemical cross-linking of the polymer.

Nanospheres and nanocapsules can also be prepared by the same methods as those described for microparticles, except that manufacturing parameters have to be adjusted in order to obtain nanometre-size droplets. Micro-encapsulation techniques adapted for making nanoparticles require formation of an emulsion as a first step of the procedure. Special equipment is needed to reduce the droplet size of the emulsion during dispersion of the polymer solution into the continuous aqueous phase. This equipment is a high-pressure homogeniser and a micro-fluidiser in which a very high energy input is produced. The drug is usually dispersed in the matrix of the nanospheres or dissolved in the core of the nanocapsules. The drug can also be adsorbed on the surface of the nanoparticles.

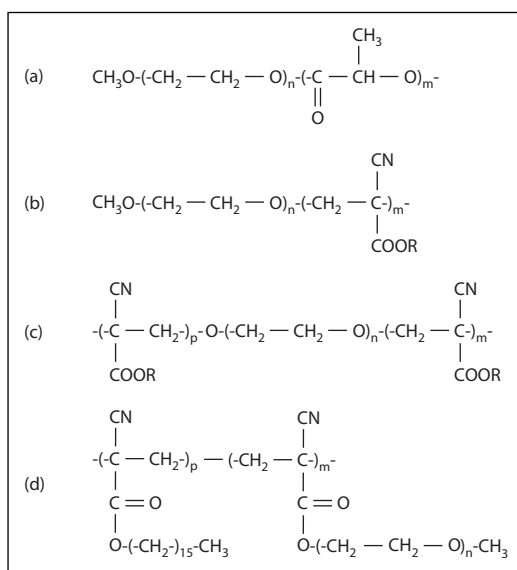
The main advantage of colloidal drug carrier systems is their submicronic size range. Provided that they do not aggregate, nanoparticles can be administered intravenously without any risk of embolisation and can diffuse through capillary vessels and mucosae. Despite the small size of nanoparticles, it has been shown that they are quickly removed from the circulation after intravenous administration. The uptake by macrophages located in the organs of the mononuclear phagocytic system (MPS) is mediated by particle interaction with opsonins, mainly the complement system, which plays a key role in the non-specific recognition and uptake of foreign bodies. Thus, delivery of drugs carried by nanoparticles to these organs is facilitated, and advantage can be taken of the uptake for delivering drugs, for instance inside infected phagocytes. Indeed, the low efficacy of some drugs is often related to a low uptake of the free drug. Some drugs are also cardiotoxic and can not be administered free. In both cases, delivering such drugs mainly to phagocytes has been shown to be of great interest. Delivery of cytotoxic drugs incorporated into some nanoparticles to multidrug-resistant cancer cells has also been shown to reverse resistance.

Such a particle size range and the associated large specific surface area are also desirable for the oral, lymphatic and pulmonary routes, and for ocular,

subcutaneous and intramuscular administration, offering new functions such as increased duration of contact and adhesion to tissues. A lot of work has been done on vaccine delivery by nanoparticles through different routes, and the large specific surface area of such systems has increased the adjuvant properties. Many reviews are available on such applications of nanoparticles.

Despite these already cited uses, site-specific delivery of drugs to tissues and organs other than MPS through intravenous injection has been hindered by the uptake by phagocytes. In an attempt to reduce opsonisation followed by fast uptake by phagocytes, the concept of steric stabilisation of particles has been introduced. To this end, nanoparticles with prolonged blood circulation times have been designed. These nanoparticles usually comprise a hydrophobic biodegradable core stabilised by a hydrophilic shell. They are spontaneously formed in aqueous phase from amphiphilic block copolymers, i.e. polymeric surfactants, in which a long enough hydrophobic block is bound to the hydrophilic block by a covalent linkage. The most popular systems designed for human use have been obtained by preparing block copolymers in which poly(ethylene oxide) (PEO) or PEG are introduced as the hydrophilic blocks of the copolymers. The hydrophobic blocks associated with PEO and PEG are composed of PLA, PLGA or PACA. Diblock, triblock and graft copolymers have been obtained and are illustrated in Figure 4.36.

Special attention should be devoted to nanoparticles obtained from copolymers containing sugars or polysaccharides as constituents of the



**Figure 4.36** Block and graft amphiphilic copolymers leading to core-shell nanoparticles in aqueous solutions: (a) PEO-PLA diblock copolymer, (b) PEO-PACA diblock copolymer, (c) PACA-PEG-PACA triblock copolymer, and (d) Poly[hexadecyl cyanoacrylate-graft-(PEO)-] copolymer.

hydrophilic shell. Sugars are present on the surface of cells and are involved in many surface properties of the cells. Therefore, biomimetic strategies could be developed that take advantage of the presence of polysaccharides on the surface of the nanoparticles. A few polysaccharides are already administered to humans, for instance dextran and heparin. Heparin is well known for its anticoagulant activity and has been shown to act as a physiological inhibitor of complement activation. In order to mimic the behaviour of cells and pathogens that normally escape recognition by complement and phagocytes, block copolymers of heparin and poly(methylmethacrylate) or PACA have been produced and heparin-coated nanospheres have been prepared. These nanospheres have been shown to be non-activators of complement *in vitro*. *In vivo*, after intravenous administration to mice, these nanospheres could remain in the bloodstream and show long circulating properties. In addition, it has been shown that the conformation of the polysaccharide chains grafted on the nanosphere surface could play a very important role in defining the fate of the colloidal particle after intravenous administration. Indeed, a long enough dextran bound to nanospheres by one end, i.e. in brush conformation (Figure 4.34b), has been shown to be as low an activator of complement as soluble dextran, whereas the same dextran bound by several bonds, i.e. in loops and train conformation (Figure 4.34c), is as strong an activator as cross-linked dextran, i.e. Sephadex. Block copolymers obtained from other polysaccharides and PACA could be obtained in brush conformation. Provided that the polysaccharide chains are long enough, they could be low activators of complement and have been developed for purposes in which at least long-circulating properties are required.

Core-shell nanoparticles with a heparin and/or dextran shell in brush conformation have been shown to be able to carry functional haemoglobin and to protect it from degradation. Similarly, core-shell nanoparticles with a chitosan shell in brush conformation have been shown able to carry siRNA active against cancer in a mice model after intravenous administration.

#### 4.4.7 Safety and recognition of new polymers as excipients

Pharmaceutical excipients have a vital role in drug formulations. However, the development of new excipients is often neglected because of a lack of mechanisms to assess the safety of excipients outside a new drug application process. Existing regulations and guidelines state that new excipients should be treated as new chemical entities with full toxicological evaluation. Therefore, successful development of new polymeric excipients depends on obtaining appropriate toxicological data on the safety and biocompatibility of such excipients. There exist specific relevant guidelines for specific delivery systems, such as implant applications, which have been developed by the United States Pharmacopoeia (USP) for testing of the polymer safety and



tissue irritability. One example of such a test is the USP Biological Reactivity Test, *in vivo*, which includes the systemic injection test, the intracutaneous test and the implantation test. Such guidelines may be of relevance when developing a polymer excipient for parenteral controlled-release applications. Other guidelines from the European Medicines Evaluation Agency (EMEA) and the FDA describe the type of data package required in the preclinical development of a new excipient.

## Bibliography

### Polymeric biomaterials

- Arshady R, ed. (1999). *Microspheres, Microcapsules and Liposomes. Vol. 2: Medical and Biotechnology Applications*. London: Citus Books.
- Barbucci R, ed. (2002). *Integrated Biomaterials Science*. New York: Kluwer Academic/Plenum.
- Dumitriu S, ed. (2001). *Polymeric Biomaterials*, 2nd edn. New York: Marcel Dekker.
- Vert M (2007). Polymeric biomaterials: strategies of the past vs. strategies of the future. *Prog Polym Sci* 32: 755–761.
- Williams DF, ed. (1987). *Definitions in Biomaterials*. Oxford: Elsevier.

### Excipients for formulation of conventional dosage forms

- American Pharmaceutical Association and the Pharmaceutical Society of Great Britain, eds (2006). *Handbook of Pharmaceutical Excipients*, 5th edn. London: Pharmaceutical Press.
- Robyt JF, ed. (1998). *Essentials of Carbohydrate Chemistry*. New York: Springer.
- Dumitriu S, ed. (2004). *Polysaccharides: Structural Diversity and Functional Versatility*, 2nd edn. Hoboken: CRC Press.

### Polymers as excipients for controlled release by the oral route

- Gupta P, Vermani K, Garg S (2002). Hydrogels: from controlled release to pH-responsive drug delivery. *Drug Discov Today* 7: 569–579.
- Ponchel G, Irache JM (1998). Specific and non-specific bioadhesive particulate systems for oral delivery to the gastrointestinal tract. *Adv Drug Deliv Rev* 34: 191–219.

### Polymers for coating applications

- American Society for Testing and Materials (ASTM) (2001). Monograph F 372–99. Standard test method for water vapor transmission rate through plastic film and sheeting using a modulated infrared sensor. West Conshohocken, PA: American Society for Testing and Materials.
- Ginity JW, ed. (1996). *Aqueous Polymeric Coatings for Pharmaceutical Dosage Forms*, 2nd rev. expanded edn. New York: Marcel Dekker.
- Hercules Technical Bulletin. VC-556C. FMC's excipients for pharmaceutical tablets, capsules and suspensions. The use of Klucel® Pharm hydroxypropylcellulose to increase the utility of hydroxypropyl methylcellulose in aqueous film coating.
- Hercules Technical Bulletin. VC-598A. Klucel® EF Pharm hydroxypropylcellulose use in plasticizer-free aqueous film coating.
- International Organization for Standardization (ISO) (1995). ISO 2528. Sheet materials. Determination of water vapour transmission rate by the gravimetric (dish) method. Geneva: International Organization for Standardization.

- Siepmann F, Siepmann J, Walther M, MacRae RJ, Bodmeier R (2008). Polymer blends for controlled release coatings. *J Control Release* 125: 1–15.
- Wood RW, Mulski MJ (1989). Methodology for the determination of water vapor transport across plastic films. *Int J Pharmaceutics* 50: 61–66.

### Adhesive polymers for skin delivery

- Benedek I, Feldstein MM, eds (2008). *Applications of Pressure-Sensitive Products*. Hoboken: CRC Press.
- Satas D (1991). Pressure-sensitive adhesives. In: Szycher M, ed. *High Performance Biomaterials: A Comprehensive Guide to Medical and Pharmaceutical Applications*. Hoboken: CRC Press.
- Webster I (1997). Recent developments in pressure sensitive adhesives for medical applications. *Int J Adhesion Adhesives* 17: 69–73.

### Polymer–drug conjugates and targeting by water-soluble polymeric conjugates

- Chari RVJ (2008). Target cancer therapy: conferring specificity to cytotoxic drugs. *Acc Chem Res* 41: 98–107.
- Duncan R (2007). Designing polymer conjugates as lysosomotropic nanomedicines. *Biochem Soc Trans* 35: 56–59.
- Duncan R, Ringsdorf H, Satchi-Fainaro R (2006). Polymer therapeutics: polymers as drugs, drug and protein conjugates and gene delivery systems. Past, present and future opportunities. *J Drug Target* 14: 337–341.
- Fontana A, Spolaore B, Mero A, Veronese FM (2008). Site specific modification and PEGylation of pharmaceutical proteins mediated by transglutaminase. *Adv Drug Delivery Rev* 60: 13–28.
- Kratz F, Ajai KA, Warnecke A (2007). Anticancer carrier-linked prodrugs in clinical trials. *Expert Opin Investig Drugs* 17: 1037–1058.

### Polymeric nanoparticles for drug delivery

- Arshady R, ed. (2006). *Microspheres, Microcapsules and Liposomes. Vol. 8: Smart Nanoparticles in Nanomedicine*. London: Kentus Books.
- Chauvierre C, Vauthier C, Labarre D, Couvreur P, Marden MC, Leclerc L (2004). A new generation of polymer nanoparticles for drug delivery. *Cell Mol Biol* 50: 233–239.
- Uchegbu I, Schätzlein A, eds (2006). *Polymers in Drug Delivery*. Boca Raton, FL: CRC Taylor & Francis.
- Vauthier C, Labarre D (2008). Modular biomimetic drug delivery systems. *J Drug Deliv Sci Technol* 18: 59–68.



# Glossary

Amphiphilic copolymer	Copolymer with hydrophilic and hydrophobic blocks
Biocompatibility	Ability of a material to perform with an appropriate host response in a specific application
Biodegradable polymer	Polymer that can be degraded <i>in vivo</i> into smaller products, i.e. the main chain of the polymer can be cleaved
Biomaterial	Non-viable material used in a medical device, intended to interact with biological systems
Biopolymer	Polymer obtained by biosynthesis
Cohesive energy	For a solid, the energy required to break the atoms of the solid into isolated atomic species. Cohesive energy is related to solubility parameters
Colloid	System in which finely divided particles, approximately 1–1000 nm in size, are dispersed within a continuous medium in a manner that prevents them from being filtered or settled easily
Compliance	In mechanical science (cf. rheology), the inverse of stiffness
Copolymer	Polymer made up of two or more monomers
Critical micelle concentration (CMC)	Concentration above which micelles are spontaneously formed, i.e. above CMC micelles are in equilibrium with single chains
Cross-links	Bonds that link one polymer chain to another
Crystallinity	Degree of structural order in a solid. In a crystal, the atoms or molecules are arranged in a regular, periodic manner. Amorphous materials, such as liquids and glasses, have order over only short distances

Cyclodextrins	Family of cyclic oligosaccharides, composed of $\alpha$ -D-glucopyranoside units linked 1->4, as in amylose. Typical cyclodextrins contain six to eight glucose units in a ring, creating a cone shape
Glass transition temperature ( $T_g$ )	Temperature at which the amorphous domains of polymers undergo a second-order phase transition from a rubbery, viscous solid, to a brittle, glassy solid
Hydrogel	Water-insoluble, three-dimensional network of polymeric chains that is capable of swelling substantially in aqueous conditions
Macromolecule	High-molecular-weight molecule
Magnetic resonance imaging (MRI)	Medical imaging technique used to visualise detailed internal structure of the body. MRI uses a magnetic field to align the nuclear magnetisation of hydrogen atoms in water in the body
Medical device	Product used for medical purposes in patients, in diagnosis, therapy or surgery. The effect of the medical device is primarily physical, in contrast to pharmaceutical drugs, which exert a biochemical effect. Complete definition of a medical device can be found in ISO 13485 Standard
Micelle	Submicronic aggregation of molecules, as a droplet in a colloidal system
Monomer	Low-molecular-weight compound that can be connected together to give a polymer
Oligomer	Short polymer chain
PEGylation	Modification by attachment of PEG
Polydispersity	Equivalent to polymolecularity
Poly(ethylene glycol) (PEG) and poly(ethylene oxide) (PEO)	The repeating monomer units are similar in these, but due to different methods of synthesis, both chain ends of PEG are OH, whereas only one chain end of PEO is OH. Chains of PEO can be longer than chains of PEG
Polymer	High-molecular-weight molecule made up of small repeat units (monomer units) connected to each other by covalent bonds
Polymerisation	Process of linking together monomer molecules through chemical reactions
Polymolecularity	Distribution in molecular weight of the population of polymer chains
Polyolefin	Polymer made from olefins (alkenes, e.g. ethylene) monomers

Polypeptide	Polymer composed of amino acids
Polysaccharide	Polymer composed of sugars
Protein	Macromolecule mainly obtained by biosynthesis, composed of either amino acids and sugars (glycoproteins) or amino acids and lipids (lipoproteins)
Rheology	Study of the flow of matter
Solubility parameter ( $\delta$ )	Parameter used in predicting the solubility of non-electrolytes (including amorphous polymers) in a given solvent. The Hildebrand solubility parameter provides a numerical estimate of the degree of interaction between materials and solvents. The Hildebrand solubility parameter is the square root of the cohesive energy density
Stiffness	Resistance of an elastic body to deformation by an applied force
Swelling	Increase in volume, due to interactions between solvent and polymer chains, resulting in increasing polymeric chain mobility, which can lead to possible solubilisation
Vulcanisation	Process in which rubber is slightly cross-linked by reaction with sulphur



# Index

- abbreviations, xi–xii
- adhesive polymers for skin delivery,
  - pharmaceutical uses of polymers, 131–134
- alternating copolymers, 80–81
- anionic chain polymerisation, 67–71
- antibody-drug conjugates, 139–141
  
- Bakelite, 41
- bioadhesive polymers for mucosal
  - delivery, controlled-release delivery systems, 121–124
- biocompatibility
  - concepts, 100–105
  - definitions, 100–105
  - tissue compatibility, 102–103
  - toxicity, 100–101
- biodegradable/bioerodible polymers, 91–98, 92–93
- biomedical uses of polymers, 98–99
  - biocompatibility, 100–105
  - blood compatibility, 103–105
  - breast prostheses, 106–107
  - catheters, 111–114
  - chemo-embolisation, 111–114
  - embolisation, 111–114
  - haemodialysers, 107–109
  - hip prostheses, 56, 105–106
  - knee prostheses, 105–106
  - microparticles, 111–114
  - ophthalmology, 109–110
  - processing and fabrication, 98–99
  - sterilisation of polymers, 99–100
  - therapeutic embolisation, 111–114
- biopolymers, 2–3
- block copolymers, 81
  - phase separation, 87–91
  - phase-separated materials, 90–91
  - solution properties, 87–90
- blood compatibility, biomedical uses of
  - polymers, 103–105
- blood contacting devices, 104
- blood storage, poly(vinyl chloride) (PVC), 56
- bond polarity influence, 65
- breast prostheses, biomedical uses of
  - polymers, 106–107
- bulk polymerisation, 73–75
  
- Carbopol polymers, semi-solid preparations, 116–118
- catheters, biomedical uses of polymers, 111–114
- cationic chain polymerisation, 71–73
- cellulose, 2–3, 3
  - modifications, 4, 82–84
- chain polymerisation, 56–58
  - free radical chain polymerisation, 59–64
- chain-end analysis, molecular weight determination, 28
- chemo-embolisation, biomedical uses of
  - polymers, 111–114
- chitin, 2–3
- cis-trans* isomerism, 15–16
  - rubber, 15–16
- coating applications, pharmaceutical use, 125–131
  - drug interactions, 131



- enteric coatings, 126–127
- mechanical testing, 130–131
- oxygen permeability, 128–130
- polymers used, 126
- thermal properties, 130
- water vapour permeability, 127–128
- coating materials, polymer dispersions, 42–43
- cohesion of materials
  - crystallinity influence, 45–46
  - glass transition of amorphous domains, 46–48, 47
  - molecular weight influence, 22, 44–45, 45
  - structure of polymers, 44, 44–48, 65
- composition determination, copolymers, 31–35
- controlled-release delivery systems
  - bioadhesive polymers for mucosal delivery, 121–124
  - gastrointestinal tract, 121, 126–127
  - hydrophilic polymers for matrices
    - formulation, 120–121
  - mucosal delivery, 121–124
  - pharmaceutical uses of polymers, 118–124, 126–127
- copolymerisation, 80–81
  - alternating copolymers, 80–81
  - block copolymers, 81
  - graft copolymers, 81
  - random copolymers, 80–81
- copolymers
  - composition, 20
  - composition determination, 31–35
  - defining, 5–6
  - elemental analysis, composition
    - determination, 31–33, 33
  - infrared spectroscopy, composition
    - determination, 34
  - NMR, composition determination, 33–34
  - nomenclature, 13
  - Raman spectroscopy, composition
    - determination, 34–35
  - spectroscopic methods, composition
    - determination, 33–35
- cross-linking, gels and hydrogels, 38–39
- crystallinity influence, cohesion of materials, 45–46
- definitions, 5–6
- dextrans, 3
  - structure, 3
- drawbacks, technical-grade polymers, 56
- drug interactions, coating applications, 131
- drug-delivery systems, polymer dispersions, 43–44
- drugs uses. *See* pharmaceutical uses of polymers
- elemental analysis, copolymers
  - composition determination, 32, 31–33, 33
- embolisation, biomedical uses of polymers, 111–114
- emulsion polymerisation, 76, 77–79
- Eudragit, 39–40, 128, 129
- excipients
  - pharmaceutical uses of polymers, 114–118, 147–148
  - recognition of new polymers, 147–148
  - safety, 147–148
  - semi-solid preparations, 116–118
  - tableting, 115–116
- free radical chain polymerisation, 59–64
  - controlled radical chain
    - polymerisation, 64
  - generation of radicals, 59–61
  - initiation, 59–61
  - limitation, 65
  - monomer reaction, 61–62
  - polarity of bonds, 65
  - propagation, 61–62
  - termination, 61–62
  - transfers, 62–63
- gastrointestinal tract, controlled-release delivery systems, 121, 126–127
- gels and hydrogels, 2, 37–42
  - cross-linking, 38–39

- Eudragit, 39, 39–40, 40, 128, 129
- ionic gelation, 39–40
- MRI, 42
- physicochemical mechanisms of formation, 40–41
- poly(2-hydroxyethyl methacrylate) (PHEMA), 42
- properties, 41–42
- types, 38
- glass transition of amorphous domains, cohesion of materials, 46–48, 47
- glycosaminoglycans, 3, 4
- graft copolymers, 81
- haemodialysers, biomedical uses of polymers, 104, 107–109
- HDPE. *See* high-density polyethylene
- heparins, 4
- heterogeneous systems, polymerisation in, 75–79
- high-density polyethylene (HDPE), 45–46
- hip prostheses, 105–106
- hip prostheses  
biomedical uses of polymers, 105–106
- high-density polyethylene (HDPE), 105–106
- poly(methyl methacrylate) (PMMA), 105–106
- poly(tetrafluoroethylene) (PTFE), 56
- history, polymers, 4–5
- homogenous systems, polymerisation in, 73–75
- homopolymers, defining, 5–6
- hydrogels. *See* gels and hydrogels
- hydrophilic polymers for matrices  
formulation, controlled-release delivery systems, 120–121
- immunogenicity, tissue compatibility, 102–103
- inflammatory response, tissue compatibility, 102–103
- infrared spectroscopy, copolymers composition determination, 34
- interfacial polymerisation, 79–80
- ion-exchange resins, pharmaceutical uses of polymers, 134–135
- ionic gelation, gels and hydrogels, 39–40
- isomerism, 13–16
- knee prostheses, biomedical uses of polymers, 105–106
- LDPE. *See* low-density polyethylene
- limitations of polymerisation, 64–66
- depolymerisation, 66
- free radical chain polymerisation, 65
- polarity of bonds, 65
- steric hindrance, 64–65
- thermodynamic limitation, 66
- linear polymers, 6–13
- abbreviated names, 10–12
- chemical names, 10–12
- density, 10–12
- monomer units, 10–12
- morphology, 6–13
- nomenclature, 6–13, 8
- liquid media, polymer properties, 35–44
- low-density polyethylene (LDPE), 45–46
- macromolecular nature, polymers, 4–5
- macromolecules, 2. *See also* polymers
- polymolecularity, 19
- specific properties, 19
- magnetic resonance imaging (MRI), gels and hydrogels, 42
- MALDI-TOF. *See* matrix-assisted laser desorption/ionisation-time-of-flight
- Mark-Houwink-Sakurada relationship, 4
- matrix-assisted laser desorption/ionisation-time-of-flight (MALDI-TOF), molecular weight determination, 25–28
- mechanical properties, properties of polymers as materials, 48–50
- mechanical testing, coating applications, pharmaceutical use, 130–131
- micro-emulsion polymerisation, 76, 77–79

- microparticles, biomedical uses of
  - polymers, 111–114
- mini-emulsion polymerisation, 76, 77–79
- modifications
  - cellulose, 4, 82–84
  - poly(vinyl acetate), 84
  - polymers, 81–84
  - polysaccharides, 82–84
- molecular weight determination
  - chain-end analysis, 28
  - MALDI-TOF, 25–28
  - polymers, 20–30
  - polymolecularity, 22–23
  - size-exclusion chromatography, 23–25
  - viscosity, 28–30
- molecular weight influence, cohesion of
  - materials, 22, 44–45, 45
- monomer units, 2
  - defining, 5–6
  - linear polymers, 10–12
- monomers derivatives
  - abbreviated names, 10–12
  - chemical names, 10–12
  - density, 10–12
- monomers, defining, 5–6
- morphology
  - linear polymers, 6–13
  - polymers, 6–16
- MRI. *See* magnetic resonance imaging
- mucosal delivery, controlled-release
  - delivery systems, 121–124
- N*-acetylglucosamine, 2–3
- nanoparticles, polymeric nanoparticles
  - for drug delivery, 143–147
- need to synthesise polymers, 55–56
- NMR. *See* nuclear magnetic resonance
- nomenclature
  - copolymers, 13
  - linear polymers, 8, 6–13, 10–12
  - organic linear polymers, 6–13
  - polymers, 6–16
- nuclear magnetic resonance (NMR),
  - copolymers composition
    - determination, 33–34
  - ophthalmology, biomedical uses of
    - polymers, 109–110
  - optically active polymers,
    - stereoisomerism, 15
  - organic linear polymers, nomenclature,
    - 6–13
  - origins, polymers, 2–3
  - oxygen permeability, coating
    - applications, pharmaceutical use,
      - 128–130
- pharmaceutical uses of polymers,
  - 114–148
    - adhesive polymers for skin delivery,
      - 131–134
    - antibody-drug conjugates, 139–141
    - coating applications, 125–131
    - controlled-release delivery systems,
      - 118–124, 126–127
    - excipients, 114–118, 147–148
    - ion-exchange resins, 134–135
    - polymer for controlled delivery
      - following parenteral
        - administration, 135–147
    - polymeric implants, 135–139
    - polymeric nanoparticles for drug
      - delivery, 143–147
    - polymer-protein conjugates, 141–143
    - pressure-sensitive adhesives (PSAs),
      - 131–134, 133
- PHEMA. *See* poly(2-hydroxyethyl
  - methacrylate)
- PMMA. *See* poly(methyl methacrylate)
- poly(2-hydroxyethyl methacrylate)
  - (PHEMA), 42
- poly(ethylene glycol) (PEG), 70
- poly(ethylene oxide) (PEO), 70
- poly(methyl methacrylate) (PMMA), hip
  - prostheses, 105–106
- poly(tetrafluoroethylene) (PTFE), hip
  - prostheses, 56
- poly(vinyl acetate) modifications, 84
- poly(vinyl chloride) (PVC), blood
  - storage, 56
- polyacrylics and polymethacrylics
  - abbreviated names, 10–12

- chemical names, 10–12
- density, 10–12
- polyethylene
  - high-density polyethylene (HDPE), 45–46
  - high-density polyethylene (HDPE), hip prostheses, 105–106
  - low-density polyethylene (LDPE), 45–46, 62–63
- polyisoprenes. *See* rubber
- polymer dispersions, 42–44
  - coating materials, 42–43
  - drug-delivery systems, 43–44
  - polymer micelles, 43–44
- polymer micelles, polymer dispersions, 43–44
- polymer properties, liquid media, 35–44
- polymer solutions, 35–37
  - preparation, 35–37
  - properties, 35–37
- polymerisation
  - defining, 5–6
  - limitations, 64–66
- polymerisation in heterogeneous systems, 75–80, 76
  - emulsion polymerisation, 76, 77–79
  - interfacial polymerisation, 79
  - suspension polymerisation, 76, 77
- polymerisation in homogenous systems, 73–75
  - polymerisation in heterogeneous systems, 75–80
- polymerisation reaction processes, 73–80
  - bulk polymerisation, 73–75
  - polymerisation in homogenous systems, 73–75
- polymers. *See also* macromolecules
  - defining, 5–6
  - history, 4–5
  - macromolecular nature, 4–5
  - molecular weight determination, 20–30
  - morphology, 6–16
  - natural origin, 2–3
  - nomenclature, 6–16
  - origins, 2–3
  - polymolecularity, 20
  - purity, 2
  - surface properties, 1–2
  - thermal properties determination, 30–31
  - uses, 1–2
- polymolecularity, 3
  - macromolecules, 19
  - molecular weight determination, 22–23
  - polymers, 20
- polyolefins, 2–3
  - abbreviated names, 10–12
  - chemical names, 10–12
  - density, 10–12
  - monomer units, 10–12
- polypeptides, 2
- polypropylene, stereoisomerism, 14
- polysaccharides, 2–3, 3
  - modifications, 82–84
- polystyrene (PS), 1–2
- polyvinyl chloride, 4
- polyvinyls and polyvinylidenics
  - abbreviated names, 10–12
  - chemical names, 10–12
  - density, 10–12
- prepolymers, step polymerisation, 58–59
- pressure-sensitive adhesives (PSAs),
  - pharmaceutical uses of polymers, 131–134, 133
- processing and fabrication, biomedical uses of polymers, 98–99
- properties of polymers as materials, 48–53
  - mechanical properties, 48–50
  - surface properties, 50–53, 52
- properties, surface, polymers, 1–2
- proteins, 2
  - polymer-protein conjugates, 141–143
- PS. *See* polystyrene
- PSAs. *See* pressure-sensitive adhesives
- purity, polymers, 2
- Raman spectroscopy, copolymers
  - composition determination, 34–35

- random copolymers, 80–81
- ring opening polymerisation, 69
- rubber, 4
  - cis-trans* isomerism, 15–16
  - properties, 15–16
- semi-solid preparations
  - Carbopol polymers, 116–118
  - excipients, 116–118
- size-exclusion chromatography,
  - molecular weight determination, 23–25
- skin delivery, pharmaceutical uses of polymers, 131–134
- solutions, polymer. *See* polymer solutions
- spectroscopic methods, copolymers
  - composition determination, 33–35
- step polymerisation, 56–58
  - examples, 58–59
  - prepolymers, 58–59
  - small reagents, 58–59
- stereoisomerism, 13–16
  - cis-trans* isomerism, 15–16
  - optically active polymers, 15
  - polypropylene, 14
- sterilisation of polymers, 99–100
- structure of polymers, cohesion of materials, 44, 44–48
- surface properties
  - polymers, 1–2
  - properties of polymers as materials, 50–53, 52
- suspension polymerisation, 76, 77
- sutures, biodegradable/bioerodible polymers, 91–98
- synthesising polymers, need for, 55–56
- synthetic methods, 66–73
  - anionic chain polymerisation, 67–71
  - cationic chain polymerisation, 71–73
  - free radical chain polymerisation, 59–64
  - step polymerisation, 56–58
- tableting, excipients, 155–116
- therapeutic embolisation, biomedical uses of polymers, 111–114
- thermal properties determination, polymers, 30–31
- thermal properties, coating applications, pharmaceutical use, 130
- tissue compatibility, biomedical uses of polymers, 102–103
- toxicity, biocompatibility, 100–101
- uses, polymers, 1–2
- viscosity, molecular weight determination, 28–30
- water vapour permeability
  - coating applications, pharmaceutical use, 125–131