

bookboon.com

Pharmacokinetics

Philip Rowe



Download free books at

bookboon.com

Philip Rowe

Pharmacokinetics

Pharmacokinetics

© 2012 Philip Rowe & Ventus Publishing ApS

ISBN 978-87-403-0090-1

Contents

| | | |
|----------|--|-----------|
| | Introduction | 9 |
| 1 | ADME and Pharmacokinetics | 10 |
| 1.1 | ADME – Absorption Distribution, Metabolism and Excretion | 10 |
| 1.2 | Pharmacokinetics | 11 |
| 2 | Absorption: Absorption rate constant, Bioavailability and Salt factor | 13 |
| 2.1 | Passive diffusion and other mechanisms by which drugs may cross biological membranes | 13 |
| 2.2 | Rate of drug absorption and the Absorption rate constant (Ka). | 17 |
| 2.3 | Bioavailability | 18 |
| 2.4 | Salt factor | 23 |
| 3 | Distribution: Compartments and Volume of Distribution | 24 |
| 3.1 | The rate of distribution and compartments | 24 |
| 3.2 | One compartment model | 25 |
| 3.3 | Two compartment model | 25 |
| 3.4 | The extent of distribution | 27 |
| 3.5 | Volume of distribution | 31 |
| 3.6 | Using the volume of distribution to calculate dose size | 35 |
| 3.7 | Practice calculations | 36 |

Please click the advert

A collage of images showing office workers and a building at night, overlaid with a blue wave graphic. The collage includes a person working at a computer, a man holding a folder, and two women talking. The background features a building at night and a blue wave graphic.

www.job.oticon.dk

oticon
PEOPLE FIRST

Download free ebooks at bookboon.com

| | | |
|-----------|---|-----------|
| 4. | Elimination: Elimination rate constant, half-life and clearance | 38 |
| 4.1 | Elimination rate constant and half-life | 38 |
| 4.2 | Clearance | 42 |
| 4.3 | Practice calculations | 46 |
| 5 | Single intravenous bolus injection into one compartment | 47 |
| 5.1 | Concentration versus time graph | 48 |
| 5.2 | Relationship between time and concentration | 49 |
| 5.3 | Area Under the Curve (AUC) | 52 |
| 5.4 | Practice calculations | 54 |
| 5.5 | Appendix 1 | 54 |
| 5.6 | Appendix 2 | 54 |
| 6 | Analysis of experimental data from a bolus i.v. injection into one compartment | 56 |
| 6.1 | Analysis of clinical trials data | 57 |
| 6.2 | Analysis of data arising in a clinical setting | 61 |
| 6.3 | Practice calculations | 62 |
| 6.4 | Appendix 1 | 64 |
| 6.5 | Appendix 2 | 66 |
| 7 | Single intravenous bolus injection into two compartments | 67 |
| 7.1 | The model to be considered | 67 |
| 7.2 | Drug concentrations in blood and the rest of the first compartment | 67 |

Please click the advert

01001001 01010100
 00100000 01010100
 01110010 01100001
 01101001 01101110
 01100101 01100101

Sie sehen hier mehr als Nullen und Einsen?

Wir sehen Ihre Karriere im IT-Trainee-programm. Als spätere Fach- oder Führungskraft.

www.perspektiven.allianz.de

Allianz Karriere

Allianz 

| | | |
|----------|---|-----------|
| 7.3 | Determining how many compartments a drug occupies | 69 |
| 7.4 | Drug concentration in the second compartment | 70 |
| 7.5 | Two compartment systems and therapeutic drug monitoring for digoxin | 71 |
| 8 | Constant intravenous infusion | 73 |
| 8.1 | The model to be considered | 73 |
| 8.2 | Concentration versus time curve during infusion | 73 |
| 8.3 | Relationship between rate of infusion and concentration at steady state | 74 |
| 8.4 | Loading doses | 75 |
| 8.5 | The accumulation period | 80 |
| 8.6 | Practice questions | 82 |
| 8.7 | Appendix | 82 |
| 9 | Extravascular administration | 83 |
| 9.1 | The situation to be considered | 83 |
| 9.2 | Concentration versus time curve | 83 |
| 9.3 | Changing the rate of absorption | 85 |
| 9.4 | C _{max} and T _{max} | 86 |
| 9.5 | Determination of bioavailability for extravascular doses. | 86 |
| 9.6 | Trapezoidal rule – A practical method to measure AUC | 89 |
| 9.7 | Practice question | 92 |
| 9.8 | Appendix | 93 |

Please click the advert

Turning a challenge into a learning curve. Just another day at the office for a high performer.

Accenture Boot Camp – your toughest test yet

Choose Accenture for a career where the variety of opportunities and challenges allows you to make a difference every day. A place where you can develop your potential and grow professionally, working alongside talented colleagues. The only place where you can learn from our unrivalled experience, while helping our global clients achieve high performance. If this is your idea of a typical working day, then Accenture is the place to be.

It all starts at Boot Camp. It's 48 hours that will stimulate your mind and enhance your career prospects. You'll spend time with other students, top Accenture Consultants and special guests. An inspirational two days

packed with intellectual challenges and activities designed to let you discover what it really means to be a high performer in business. We can't tell you everything about Boot Camp, but expect a fast-paced, exhilarating

and intense learning experience. It could be your toughest test yet, which is exactly what will make it your biggest opportunity.

Find out more and apply online.

Visit [accenture.com/bootcamp](https://www.accenture.com/bootcamp)

• Consulting • Technology • Outsourcing

High performance. Delivered.

| | | |
|-----------|--|------------|
| 10 | Multiple dosing | 94 |
| 10.1 | Pharmacokinetic accumulation and steady state | 94 |
| 10.2 | Multiple extravascular doses | 96 |
| 10.3 | Concentrations at steady state | 96 |
| 10.4 | Loading dose | 101 |
| 10.5 | Accumulation stage | 102 |
| 10.6 | Extent of fluctuation in drug concentrations | 103 |
| 10.7 | Practice questions | 107 |
| 10.8 | Appendix | 108 |
| 11 | Non-linear pharmacokinetics | 110 |
| 11.1 | Considering drug metabolism as an enzyme catalysed reaction | 110 |
| 11.2 | Exceptions to linearity | 112 |
| 11.3 | Effect of non-linearity on the relationship between dose and drug concentration. | 113 |
| 11.4 | Clinical significance of non-linear kinetics | 114 |
| 11.5 | Non-linear kinetics and drug development | 115 |
| 12 | Non-compartmental pharmacokinetics | 116 |
| 12.1 | The case for non-compartmental methods | 116 |
| 12.2 | Calculation methods | 116 |
| 12.3 | More complex situations | 118 |

Please click the advert



Join the Vestas Graduate Programme

Experience the Forces of Wind and kick-start your career

As one of the world leaders in wind power solutions with wind turbine installations in over 65 countries and more than 20,000 employees globally, Vestas looks to accelerate innovation through the development of our employees' skills and talents. Our goal is to reduce CO₂ emissions dramatically and ensure a sustainable world for future generations.

Read more about the Vestas Graduate Programme on vestas.com/jobs.
Application period will open March 1 2012.

Wind. It means the world to us.™

Download free ebooks at bookboon.com

| | | |
|-----------|--|------------|
| 13 | Computerized analysis of pharmacokinetic data | 119 |
| 13.1 | Least squares fitting | 119 |
| 13.2 | Practice question | 124 |
| 14 | Creatinine clearance | 125 |
| 14.1 | Clearance of creatinine and various drugs | 125 |
| 14.2 | Digoxin dosing | 127 |
| 14.3 | Practice questions | 129 |
| | Pharmacokinetic symbols and equations | 130 |
| | Symbols | 130 |
| | Cockcroft and Gault equations | 132 |
| | Additional material available from the internet | 133 |
| | Answers to practice questions | 134 |
| | Chapter 3 | 134 |
| | Chapter 4 | 135 |
| | Chapter 5 | 137 |
| | Chapter 6 | 138 |
| | Chapter 8 | 140 |
| | Chapter 9 | 142 |
| | Chapter 10 | 143 |
| | Chapter 13 | 146 |
| | Chapter 14 | 146 |

Please click the advert



it's an **interesting** world

Get under the skin of it.

Graduate opportunities
Cheltenham | £24,945 + benefits

One of the UK's intelligence services, GCHQ's role is two-fold: to gather and analyse intelligence which helps shape Britain's response to global events, and, to provide technical advice for the protection of Government communication and information systems. In doing so, our specialists – in IT, internet, engineering, languages, information assurance, mathematics and intelligence – get well beneath the surface of global affairs. If you thought the world was an interesting place, you really ought to explore our world of work.

www.careersinbritishintelligence.co.uk

Applicants must be British citizens. GCHQ values diversity and welcomes applicants from all sections of the community. We want our workforce to reflect the diversity of our work.



Introduction

Pharmacokinetics describes, in a quantitative manner, the passage of drugs through the body. A series of distinctive parameters such as bioavailability, volume of distribution and clearance are used to describe:

- The rate and extent of drug absorption into the blood stream
- The rate and extent of drug movement out of blood into the tissues
- The rate of drug removal from the body

These parameters can then be used to predict the blood concentration of drug that will arise with any given dosage regime.

A diverse range of students will have some exposure to PKs.

- For clinically oriented students – medicine, pharmacy etc – the main interest will be in calculating dosage regimes for individual patients.
- Basic science students – pharmacology, pharmaceutical sciences etc – need to understand the uses that clinicians make of pharmacokinetic concepts, but they will also need to appreciate why determining the kinetic properties of a new drug or formulation is so important in the drug development process.

Most of the topics covered will be relevant to both drug development and clinical practice, but the introduction to each chapter will indicate the area(s) of relevance for the material.

This book is designed to introduce the basic concepts of pharmacokinetics. One of its key emphases is to explain the physical meaning of the various kinetic parameters – What do bioavailability, volume of distribution, clearance etc actually tell us about the behaviour of a drug?

Key equations are highlighted (inset and italicised) as below.

$$C_{ss} = (F.D) / (Cl.\tau)$$

Placing derivations of these equations in the main text would distract from the principle theme, so these are presented in an appendix at the end of the relevant chapter. A list of symbols and key equations is provided towards the end of the book.

Most chapters include some example calculations for you to try. The answers are placed in a separate section at the end of the book.

Key-points are highlighted in key boxes, as shown below:

| | |
|---|--|
|  | A 'Compartment' is a collective term for all those areas of the body into which a drug distributes at approximately the same rate. |
|---|--|

Additional material, relevant to this book, is available from the 'Pharmacokinetics' page of www.phrData.co.uk

Download free ebooks at bookboon.com

1 ADME and Pharmacokinetics

In this chapter we will define the areas that are to be covered by this book and explain their practical significance.

1.1 ADME – Absorption Distribution, Metabolism and Excretion

Drugs are handled by the body in three stages: Absorption, distribution and elimination.

1.1.1 Absorption

Absorption is the process by which a drug moves from its site of application into the blood stream. This process arises in all forms of drug use apart from:

- Intravenous injection: Here the drug is administered directly into the blood and consequently this route has several special pharmacokinetic properties, including this lack of any absorption stage.
- Topical application: Here the drug is applied directly to the intended site of action and absorption into the blood stream is unnecessary. However, it is as well to remember that while absorption may not be intended, in many cases it does still arise and the drug may have effects throughout the body; corticosteroids in asthma inhalers are targeted for a topical effect within the lungs, but absorption into the rest of the body will still arise to some extent.

It might be thought that no absorption stage is required with intramuscular (i.m.) or subcutaneous (s.c.) injection as the drug has already been deposited into the body. However, we do not consider a drug to have been absorbed until it reaches the blood, so even an i.m. or s.c. dose needs to undergo absorption into the blood.

1.1.2 Distribution

The next phase of drug handling is distribution. This refers to the movement of drug backwards and forwards between blood and the various tissues of the body. This is illustrated in Fig.1.1. Three tissues have been indicated as examples, but the real situation is much more complex, with many different tissues involved.

Notice that we assume all movement from one tissue to another occurs exclusively via the blood. So, if drug is to move from muscle to the liver, then it will do so by moving from the muscle into the bloodstream, then the blood travels to the liver and discharges the drug into that organ. Exceptions to this rule are rare – for example, following oral administration, very lipid soluble drugs may be absorbed into the lymphatic system, which then acts as the transport medium.

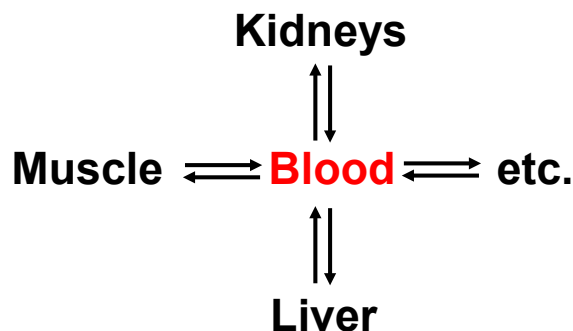

Figure 1.1: The process of drug distribution.

1.1.3 Elimination

‘Elimination’ is a general term referring to drug removal from the body by any mechanism. A sharp distinction is drawn between two different forms of elimination:

Excretion: This is the simple removal of the intact drug molecule from the body. If a patient is treated with the aminoglycoside antibiotic gentamicin, most of the dose will reappear in the urine in an unchanged form and this is a true example of excretion.

Metabolism: Here the drug is destroyed by chemical alteration. The metabolites will then probably be disposed of in the urine or bile, but this overall process is referred to as ‘metabolism’ not ‘excretion’. The latter term is restricted to those cases where the drug is eliminated unchanged. Following a dose of a drug such as theophylline, very little unchanged drug will be present in the urine – the vast majority is metabolized.

It is because of this sharp distinction between two different forms of elimination, that we normally refer to the ‘ADME’ of a drug – its Absorption, Distribution, Metabolism and Excretion.

| | |
|---|---|
|  | Absorption Distribution Metabolism Excretion |
|---|---|

1.2 Pharmacokinetics

The term ‘Pharmacokinetics’ refers to the mathematical modelling of the rate and completeness of the four components of ADME in order to be able to predict blood levels of drug that would arise from any defined dosage regimen.

The practical value of pharmacokinetics rests on an assumption that drug effect depends upon blood concentrations of drug. We assume (correctly in most cases) that as drug levels rise we will see three phases

- Too low – drug is ineffective
- Acceptable – drug becomes effective but the risk of side-effects remains tolerably low
- Too high – Risk of side-effects becomes excessive.

This is summarized in Fig. 1.2.

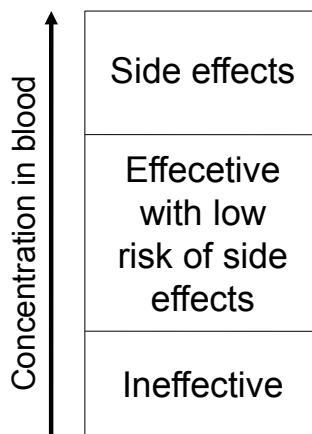

Figure 1.2: Assumed relationship between blood drug concentrations and drug effect.

There are two main areas where pharmacokinetics is of practical value – drug development and clinical practice:

1.2.1 Pharmacokinetics and drug development

If a drug company is hoping to market a new molecular entity or a new dosage form of an existing product, they need to be confident that it will be possible to devise a dosing regimen that will be convenient, effective and safe. The ideal would be a product that can be administered once daily as oral tablets or capsules and that this will provide blood levels that remain comfortably within the ideal zone - high enough to be effective, but well short of producing side-effects. It is not always possible to achieve precisely this ideal, but any drug company would prefer to avoid a product that has to be administered several times a day or where blood levels are constantly teetering on the verge of ineffectiveness and/or toxicity. Experimental work to identify pharmacokinetic problems will take place very early in the development cycle, so that candidate products with serious pharmacokinetic problems can be terminated before too great a wastage of resources.

1.2.2 Clinical pharmacokinetics

Once a product has come to market, doctors and pharmacists etc may need to devise dosing schemes that are tailored to the needs of individual patients. Typically, this might involve calculating a dose size and a dosing interval (how often doses are taken). This may need to take account of patients' weights and ages, their renal and liver function, whether they smoke etc. A knowledge of pharmacokinetics is essential for dosage calculation.

This book will refer to issues that are relevant to both drug development and clinical practice.

2 Absorption: Absorption rate constant, Bioavailability and Salt factor

In this chapter we will consider the first stage of ADME – the entry of the drug into the blood stream. All the content of this chapter is relevant to both drug development and clinical practice.

2.1 Passive diffusion and other mechanisms by which drugs may cross biological membranes

Assuming a drug is not injected intravenously, it will have to cross biological membranes in order to reach the blood from its initial site of application (within the gastrointestinal tract if oral or within a muscle or under the skin if intramuscular or subcutaneous etc). In the next sections, we review the mechanisms by which drugs may cross (or be prevented from crossing) membranes.

2.1.1 Passive diffusion

Much the commonest mechanism by which drugs cross biological membranes is passive diffusion. This is shown in Figure 2.1. The drug is travelling left to right, beginning and ending in aqueous environments that are separated by a biological membrane. These membranes contain some proteins, but are primarily lipid in nature. The drug molecule starts (a) in the aqueous solution to the left of the membrane. There is no mechanism to direct the molecule to move in any specific direction; it simply wanders around randomly. At some point it happens to arrive at the interface between its current water environment and the lipid of the membrane. Here it may partition out of the aqueous phase into lipid solution within the membrane (b). It now continues its random wandering and may eventually reach the interface with the aqueous environment on the right, at which point it can partition back into aqueous solution (c).

Notice that the molecule effectively dissolves its way through the lipid membrane. The only driving force for movement is a concentration gradient. Given equal concentrations of drug on both sides of the membrane, there will be equal amounts of drug moving left-to-right and back again, with no net movement in either direction. Only when there is a higher concentration on the left hand side, will we see net movement as indicated in Fig 2.1.

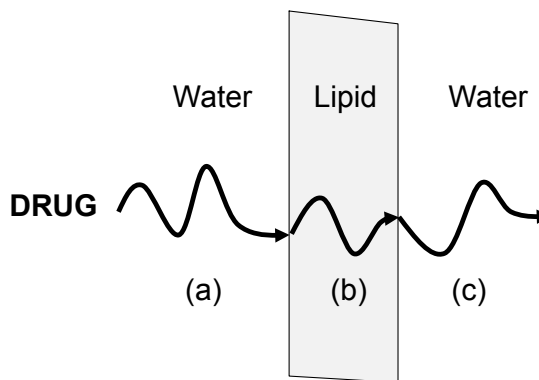

Figure 2.1: The mechanism of passive diffusion.

As the molecule has to spend some time in aqueous solution and some in the lipid phase, there are two requirements for this process to occur efficiently. It requires both:

- Aqueous solubility
- Lipid solubility

The commonest source of problems with passive diffusion is inadequate lipid solubility. This generally arises with molecules that are polar (carry electrical charges) and are therefore readily water soluble, but cannot partition into the lipid phase of the membrane.

Please click the advert

Brain power



By 2020, wind could provide one-tenth of our planet's electricity needs. Already today, SKF's innovative know-how is crucial to running a large proportion of the world's wind turbines.

Up to 25 % of the generating costs relate to maintenance. These can be reduced dramatically thanks to our systems for on-line condition monitoring and automatic lubrication. We help make it more economical to create cleaner, cheaper energy out of thin air.

By sharing our experience, expertise, and creativity, industries can boost performance beyond expectations. Therefore we need the best employees who can meet this challenge!

The Power of Knowledge Engineering

Plug into The Power of Knowledge Engineering.
Visit us at www.skf.com/knowledge





Most drugs can only cross membranes by passive diffusion and their ability to do this depends upon their lipid solubility. Excessively water soluble drugs are likely to be unable to cross membranes.

Drug companies generally prefer to develop potential drug molecules that are reasonably lipid soluble. Excessively water soluble ones may be incapable of absorption following oral administration and therefore need to be injected.

2.1.2 Facilitated diffusion and active transport

Where drugs undergo facilitated diffusion or active transport, there is a transporter protein that binds the drug molecule and carries it across the membrane. In this case the drug does not have to dissolve in the lipid membranes and there is no requirement for lipid solubility. This is shown in Fig 2.2. With facilitated diffusion the carrier enables drug movement in either direction, but there is no active mechanism to pump drug in either direction. As with passive diffusion, net movement requires a concentration gradient to drive it. In contrast, active transport is an energy requiring, active process which pumps drug in a defined direction. In that case, net transport is possible under any circumstances, even occurring against a concentration gradient.

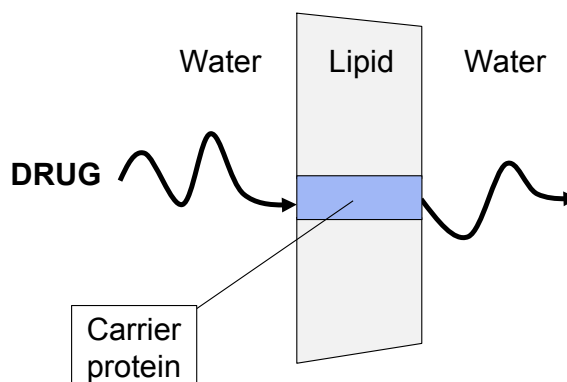

Figure 2.2: The mechanism of facilitated diffusion or active transport.

The transporter molecules that carry out facilitated diffusion and active transport are very selective; they will only bind to and transport, tightly defined groups of molecules. They have obviously arisen during evolution, to carry naturally occurring molecules across membranes. The vast majority of man-made drugs are chemically distinct from these natural substrates and consequently there are no carriers to which they can bind. Hence, the only mechanism by which most drugs can cross membranes is passive diffusion. Man-made drugs that are sufficiently similar to natural substrates and able to 'hitch a ride' on an existing carrier, include levodopa and gabapentin. These resemble the naturally occurring amino acids and can be carried by the Large neutral Amino acid Transporter (LAT1).

Table 2.1 summarizes the characteristics of passive diffusion, facilitated diffusion and active transport

| | Passive diffusion | Facilitated diffusion | Active transport |
|--|---|--|--|
| Uses a carrier protein? | No | Yes | Yes |
| Requirements for a molecule to undergo this process | Non-specific. Just needs to be adequately lipid soluble. | Very specific. Molecule must fit a natural transporter molecule | Very specific. Molecule must fit a natural transporter molecule |
| Commonly used by man-made drugs? | Yes | No | No |
| Energy requiring? | No | No | Yes |
| Requirements for net movement in a specified direction | A suitable concentration gradient must exist. | A suitable concentration gradient must exist. | Movement can occur with or against a concentration gradient. |

Table 2.1 Properties of passive diffusion, facilitated diffusion and active transport.

2.1.3 P-glycoproteins

The lining cells (epithelium) of the gut contains P-glycoproteins. These are located within that part of the membrane of the epithelial cells that is in direct contact with the gastrointestinal contents (the ‘Apical’ surface). A drug molecule (represented as the solid black square in Figure 2.3) is assumed to be adequately lipid soluble to undergo passive diffusion and enter the epithelial cell. However, the P-glycoprotein then binds the drug and expels it back into the gut contents, thus inhibiting its absorption. In this way, fat soluble molecules that would be expected to be readily absorbed, may in fact be much less efficiently taken up. A range of drugs from widely separated therapeutic areas and with quite different chemical structures are subject to P-glycoprotein efflux. These include ciclosporin, verapamil and dexamethasone.

| | |
|---|---|
|  | <p>P-glycoproteins may inhibit the absorption of lipid soluble drugs that would otherwise be freely absorbed from the gastrointestinal tract.</p> |
|---|---|

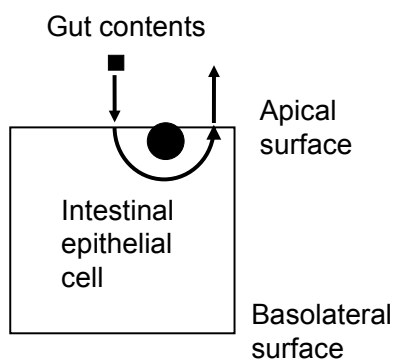

Figure 2.3 Effect of P-glycoproteins on drug absorption from the gastrointestinal tract

2.2 Rate of drug absorption and the Absorption rate constant (Ka).

The speed at which the various processes within ADME occur are described by a series of rate constants. The usual assumption is that the rate of ADME processes can be described as 'First order'. This means that there is a simple proportionality between the rate at which the process goes ahead and the mass of drug waiting to undergo that process. Putting this into a more formal equation:

Rate of process = Mass of drug available x Constant

Based on this relationship, if there is twice as much drug available, the process will occur twice as fast.



It is generally assumed that pharmacokinetic processes take place at a rate that is directly proportional to the mass of drug available to undergo that process. i.e. They are considered first order.

Where the specific process in question is drug absorption, the relevant constant is the Absorption rate constant (Ka) and the relationship is:

Rate of absorption = Mass of drug available for absorption x Ka

If a drug is being given orally, then it follows that the rate at which drug is absorbed will depend on the mass of drug in the gut available for absorption and upon Ka.

Please click the advert

See the light!
The sooner you realize we are right,
the sooner your life will get better!

A bit over the top? Yes we know!

We are just that sure that we can make your media activities more effective.



Get "Bookboon's Free Media Advice"
 Email kbm@bookboon.com



CREDIT SUISSE

DAIMLER



Microsoft

bookboon.com

The value of K_a is not simply a fixed value for each drug entity; it depends upon the dosage form. Theophylline contained in a simple tablet will be absorbed more rapidly than the same drug in a slow release formulation.

K_a is a parameter that would be of interest in industrial pharmacokinetic studies undertaken as part of drug development; it is unlikely that the value of K_a would ever be used in the practical calculation of a dosage regimen within clinical practice.

2.3 Bioavailability

2.3.1 Definition of bioavailability

Apart from the rate of a drug's absorption, we also need to consider the completeness of its absorption. Bioavailability is used to report this and it is defined below as:

| | |
|---|--|
|  | <p>Bioavailability: The proportion of an administered dose that is absorbed chemically unchanged into the systemic blood circulation.</p> |
|---|--|

The first thing to note is that bioavailability is reported as a proportion. So, if a quarter of the administered dose eventually gets into the circulation, its bioavailability could be quoted as 0.25 or 25%. Either value is perfectly acceptable, but notice that in any pharmacokinetic calculation where a value for bioavailability has to be incorporated, it must be in the decimal form (0.25, not 25).

The second point about the definition is the inclusion of the term 'chemically unchanged'. This would be especially important with an oral dose of drug, where part of the dose may be chemically degraded during the absorption process and thus we absorb a mixture of authentic, active drug and breakdown products. Only the unchanged material is considered as bioavailable.

Finally, the definition requires the drug to reach the 'systemic blood circulation'. What this means is the general or well-mixed circulation, not some obscure backwater. The requirement for this term will be more obvious, once we have considered oral bioavailability in more detail (next section).

Bioavailability is sometimes called 'Fractional availability' and consequently it is represented in pharmacokinetic calculations as 'F'.

2.3.2 Bioavailability from the iv and oral routes

We have already seen that iv injection is special, as it is the only route where no absorption stage is required. As a result of direct application of the dose straight into the blood stream, i.v. administration is also special in being the only route where the entire dose is guaranteed to reach the blood stream i.e. bioavailability must be 1.0 or 100%. For all other routes, there is the potential for incomplete absorption; bioavailability may in practice be 100%, but this can never be guaranteed in the same way that it can with the i.v. route.

| | |
|---|---|
|  | <p>Bioavailability from the i.v. route is automatically 100%. For other routes, F may in practice be 100%, but this cannot be guaranteed.</p> |
|---|---|

Unfortunately, the most commonly used route of drug administration, the oral route, presents the greatest number of obstacles to bioavailability. Figure 2.4 summarizes the potential problems.

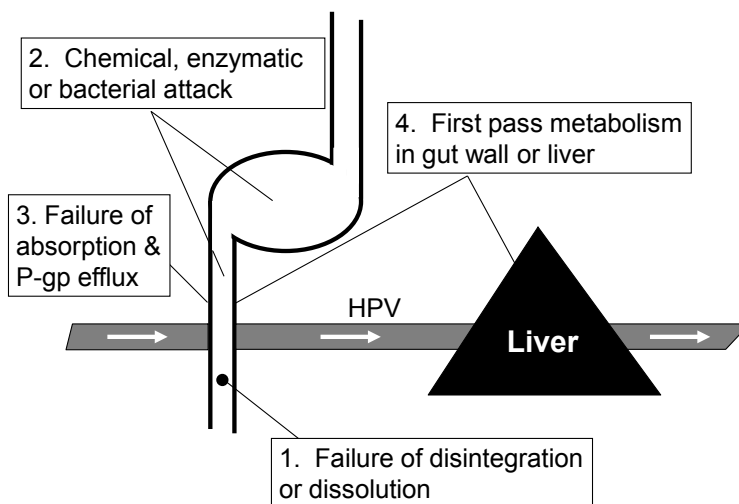

Figure 2.4 Mechanisms which may cause oral bioavailability to be incomplete

Figure 2.4 shows the oesophagus, stomach and intestine. The drug is assumed to be in a solid dosage form (tablet or capsule) that has not yet disintegrated and is shown as a solid black circle in the intestine. The figure also shows blood entering the tissue of the gut via an artery on the left and exiting to the right. This blood does not then follow the pattern seen in most tissues (returning to the right heart), but instead it flows through the liver. Blood exiting the liver finally does the normal thing - flows directly back to the heart. The vessel connecting the gut to the liver is neither an artery nor a vein; it is a 'portal vessel' (The Hepatic Portal Vessel – HPV in Fig 2.4).

The first potential cause of incomplete bioavailability is that the dosage form may fail to disintegrate and/or allow the active ingredient to dissolve fully. With good formulation, this should not arise, but it needs to be born in mind as a possible problem.

Secondly, there may be breakdown of the active ingredient within the gastrointestinal contents. Three possibilities are particularly obvious:

- Chemical: The stomach may have a pH as low as 1.0 and some molecules simply cannot withstand this extreme acidity. Without a special enteric coated formulation, such a drug will not be fully orally bioavailable.
- Enzymatic: The Gastro-Intestinal Tract (GIT) contains many digestive enzymes. Any attempt to administer insulin orally, would be doomed to failure, as proteases would digest it.

- Bacterial: The upper parts of the gut (stomach and small intestine) are normally virtually sterile, so attack by bacteria will not be a problem, so long as the drug is absorbed rapidly enough to have left the gut by the time the GIT contents reach the colon. However, a relatively polar drug such as digoxin is absorbed rather inefficiently and it is likely that a significant part of the dose will still be present when the GIT contents reach the colon. Then the extensive colonic flora will have an opportunity to degrade part of the dose.

Thirdly, we have the possibility of incomplete absorption into the blood stream. This is most likely with polar drugs that are very water soluble and lack the required lipid solubility to be efficiently absorbed by passive diffusion. Absorption may also be inhibited by P-glycoprotein efflux (Section 2.1.3). Occasionally absorption may be inhibited by binding of a drug to some other component within the gastrointestinal tract; a classic example being the binding of tetracycline to polyvalent cations (such as Ca⁺⁺ in milk), leading to non-absorption of the antibiotic.

Finally, even if a drug molecule survives all these hazards and is absorbed chemically intact into the hepatic portal vessel, it may yet be metabolically eliminated during passage through the liver and never reach the general circulation. Any drug that is metabolized in this way will never be able to exert its pharmacological effect in the body and is not considered to be bioavailable. Such losses are referred to as 'First pass metabolism'.



First pass metabolism:

When a drug is metabolized **before it ever reaches the systemic circulation.**

Trust and responsibility

NNE and Pharmaplan have joined forces to create NNE Pharmaplan, the world's leading engineering and consultancy company focused entirely on the pharma and biotech industries.

Inés Aréizaga Esteva (Spain), 25 years old
Education: Chemical Engineer

- You have to be proactive and open-minded as a newcomer and make it clear to your colleagues what you are able to cope. The pharmaceutical field is new to me. But busy as they are, most of my colleagues find the time to teach me, and they also trust me. Even though it was a bit hard at first, I can feel over time that I am beginning to be taken seriously and that my contribution is appreciated.

Please click the advert



NNE Pharmaplan is the world's leading engineering and consultancy company focused entirely on the pharma and biotech industries. We employ more than 1500 people worldwide and offer global reach and local knowledge along with our all-encompassing list of services.
nnepharmaplan.com

nne pharmaplan®

The key part of the definition is 'before it ever reaches the systemic circulation'. A drug molecule that enters the general circulation and is then metabolized is not considered to have undergone first pass metabolism as it has spent some time in the general circulation and has had an opportunity to exert its therapeutic effect. You should now appreciate why the term 'systemic blood circulation' is incorporated into the definition of bioavailability given in Section 2.3.1 – a drug's arrival in the hepatic portal vessel does not necessarily constitute bioavailability.

The liver is not the only place where first pass metabolism may occur. During absorption, drug molecules must pass through the epithelial cells of the gut and these cells contain the same sort of drug metabolizing enzymes that are found in the liver. Consequently, first pass metabolism can also occur in the lining of the gut.

Table 2.2 shows average oral bioavailability values for a variety of drugs. The list generally focuses on drugs with problematically low bioavailabilities as these are of special interest. In fact a wide range of drugs do have oral bioavailabilities of 100% (or very nearly so).

| Drug | Oral bioavailability (%) |
|-------------|--------------------------|
| Gentamicin | <5 |
| Verapamil | 22 |
| Lidocaine | 35 |
| Propranolol | 36 |
| Digoxin | 75 |
| Phenytoin | 98 |
| Valproate | 100 |

Table 2.2 Average oral bioavailability values for a selection of drugs.

There are a variety of reasons why some of these compounds have limited bioavailability. Gentamicin (and all the other aminoglycosides) has a very high water solubility and inadequate fat solubility to undergo passive diffusion. It is virtually unavailable orally and has to be given by injection. Verapamil, lidocaine and propranolol are all subject to extensive first pass metabolism and additionally, the absorption of verapamil is inhibited by p-glycoprotein efflux. The bioavailability of digoxin is compromised by its rather low lipid solubility. This is not as extreme as that of gentamicin, but absorption is still slow and inefficient. This leads to incomplete absorption and some of the dose will remain in the gut long enough to arrive in the colon where bacterial attack can occur.

2.3.3 Buccal/sublingual and rectal administration and hepatic first pass metabolism

In Figure 2.4, blood draining from the gut was shown as passing through the liver before joining the general circulation. This pattern holds true for the majority of the gastrointestinal tract, but not for its two extreme ends – the mouth and the lower part of the rectum. Figure 2.5 shows the complete picture.

If a drug is absorbed from either end of the tract, blood carrying the drug will leave the GIT and join directly with the general circulation without passing through the liver; the problem of drug loss due to first pass metabolism in the liver is then averted. Absorption from the mouth may be achieved if drugs are administered as sublingual (held under the tongue) or buccal (held between the teeth and the cheek) formulations. Practical experience does show that bioavailability can be usefully improved by this approach. The only problem is ensuring that the patient does not swallow the preparation, in which case all potential advantage is lost. Attempting to achieve the same outcome by rectal administration is associated with significant problems. The suppository must be come to lie in the correct (lower) part of the rectum, if any advantage is to be gained. That problem is compounded by the fact that the position at which the rectum divides into the portion which drains to the hepatic portal vessel and that which drains directly to the general circulation, varies between patients and in some the lower portion with the special circulation can be rather short.

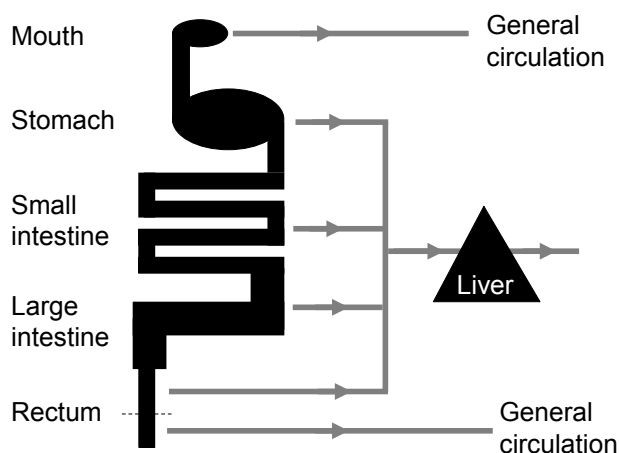

Figure 2.5 Blood drainage from the complete length of the gastro-intestinal tract

2.3.4 Significance of bioavailability in clinical practice and drug development

In clinical practice, knowledge of the bioavailability of a drug is obviously important for dose calculation. If we administer a dose of drug (D) to a patient, but do so via a route for which bioavailability = F , the actual amount delivered will be:

$$\text{Delivered drug} = D \times F$$

In drug development, a high oral bioavailability is desirable. The main problem with low bioavailability is the potential for inter-individual variation. If a drug has an average oral bioavailability of (say) 98%, then individual patients will have values scattered around this figure, with most values in the high 90s and very few patients likely to show values less than 90%. With bioavailability values of 90-100%, we are faced with only 10% variability which is unlikely to cause any practical problems. However, if the mean availability is only 40%, individual values could easily be as low as 30% or as high as 60%. We now have a situation where the same oral dose of drug will deliver twice as much drug to one patient as another. A discrepancy as large as this is likely to make dose optimization for individual patients a complex process and the product will be less attractive to medical practitioners.

2.4 Salt factor

In addition to bioavailability, dose calculations may also need to be adjusted for a so called 'Salt factor'. This arises when a drug is administered as a salt, but our purpose is to deliver a dose defined in terms of mass of parent drug. The salt factor is the proportion of the parent drug contained in the salt, expressed on a weight/weight basis. The symbol 'S' is used to represent the salt factor in pharmacokinetic calculations.

The classic example is theophylline which is likely to be administered as aminophylline. The latter is a complex consisting of theophylline and ethylenediamine. The ethylenediamine is incorporated because the product is more readily water soluble than theophylline. Aminophylline is a somewhat poorly defined salt, but generally contains about 80% theophylline (w/w) and so the salt factor is 0.8. If we want to administer a dose D of theophylline, but will use the drug in the form of aminophylline, we will have to use a dose of:

$$\text{Dose of salt} = D / S$$

Thus, to administer 400mg of theophylline we would need to use $400 \text{ mg} / 0.8 = 500 \text{ mg}$ aminophylline.

Please click the advert

THE MILKWAY
LAUNCHING GRADUATE CAREERS

MILKROUND SYSTEM
Become a business star with internships, placements, graduate jobs & schemes from leading companies.
www.milkround.com

PLANET CAREER ADVICE
Inhabited by insights into business careers and orbited by application advice.

FIRST CONTACT
Get matched to top business employers via intelligent emails landing in your inbox.

Milkround.com: rated the #1 graduate recruitment website in the UK Graduate Careers Survey 2009 of 16,000 university finalists.

Milkround.com

3 Distribution: Compartments and Volume of Distribution

In this chapter we will consider the factors that govern the rate and extent of drug movement between the blood and tissues and introduce a new pharmacokinetic parameter – the Volume of Distribution.

All sections of this chapter are relevant to both drug development and clinical practice.

3.1 The rate of distribution and compartments

Figure 3.1 shows drug passing backwards and forwards between blood and a series of different tissues. It is assumed that drug will distribute into and out of tissues at varying rates; these are indicated by the width of the arrows. In the figure, drug moves most rapidly into Tissues 1 and 2 with Tissue 1 being fastest of all. Movement into Tissues 3 & 4 is slow, with Tissue 4 being slowest.

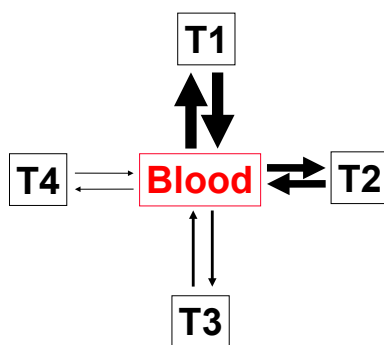



Figure 3.1 Drug moving at varying rates between blood and a series of different tissues.

An exact description of drug handling within the whole body would be immensely complex as it would have to model each tissue separately. To achieve a practically useful model, we make two simplifications. Neither of these is strictly realistic, but they give us access to models that are good enough for practical purposes without undue mathematical complexity. The two simplifications are:

- We allow for just two rates of distribution – ‘Rapid’ and ‘Slow’. All tissues are then assumed to belong to one class or the other. All the slow ones are assumed to permit drug distribution at one fixed (slow) rate and for all other tissues, distribution occurs at a common (rapid) rate.
- For the ‘Rapid’ tissues, we consider movement to be instantaneous; as soon as drug arrives in the blood, it is assumed to spread immediately into all the space provided by the ‘Rapid’ tissues.

For the situation shown in Figure 3.1, blood and Tissues 1 and 2 would be considered as a single space into which drug moves instantly following injection or absorption. Tissues 3 and 4 would form another space into which drug moves at some fixed and relatively slow rate.

The term 'Compartment' is used to describe these aggregations of tissues that are treated as allowing drug to enter at a common rate.

| | |
|---|---|
|  | <p>A 'Compartment' is a collective term for all those areas of the body into which a drug distributes at approximately the same rate.</p> |
|---|---|

3.2 One compartment model

The simplest model allows for instantaneous distribution of drug throughout the blood (and probably to some extent tissues), but this is not then followed by any further slow movement elsewhere. This is shown in Figure 3.2. Drug spreads instantly throughout the blood and Tissues 1 and 2, but never enters other tissues.

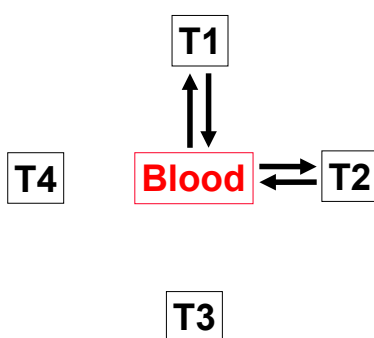

Figure 3.2 Basis of the one compartmental model.

The complete ADME process for the one compartmental situation is usually shown in schematic form as in Figure 3.3. Drug is injected or absorbed into the blood and distributes immediately throughout its range and is eventually eliminated.

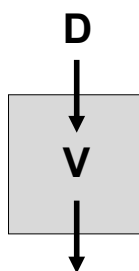

Figure 3.3 Schematic diagram of drug handling with one compartment.

3.3 Two compartment model

Figure 3.4 shows drug behaviour in a two compartment model. Drug is injected or absorbed and spreads instantly throughout the blood and the rapidly equilibrating tissues T1 & T2 (First compartment) and then there is a significant delay while drug enters the rest of the body (Second compartment).

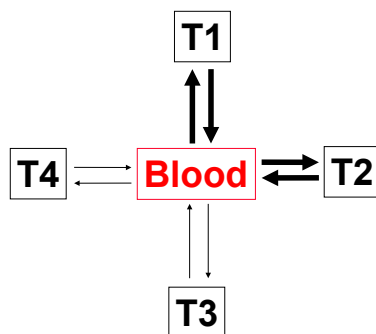

Figure 3.4 Basis of the two-compartmental model

There are two principal factors that can influence the rate at which drugs move in and out of tissues. The first is the polarity of the drug; non-polar drugs undergo passive diffusion easily and so can enter tissues more rapidly than polar ones. The other major factor is blood flow; where tissues have a rich blood supply, drugs can be delivered and removed quickly, whereas significant delay is unavoidable where blood flow is sparse. For many drugs, blood flow is the critical factor, and for the rest of this chapter, we will focus solely on that, but it should be remembered that polarity can be an issue and we will refer to this at a later point.



It is generally assumed that the rate of drug delivery to and removal from, tissues is governed by blood flow.

Please click the advert

“ Top legal people rate The Open University ”

...and some of them are pretty good judges

Raise the bar with top legal courses

Developed in partnership with The College of Law

The College of Law
of England and Wales

Boost your legal career

▶ Find out more

INSPIRING LEARNING



The Open University



| Tissue | Blood flow (mL/min/g) | Broad category |
|--------|-----------------------|-----------------|
| Lung | 10 | Highly perfused |
| Kidney | 4 | |
| Liver | 0.8 | |
| Brain | 0.5 | |
| Fat | 0.03 | Poorly perfused |
| Muscle | 0.025 | |
| Bone | 0.02 | |

Table 3.1 Blood flow to a representative range of tissues.

Table 3.1 shows a spectrum of blood flows measured in mL of blood per minute per gram of tissue. We tend to divide tissues into two broad categories – ‘Highly perfused’ and ‘Poorly perfused’. For most drugs, the tissues shown as highly perfused will approximate the first compartment and the less well perfused ones, the second.

Notice that the two principal drug eliminating organs (Liver and kidney) are both well perfused and therefore form part of the first compartment. When we draw a schematic diagram of a two compartment system, we therefore indicate drug elimination as occurring only from the first compartment.

Figure 3.5 shows drug handling for a two compartment system. Drug is injected or absorbed into the blood (part of the first compartment) and spreads immediately throughout this compartment. There is then slower distribution into the second compartment and from there, back to the first. Elimination is shown occurring exclusively from the first compartment. The second compartment acts as a passive reservoir. The types of tissues forming this compartment (Fat, bone, skin, muscle etc) do not generally significantly metabolize or excrete drugs, so during their stay within this compartment, drugs are unlikely to be eliminated.

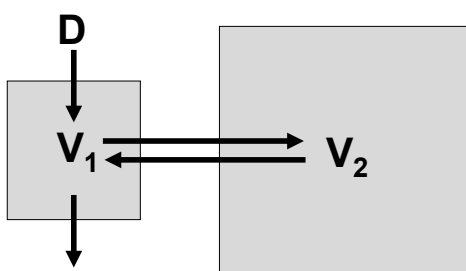

Figure 3.5 Schematic diagram of drug handling with two compartments

3.4 The extent of distribution

In the first part of this chapter, we focused on the **rate** at which drugs enter various parts of the body. In this second section, we are concerned with the **extent** of drug movement (i.e. how much of the dose moves out of the blood into the tissues).

Four factors govern the extent to which drugs move out of the blood into tissues:

1. Ability to undergo passive diffusion
2. Binding to macromolecules
3. P-glycoproteins
4. Ion trapping

3.4.1 Ability to undergo passive diffusion

We have already seen in Chapter 2, that most drugs rely on passive diffusion in order to cross biological membranes and hence undergo absorption into the blood. We also saw that the ability to undergo this process depended primarily upon adequate lipid solubility.

Similar logic applies to distribution from blood to tissues. Very water soluble molecules will undergo passive diffusion inefficiently and distribute from the blood into tissues either slowly (e.g. digoxin) or hardly at all (e.g. gentamicin).

3.4.2 Binding to macromolecules

Drugs cannot undergo passive diffusion while bound to a macromolecule such as a protein or DNA. Take the example of blood albumin, which binds a wide range of drugs. The protein molecule is far too water soluble to undergo passive diffusion. Albumin is much larger than most drug molecules and the physical chemistry of a drug-protein complex is dominated by the protein moiety – it is also water soluble and incapable of undergoing passive diffusion. Consequently drugs that are bound to macromolecules are effectively trapped on one side of a biological membrane, unable to distribute to the other side. Figure 3.6 shows drug movement between blood and tissues and the effect of binding to a macromolecule (such as albumin) in blood.

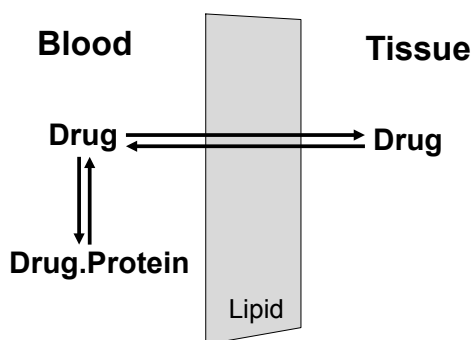

Figure 3.6 Drug distribution between blood and tissue in the presence of binding to a blood protein

Free (unbound) drug molecules are assumed to be lipid soluble and freely able to move in either direction across the lipid membrane. Drug bound to a blood protein is trapped in the blood. At equilibrium, concentrations of free drug will be equal on both sides of the membrane. However, total drug concentration will be higher in the blood because of the additional protein bound material.

Figure 3.7 shows the reverse situation, with binding to intracellular macromolecules. Drug has bound to a protein or nucleic acid or possibly been dissolved into lipid within tissue. The result is the opposite of Figure 3.6; there is now a higher total concentration in the tissues than in blood.

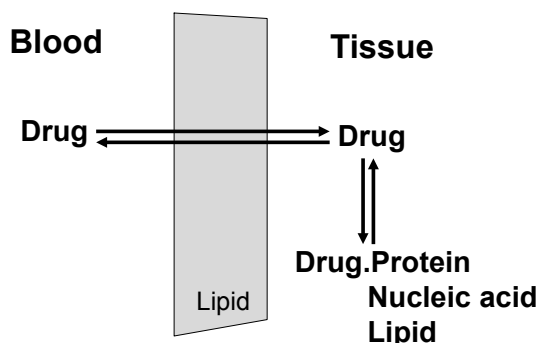

Figure 3.7 Drug distribution between blood and tissue in the presence of binding to a protein etc within tissue

Finally in Figure 3.8, we see what is usually the real situation – binding in both blood and tissues. The outcome will depend upon the relative binding affinity of the blood and intracellular components. For some drugs, plasma binding predominates and the drug will be found primarily in the blood and for others *vice versa*.

Please click the advert



Sharp Minds - Bright Ideas!

Employees at FOSS Analytical A/S are living proof of the company value - First - using new inventions to make dedicated solutions for our customers. With sharp minds and cross functional teamwork, we constantly strive to develop new unique products - Would you like to join our team?

FOSS works diligently with innovation and development as basis for its growth. It is reflected in the fact that more than 200 of the 1200 employees in FOSS work with Research & Development in Scandinavia and USA. Engineers at FOSS work in production, development and marketing, within a wide range of different fields, i.e. Chemistry, Electronics, Mechanics, Software, Optics, Microbiology, Chemometrics.

We offer
A challenging job in an international and innovative company that is leading in its field. You will get the opportunity to work with the most advanced technology together with highly skilled colleagues.

Read more about FOSS at www.foss.dk - or go directly to our student site www.foss.dk/sharpminds where you can learn more about your possibilities of working together with us on projects, your thesis etc.

The Family owned FOSS group is the world leader as supplier of dedicated, high-tech analytical solutions which measure and control the quality and production of agricultural, food, pharmaceutical and chemical products. Main activities are initiated from Denmark, Sweden and USA with headquarters domiciled in Hillerød, DK. The products are marketed globally by 23 sales companies and an extensive net of distributors. In line with the corevalue to be 'First', the company intends to expand its market position.



Dedicated Analytical Solutions

FOSS
 Slangerupgade 69
 3400 Hillerød
 Tel. +45 70103370
www.foss.dk

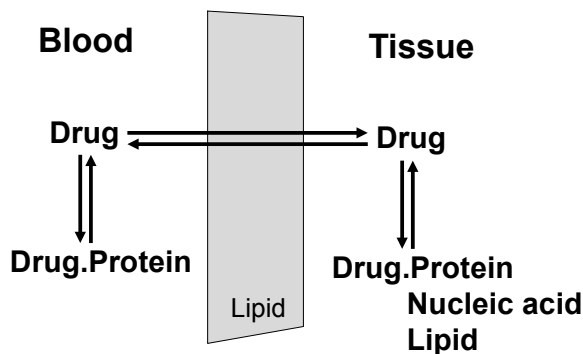

Fig 3.8 Drug distribution between blood and tissue in the presence of binding to macromolecules in both blood and tissues



Binding to macromolecules may hold drug in either blood or the tissues.

3.4.3 P-glycoproteins

In Chapter 2, we saw how P-glycoproteins in the gut can actively pump drugs across membranes and hence inhibit drug absorption. P-glycoproteins are also present in other parts of the body and have an effect upon drug distribution between blood and tissues.

P-glycoproteins seem to have evolved as a mechanism to protect the body from toxic molecules that may be ingested. The central nervous system (CNS) is particularly sensitive to poisoning and one line of defence consists of P-glycoproteins at the blood brain barrier, which prevent the entry of toxins (and certain drugs) into the CNS.

3.4.4 Ion trapping

Ion trapping arises when an ionisable drug encounters a pH gradient. An example is shown in Figure 3.9.

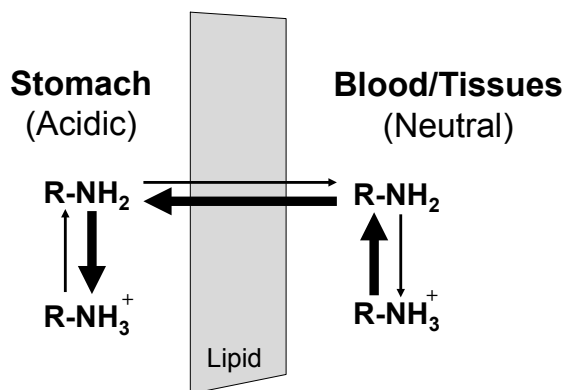

Figure 3.9 Ion trapping of a basic drug in the acidic medium of the stomach

The example in Figure 3.9, assumes that a basic drug contains an ionisable nitrogen atom. The stomach contents are strongly acidic, while blood and tissues are approximately neutral. In its non-ionized form the drug is lipid soluble and able to cross membranes by passive diffusion. However, once ionized it is much more polar and unable to cross.

A sequence of events arises:

- The highly acidic environment within the stomach, causes an extensive shift in the equilibrium between ionized and non-ionized drug towards ionization (Hence the dominant arrow in the appropriate direction).
- The process described above, reduces the concentration of non-ionized drug in the stomach and creates a disequilibrium, with a lower concentration of non-ionized material in the stomach than in the blood. Consequently, non-ionized drug moves into the stomach contents. (See dominant arrow going from blood to stomach.)
- This physical movement depletes the concentration of non-ionized drug in the blood, causing a disequilibrium between ionized and non-ionized drug. This is resolved by re-equilibration - the conversion of ionized into non-ionized drug within the blood. (See final dominant arrow.)

By following the heavy arrows, it can be seen that the overall effect is to transfer drug from the blood into the stomach contents. A practical example of ion trapping is that morphine (an alkaloid) will be found in raised concentrations in stomach contents during an autopsy following overdose.

The opposite effect would be seen with an acidic drug; at equilibrium there would be higher concentrations of drug in the blood than in the stomach. The general rule is a kind of 'attraction of opposites'; acidic drugs accumulate in basic environments and basic drugs in acidic ones.



Attraction of opposites: Ion trapping will cause an accumulation of basic drugs in any relatively acidic environment and *vice versa*.

3.5 Volume of distribution

The four factors discussed above will jointly govern the extent to which drug moves out of blood into tissues. Figure 3.10 summarizes the spectrum of possibilities. The figure represents drug concentration by the degree of shading. In (a), nearly all the drug is retained in the blood with very little moving out into the tissues. In (c), we see the opposite pattern, most of the drug having moved into the tissues. Part (b) represents a more balanced outcome.

The 'Volume of distribution' is the parameter used to describe the behaviour of a particular drug. A situation such as (a) is conveyed by a small volume of distribution and that in (c) by a large value. The volume of distribution is usually represented by the symbol 'V'.



The volume of distribution reflects the tendency of a drug to distribute out of the blood into the tissues. A large volume implies a strong tendency to distribute into the tissues.

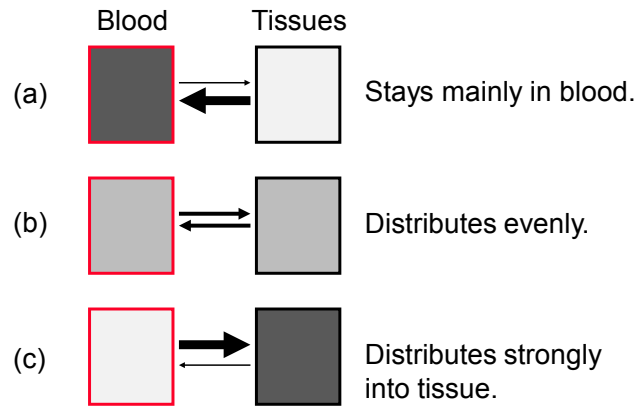

Figure 3.10 The spectrum of possible patterns of distribution for a drug.

The generation of a numerical value for V is explained via Figure 3.11.

Please click the advert

The Wake

the only emission we want to leave behind

[Low-speed Engines](#) [Medium-speed Engines](#) [Turbochargers](#) [Propellers](#) [Propulsion Packages](#) [PrimeServ](#)

The design of eco-friendly marine power and propulsion solutions is crucial for MAN Diesel & Turbo. Power competencies are offered with the world's largest engine programme – having outputs spanning from 450 to 87,220 kW per engine. Get up front! Find out more at www.mandieselturbo.com

Engineering the Future – since 1758.

MAN Diesel & Turbo

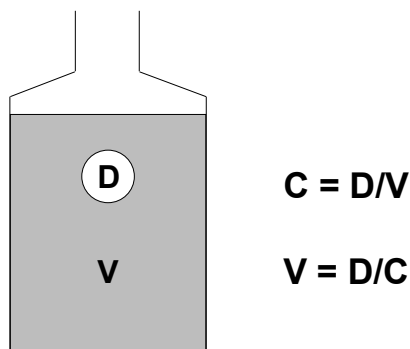

Figure 3.11 The relationship between drug dose, volume and concentration for a bottle or a patient

Start with something simpler than the human body - a bottle. The bottle in Figure 3.11 has a volume of V litres and a dose (D mg) of drug is added and allowed to dissolve and disperse evenly throughout the volume. The resultant concentration (C ; in mg/L) will be:

$$C = D/V$$

In an alternative scenario, we might not know the volume of the bottle, but we could determine this by adding a known dose of drug, stirring and then removing a sample for analysis, to determine drug concentration. We then calculate the volume by re-arranging the previous formula:

$$V = D/C$$

We can perform a similar operation in a patient – inject a known dose of drug, remove a blood sample to determine drug concentration and finally obtain a volume by the same calculation. The value we would obtain by this calculation is the volume of distribution for the drug. A simple example is shown in Figure 3.12. It doesn't matter whether the dose (50mg) was delivered into a bottle or a patient or whether the resultant concentration (0.25 mg/L) describes a laboratory solution or a patient's blood sample. Either way the relevant volume is 200 Litres.

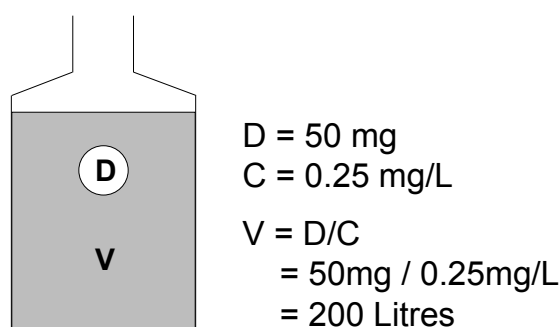

Figure 3.12 A simple example of the relationship between drug dose, concentration and volume for a bottle or a patient

It was stated earlier that the intended physical meaning of the volume of distribution was that it should reflect the extent of drug distribution out of the blood into the tissues. Figure 3.13 shows that V does indeed reflect that property.

- In (a) most of the drug stays in the blood, leaving a high blood concentration. When we calculate $V = D/C$ we obtain a small volume. We thus achieve the relationship we wanted – a low tendency for drug to move from the blood into the tissues is associated with a small value for V .
- In (b) more of the drug has moved from the blood – this leaves a lower concentration – the calculated value of V is greater.
- In (c) there is very extensive movement – little drug remains in the blood – calculated V is appropriately large, reflecting the degree of movement into the tissues.

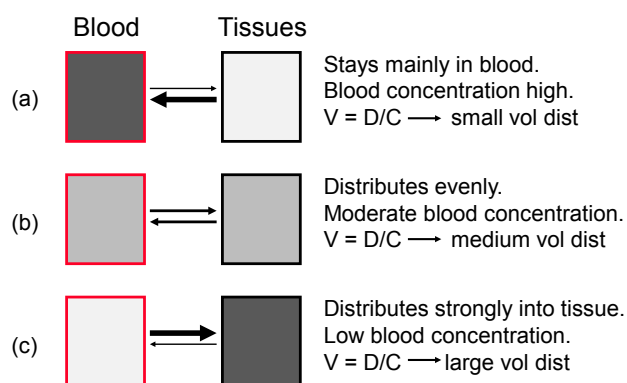

Figure 3.13 The volume of distribution reflects the extent of drug movement out of the blood into tissues

Table 3.2 shows the average volume of distribution in a 70kg adult for a range of drugs which have been selected to illustrate the wide range of values that can arise.

| Substance | Volume of distribution (L) | Broad class |
|--------------|----------------------------|--|
| Adalimumab | 5 | Small: Mainly retained in the blood. |
| Warfarin | 7 | |
| Gentamicin | 16 | |
| Theophylline | 35 | Medium: Distributed fairly evenly between blood and tissues. |
| Cimetidine | 140 | Large: Majority of drug moves out of blood into the tissues. |
| Digoxin | 510 | |
| Doxepin | 1,600 | |
| Chloroquine | 15,000 | |

Table 3.2 Volumes of distribution of substances with widely varying characteristics.

The three substances with small volumes are retained in the blood for differing reasons. Adalimumab is a monoclonal antibody (a protein with a molecular weight well over 100,000) that is virtually restricted to the plasma compartment. Warfarin binds tightly to serum albumin which prevents it from distributing and gentamicin is a very water soluble antibiotic with limited distribution and very little penetration into cells.

The three large volume substances all bind to intracellular components. Digoxin binds to a tissue protein, doxepin is a very lipid soluble molecule that dissolves into fat in the tissues and chloroquine binds strongly to DNA.

3.6 Using the volume of distribution to calculate dose size

For clinical purposes, the main use of the volume of distribution is to allow the calculation of a dose of drug that will result in an appropriate blood concentration of drug in a patient. As an example we will calculate a dose size for aminophylline:

The previously recognized relationship:

$$C = D / V$$

Can be re-arranged to:

$$D = C \times V$$

Thus, if we know the target concentration for a drug and its likely volume of distribution in a particular patient, we can calculate a suitable dose. The next three sections show the steps in the calculation:

3.6.1 Obtaining a value for the target concentration

For key drugs we know from previous experience that a certain range of blood concentrations is likely to produce an effect that is adequate, but not toxic. With theophylline, we commonly aim for concentrations within the range of 10 to 20 mg/L. We normally target the middle of the acceptable range, so in this case 15 mg/L.

Please click the advert

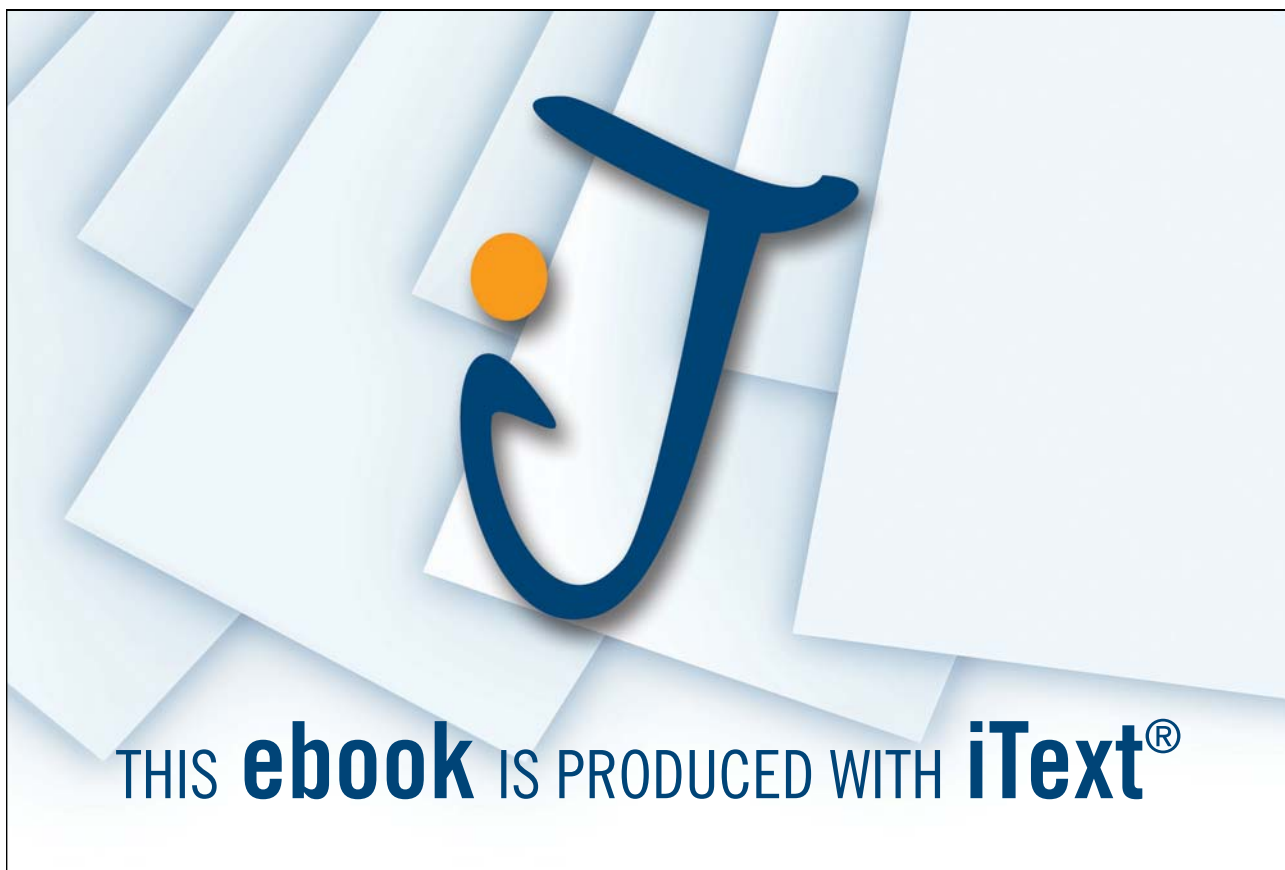

3.6.2 Obtaining a value for the volume of distribution from the population mean expressed on a 'per Kg body weight' basis.

How can we obtain a value for the volume of distribution for a drug in a particular patient, if that patient has not previously been treated with the relevant drug? Fortunately, volume of distribution is closely related to body mass. During the early stages of drug development, the volume of distribution of the drug will be determined in a series of patients. Values will probably vary considerably between patients of differing sizes, but will generally be much more consistent when expressed on a 'per Kg body weight' basis. Thus the actual volume for theophylline in a particular patient might be 35L, but if that patient weighed 70Kg, this would be reported as 0.5 L/Kg. The generally accepted mean volume for theophylline is 0.48 L/Kg.

3.6.3 The dose calculation

A new patient is to be treated with theophylline (actually administering its salt aminophylline; $S = 0.8$). He is of fairly normal build and weighs 80Kg. Target concentration for theophylline will be 15mg/L. We would calculate an appropriate intravenous dose of aminophylline in three stages.

- First calculate the patient's likely volume of distribution for theophylline as:

$$\begin{aligned} V &= 0.48 \text{ L/Kg} \times 80 \text{ Kg} \\ &= 38.4 \text{ L.} \end{aligned}$$

- Then calculate a theophylline dose as:

$$\begin{aligned} D &= C \times V \\ &= 15 \text{ mg/L} \times 38.4 \text{ L} \\ &= 576 \text{ mg} \end{aligned}$$

- Correct for the salt factor

$$\begin{aligned} \text{Dose} &= D / S \\ &= 576 \text{ mg} / 0.8 \\ &= 720 \text{ mg aminophylline} \end{aligned}$$



The principle clinical value of the volume of distribution lies in allowing the calculation of a drug dose that will achieve some specified blood concentration.

Predicted volumes, based on body weight, tend to be precise enough for practical purposes, so long as patients are of fairly average build. However, with very over-weight patients, their ratio of fat to muscle will be increased. A relatively water soluble drug like digoxin will show limited distribution into fat and a volume estimated from total body weight is likely to be biased upwards. With such drugs, it is better to estimate volume of distribution from a patient's ideal rather than actual weight.

3.7 Practice calculations

Notice that the main skill required for these calculations is the appropriate use of units. Make sure that at all stages, you use the correct units for all values and that calculations do not use mixed units (e.g. mg and μg or mL and L). It is useful to remember that ...

$$1000\text{ng} = 1\mu\text{g}$$

$$1000\mu\text{g} = 1\text{mg}$$

$$1\mu\text{g/L} = 1\text{ng/mL}$$

$$1\text{mg/L} = 1\mu\text{g/mL}$$

- 1) A drug has a desirable concentration range of 150-250 $\mu\text{g/L}$. Its mean volume of distribution is 0.72 L/Kg. What bolus i.v. dose should be administered to a patient weighing 65 Kg? (Answer in units of mg)
- 2) A drug has a mean volume of distribution of 0.91 L/Kg and a desirable concentration range of 20-40 $\mu\text{g/L}$. A 5mg bolus i.v. dose of this drug is to be administered to a patient weighing 80Kg. Is this dose likely to be satisfactory?
- 3) An initial concentration of 12.5 ng/mL arises following the bolus i.v. administration of 200 μg of a drug. Calculate the volume of distribution of this drug in this patient (in units of L).
- 4) A dose (5mg) of a salt that contains 70% by weight of the parent drug is administered by bolus i.v. injection. The volume of distribution of the drug is 70 L. Calculate the initial concentration of the drug (in units of ng/mL).
- 5) 0.5 mg of a drug is administered by bolus i.v. injection. The initial concentration is 20ng/mL. Calculate the volume of distribution of the drug (in units of L).
- 6) A drug has a mean volume of distribution of 0.45 L/Kg. It is to be administered (bolus i.v. dose) as a salt that contains 75% by weight of the parent drug. The patient weighs 70Kg. The desirable concentration range for the parent drug is 400-700 ng/mL. What dose of the drug should be administered? (Answer in units of mg.)

Answers are available in the final section of the book.

4 Elimination: Elimination rate constant, half-life and clearance

In this chapter we will consider the various parameters that are used to describe the rate at which drugs are eliminated from the body. All sections of this chapter are essential to both drug development and clinical practice.

4.1 Elimination rate constant and half-life

4.1.1 Elimination rate constant

As explained in Section 2.2, it is assumed that the rates of kinetic processes are first order with respect to the supply of drug waiting to undergo that process. Consequently, we model the rate of drug elimination as being directly proportional to the amount of drug in the patient that is available for elimination. The constant that links the rate of elimination to the available mass of drug is the 'Elimination rate constant'. In this book the symbol 'K' will be used to represent the elimination rate constant, but be aware that other authors may use symbols such 'k' or 'K_e'. The relationship can then be written as;

$$\text{Rate of elimination} = \text{Mass} \times K$$

It can be seen that if we halve or double the amount of drug available, we will halve or double the rate of elimination.

Please click the advert



www.job.oticon.dk

oticon
PEOPLE FIRST

If we take a simple example of a drug that occupies one compartment and there is (say) 10mg of the drug present in a patient's body and the drug is being eliminated at a rate of 1mg per hour, then the rate constant could be calculated by a simple re-arrangement of the former equation:

$$\begin{aligned} \text{Rate} &= \text{Mass} \times K \\ K &= \text{Rate} / \text{Mass} \\ &= 1\text{mg/h} / 10\text{mg} \\ &= 0.1 \text{ h}^{-1} \end{aligned}$$

The units 'h⁻¹' may not make any immediate sense, but can be read as 'per hour'. Since 0.1 is one tenth, the rate constant can be read as 'One tenth per hour'. That now makes perfectly good sense – the body removes drug at a rate equivalent to one tenth of the body load per hour. This is now a fixed figure for this particular drug in this particular patient. If at some other time, the patient's body contained 20mg of drug, the rate of elimination would be 2mg/h and if the load was 5mg, the rate would be 0.5mg/h. Figure 4.1 shows the relationship that would exist between rate of elimination and drug load, in the case where $K = 0.1\text{h}^{-1}$.

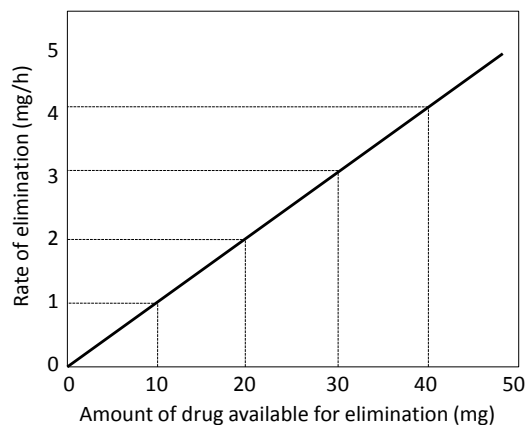

Figure 4.1 Relationship between rate of elimination and body load of drug when $K = 0.1\text{h}^{-1}$



K - the elimination rate constant - expresses rate of drug elimination as the proportion of body load being eliminated per unit time.

A term that is often used to describe this simple model is 'Linear kinetics' – a reference to the graph above.

In the examples given above, we talked in terms of the proportion of drug being removed per hour. Logically, one could report the proportion removed per second, minute or day. To convert to another unit, the value is simply multiplied or divided by the appropriate proportion. Thus the rate constant quoted above (0.1 h^{-1}) could be divided by 60 to yield an equivalent value of 0.00167 min^{-1} . Note that we divide rather than multiply by 60, as the proportion removed per minute will be less than that removed in an hour.

We generally select a time unit within which the proportion removed, takes a convenient value. For most drugs, the proportion eliminated per hour tends to be fairly sensible, hence the common use of units of h^{-1} . Taking the example above one stage further, we could express K as $0.0000278 \text{ sec}^{-1}$ which is mathematically correct, but the fraction is inconveniently small.

4.1.2 Half-life

Another way to express rate of drug elimination is via the half-life – the time required for blood concentration to fall by 50%. This is a highly intuitive measure; we recognize immediately that a drug with a half life of 10 minutes is going to behave in a manner radically different from one with a half-life of 48 hours.

Half-life and K have been dealt with together because, although they appear superficially to be very different, there is in fact a deep similarity; they both express the proportion of drug eliminated in a certain period of time. The difference is:

- K takes a fixed unit of time (One minute, hour, day etc) and reports the proportion eliminated within that time.
- Half-life takes a fixed proportion (50%) and reports the amount of time required for that proportion to be eliminated.

Given that they are performing fundamentally the same function, it should be no great surprise that the two measures are easily inter-converted using the formulae:

$$t_{1/2} = 0.693 / K$$

$$K = 0.693 / t_{1/2}$$

The figure of 0.693 arises because it is the natural log of 2; it is a fixed constant and is not in any way dependent upon the particular drug or patient. An appendix at the end of the next chapter gives the derivation of these equations.

So, taking our earlier example of a drug with an elimination rate constant of 0.1 h^{-1} , its half life will be:

$$t_{1/2} = 0.693 / 0.1\text{h}^{-1}$$

$$= 6.93 \text{ h}$$

You may see a figure of 0.7 used instead of the exact constant of 0.693. The figure of 0.7 is certainly more memorable and introduces an error of just 1%, which is trivial in the context of any practical clinical dosing calculation.

4.1.3 Variation in half-life between drugs

Drugs vary widely in their rates of elimination and Table 4.1 includes examples from across the spectrum. In Chapter 10 we will refer to practical problems that can arise if drug half-lives are either excessively short or long.

| Drug | Half life (Hours) |
|----------------|-------------------|
| Amoxicillin | 1 |
| Cefamandole | 1 |
| Cimetidine | 2 |
| Propranolol | 4 |
| Theophylline | 9 |
| Griseofulvin | 15 |
| Lithium | 22 |
| Warfarin | 37 |
| Digoxin | 42 |
| Phenobarbitone | 86 |

Table 4.1 Examples of drug half-lives

4.1.4 Variation in half-life between patients

The values quoted in Table 4.1 are averages across patients. Any given drug will show variation in half-life between patients. For a drug such as gentamicin which is renally excreted, this will depend upon kidney function and for a drug like theophylline, which undergoes metabolism, liver function will be crucial. As an example, gentamicin has a half-life of about two hours in a healthy adult but this can be extended to 12 hours or more in renal disease.

Please click the advert

01001001 01010100
 00100000 01010100
 01110010 01100001
 01101001 01101110
 01100101 01100101

Sie sehen hier mehr als Nullen und Einsen?

Wir sehen Ihre Karriere im IT-Trainee-programm. Als spätere Fach- oder Führungskraft.

www.perspektiven.allianz.de

Allianz Karriere

Allianz 

4.2 Clearance

4.2.1 Definition of clearance

'Clearance' (Cl) is another pharmacokinetic parameter used to describe drug elimination. To explain clearance, it is helpful to refer to another concept – 'Extraction ratio'.

Figure 4.2 shows blood flowing through the liver from left to right. The blood contains a drug that can be eliminated ('Extracted') by the liver. The concentration of drug in blood entering the liver (C_{in}) is 10 mg/L but by the time blood exits the liver, this has been reduced to 4 mg/L (C_{out}). The extraction ratio (E) is the proportion of drug eliminated as blood passes through the liver. The amount removed is the difference between C_{in} and C_{out} ($10 - 4 = 6\text{mg/L}$) and this is then expressed as a proportion of drug entering the liver, which is 0.6 or 60%.

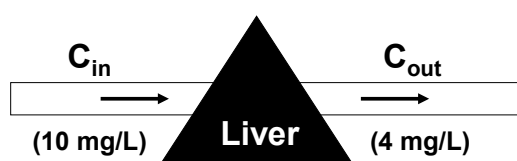

$$E = \frac{C_{in} - C_{out}}{C_{in}}$$

$$E = \frac{10 - 4}{10} = \frac{6}{10} = 0.6 \text{ or } 60\%$$

Figure 4.2 Calculation of extraction ratio

Figure 4.3 includes the blood flow through the liver. This labelled as ' Q_H '; Q is used to indicate blood flow and H specifies hepatic blood flow. Flow is shown as 2 litres per minute. In this figure, it is assumed that all drug entering the liver is extracted ($E = 1.0$). In this very simple example, clearance of the drug is said to be 2 L/min, as all the drug is stripped out of 2 litres of blood every minute.

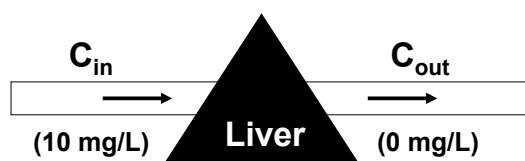

$$Q_H = 2 \text{ L/min}$$

$$E = 1.0$$

$$Cl = 2 \text{ L/min}$$

Figure 4.3 Clearance with complete extraction.

The situation described in Figure 4.3 would be very unusual, with all the drug being extracted during passage through the liver. A more normal situation is shown in Figure 4.4, where the extraction ratio is only 0.5 (50%). Blood flow is still 2 L/min. The rate of drug extraction is now equivalent to a situation where all the drug is extracted from one litre of blood per minute i.e. 50% of the actual blood flow of 2 litres. In terms of the rate of drug elimination, there is no difference between taking all the drug out of 1 litre or 50% of the drug out of 2 litres of blood. The effective clearance for the situation shown in Figure 4.3 is therefore 1 L/min.

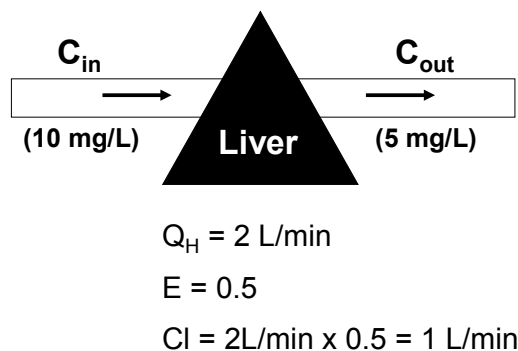

Figure 4.4 Clearance with partial extraction.



Clearance is the volume of blood effectively cleared of drug per unit time.

The general definition of hepatic clearance is therefore:

$$Cl = Q_H \times E$$

If a drug is eliminated by renal excretion, clearance is similarly defined, but we need to refer to renal blood flow (Q_R) and the extraction ratio for the drug as it flows through the kidney. Some drugs, such as digoxin, are significantly eliminated by both hepatic and renal extraction and in such cases, total body clearance is simply the sum of the hepatic and renal clearances calculated as above.

4.2.2 Units of clearance

Clearance is always expressed in the same units that would be used for a flow of liquid. Above, L/min was used, but units such as L/h or mL/min are frequently met with.

4.2.3 Why another parameter?

The reader may wonder why we need another indicator of rate of drug elimination when we already have K ? In the next few chapters, it will emerge that when we want to calculate drug concentrations at particular points in time, we most conveniently use equations that include K , but to predict long term average concentrations, the most convenient equations use Cl .

4.2.4 Another definition of the elimination rate constant

The definition of K presented in Section 4.1 is said to be expressed in ‘Mass terms’. K was defined as the ratio between the **mass** of drug eliminated per unit time and the **mass** of drug present in the body.

Figure 4.5, considers clearance in the context of the complete body along with its volume of distribution. The drug is distributed throughout a space of 50 litres and clearance is indicated as 5 L/h. Thus, five out of fifty litres (one tenth) of the volume is cleared per hour, implying that one tenth of the drug present in the body will be removed per hour. So, K must be 0.1 h^{-1} . Clearance can therefore be expressed alternatively in ‘Volume terms’ as the ratio between the **volume** from which drug is cleared and the total **volume** throughout which the drug is distributed.



K can be defined either as the proportion of the mass of drug that is eliminated per unit time or as the proportion of the volume the drug occupies that is cleared per unit time.

Please click the advert

Turning a challenge into a learning curve.
Just another day at the office for a high performer.

Accenture Boot Camp – your toughest test yet

Choose Accenture for a career where the variety of opportunities and challenges allows you to make a difference every day. A place where you can develop your potential and grow professionally, working alongside talented colleagues. The only place where you can learn from our unrivalled experience, while helping our global clients achieve high performance. If this is your idea of a typical working day, then Accenture is the place to be.

It all starts at Boot Camp. It's 48 hours that will stimulate your mind and enhance your career prospects. You'll spend time with other students, top Accenture Consultants and special guests. An inspirational two days

packed with intellectual challenges and activities designed to let you discover what it really means to be a high performer in business. We can't tell you everything about Boot Camp, but expect a fast-paced, exhilarating

and intense learning experience. It could be your toughest test yet, which is exactly what will make it your biggest opportunity.

Find out more and apply online.

Visit accenture.com/bootcamp

• Consulting • Technology • Outsourcing



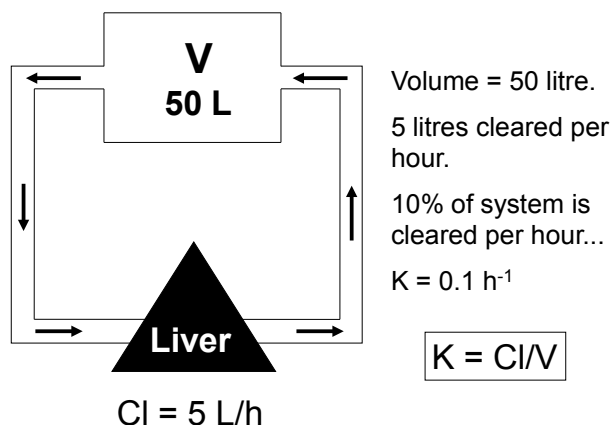

Figure 4.5 Clearance considered along with a drug's volume of distribution

We can either say 'One tenth of the drug mass is eliminated per hour' or 'One tenth of the volume that the drug occupies is cleared per hour'; either way, the elimination rate constant K is 0.1 h^{-1} .

The relationship was expressed above as:

$$K = Cl / V$$

However, for clinical calculations it is more likely to be used in its re-arranged form:

$$Cl = K \times V$$

4.2.5 Expressing clearance relative to body weight

Section 3.6.2 showed how volume of distribution could be expressed relative to body weight and clearance can be treated in a similar manner. If the clearance of a drug in a patient was 10 L/h and he/she weighed 50 Kg , then clearance could be expressed as $10 \text{ L/h} / 50 \text{ Kg} = 0.2 \text{ L/h/Kg}$.

This approach can then be used to predict likely clearance in a particular patient. It is known that in healthy young adults, the average clearance of theophylline is approximately 0.04 L/h/Kg . So, if a patient weighs 75 Kg , we would predict that their clearance to be $0.04 \text{ L/h/Kg} \times 75 \text{ Kg} = 3 \text{ L/h}$.

Unfortunately, clearance is subject to much greater modification by disease, smoking and the use of other drugs than is volume of distribution. Consequently, predicted clearance values tend to be less precise than predicted volumes of distribution. These effects can be so great, that predicted clearances may need to be adjusted to take account of some of the more powerful influences such as smoking.

4.3 Practice calculations

Notice that once again, a major factor in these calculations is the appropriate use of units.

- 1) A drug has an elimination rate constant of 0.0131 h^{-1} . Calculate its elimination half-life.
- 2) Hepatic blood flow is 1.2 L/min and a drug has an hepatic extraction ratio of 0.04 . Calculate the drug's clearance in units of L/h .
- 3) A drug has an elimination half life of 12 hours. Calculate its elimination rate constant.
- 4) A drug has a volume of distribution of 25 litres and an elimination rate constant of 0.03 h^{-1} . Calculate its clearance in units of mL/h .
- 5) A drug has a volume of distribution of 175 litres and its clearance is 0.43 L/min . Calculate its half-life in units of h .
- 6) A drug has a clearance of 12.5 mL/min and a volume of distribution of 12 litres. Calculate its elimination rate constant in units of h^{-1} .
- 7) A drug has a population average clearance of 1.5 mL/min/Kg body weight. A patient weighs 85 Kg . Predict the patient's clearance for the drug in units of L/h .

Answers are available in the final section of the book.

5 Single intravenous bolus injection into one compartment

The contents of this chapter are relevant to both drug development and clinical practice.

A bolus injection is one that is administered quickly and can be considered as being given at a single point in time. It is contrasted with an infusion, where drug is administered over several hours or even days. Figure 5.1 summarizes the situation to be considered.

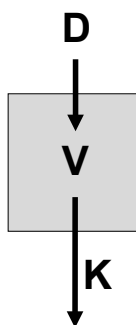

Figure 5.1 Schematic representation of a single i.v. bolus injection into one compartment

Please click the advert

Join the Vestas Graduate Programme

Experience the Forces of Wind
and kick-start your career

As one of the world leaders in wind power solutions with wind turbine installations in over 65 countries and more than 20,000 employees globally, Vestas looks to accelerate innovation through the development of our employees' skills and talents. Our goal is to reduce CO₂ emissions dramatically and ensure a sustainable world for future generations.

Read more about the Vestas Graduate Programme on vestas.com/jobs.

Application period will open March 1 2012.

Wind. It means the world to us.™

There is no absorption stage to consider as the drug is delivered directly into the blood stream, nor is there any distribution phase, as the drug occupies only one compartment. In fact, the only process to be considered is elimination. Hence, this is the simplest possible pharmacokinetic situation. The drug just spreads throughout its volume of distribution (V) and awaits its elimination as governed by the elimination rate constant (K).

5.1 Concentration versus time graph

Consider a case where 100mg of drug has been injected, the volume of distribution is 10 L and the elimination rate constant is 0.1 h^{-1} . Figure 5.2 is the concentration versus time graph for this scenario. This type of graph is at the heart of pharmacokinetics. They show the profile of drug concentration over time for a particular dosing regimen.

The concentration immediately after injection is referred to as the 'Initial concentration' and has the symbol C_0 (The zero referring to zero time after injection). In this case:

$$\begin{aligned} C_0 &= D / V \\ &= 100\text{mg} / 10\text{L} \\ &= 10\text{mg/L} \end{aligned}$$

This is shown as point A on the graph.

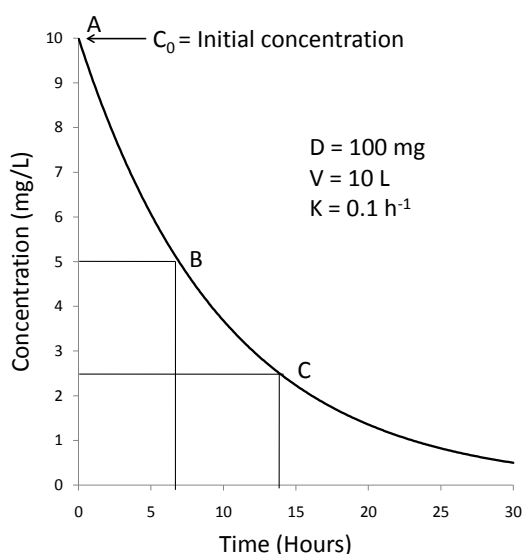

Figure 5.2 Concentration versus time graph for single i.v. bolus dose into one compartment

Elimination begins as soon as the drug is injected. We saw in the previous chapter that the rate of elimination depends upon the body load of drug and the elimination rate constant:

$$\begin{aligned} \text{Rate of elimination} &= \text{Mass} \times K \\ &= 100\text{mg} \times 0.1\text{h}^{-1} \\ &= 10 \text{ mg/h} \end{aligned}$$

This calculation that the rate of elimination will be 10 mg per hour is only true at the single point in time when the drug has just been injected. At any later time, the mass of drug present will have declined and the rate of elimination will also have fallen.

The half life of the drug can be calculated as:

$$\begin{aligned}\text{Half-life} &= 0.693 / K \\ &= 0.693 / 0.1 \text{ h}^{-1} \\ &= 6.93 \text{ hours}\end{aligned}$$

Point B on Figure 5.2 represents the point where half of the drug has been eliminated. The rate of elimination at this point is:

$$\begin{aligned}\text{Rate} &= \text{Mass} \times K \\ &= 50\text{mg} \times 0.1\text{h}^{-1} \\ &= 5 \text{ mg per hour (Half the initial rate)}\end{aligned}$$

After another half-life (Point C on the graph), the body load has halved again to 25mg and the rate of elimination is now only 2.5 mg per hour and so on.

The constantly declining rate of elimination gives the graph its distinctive, curving shape with initially rapid elimination and a quickly falling graph, but the graph becomes flatter and flatter with time. Technically, the graph follows an 'Exponential' curve.



The gradient of the concentration versus time graph reduces as body load of drug falls. The graph forms an exponential curve.

5.2 Relationship between time and concentration

5.2.1 Predicting concentration at a given time after injection

Shown below is the equation that allows us to calculate the remaining drug concentration at a specified time (t) after initial injection. The concentration remaining at this time is represented as C_t . Any exponentially declining value can be described by a standard equation ...

$$C_t = C_0 \times e^{-Kt}$$

The term ' e^{-Kt} ' is read as 'Exponential minus K T' and is often written as ' $\exp(-Kt)$ '. It appears in a number of places in kinetic calculations. Take it in two stages:

- e is a special number called 'Euler's e' which has a value of 2.718.
- e^{-Kt} is simply that number raised to the power $(-K \times t)$ where K is the elimination rate constant and t is the amount of time that has elapsed since drug injection.

Fortunately scientific calculators allow us to automate the calculation of exponentials; you simply need to know which buttons to push. Figure 5.3 shows a typical scientific calculator. Calculators make extra functions available by pressing either a 2nd function key or on some models, a Shift key. The function we want (e^x) is usually available from the ‘Natural log’ key labelled as ‘ln’. So, the key strokes would be:

- Press 2ndF (or Shift)
- Press ln
- Enter number (The value of $-K \times t$)
- Press =

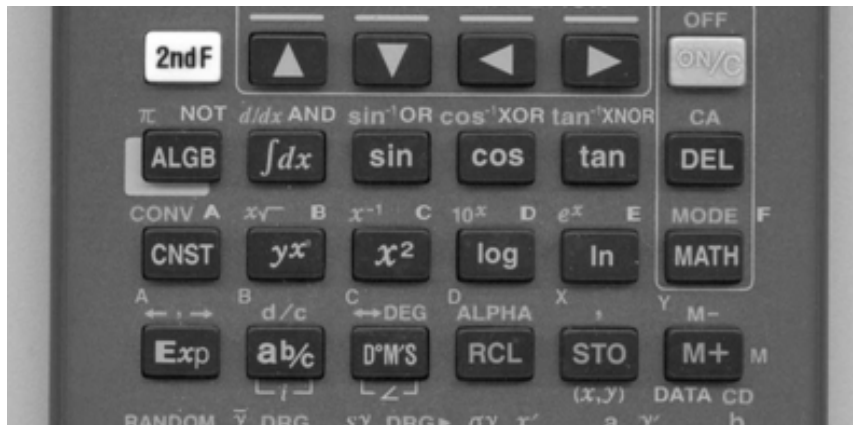

Figure 5.3 Keys used to calculate an exponential value using a typical scientific calculator

Please click the advert



it's an interesting world

Get under the skin of it.

Graduate opportunities
Cheltenham | £24,945 + benefits

One of the UK's intelligence services, GCHQ's role is two-fold: to gather and analyse intelligence which helps shape Britain's response to global events, and, to provide technical advice for the protection of Government communication and information systems. In doing so, our specialists – in IT, internet, engineering, languages, information assurance, mathematics and intelligence – get well beneath the surface of global affairs. If you thought the world was an interesting place, you really ought to explore our world of work.

www.careersinbritishintelligence.co.uk

Applicants must be British citizens. GCHQ values diversity and welcomes applicants from all sections of the community. We want our workforce to reflect the diversity of our work.



INVESTORS
 IN PEOPLE



Let us revert to the example described previously where the initial concentration was 10mg/L and $K = 0.1h^{-1}$ and calculate the concentration 12 hours after injection (See Figure 5.3).

$$\begin{aligned}
 C_t &= C_0 \times e^{-Kt} \\
 C_t &= C_0 \times \exp(-Kt) \\
 &= 10\text{mg/L} \times \exp(-0.1h^{-1} \times 12h) \\
 &= 10\text{mg/L} \times \exp(-1.2) \text{ [The exponential is now unitless as } h^{-1} \text{ and } h \text{ cancel out]}
 \end{aligned}$$

If we now use a calculator to obtain a value for $\exp(-1.2)$ as described above, it will be 0.301. The calculation becomes:

$$\begin{aligned}
 C_t &= 10\text{mg/L} \times 0.301 \\
 &= 3.01\text{mg/L}
 \end{aligned}$$

So, given an initial concentration of 10mg/L and an elimination rate constant of $0.1h^{-1}$, the concentration remaining after 12h should be 3.01mg/L. This agrees with Figure 5.3.

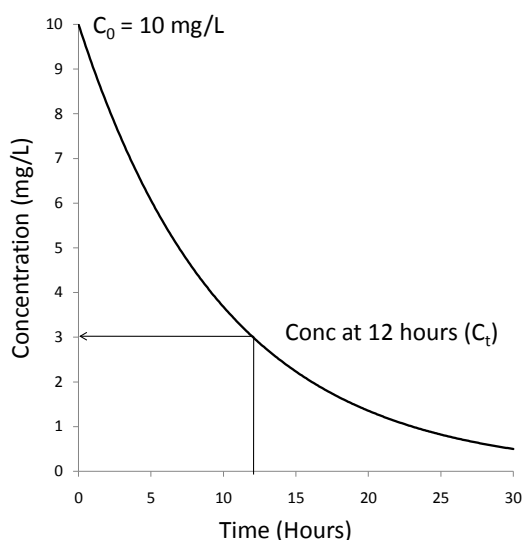

Figure 5.3 Calculating concentration at 12 hours post dosing.

5.2.2 Time at which concentration falls to a particular level

We may want to calculate how long it will take for drug concentrations to fall to some specified figure. For example, in drug overdose, we might want to know how long it would take for concentrations to fall to a safe level.

Consider the following scenario: Current drug concentration (C_0) is 35mg/L and concentrations below 20mg/L are likely to be safe. The drug has an elimination rate constant of $0.045h^{-1}$. In the absence of any special measures, how long would we have to wait for levels to fall low enough to be non-toxic?

We re-arrange the standard equation:

$$C_t = C_0 \times e^{-kt}$$

$$C_t / C_0 = e^{-kt}$$

$$20\text{mg/L} / 35\text{mg/L} = e^{-0.045\text{h}^{-1} \times t}$$

$$0.57 = e^{-0.045\text{h}^{-1} \times t} \text{ (Take natural logs of both sides)}$$

$$\text{Ln}(0.57) = -0.045\text{h}^{-1} \times t \text{ (Use the Ln button on your calculator to obtain natural log of 0.57)}$$

$$-0.56 = -0.045\text{h}^{-1} \times t$$

$$-0.56 / -0.045\text{h}^{-1} = t$$

$$t = 12.4\text{h}$$

A clinical judgement can now be made as to whether we can wait 12 hours for drug levels to fall spontaneously or whether artificial means such as hemodialysis are required to speed up the process.

5.3 Area Under the Curve (AUC)

Having become familiar with concentration versus time graphs, we can introduce a further pharmacokinetic parameter – the Area Under the Curve or AUC. The AUC is quite literally the area under a concentration versus time graph. See shaded area in Figure 5.4.

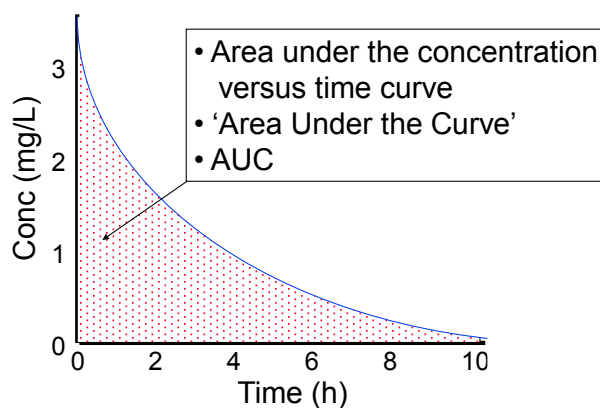

Figure 5.4 The Area Under the Curve (AUC)

The process of obtaining any area consists essentially of multiplying the height of a figure by its width. The height of this figure is measured in concentration units (mass/volume); mg/L in this particular case. The width is in time units; hours in this case. Hence this AUC would have units of $\text{mg}\cdot\text{L}^{-1}\cdot\text{h}$. However, the tidy-minded like to re-arrange the units to $\text{mg}\cdot\text{h}\cdot\text{L}^{-1}$ as it looks prettier. In general, the units of AUC should always be $\text{Mass}\cdot\text{Time}\cdot\text{Vol}^{-1}$.

Sometimes we want to refer to the area between specific time limits. Figure 5.5 shows a case where we refer to the area between 2 and 4 hours. We simply add a subscript to the AUC to indicate the relevant time interval. Any reference to 'AUC' without time limits can be taken to refer to the full AUC (i.e. between zero and infinity time). Thus AUC is generally equivalent to $\text{AUC}_{0-\infty}$.

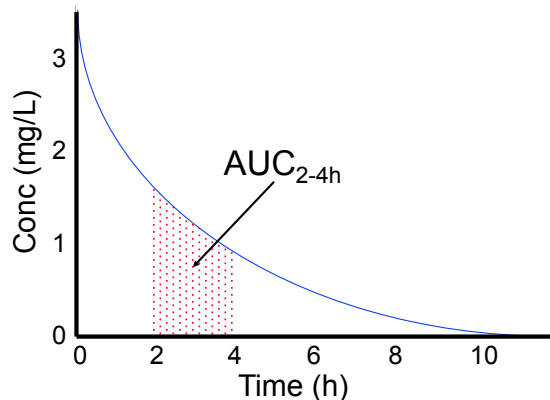

Figure 5.5 An AUC between specified time limits

AUC will clearly be related to dose, but the efficiency of elimination also has to be accounted for using clearance as the appropriate marker.

$$AUC = F.D / Cl$$

The derivation of this relationship is given in Appendix 2 to this chapter. We will use this relationship in Chapter 9 when determining bioavailability.

Please click the advert

Brain power



Plug into The Power of Knowledge Engineering.
Visit us at www.skf.com/knowledge

By 2020, wind could provide one-tenth of our planet's electricity needs. Already today, SKF's innovative know-how is crucial to running a large proportion of the world's wind turbines.

Up to 25 % of the generating costs relate to maintenance. These can be reduced dramatically thanks to our systems for on-line condition monitoring and automatic lubrication. We help make it more economical to create cleaner, cheaper energy out of thin air.

By sharing our experience, expertise, and creativity, industries can boost performance beyond expectations. Therefore we need the best employees who can meet this challenge!

The Power of Knowledge Engineering



5.4 Practice calculations

- 1) The initial concentration of a drug was 154 ng/mL and its elimination rate constant is 0.075h^{-1} . Calculate its concentration 12 hours later.
- 2) A drug has a population mean volume of distribution of 0.92L/Kg . A dose of 95 mg of the drug is administered as a single bolus dose to a patient weighing 60Kg. The elimination rate constant of the drug is 0.155h^{-1} . What will be its concentration 1 day after injection (in units of microgram/L)?
- 3) The current concentration of a drug is 5.2mg/L and its elimination rate constant is 0.078h^{-1} . How long will we have to wait for the concentration to fall to 1mg/L ?
- 4) The initial concentration of a drug was 10mg/L and 24 hours later this had fallen to 2mg/L . Calculate the elimination rate constant of this drug.
- 5) A drug has a volume of distribution of 125 litres and elimination rate constant of 0.15h^{-1} . A patient receives a single i.v. bolus dose of 25mg of the drug. Calculate the AUC following this dose.

Answers are available in the final section of the book.

5.5 Appendix 1

Derivation of the equations $t_{1/2} = 0.693 / K$ and $K = 0.693 / t_{1/2}$ (Introduced in Chapter 4)

Take the general equation for declining drug concentrations in a one compartment model ...

$$C_t = C_0 \times e^{-Kt}$$

Now use this to describe the situation when time (t) is equal to the half-life of the drug: At that point: $t = t_{1/2}$ and $C_t = 0.5 \times C_0$

So:

$$(0.5 \times C_0) = C_0 \times e^{-K \cdot t_{1/2}}$$

$$(0.5 \times C_0) / C_0 = e^{-K \cdot t_{1/2}}$$

$$0.5 = e^{-K \cdot t_{1/2}}$$

(Take natural logs of both sides ...)

$$\text{Ln}(0.5) = -K \times t_{1/2}$$

$$-0.693 = -K \times t_{1/2}$$

$$t_{1/2} = -0.693 / -K$$

$$t_{1/2} = 0.693 / K$$

(Re-arrange ...)

$$K = 0.693 / t_{1/2}$$

5.6 Appendix 2

Derivation of the equation: $AUC = F.D / Cl$

The following symbols will be used:

'ElimRate' = Rate of drug elimination at any given time

' M_t ' = Mass of drug present at time t

' C_t ' = Concentration of drug at time t

'Tot elim' = Total amount of drug eliminated between time zero and infinity

$$M_t = C_t \times V$$

$$\text{ElimRate} = M_t \times K$$

Combine two equations above ...

$$\begin{aligned} \text{Elim rate} &= C_t \times V \times K \text{ (as } V \times K = Cl \text{ ...)} \\ &= C_t \times Cl \end{aligned}$$

The total amount of drug eliminated over time = the integral of the rate of elimination, so ...

$$\begin{aligned} \text{Tot elim} &= \int_0^{\infty} \text{ElimRate} \\ &= \int_0^{\infty} C_t \times Cl \end{aligned}$$

The integral of the concentration versus time graph ($\int_0^{\infty} C_t$) is the AUC, so ...

$$\text{Total elim} = AUC \times Cl$$

Total drug ultimately eliminated = amount of drug that initially entered the body i.e. $F \times D$

$$F \times D = AUC \times Cl$$

$$AUC = F.D / Cl$$

6 Analysis of experimental data from a bolus i.v. injection into one compartment

In this chapter we will see how we use information about drug concentrations at various times following a test dose to calculate volume of distribution, elimination rate constant and clearance for a drug in a particular patient.

In Section 6.1, we focus on data in the format that typically arises in clinical trials – blood concentrations measured at numerous time points. This will be of some interest to all readers, but is especially relevant to those interested in drug development.

In Section 6.2, we look at data that is realistically likely to be available in clinical practice. In this setting, blood samples are unlikely to have been taken at numerous time points. At best, we will probably have blood levels at two time points following a previous dose. This section will be primarily of interest for the clinical application of pharmacokinetics.

Please click the advert

See the light!
The sooner you realize we are right,
the sooner your life will get better!

A bit over the top? Yes we know!

We are just that sure that we can make your media activities more effective.



Get "Bookboon's Free Media Advice"
 Email kbm@bookboon.com



CREDIT SUISSE

DAIMLER



Microsoft

bookboon.com

6.1 Analysis of clinical trials data

In a typical pharmacokinetic experiment, blood samples are taken at various times post dosing and analysed for drug content. Table 6.1 shows some results when 125mg of a drug have been administered as a single i.v. bolus and blood samples taken at various times between 2 and 24 hours post dosing. We want to determine the volume of distribution, elimination rate constant and clearance for the drug in this patient. Here we will consider a manual graphical approach; Chapter 13 describes an automated computerized method.

| Time (h) | Concentration (mg/L) |
|----------|----------------------|
| 2 | 4.10 |
| 4 | 2.65 |
| 8 | 2.00 |
| 14 | 1.05 |
| 24 | 0.19 |

Table 6.1 Observed drug concentrations at various times following a single i.v. bolus injection of 125mg drug

6.1.1 Manual graphical analysis

Figure 6.1 shows the data points plotted as a simple graph and includes a curve fitted by eye.

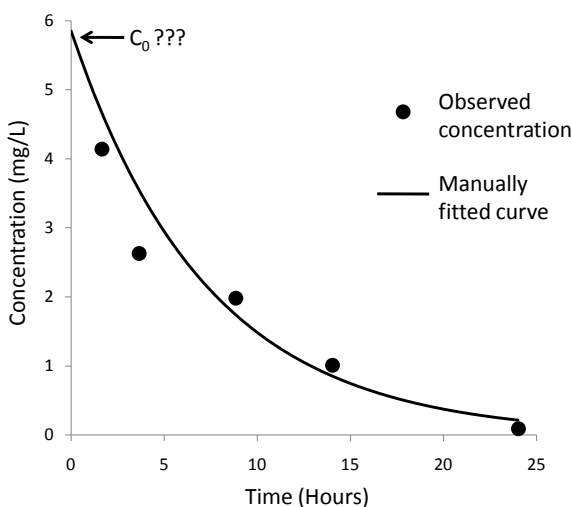

Figure 6.1 The problem of trying to obtain a theoretical value for C_0 using a simple graph of concentration versus time.

To obtain the volume of distribution will have to use the relationship $V = D / C$. However, the concentration is continually changing. The concentration we need to consider is that immediately after dosing (Concentration at time zero = C_0). It is only at this time point that the entire dose is actually present in the patient. Hence the practical, working formula is:

$$V = D / C_0$$

In real pharmacokinetic experiments, it is generally unrealistic to try to obtain a blood sample at time zero, as this would mean injecting the drug into one vein and taking a sample out of another simultaneously. The normal solution is to fit a line or curve to the data and back-extrapolate to time zero to determine what the initial concentration must have been, although no sample was actually taken at that time. This is referred to as the 'Theoretical C_0 '.

It is obvious from Figure 6.1 that there would be a great deal of subjectivity in fitting a curve to the points and, in particular, the attempted extrapolation of the curve is highly error prone. Several analysts attempting to fit and extrapolate a curve would probably produce a wide range of estimates for theoretical C_0 .

6.1.2 Linearizing the data using semi-log graph paper

It would be much more satisfactory if we could modify the plotting procedure so that the points formed a straight line (linearization). The first appendix to this chapter demonstrates that plotting the data onto semi-log graph paper will achieve linearization. This paper has a logarithmic vertical scale which means that we are effectively plotting the log of the concentration versus time instead of the simple concentration versus time.

Excellent quality, semi-log graph paper can be downloaded (free) from www.customgraph.com. From Linear / Semi-Log / Log-Log etc, select Semi-Log. Set Orientation: to Portrait and set Log Cycles: to the appropriate number (2 for the present case).

The plotted graph is shown in Figure 6.2. There are a number of things to note concerning semi-log graphs.

- The vertical scale is 'Logarithmic' – it has uneven spacing which means that when the drug concentrations are plotted onto this scale, the graph is linearized.
- The horizontal scale is a simple linear scale. Because only one axis is logarithmic, the paper is referred to as 'Semi-log'.
- The vertical scale covers two orders of magnitude, allowing us to plot a maximum of a 100-fold range of drug concentrations. In this case the vertical scale has been numbered from 0.1 to 1.0 (1st cycle) and then from 1 to 10 (2nd cycle). If the observed drug concentrations had been higher or lower, then the axis could have been numbered from (say) 1 to 100 or from 0.01 to 1.0. In all these cases, there is a 100-fold range of values. If the observed drug concentrations had covered a wider range, then semi-log paper with more cycles would be required. Three-cycle paper will allow for a 1,000-fold range of concentrations and four-cycle, 10,000 and so on. For our purposes, two-cycle paper is adequate.
- The numbering of the vertical axis must begin at some exact power of 10. Thus it is acceptable to start at 0.001, 0.01, 0.1, 1, 10, 100, 1,000 etc. However, it cannot begin at (say) 2 or 3.5 and in particular, it cannot begin at zero. For our purposes, the lowest concentration to be accommodated is 0.19mg/L and so the numbering has started at 0.1.
- We need to be able to back-extrapolate the graph to obtain the theoretical initial concentration (C_0) and so numbering of the horizontal axis must begin at time zero, even though the first sample was not taken until two hours.

Notice that we only obtain a straight line from a semi-log plot if the drug occupies one compartment. When data for a drug that occupies two compartments is plotted on semi-log paper the graph has a clear bend in it.



It is common to see pharmacokinetic data plotted as the log of the concentration versus time or (more likely) presented on a semi-log graph.

We now need to read off two values from Figure 6.2:

- The theoretical C_0
- The drug half-life

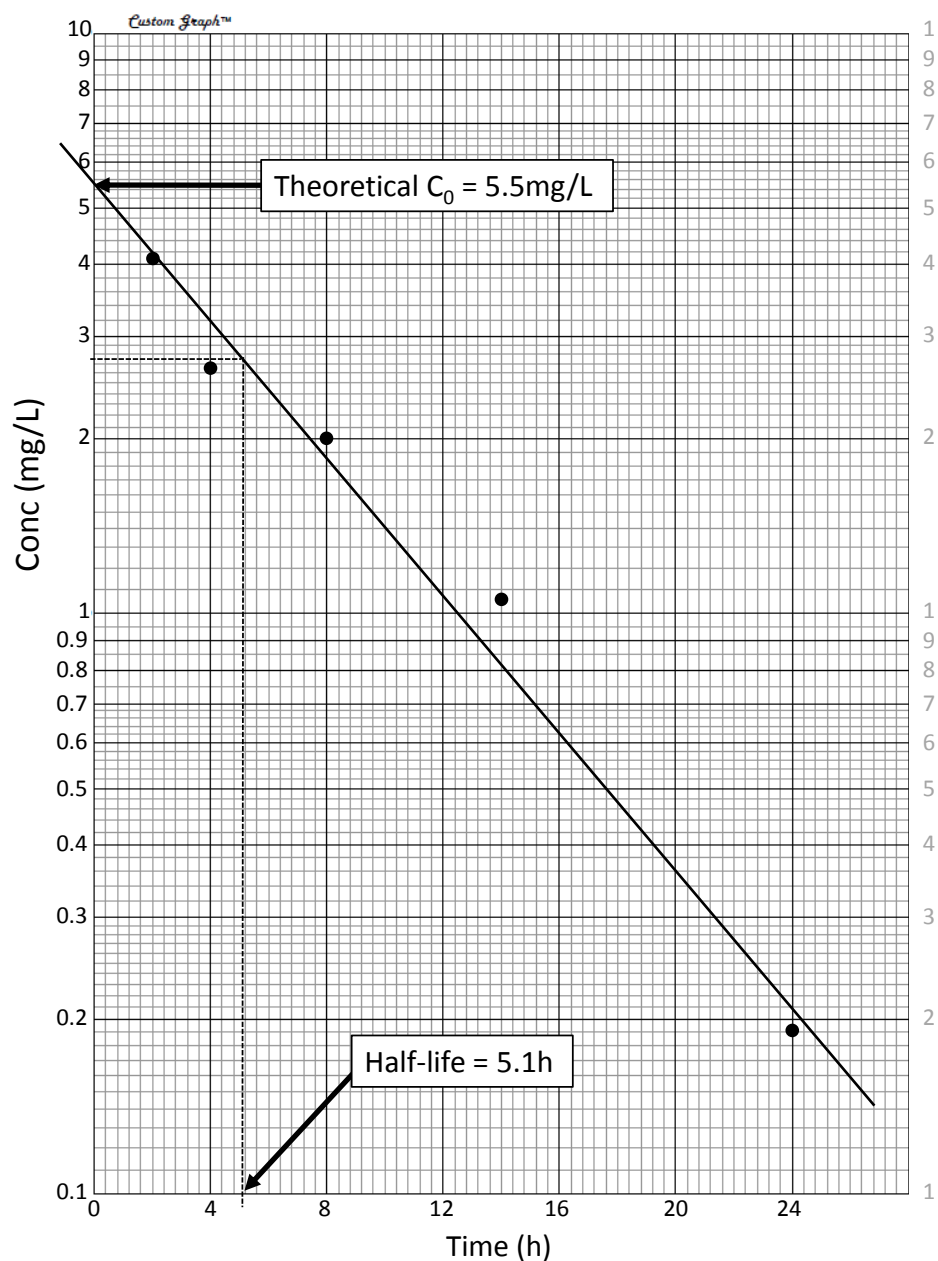

Figure 6.2 Concentration versus time on semi-log graph paper

We do not have a direct observation of initial drug concentration, but by back-extrapolation, we can determine that the 'Theoretical C_0 ' is 5.5mg/L (See Figure 6.2). The half-life is then the amount of time required for concentrations to fall to half of C_0 i.e. $5.5/2 = 2.75$ mg/L. From the graph, this occurred at 5.1h.

We can now calculate:

$$\begin{aligned} V &= D / C_0 \\ &= 125\text{mg} / 5.5\text{mg/L} \\ &= 22.7 \text{ L} \end{aligned}$$

$$\begin{aligned} K &= 0.693 / \text{Half-life} \\ &= 0.693 / 5.1\text{h} \\ &= 0.136 \text{ h}^{-1} \end{aligned}$$

$$\begin{aligned} \text{Cl} &= K \times V \\ &= 0.136 \text{ h}^{-1} \times 22.7 \text{ L} \\ &= 3.09 \text{ L/h} \end{aligned}$$

Trust and responsibility

NNE and Pharmaplan have joined forces to create NNE Pharmaplan, the world's leading engineering and consultancy company focused entirely on the pharma and biotech industries.

Inés Aréizaga Esteva (Spain), 25 years old
Education: Chemical Engineer

– You have to be proactive and open-minded as a newcomer and make it clear to your colleagues what you are able to cope. The pharmaceutical field is new to me. But busy as they are, most of my colleagues find the time to teach me, and they also trust me. Even though it was a bit hard at first, I can feel over time that I am beginning to be taken seriously and that my contribution is appreciated.

Please click the advert



NNE Pharmaplan is the world's leading engineering and consultancy company focused entirely on the pharma and biotech industries. We employ more than 1500 people worldwide and offer global reach and local knowledge along with our all-encompassing list of services.
nnepharmaplan.com

nne pharmaplan®

6.1.3 Computerized analysis of experimental data

There are a number of established commercial programs such as WinNonlin that are used to analyze pharmacokinetic data. These have the advantage that the analysis is objective, whereas the fitting of a line described above (Section 6.1.2) is subjective and different analysts might fit somewhat different lines. The manner of operation of these programs is fairly technical and a knowledge of this is probably unnecessary for some readers. An account is provided, but has placed as one of the later chapters (Chapter 13).

6.2 Analysis of data arising in a clinical setting

In this section it will be assumed that we have just two blood levels of the drug. If a drug occupied two compartments and we only had two observations it would be impossible to analyse the data, so this section assumes that our drug occupies just one compartment. It will also be assumed that (as stated in the previous section) it is impractical to obtain a blood sample at time zero following administration. Instead, we will have two samples – one early and one later.

A scenario where we might be faced with such data would be gentamicin treatment. While this drug's behaviour does not quite adhere to a single compartment, it approximates it nearly enough for practical purposes. It is clinically realistic that a patient would receive a bolus i.v. dose of gentamicin, after which two blood samples could be obtained and that, based on these, we would wish to calculate V and K for the individual patient. The times at which the two samples were obtained will be designated as T_1 and T_2 and the drug concentrations at these times will be C_1 and C_2 .

From these, K can be calculated using the equation below (See Appendix 2 to this chapter for derivation of equation):

$$K = \text{Ln}(C_1/C_2) / (T_2 - T_1)$$

In order to calculate volume of distribution, we will need a value for C_0 . We can modify the standard equation ($C_t = C_0 \times e^{-Kt}$) to obtain this. If we consider the first of our two samples, we can model the exponential decline in concentration from C_0 to C_1 over the time period T_1 as:

$$C_1 = C_0 \times e^{-K.T_1} \text{ and so ...}$$

$$C_0 = C_1 / e^{-K.T_1}$$

Consider this example scenario: A patient has received 100mg of drug by i.v. bolus injection and blood samples were taken at 1 and 8 hours post dosing and these were found to contain drug concentrations of 5mg/L and 1mg/L respectively. We can obtain K and V for the patient as follows:

$$\begin{aligned} K &= \text{Ln}(C_1/C_2) / (T_2 - T_1) \\ &= \text{Ln}(5\text{mg/L} / 1\text{mg/L}) / (8\text{h} - 1\text{h}) \\ &= \text{Ln}(5) / 7\text{h} \\ &= 1.61 / 7\text{h} \\ &= 0.23\text{h}^{-1} \end{aligned}$$

$$\begin{aligned}
 C_0 &= C_1 / e^{-K \cdot T_1} \\
 &= 5\text{mg/L} / e^{-0.23\text{h}^{-1} \times 1\text{h}} \\
 &= 5\text{mg/L} / e^{-0.23} \\
 &= 5\text{mg/L} / 0.794 \\
 &= 6.30 \text{ mg/L}
 \end{aligned}$$

$$\begin{aligned}
 V &= D/C_0 \\
 &= 100\text{mg} / 6.30\text{mg/L} \\
 &= 15.9\text{L}
 \end{aligned}$$



An Excel spreadsheet is available to automate the calculation of K and V from two observations of drug concentration. Go to www.phrData.co.uk then click on 'Pharmacokinetics' and then on 'K and V from two points'

6.3 Practice calculations

- 1) A patient has received a dose of 15mg of a drug by bolus i.v. injection. Blood samples were taken at various times afterwards and analysed for drug concentration. The results are shown in Table 6.2.

Please click the advert

THE MILKROUND SYSTEM
LAUNCHING GRADUATE CAREERS

MILKROUND SYSTEM
Become a business star with internships, placements, graduate jobs & schemes from leading companies.
www.milkround.com

PLANET CAREER ADVICE
Inhabited by insights into business careers and orbited by application advice.

FIRST CONTACT
Get matched to top business employers via intelligent emails landing in your inbox.

Milkround.com: rated the #1 graduate recruitment website in the UK Graduate Careers Survey 2009 of 16,000 university finalists.

Milkround.com

Download free ebooks at bookboon.com

| Time (h) | Concentration (ng/mL) |
|----------|-----------------------|
| 4 | 152 |
| 8 | 128 |
| 14 | 74 |
| 20 | 44 |
| 28 | 24 |

Table 6.2 Drug concentrations at various times following 15mg i.v. bolus injection

Use the sheet of blank semi-log graph paper (Next page) to plot the data, fit a line by eye and calculate V , K and clearance.

The Practice calculations section in Chapter 13 (Section 13.2) invites you to re-analyse the data using a computerized approach.

- 2) A patient received a dose of 120mg of drug by bolus i.v. injection. Blood samples were taken at 2 and 12 hours post dosing and found to contain 7.1 and 0.8mg/L of drug respectively. Using formulae only (not a graph) calculate K and V for this patient.
- 3) Repeat the calculation of question 2, using the spreadsheet available from www.phrData.co.uk. Click 'Pharmacokinetics' and then 'K and V from two points'. Does this agree with your manual calculation?

Answers are available in the final section of the book.

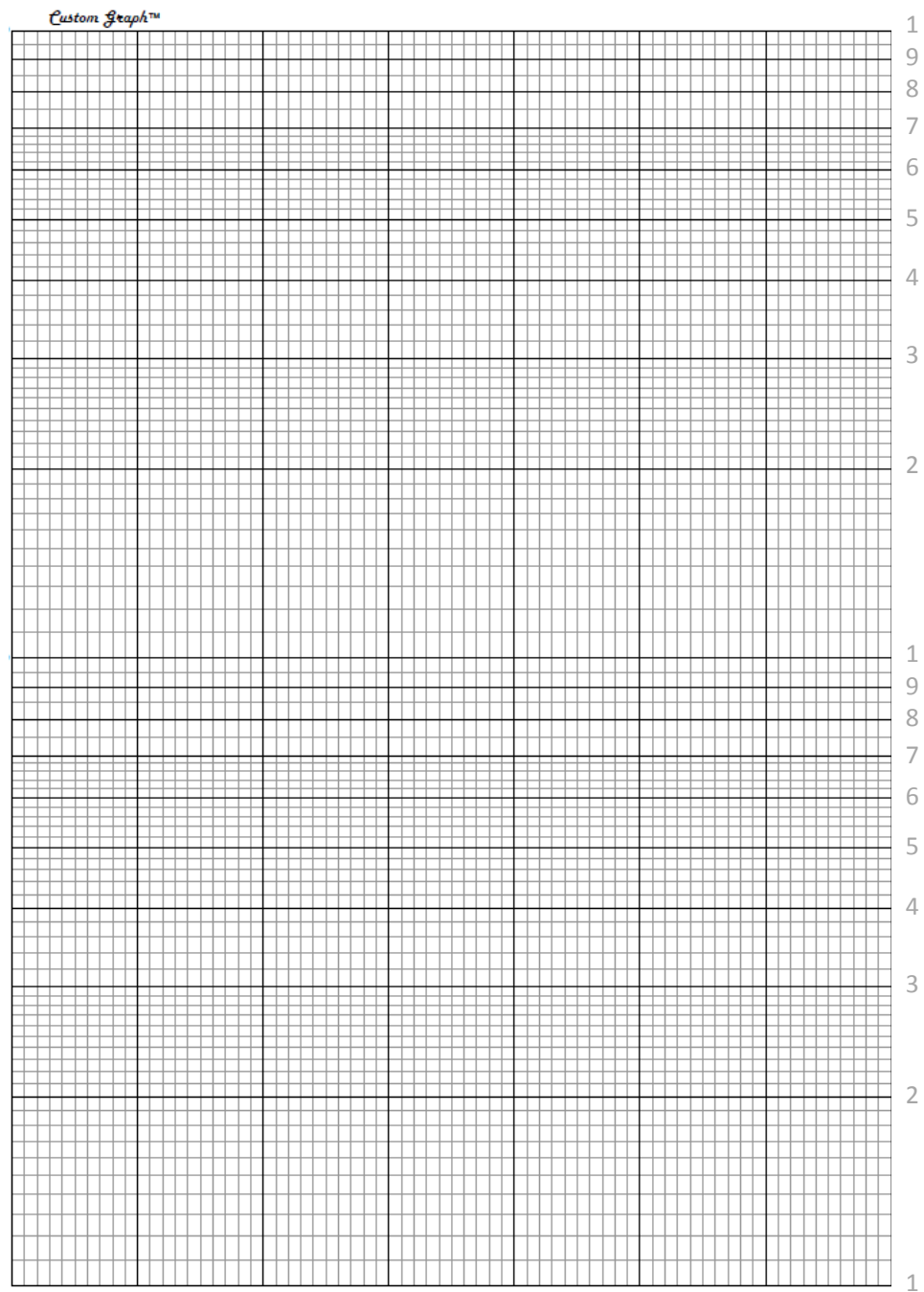

This sheet of semi-log graph paper can be used to answer Question (1).

6.4 Appendix 1

We know that falling drug concentration can be described by the equation:

$$C_t = C_0 \times e^{-Kt}$$

If we take the natural logs of both sides of the equation we get ...

$$\ln(C_t) = \ln(C_0) - K.t$$

This can then be re-arranged to:

$$\ln(C_t) = -K . t + \ln(C_0)$$

This is now in the same form as the general equation of a straight line

$$Y = m . X + c$$

| | | | | | | | |
|------------------|---------------------|---|----|---|---|---|---------------------|
| General equation | Y | = | m | . | X | + | c |
| This case | Ln(C _t) | = | -K | . | t | + | Ln(C ₀) |

Thus

Y (the value plotted up the vertical axis) will be Ln(C_t)

m (the gradient of the line) will be -K

X (the value plotted along the horizontal axis) will be t

c (the intercept on the vertical axis) will be Ln(C₀)

Please click the advert

“ Top legal people rate The Open University ”

...and some of them are pretty good judges

Raise the bar with top legal courses

Developed in partnership with The College of Law

The College of Law
of England and Wales

Boost your legal career

▶ Find out more

INSPIRING LEARNING



The Open University



So, if instead of plotting the concentration, we plot the natural log of the concentration versus time, we should obtain a straight line relationship. Figure 6.7 uses the data from Table 6.1 and shows an essentially linear pattern.

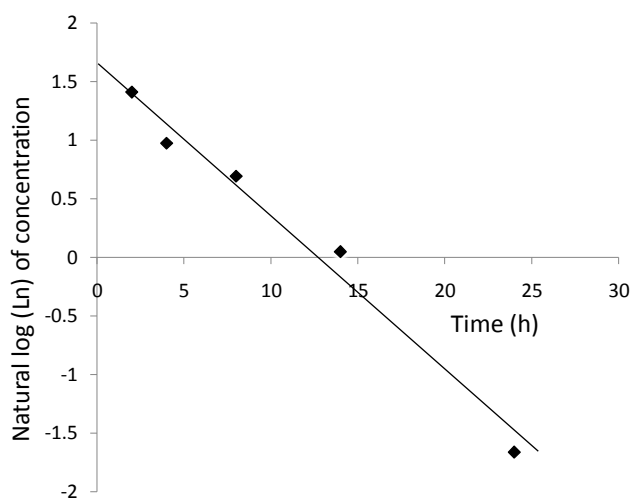

Figure 6.7 Linearization of the data by plotting the natural log of the concentration versus time.

In the above discussion we have used natural logs, but in fact using the more familiar, base 10 logs will also linearize the data; the gradient would however change.

As a final simplification, we can avoid having to calculate the logs of the concentrations. We can instead use graph paper with a logarithmic vertical scale and plot the actual observed concentration directly. This was shown in Figure 6.2.

6.5 Appendix 2

Derivation of the equation $K = \text{Ln}(C_1/C_2) / (T_2 - T_1)$

Consider the exponential decline in drug concentration from C_1 to C_2 over the intervening period of time $(T_2 - T_1)$. This can be expressed in the format of the standard exponential equation as:

$$C_2 = C_1 \times e^{-K(T_2 - T_1)}$$

$$C_2/C_1 = e^{-K(T_2 - T_1)}$$

(Take natural logs of both sides)

$$\text{Ln}(C_2/C_1) = -K \times (T_2 - T_1)$$

$$\text{Ln}(C_2/C_1) / (T_2 - T_1) = -K$$

$$-K = \text{Ln}(C_2/C_1) / (T_2 - T_1)$$

$$K = -\text{Ln}(C_2/C_1) / (T_2 - T_1)$$

(As $-\text{Ln}(x) = \text{Ln}(1/x)$)

$$K = \text{Ln}(C_1/C_2) / (T_2 - T_1)$$

7 Single intravenous bolus injection into two compartments

7.1 The model to be considered

All parts of this chapter, apart from the final section (7.5) will be relevant to both drug development and clinical practice. The last section is aimed at clinical practice.

Figure 7.1 summarizes the situation we will be considering.

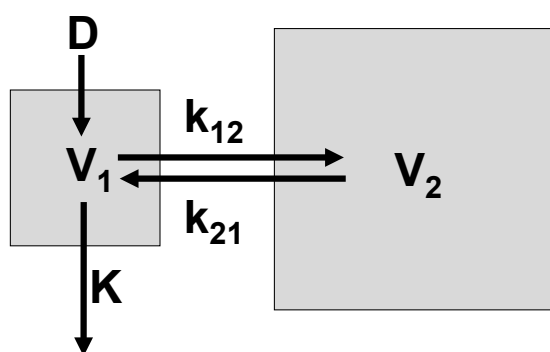

Figure 7.1 Schematic representation of a single i.v. bolus injection into two compartments

This scenario is one step more complex than that considered in Chapter 5. There is still no absorption phase to concern us (i.v. injection direct into blood stream) but there is now the addition of an extra compartment. Drug will move into this second compartment (and also back again) at a relatively slow rate.

Each compartment has its own volume of distribution (V_1 & V_2). V_{ss} (Volume at steady state) is often quoted as the total volume of the system. It is simply the sum of $V_1 + V_2$. V_β is used as an alternative measure of total volume, and is calculated in a different manner.

The rate constants k_{12} and k_{21} (pronounced kay-one-two and kay-two-one, not kay-twelve and k-twenty-one!) govern the rate of drug distribution from the first to the second compartment (k_{12}) and vice versa (k_{21}).

7.2 Drug concentrations in blood and the rest of the first compartment

Figure 7.2 shows the blood concentration versus time curve for a single i.v. bolus injection into two compartments. We will consider what is happening to the drug at three time points - Early middle and late. These are marked as A, B & C. At each time point there is small representation of the current situation. The depth of shading of the two compartments indicates the amount of drug present (Darkest = most drug). The width of the arrows showing movement between compartments, indicates the amount of drug moving in the relevant direction (Thickest = most movement). At all times, elimination will be occurring from the 1st compartment and this is also indicated.

Shortly after injection (A) virtually all the dose is still in compartment 1, as there has been insufficient time for any significant proportion of the dose to distribute into compartment 2. There will be a marked disequilibrium between the compartments and the rate of movement of drug from compartment 1 to 2 will be much greater than that in the opposite direction. Hence there will be net movement from compartment 1 to 2. Drug elimination will also be occurring. So, at this early time, there are two processes (redistribution and elimination) both of which are removing drug from the first compartment. Consequently, we see a very fast fall in the concentration of drug in this compartment. As blood forms part of the 1st compartment, we see a rapid drop in blood concentrations at this early stage.

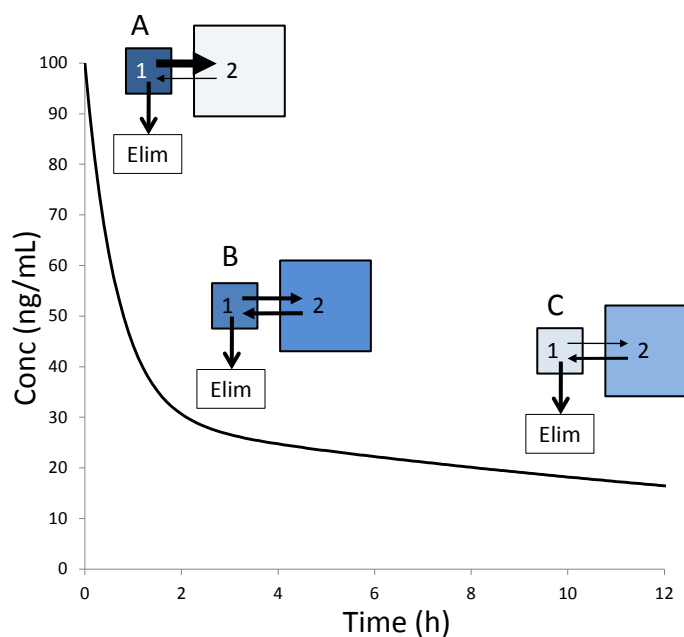

Figure 7.2 Concentration versus time curve for a single i.v. bolus injection into two compartments.

Later (B), concentrations in compartment 1 will have fallen and those in 2 will have risen and there will be a moment of equilibrium. Drug will be moving in both directions, but there will be no net movement. We now have just one process (elimination) removing drug from the first compartment, so the graph now falls more gently.

At time point C, continuing drug elimination from the first compartment will have caused a new disequilibrium, but now it is the 2nd compartment that has higher concentrations, so net movement will be from compartment 2 back to 1. We now have two processes affecting the amount of drug in compartment 1; elimination is removing drug from this compartment, but re-equilibration is moving drug back in. The rate of decline of concentration in compartment 1 is therefore very slow at this late stage, since all we now see is the balance between the two processes – the extent to which elimination exceeds redistribution. This is summarized in Table 7.1

| Stage | Effect of elimination | Effect of re-distribution | Overall effect on concentration |
|------------|-----------------------|---------------------------|---------------------------------|
| Early (A) | Reduce | Reduce | Rapid decline |
| Middle (B) | Reduce | None | Moderate decline |
| Late (C) | Reduce | Increase | Slow decline |

Table 7.1 The effects of elimination and re-distribution on the amount of drug in the blood and the rest of the first compartment and their overall effect on drug concentration.

7.3 Determining how many compartments a drug occupies

The practical indication of how many compartments a drug occupies is the shape of the semi-log graph of concentration versus time. We have already seen (Figure 6.2) that with one compartment, the log concentration versus time graph forms a simple straight line. However, when a second compartment is present, this will distort the picture and concentrations will fall faster in the initial period and slower in the later period than would have been the case with just one compartment. Figure 7.3 shows the contrast. With two compartments we see a distinctive dog-leg bend in the graph instead of a simple straight line.

Please click the advert



Sharp Minds - Bright Ideas!

Employees at FOSS Analytical A/S are living proof of the company value - First - using new inventions to make dedicated solutions for our customers. With sharp minds and cross functional teamwork, we constantly strive to develop new unique products - Would you like to join our team?

FOSS works diligently with innovation and development as basis for its growth. It is reflected in the fact that more than 200 of the 1200 employees in FOSS work with Research & Development in Scandinavia and USA. Engineers at FOSS work in production, development and marketing, within a wide range of different fields, i.e. Chemistry, Electronics, Mechanics, Software, Optics, Microbiology, Chemometrics.

We offer
A challenging job in an international and innovative company that is leading in its field. You will get the opportunity to work with the most advanced technology together with highly skilled colleagues.

Read more about FOSS at www.foss.dk - or go directly to our student site www.foss.dk/sharpminds where you can learn more about your possibilities of working together with us on projects, your thesis etc.

The Family owned FOSS group is the world leader as supplier of dedicated, high-tech analytical solutions which measure and control the quality and production of agricultural, food, pharmaceutical and chemical products. Main activities are initiated from Denmark, Sweden and USA with headquarters domiciled in Hillerød, DK. The products are marketed globally by 23 sales companies and an extensive net of distributors. In line with the corevalue to be 'First', the company intends to expand its market position.

Dedicated Analytical Solutions

FOSS
 Slangerupgade 69
 3400 Hillerød
 Tel. +45 70103370
www.foss.dk



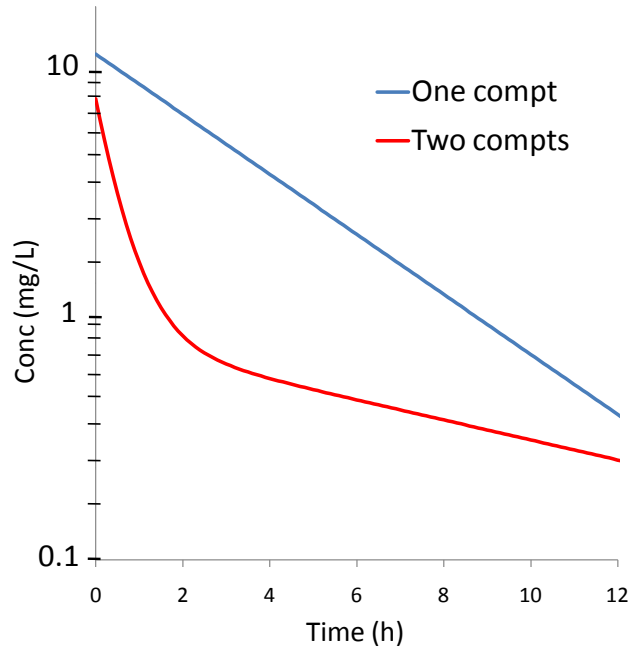

Figure 7.3 Semi-log plot of drug concentration versus time for drugs that occupy one or two compartments



The practical method for distinguishing a one from a two compartment drug, is to inspect a semi-log graph of concentration versus time. A straight line is indicative of one compartment; a curve implies two.

7.4 Drug concentration in the second compartment

Figure 7.4 is similar to 7.2 but it adds in the pattern of drug concentration in the second compartment.

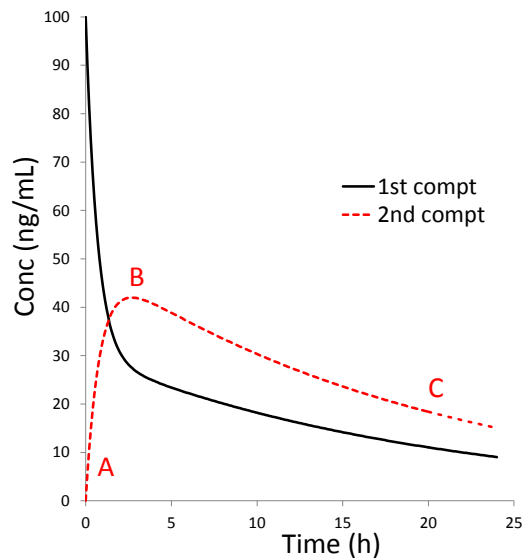

Figure 7.4 Drug concentrations in the two compartments following a single i.v. bolus injection

The three stages of the process were characterized by (A) movement of drug from compartment 1 to 2, (B) no movement and finally (C) a return of drug to the first compartment. The amount of drug in the second compartment reflects this.

- a) We start with virtually no drug in the second compartment, but re-equilibration moves drug in – levels rise
- b) A brief equilibrium - no net movement – at the peak of the curve, levels are neither rising nor falling
- c) Re-equilibration moves into reverse and drug leaves the second compartment – levels fall

7.5 Two compartment systems and therapeutic drug monitoring for digoxin

Therapeutic drug monitoring (TDM) is the process in which blood samples are taken from patients to determine concentrations of drugs for which levels have to be controlled within specified ranges. Dose sizes and/or dosage intervals can then be adjusted if levels are found to be too high or low. The logical basis of the practice is that blood concentrations will reflect levels in the tissues where the drug has its action and thus blood levels will correlate with therapeutic effect. For most drugs this works well enough. However, there is a potential problem with monitoring blood levels of digoxin.

In Section 3.3 we met the principle that the rate of drug distribution from blood to tissues usually depended upon tissue perfusion, but it was pointed out that polar drugs would have limited lipid solubility and might enter tissues rather slowly even when there was a rich blood supply. Digoxin is the classic problem drug. It does eventually distribute into tissues, but it does so slowly.

For the reasons explained above, digoxin entry into cardiac muscle is slow despite this tissue being well perfused. Consequently this tissue forms part of the second compartment for digoxin. Given that digoxin acts on cardiac muscle and this is within the second compartment, there is no direct link between blood levels (part of the first compartment) and the therapeutic effect of digoxin. It is concentration in the second compartment that will be directly linked to outcome.

There is no practical way by which we can sample from the second compartment, so we have to rely upon blood samples, but special precautions are required. Figure 7.5 shows a very early (20 minutes) blood sample being taken (Indicated by the vertical dotted line). Such an early sample would contain very high digoxin levels (possibly apparently toxic) and yet the therapeutic response at that time will be less dramatic, as it is governed by the much lower concentration in the second compartment. It is almost impossible to interpret a sample taken in the first few hours when blood levels are falling, but concentrations within the relevant tissues are rising.

From about 6 hours onwards, matters change and there is now a steady ratio between blood and tissue concentrations. It is now possible to define a range of blood concentrations that will be associated with tissue concentrations that assure an appropriate therapeutic effect. At these later times, high blood levels would be associated with excessive effect and low levels with inadequate effect. It is therefore a general rule that blood samples for therapeutic drug monitoring of digoxin should not be taken less than 6 hours post dose.

This problem is unlikely to arise with more lipid soluble drugs as they move quickly into well perfused tissues and blood levels correlate with therapeutic effect at all times.

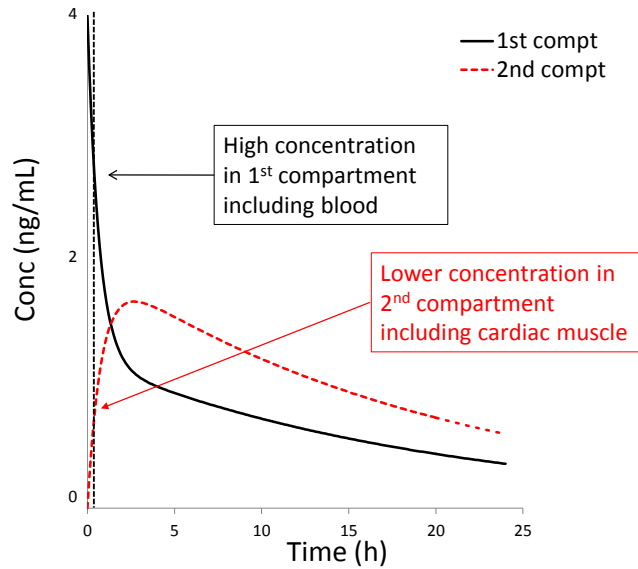

Figure 7.5 An excessively early blood sample for therapeutic drug monitoring of digoxin.



Blood samples for therapeutic drug monitoring of digoxin are normally taken at least 6 hours post dosing.

Please click the advert

The Wake

the only emission we want to leave behind

Low-speed Engines Medium-speed Engines Turbochargers Propellers Propulsion Packages PrimeServ

The design of eco-friendly marine power and propulsion solutions is crucial for MAN Diesel & Turbo. Power competencies are offered with the world's largest engine programme – having outputs spanning from 450 to 87,220 kW per engine. Get up front! Find out more at www.mandieselturbo.com

Engineering the Future – since 1758.

MAN Diesel & Turbo



Download free ebooks at bookboon.com

8 Constant intravenous infusion

The contents of this chapter are relevant to both drug development and clinical practice.

8.1 The model to be considered

When a drug is administered by infusion, it is generally prepared in a sterile saline solution (probably in a flexible plastic bag) and a cannula runs from this bag, via a constant rate infusion pump, into a patient's vein. The pump delivers drug solution directly into the blood stream at a steady rate over several hours or days.

Figure 8.1 shows the input into the patient with the rate of infusion represented as ' R_{inf} '. This is assumed to be a fixed figure that does not vary over time. The rate of elimination of drug from the patient 'Output' will, as usual, depend upon the elimination rate constant and the mass of drug in the patient available for elimination. The former (K) is essentially non-varying, but the mass of drug will vary during the infusion process, therefore the rate of output is variable.

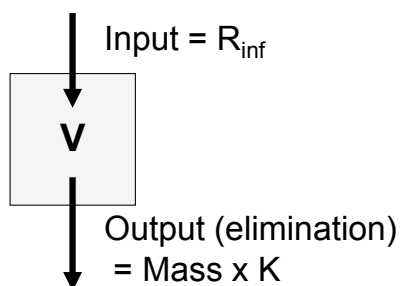

Figure 8.1 Schematic representation of constant intravenous infusion

8.2 Concentration versus time curve during infusion

To understand the concentration versus time curve for this process (Figure 8.2) we always need to consider the balance between input and output. If these are equal, the body load (and hence blood concentration) of drug will remain constant, but if they are unequal, blood levels will rise or fall. Three time points (Early, Middle and Late) are highlighted as (A), (B) & (C).

Point (A) is very early in the process and little drug has, as yet, been delivered. A low body load of drug implies a low rate of elimination. So, at point A the rate of elimination is much less than (\ll) the rate of infusion. There is a strongly positive balance and blood levels rise rapidly at this early stage.

By the time we reach Point (B), body load of drug have risen considerably and the rate of elimination will also have increased. However, it can be seen that blood levels are still rising, so evidently the rate of elimination is still somewhat less than ($<$) that for infusion.

Finally, at (C), the body load has risen sufficiently for the rate of elimination to match that of infusion. From this point on, the two processes are in balance and blood levels settle down. This situation is referred to as 'Steady state' and the associated blood concentration is 'Concentration at steady state' or C_{ss} .

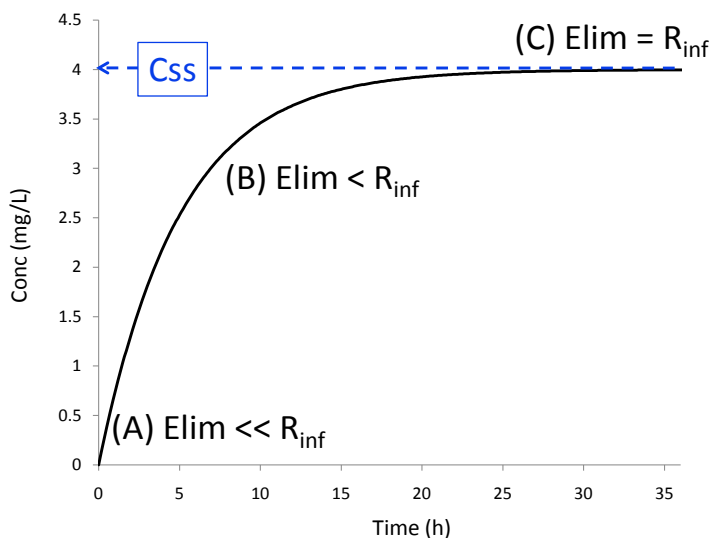

Figure 8.2 Balance between rates of elimination and infusion at various time points



'Steady state' is the condition where the rate of drug entry into the body is balanced by the rate of elimination and no further accumulation occurs.

8.3 Relationship between rate of infusion and concentration at steady state

8.3.1 Calculation of C_{ss} or rate of infusion

The key relationship is that between C_{ss} and the rate of infusion. The relevant equation is shown below and its derivation is given in an appendix to this chapter:

$$C_{ss} = R_{inf} / Cl$$

In the clinical situation, the real need is often to calculate an appropriate rate of infusion in order to obtain some specified target concentration and so we use the re-arranged equation:

$$R_{inf} = C_{ss} \times Cl$$

The equations quoted above are described as 'General'. In other words they are not dependent upon whether the drug occupies one or two compartments; they are universally applicable.

8.3.2 Determination of clearance as part of the drug development process

Because the equation linking C_{ss} to R_{inf} is general, infusion offers a definitive method for the measurement of clearance. If it is possible to arrange to deliver a new drug by infusion for a period long enough to achieve steady state, a re-arranged form of the standard equation (below) can be used to determine clearance:

$$Cl = R_{inf} / C_{ss}$$

Clearance values obtained by this method are free of any considerations as to how many compartments the drug might occupy.

8.4 Loading doses

8.4.1 Loading dose where drugs are treated as occupying one compartment

In Figure 8.3, the useful therapeutic range of a drug is between 3 and 5 mg/L and this is indicated by shading. Concentrations below or above this range are likely to be either ineffective or toxic respectively. With a simple infusion (indicated as 'No loading dose') the patient will achieve an inadequate therapeutic effect for approximately the first six hours of treatment. With some drugs this might be tolerable. However, with an anti-asthmatic drug such as theophylline (which may be given by infusion) we certainly could not leave the patient unable to breathe properly for such a long time.

Please click the advert

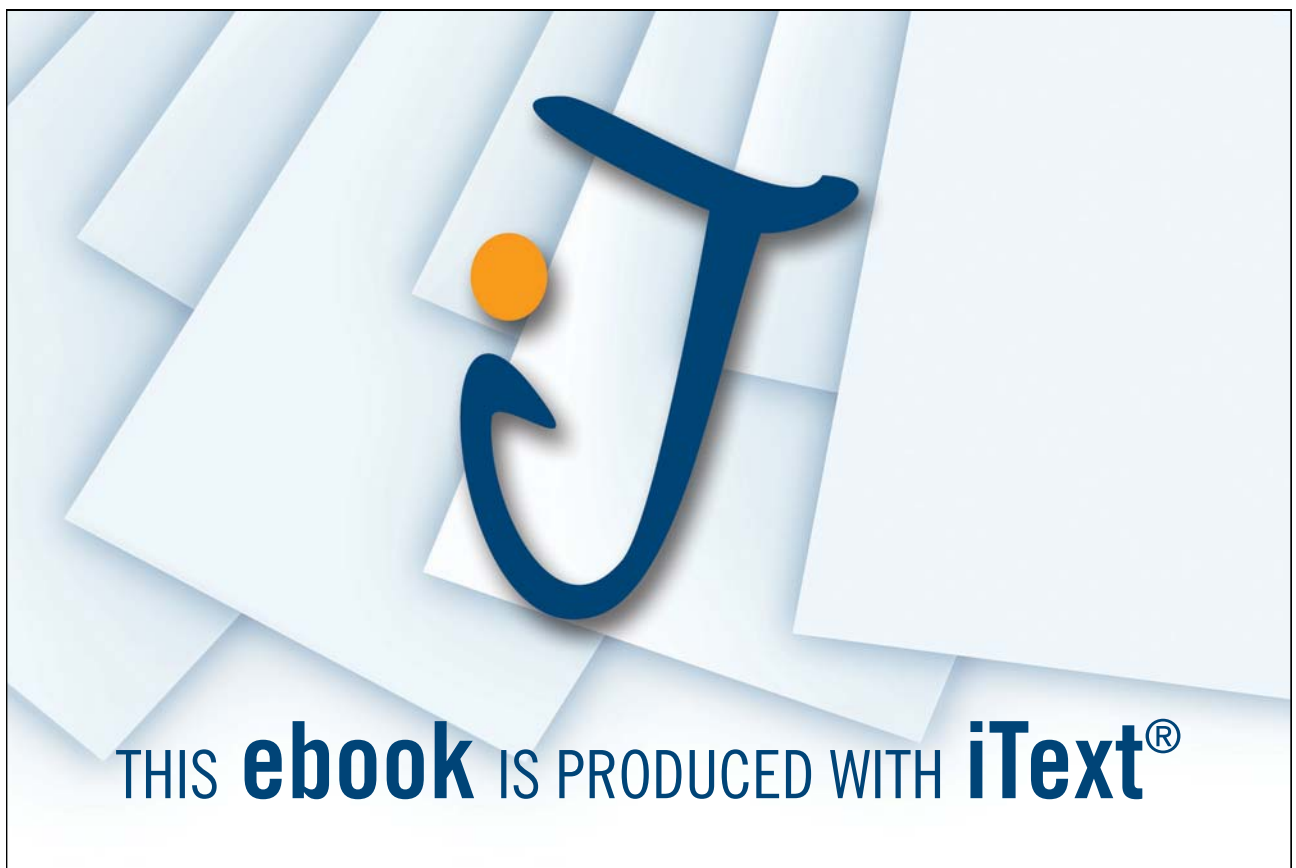

Download free ebooks at bookboon.com

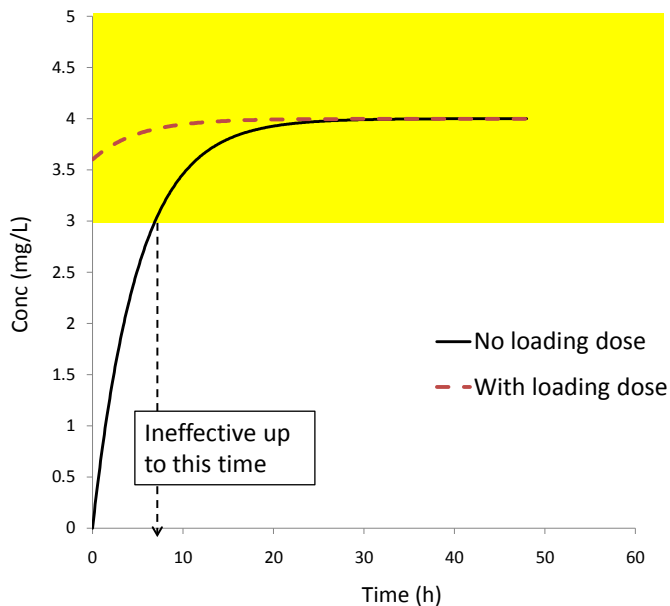



Figure 8.3 The purpose of supplementing an infusion with a loading dose

The solution to this problem is to precede the infusion with a ‘Loading dose.’ This is a single i.v. bolus dose calculated to bring blood levels immediately into the therapeutic range and then the infusion acts to maintain those levels. This is shown in the upper trace labelled ‘With loading dose.’

| | |
|---|---|
|  | <p>‘Loading doses’ are used to achieve effective blood levels of drug rapidly, without having to wait for the drug to accumulate.</p> |
|---|---|

We have already seen the simple, general relationship:

$$\text{Concentration} = \text{Dose} / V$$

This can be re-arranged to:

$$D = C \times V$$

A loading dose (LD) is just a specific example of a dose and there is a target concentration we wish to achieve, so:
 $LD = \text{Target} \times V$.

For an i.v. infusion, bioavailability is not an issue; F is automatically equal to 1.0. However, we will meet loading doses in other settings, where drugs are administered orally and then F does have to be incorporated. To avoid having two separate equations for loading dose, we will include F, but remember that for i.v. infusion this simply takes the value 1.0. The general equation is:

$$LD = \text{Target} \times V / F$$

The other potential complication is that the drug may be given as a salt (e.g. theophylline administered as aminophylline), in which case the salt factor must also be included:

$$LD = \text{Target} \times V / (F \times S)$$

8.4.2 An example

A patient weighs 60Kg and is to receive a loading dose plus infusion of aminophylline. The target concentration range for theophylline is 10-20mg/L. Aminophylline contains 70% (w/w) of theophylline. The population mean volume of distribution and clearance of theophylline are 0.48L/Kg and 0.04L/h/Kg respectively.

Target = midrange = 15mg/L

$$\begin{aligned} V &= 0.48\text{L/Kg} \times 60\text{Kg} \\ &= 28.8\text{L} \end{aligned}$$

$$\begin{aligned} Cl &= 0.04\text{L/h/Kg} \times 60\text{Kg} \\ &= 2.4\text{L/h} \end{aligned}$$

Please click the advert



www.job.oticon.dk

oticon
PEOPLE FIRST

$$\begin{aligned} LD &= \text{Target} \times V / (F \times S) \\ &= 15\text{mg/L} \times 28.8\text{L} / (1.0 \times 0.7) \\ &= 617\text{mg} \end{aligned}$$

$$\begin{aligned} C_{ss} &= R_{inf} / Cl \\ R_{inf} (\text{theophylline}) &= C_{ss} \times Cl \\ &= 15\text{mg/L} \times 2.4\text{L/h} \\ &= 36\text{mg/h} \end{aligned}$$

$$\begin{aligned} R_{inf} (\text{aminophylline}) &= 36\text{mg/h} / S \\ &= 36\text{mg/h} / 0.7 \\ &= 51\text{mg/h} \end{aligned}$$

8.4.3 Loading dose where we have to recognize two compartments

The method of calculation of a loading dose shown above, works fine if the drug can be considered as occupying one compartment. However, some drugs have to be recognized as occupying two compartments and then there is a potential problem. Figure 8.4 shows the situation. Both the loading dose and the continuing infusion act as inputs.

Please click the advert

01001001 01010100
 00100000 01010100
 01110010 01100001
 01101001 01101110
 01100101 01100101

Sie sehen hier mehr als Nullen und Einsen?

Wir sehen Ihre Karriere im IT-Trainee-programm. Als spätere Fach- oder Führungskraft.

www.perspektiven.allianz.de

Allianz Karriere

Allianz 

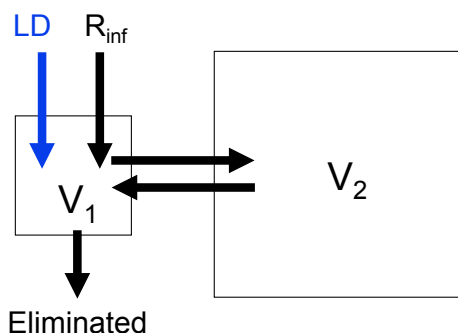

Figure 8.4 Infusion accompanied by a loading dose with a two compartment system.

The formula for calculating a loading dose takes account of the volume of distribution. But that raises the question, which volume? Should we use just V_1 or the complete volume of the system V_{ss} (i.e. $V_1 + V_2$)?

If we use the total, $V_1 + V_2$, we will arrive at a dose large enough to raise the concentration of the whole system to the target concentration. However, that dose will initially find itself constrained within just V_1 and therefore the initial concentration will be much higher than the target. The loading dose will eventually redistribute throughout the complete volume and drug concentrations will decline. Whether the initially high levels are a real problem depends upon how quickly the loading dose disperses and the potential of the drug to cause toxicity over the period prior to re-equilibration. For some drugs such as lidocaine, the problem is perfectly real and a loading dose calculated using the complete volume of the system would risk toxicity.

If alternatively, we calculate the loading dose using just V_1 , then the initial concentration in the first compartment (including blood levels) should match the target concentration. This is shown in Figure 8.5, where it is assumed that the target concentration is 4mg/L and that the shaded area (3-5mg/L) is the acceptable concentration range. Immediately after the injection, there will be a marked disequilibrium, with the whole dose in the first compartment and drug will move out of the first into the second compartment. This will cause the drop in concentrations shown in the early part of the graph. After a while enough drug will have moved over to the second compartment to achieve an equilibrium. Distributional loss of drug from the first compartment will then cease and the infusion will be able to return the concentration to C_{ss} .

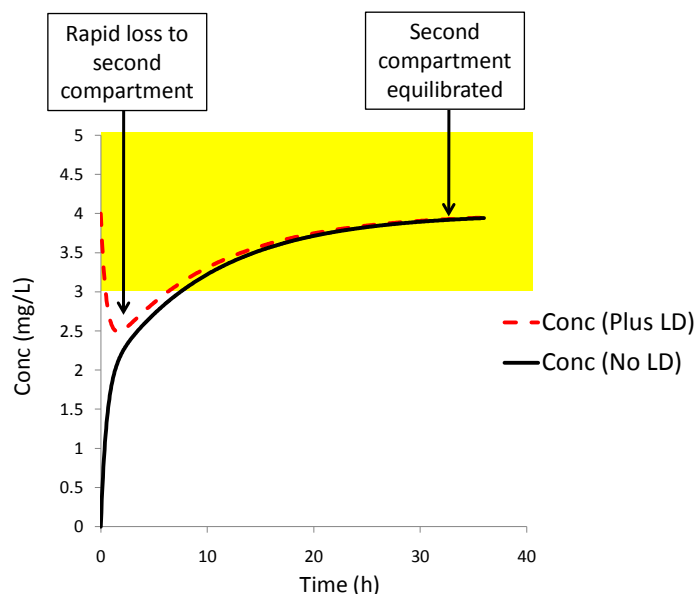

Figure 8.5 A loading dose calculated to provide enough drug to raise the concentration in the first compartment to the target level.

This approach may therefore lead to a temporary loss of adequate drug effect. If it is likely that this would cause real clinical problems, then there are two possible approaches:

- Give a small, additional loading dose a short time into the infusion when the dip in concentrations is anticipated.
- Use a rate of infusion higher than would generally be required during the period when the dip would otherwise occur and then revert to the normal rate for the rest of the infusion.

8.5 The accumulation period

For clinical purposes we are unlikely to want to calculate drug concentrations during the period of drug accumulation. However, it is useful to understand one aspect of this stage of the process.

Although it is somewhat counterintuitive, there is a relationship between a drug's accumulation during infusion and its elimination half-life. If the elimination half-life is T hours, then after infusing for a period of T hours, drug levels will accumulate to half of the eventual C_{ss} . This is shown in Figure 8.6 for a drug with an elimination half-life of about 3.4 hours. The number '1' indicates a time equal to one half-life and at this point concentration has risen to half of C_{ss} . The number '2' marks where the equivalent of two half-lives (6.8 hours) have passed and concentrations are three quarters of C_{ss} and finally at '3', we have reached seven eighths and so on. For practical purposes, we generally consider that drugs achieve C_{ss} within a period of time equivalent to three (or at the most four) half-lives.

An important (if rather unexpected) outcome of this relationship is that the infusion of a drug with a short elimination half-life will result in concentrations that move towards C_{ss} more rapidly than would be the case with a long half-life drug. Any drug with a long half-life (and consequently slow accumulation) is therefore particularly likely to require supplementation with a loading dose. On the other hand, a short half-life drug will accumulate rapidly and a loading dose is less likely to be essential.

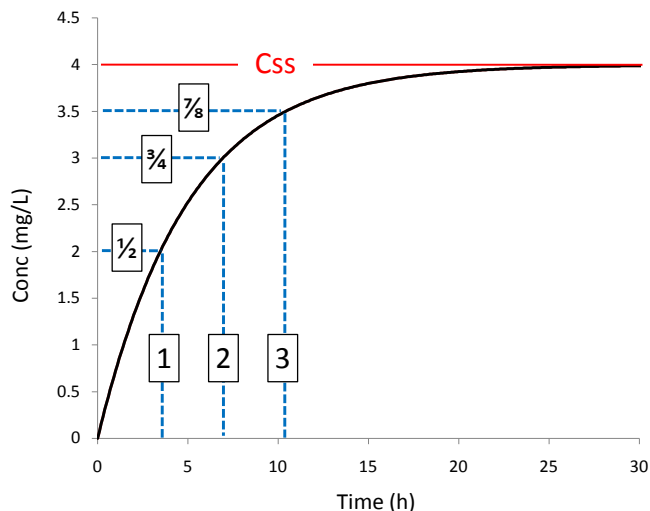

Figure 8.6 The relationship between a drug's elimination half-life and its accumulation during infusion.



When drug is allowed to accumulate for periods of time equal to one, two or three times the drug's elimination half-life, blood levels will reach 1/2, 3/4, 7/8 etc of the final steady state concentration.

Please click the advert

Turning a challenge into a learning curve. Just another day at the office for a high performer.

Accenture Boot Camp – your toughest test yet

Choose Accenture for a career where the variety of opportunities and challenges allows you to make a difference every day. A place where you can develop your potential and grow professionally, working alongside talented colleagues. The only place where you can learn from our unrivalled experience, while helping our global clients achieve high performance. If this is your idea of a typical working day, then Accenture is the place to be.

It all starts at Boot Camp. It's 48 hours that will stimulate your mind and enhance your career prospects. You'll spend time with other students, top Accenture Consultants and special guests. An inspirational two days

packed with intellectual challenges and activities designed to let you discover what it really means to be a high performer in business. We can't tell you everything about Boot Camp, but expect a fast-paced, exhilarating

and intense learning experience. It could be your toughest test yet, which is exactly what will make it your biggest opportunity.

Find out more and apply online.

Visit accenture.com/bootcamp

• Consulting • Technology • Outsourcing



8.6 Practice questions

- 1) A drug has a target concentration of 15mg/L and an estimated volume of distribution of 42 litres and clearance of 5L/h. The drug is to be administered as a salt containing 75% by weight of the parent drug. Recommend a loading dose and rate of infusion for the salt.
- 2) A drug has an ideal concentration range of 2 to 8 microgram/L. Its population mean volume of distribution and clearance are 3 litres/Kg and 1.1 mL/min/Kg respectively. Recommend a loading dose and a rate of infusion for the drug (in units of mg and microgram/h respectively) for a patient weighing 70Kg.
- 3) A drug is infused at a rate of 100 microgram/h. It has an estimated volume of distribution and clearance of 50 litres and 200 mL/min respectively. What will be the drug concentration at steady state?
- 4) For the infusion in the previous question, at what time will drug concentration rise to 4.15 microgram/L?
- 5) A drug is infused at a rate of 10mg/h. The estimated volume of distribution and clearance of the drug is 45 litres and 2 L/h respectively. What concentration will have been achieved 31.2 hours into the infusion?

Answers are available in the final section of the book.

8.7 Appendix

Derivation of the equation $C_{ss} = R_{inf} / Cl$

At steady state, input (R_{inf}) and elimination are equal, so ...

R_{inf} = Rate of elimination

The rate of elimination at steady state will equal the mass of drug present at steady state (M_{ss}) times the elimination rate constant: $M_{ss} \times K$. We can substitute this into the previous equation giving:

$$R_{inf} = M_{ss} \times K$$

This can be re-arranged to ...

$$M_{ss} = R_{inf} / K$$

Dividing both sides by V gives ...

$$M_{ss}/V = R_{inf} / (K \times V)$$

The left-hand term (mass present at steady state divided by the volume) will be the concentration at steady state and $K \times V$ is equal to clearance, so ...

$$C_{ss} = R_{inf} / Cl$$

9 Extravascular administration

Sections 9.1 to 9.3 are relevant to both drug development and clinical practice. Further sections are primarily relevant only to drug development.

9.1 The situation to be considered

In Chapters 5-8 we considered only intravenous administration. This chapter covers all other routes such as oral, intramuscular, subcutaneous etc. These routes bring additional complications:

- Absorption from the site of administration into the blood adds an extra stage to drug handling.
- Bioavailability is no longer automatically 100%; there may be losses prior to or during this absorption stage.

By far the most commonly used extravascular route is oral administration and this will be referred to at several points in this chapter. However, it should be borne in mind that the same general principles apply to all forms of extravascular administration.

9.2 Concentration versus time curve

Figure 9.1 summarizes the movement of drug into and out of the body after oral administration. On the left is a length of gut containing some drug that is still awaiting absorption (Amount awaiting – ‘Aa’). In the middle is the body, containing drug that has undergone absorption (Amount in body – ‘Ab’). Finally, drug is eliminated (Right hand side).

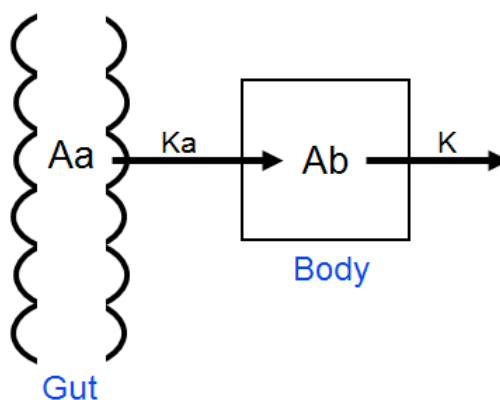

Figure 9.1 Schematic diagram of drug handling with oral administration

Two rate constants are involved:

K is the familiar elimination rate constant. K_a is the ‘Absorption rate constant’. There is an assumption that the rate of drug absorption is directly proportional to the amount of drug awaiting absorption and K_a links rate of drug absorption to mass of drug available:

Rate of absorption = $A_a \times K_a$

Although Figure 9.1 shows drug waiting to be absorbed from the gut, the same principles would apply to absorption from a depot of drug in a muscle or under the skin etc.

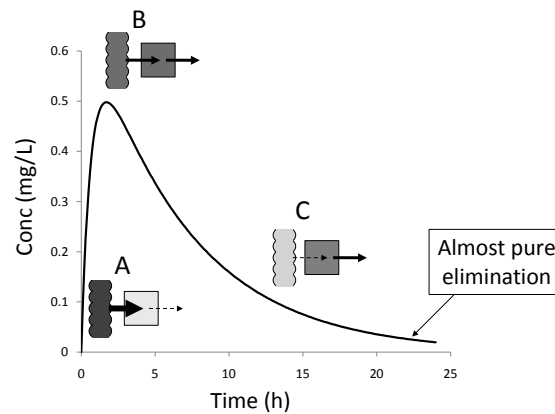

Figure 9.2 Concentration versus time curve for extravascular administration

Figure 9.2 shows the concentration versus time curve for extravascular administration. Miniature versions of Figure 9.1 are shown at early, middle and late stages (A, B & C). Level of shading represents the amount of drug in the gut or body at that time. The width of the arrows indicates the rate of drug absorption or elimination.

Please click the advert

Join the Vestas Graduate Programme

Vestas

Experience the Forces of Wind
and kick-start your career

As one of the world leaders in wind power solutions with wind turbine installations in over 65 countries and more than 20,000 employees globally, Vestas looks to accelerate innovation through the development of our employees' skills and talents. Our goal is to reduce CO₂ emissions dramatically and ensure a sustainable world for future generations.

Read more about the Vestas Graduate Programme on vestas.com/jobs.

Application period will open March 1 2012.

Wind. It means the world to us.™

Download free ebooks at bookboon.com

- At an early stage (A), there has been insufficient time for much absorption to occur and so most of the dose is still in the gut, with very little in the body. There is therefore plenty of drug in the gut to drive the absorption process (Large arrow), but very little in the body to drive elimination (Small arrow). With the rate of absorption greatly exceeding the rate of elimination, there is a strongly positive net balance for the amount of drug in the body and the concentration graph rises rapidly.
- There is then a period during which the amount left in the gut is steadily declining and therefore the rate of absorption is also falling. At the same time, the body load and rate of elimination are rising. We reach the point (B) where the rates of absorption and elimination become equal. This is the peak of the graph.
- In the final stage (C), relatively little drug is left in the gut and the rate of absorption no longer matches that for rate of elimination, so there is now a negative net balance and blood levels decline.

At all three points, the two processes of absorption and elimination are occurring in parallel; all that changes is the balance between the two and there is never pure absorption or elimination. The nearest we get to seeing just one process will be in the very late stages, where the rate of absorption may have become trivially small, leaving almost pure elimination. You may see the rising and falling parts of the graph referred to as the 'Absorption' and 'Elimination' stages. These terms are very questionable as they imply that the body first absorbs the drug and only when that process is complete does it then start eliminating it, which is certainly not the case.



Following an extravascular dose, the processes of absorption and elimination proceed in parallel. In the early phase, the rate of absorption exceeds that for elimination and blood levels rise. Later, elimination is predominant and levels fall.

9.3 Changing the rate of absorption

By changing the formulation of tablets and capsules, it is possible to manipulate the rate of release of drug from the dosage form and thereby control its rate of absorption. Figure 9.3 contrasts rapid and slow release forms of the same drug.

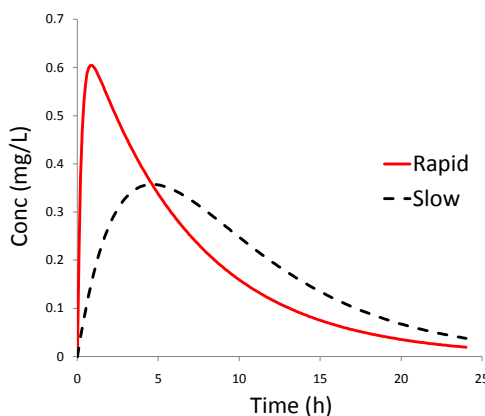

Figure 9.3 The effect of changing the rate of absorption from dosage formulations

Using a slow release dosage form causes three distinctive changes to the concentration/time profile:

- **A delayed peak:** Unsurprisingly, a delay in drug absorption causes a delay in the achievement of peak blood levels.
- **A lower peak:** If the drug is absorbed very rapidly, then most of the dose will move into the body within a short period and in this brief period only a small proportion of the dose will be eliminated. So, at the peak, the bulk of the dose will be present in the body, giving a high peak. However, with slow absorption, the process will take a significant amount of time to approach completion and by then, a considerable amount of drug will have been eliminated. Thus, even at the peak, only a fraction of the dose will be present. So the second difference is a lower peak.
- **Higher levels at later times:** The final contrast is seen at later times. Look at the period around 6 to 20 hours post dosing in Figure 9.3. With the rapid release form, the peak arrives early and so by this period we are well past the peak and levels have fallen greatly. However, with a slow release form, the peak arose more recently and levels have not fallen as much. Additionally, with slow absorption, it is likely that significant drug absorption is still occurring in this period, whereas with the rapid release form, that process has been largely completed well before. Hence, concentrations are supported by continued absorption at these later times with the slow release form.

The overall effect of a slow absorption formulation is a steady maintenance of moderate blood levels over an extended period, whereas rapid absorption forms produce a more fluctuating pattern with an early, high peak that then falls off quite rapidly.

Which of the two patterns shown in Figure 9.3 is preferable depends upon the therapeutic situation. If you woke up with a dreadful headache, you would probably welcome rapid absorption with a quick hit and high peak level of analgesic. Hopefully, you won't have any continuing need of the drug later in the day. However, if you are taking theophylline for your asthma, the pattern of sustained, moderate levels with a slow release formulation is far preferable. The rapid absorption profile would threaten early toxicity and/or a return of symptoms at later times.



Slow release formulations produce peak levels that are lower and occur later. They give prolonged, moderate drug levels, whereas rapid release forms give a high, early peak.

9.4 C_{max} and T_{max}

With extravascular administration, we need to consider two new parameters – C_{max} and T_{max}. These are the drug concentration at the peak and the time when the peak occurs. They are important parameters that need to be established in the development of any new drug or formulation. In Figure 9.2, C_{max} is about 0.5mg/L and T_{max} about 2 hours. Slow drug absorption is characterized by a reduction in C_{max} and an increase in T_{max} (Figure 9.3).

9.5 Determination of bioavailability for extravascular doses.

As part of the development of any new drug (or new dosage formulation) that is to be administered by an extravascular route, it will be important to determine its bioavailability. This section will use an example involving oral administration, but the same principle would apply to any extravascular route.

We will consider a trial where the same dose of a drug is administered to the same patient on two occasions, and the two administrations use either a different route or different dosage forms. There is a simple relationship between AUC and bioavailability (For derivation, see Appendix to this chapter):

$$\frac{F_1}{F_2} = \frac{AUC_1}{AUC_2}$$

F_1 and AUC_1 refer to the bioavailability and AUC for the first route or dosage form and F_2 and AUC_2 refer to the same parameters for the other product. There is a simple proportional relationship between bioavailability and AUC.

In our example, one dose will be administered orally and the other intravenously. We can therefore write a variant of the above formula, referring specifically to these routes:

$$\frac{F_{\text{oral}}}{F_{\text{iv}}} = \frac{AUC_{\text{oral}}}{AUC_{\text{iv}}}$$

However, we know that bioavailability by i.v. administration (F_{iv}) is always complete and takes the value 1.0, so we can eliminate this from the equation:

$$F_{\text{oral}} = \frac{AUC_{\text{oral}}}{AUC_{\text{iv}}}$$

Please click the advert



it's an **interesting** world

Get under the skin of it.

Graduate opportunities Cheltenham | £24,945 + benefits

One of the UK's intelligence services, GCHQ's role is two-fold: to gather and analyse intelligence which helps shape Britain's response to global events, and, to provide technical advice for the protection of Government communication and information systems. In doing so, our specialists – in IT, internet, engineering, languages, information assurance, mathematics and intelligence – get well beneath the surface of global affairs. If you thought the world was an interesting place, you really ought to explore our world of work.

www.careersinbritishintelligence.co.uk

Applicants must be British citizens. GCHQ values diversity and welcomes applicants from all sections of the community. We want our workforce to reflect the diversity of our work.



So, oral bioavailability can be determined very simply as the ratio of the two AUCs. Figure 9.4 shows a typical result from such a trial. The AUC_{oral} is about 50% of that from the i.v. route and so oral bioavailability is about 0.5.

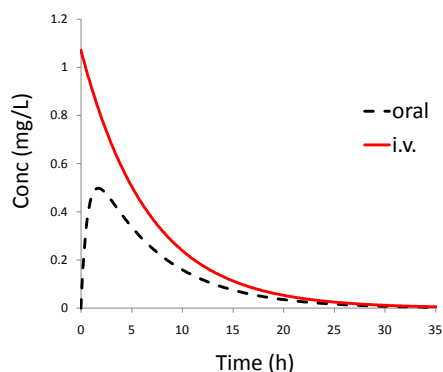

$$\frac{AUC_{oral}}{AUC_{i.v.}} = \text{Absolute oral bioavailability}$$

Figure 9.4 Determination of absolute oral bioavailability

9.5.1 Absolute bioavailability

In the previous example, one of the doses was administered i.v. and in such cases we refer to the result for the other dose as an ‘Absolute bioavailability’. The result tells us the actual fraction of the oral dose that reaches the general circulation.

9.5.2 Relative bioavailability

In other cases, neither dose may be intravenous. Figure 9.5, shows a comparison between capsule and tablet formulations (Again: same drug, same dose, same patient).

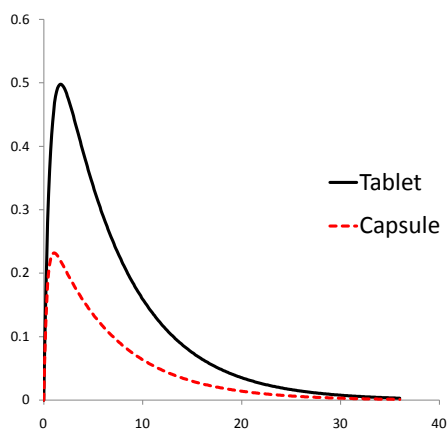

$$\frac{AUC_{Capsule}}{AUC_{Tablet}} = \text{Relative bioavailability for capsule (Relative to tablet)}$$

Figure 9.5 Determination of the relative bioavailability of a capsule formulation relative to that for a tablet

The capsule has delivered a lot less drug than the tablet; the AUC_{Capsule} is only about 60% of that for the tablet. We can say that the capsule delivers about 60% of the amount delivered by the tablet, but can we say exactly how much drug either method delivers? The answer is 'No'. It could be that the tablet delivers 100% of the dose and the capsule 60%, but it could also be that the tablet delivers 50% and the capsule 30% or the figures might be 10% and 6% - anything is possible. In the absence of an i.v. dose, it is not possible to determine exactly how much drug either dosage form delivers. Hence we talk in such cases, about 'Relative bioavailability'; we describe the efficiency of one dosage method relative to that for another.



When we compare the AUC from one route of administration against that following i.v. administration, the result is an absolute bioavailability. If neither dose is administered i.v., the result is a relative bioavailability.

9.6 Trapezoidal rule – A practical method to measure AUC

Figures 9.4 and 9.5 show blood concentrations as continuous curves, but real pharmacokinetic experiments yield concentrations at particular time points only. If one of the routes is i.v., we have already seen (Chapter 6) how to obtain the drug's clearance and then AUC_{iv} can be calculated as $AUC = D/Cl$. However, for extravascular doses, AUC cannot be obtained by any formula; graphical methods have to be used. Table 9.1 and Figure 9.6 show some example data following an oral dose of drug. The next few paragraphs describe a method to determine AUC_{oral} from such data.

| Time (h) | Conc (mg/L) |
|----------|-------------|
| 1 | 3.1 |
| 2 | 9.0 |
| 3 | 5.9 |
| 5 | 1.8 |
| 8 | 0.8 |
| 12 | 0.2 |

Table 9.1 Times and drug concentrations for blood samples following an oral dose.

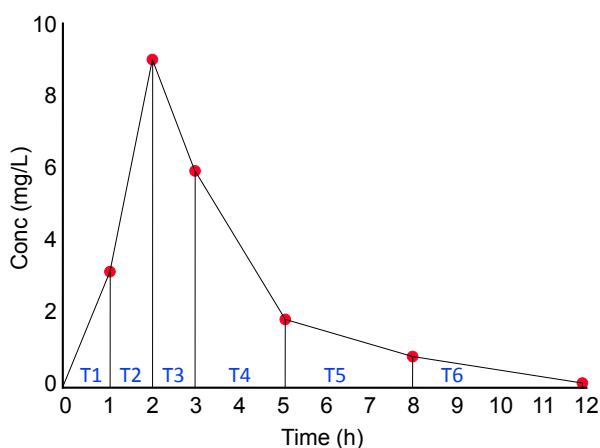

Figure 9.6 Use of the trapezoidal rule to determine AUC

A common method used to measure AUC based on these discrete observations is the ‘Trapezoidal rule’. In Figure 9.6, data-points have been joined by straight lines and verticals have been constructed from each data point down to the horizontal axis. This divides the area beneath the points into a series of trapezoids (Shapes with two parallel sides and two non-parallel). We then calculate the area of each individual trapezoid and use their sum to estimate AUC. The result is clearly an approximation, as the ideal value should be the area under a smooth curve. However, there are parts of the graph where the trapezoids somewhat overstate the true area and others where they understate it and overall, the result gives a reasonable approximation.

To calculate the area of each trapezoid, we need to determine its width and average height:

- The width is calculated as the difference between the start and end time for that trapezoid
- The average height is the average of the start and end concentration for the trapezoid

The area of each trapezoid is then its width multiplied by its average height.

Typically, no sample is taken at time zero, but with an extravascular dose, the initial concentration is known to be zero. We can therefore construct an additional trapezoid between origin of the graph and the first observed concentration. Figure 9.6 shows six trapezoids labelled as T1 to T6.

Table 9.2 shows the calculation of the widths, heights and areas of the six trapezoids and the total AUC_{0-12h} . The final figure is 28.65mg.h/L.

Please click the advert



Brain power

By 2020, wind could provide one-tenth of our planet's electricity needs. Already today, SKF's innovative know-how is crucial to running a large proportion of the world's wind turbines.

Up to 25 % of the generating costs relate to maintenance. These can be reduced dramatically thanks to our systems for on-line condition monitoring and automatic lubrication. We help make it more economical to create cleaner, cheaper energy out of thin air.

By sharing our experience, expertise, and creativity, industries can boost performance beyond expectations. Therefore we need the best employees who can meet this challenge!

The Power of Knowledge Engineering

Plug into The Power of Knowledge Engineering.
Visit us at www.skf.com/knowledge

SKF

Download free ebooks at bookboon.com

| Trapez no. | Start time (h) | End time (h) | Width (h) | Start conc (mg/L) | End conc (mg/L) | Average conc (mg/L) | Area (mg.h/L) |
|----------------------------|----------------|--------------|-----------|-------------------|-----------------|----------------------|------------------------|
| 1 | 0 | 1 | 1-0=1 | 0 | 3.1 | $(0+3.1)/2 = 1.55$ | $1 \times 1.55 = 1.55$ |
| 2 | 1 | 2 | 2-1=1 | 3.1 | 9.0 | $(3.1+9.0)/2 = 6.05$ | $1 \times 6.05 = 6.05$ |
| 3 | 2 | 3 | 3-2=1 | 9.0 | 5.9 | $(9.0+5.9)/2 = 7.45$ | $1 \times 7.45 = 7.45$ |
| 4 | 3 | 5 | 5-3=2 | 5.9 | 1.8 | $(5.9+1.8)/2 = 3.85$ | $2 \times 3.85 = 7.70$ |
| 5 | 5 | 8 | 8-5=3 | 1.8 | 0.8 | $(1.8+0.8)/2 = 1.30$ | $3 \times 1.30 = 3.90$ |
| 6 | 8 | 12 | 12-8=4 | 0.8 | 0.2 | $(0.8+0.2)/2 = 0.50$ | $4 \times 0.50 = 2.00$ |
| Total AUC _{0-12h} | | | | | | | = 28.65 |

Table 9.2 Calculation of AUC_{oral} by the trapezoidal rule for the period zero to 12 hours



An Excel spreadsheet is available to automate the calculation of AUC following extravascular administration. Go to www.phrData.co.uk, select 'Pharmacokinetics' and then 'Trapezoidal rule for AUC'.

There is an additional area beyond 12 hours that ought to be accounted for, if we are to produce a complete AUC from time zero to infinity. This remaining area is termed the 'Tail' and its area can be calculated from the final observed drug concentration (C_{final}) and K. The next few paragraphs describe how we can obtain a value for K, when a drug has been administered by an extravascular route.

In Section 9.2, we saw that for much of the time following an extravascular dose, the two processes of absorption and elimination occur in parallel, but at late times, absorption may be essentially complete and we see virtually pure elimination. This period can be identified by plotting data semi-logarithmically and looking for a late period where the data points form an essentially straight line – the 'Terminal linear portion'. Figure 9.7 shows this for the data in Table 9.1; the last three points form a terminal linear portion

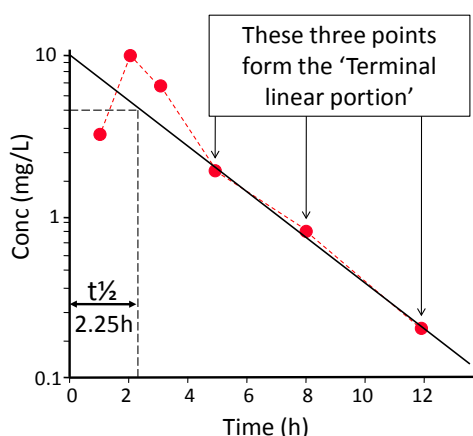

Figure 9.7 Drug concentrations versus time plotted semi-logarithmically to show the 'Terminal linear portion' where we see virtually pure elimination with no significant further absorption.

A line fitted through the terminal linear portion can be back-extrapolated to time zero and its half-life read in the usual way and then K is calculated from the half-life using the standard formula. The area of the tail is then calculated using the formula:

$$\text{Tail Area} = C_{\text{final}} / K$$

For the data currently under consideration, the half-life of the extrapolated line is 2.25h (See Figure 9.7). We then calculate:

$$\begin{aligned} K &= 0.693 / t_{1/2} \\ &= 0.693 / 2.25\text{h} \\ &= 0.308 \text{ h}^{-1} \end{aligned}$$

The drug concentration for the last blood sample was 0.2mg/L, so ...

$$\begin{aligned} \text{Tail Area} &= C_{\text{final}} / K \\ &= 0.2\text{mg/L} / 0.308\text{h}^{-1} \\ &= 0.65 \text{ mg}\cdot\text{h/L} \end{aligned}$$

The tail area is then added to the previous total from Table 9.2 to obtain the true complete AUC_{oral} :

$$\begin{aligned} \text{Full } AUC_{\text{oral}} &= AUC_{0-12\text{h}} + \text{Tail area} \\ &= 28.65 + 0.65 \text{ mg}\cdot\text{h/L} \\ &= 29.3 \text{ mg}\cdot\text{h/L} \end{aligned}$$

In this case, the final blood sample contained very little drug and the tail made only a minimal contribution to total AUC. The process of calculating tail areas is error prone and (as in the present case) studies should be designed to generate only small tail areas. We should certainly try to avoid stopping sampling when there is still a significant concentration of drug in the blood.

9.7 Practice question

- Chapter 6 included a question concerning blood levels following an i.v. dose (15mg) of drug from which it could be calculated that the clearance for the drug in that patient was 5.26L/h.

Use a formula (Not the trapezoidal rule) to calculate the AUC_{iv} for the i.v. dose.

The same patient also received an oral dose (15mg) of the same drug and blood samples were taken for analysis. The results are shown in Table 9.3. Use the trapezoidal rule to calculate the AUC_{oral} between zero and 24h.

Use semi-log graph paper (See Chapter 6 for a blank sheet) to plot the data. Identify the terminal linear portion and determine half-life, K , tail area and $AUC_{0-\infty}$.

Calculate oral bioavailability for the drug in this patient. Is the value calculated, an absolute or relative availability?

| Time (h) | Concentration (ng/mL) |
|----------|-----------------------|
| 1 | 55 |
| 2 | 150 |
| 4 | 104 |
| 8 | 63 |
| 14 | 41 |
| 24 | 21 |

Table 9.3 Drug levels following an oral 15mg dose of drug.

Answer is available in the final section of the book.

9.8 Appendix

Derivation of the equation: $\frac{F_1}{F_2} = \frac{AUC_1}{AUC_2}$

$AUC = F \cdot D / Cl$ (From Chapter 5)

$$\frac{D}{Cl} = \frac{AUC}{F}$$

We can then write two forms of the equation, with subscripts (1 & 2), to represent the two occasions when the drug was administered ...

$$\frac{D_1}{Cl_1} = \frac{AUC_1}{F_1} \qquad \frac{D_2}{Cl_2} = \frac{AUC_2}{F_2}$$

However, we arrange for such trials to use the same dose on both occasions, so $D_1 = D_2$; furthermore the same subject is used on both occasions and we will make the (reasonable) assumption that clearance will not change markedly over a fairly short time period, so $Cl_1 = Cl_2$. Thus, the terms D_1 / Cl_1 and D_2 / Cl_2 are equal. Combining the two equations together, we can therefore say that:

$$\frac{AUC_1}{F_1} = \frac{AUC_2}{F_2}$$

$$\frac{F_1}{F_2} = \frac{AUC_1}{AUC_2}$$

10 Multiple dosing

This chapter deals with therapy administered as repeated discrete doses. The route of administration may be i.v. or extravascular. This material should be of interest for both drug development and the clinical application of pharmacokinetics.

10.1 Pharmacokinetic accumulation and steady state

Figure 10.1 shows two patterns that may emerge during multiple dosing.

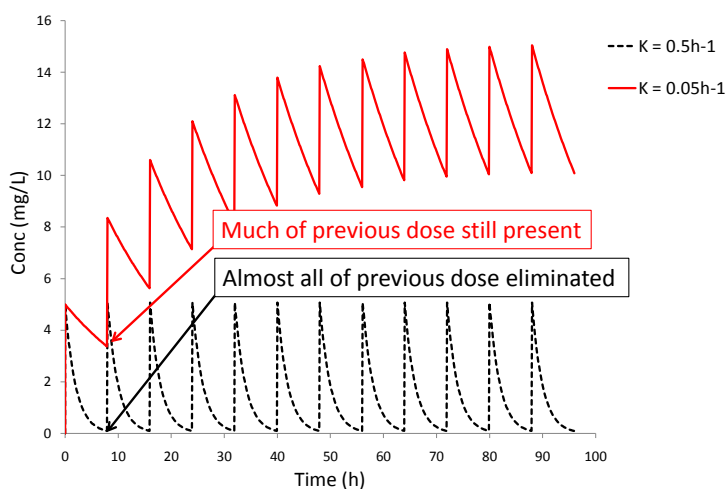

Figure 10.1 Multiple dosing (three times daily) with and without accumulation

In the lower trace (dotted line), the drug is eliminated rapidly ($K = 0.5\text{h}^{-1}$) and by the time the next dose is due, virtually the whole of the initial dose has been eliminated. Thus the second dose simply repeats the pattern seen with the first.

In the upper trace (solid line), drug elimination is much slower ($K = 0.05\text{h}^{-1}$) and only a fraction of the initial dose has been eliminated by eight hours. So the next dose is additional to a large residue still present in the body and the second peak is much higher than the first. The third is higher still and so on. This is referred to as pharmacokinetic accumulation.



Pharmacokinetic accumulation will occur if a significant proportion of one dose is still present at the time when the next dose is due.

The first pattern requires no special considerations or formulae beyond what has already been established, as it can be treated simply as a series of single injections. It is therefore the accumulating pattern that is of primary interest in this chapter.

Figure 10.2 explains why accumulation does not continue indefinitely. Each of the time intervals marked by the striped pattern is a ‘Dosage interval’ – i.e. the time between one dose and the next. We will consider the amount of drug entering and leaving the body in each of the three marked intervals.

The amount entering the body is fixed – one dose (D) in the case of i.v. administration or in the case of extravascular administration, taking account of bioavailability, it is $F \times D$.

The amount eliminated in an interval depends upon the body load. At an early stage (A), body load is still low, so the amount eliminated within the dose interval is much less (\ll) than the dose that enters and there is rapid accumulation. By the second marked interval (B), body load and amount eliminated are higher, but elimination still does not quite match the dose entering, and there is continuing accumulation. By the late interval (C), body load is high enough to drive up the rate of elimination to match the incoming dose and there is no further accumulation.

The late period is referred to as ‘Steady state.’ With infusion, this term described a period when blood levels were completely constant. In this situation, blood levels fluctuate as the individual doses are given, but it is considered ‘Steady state’ because there is no further net accumulation.

Please click the advert

See the light!
The sooner you realize we are right,
the sooner your life will get better!

A bit over the top? Yes we know!
We are just that sure that we can make your
media activities more effective.



Get “Bookboon’s Free Media Advice”
Email kbm@bookboon.com



bp CREDIT SUISSE DAIMLER Unilever Microsoft bookboon.com

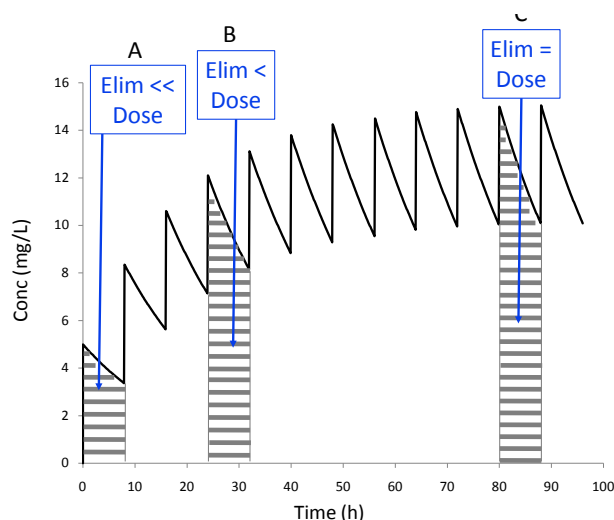

Figure 10.2 The approach to steady state during multiple dosing

10.2 Multiple extravascular doses

In Figures 10.1 and 10.2 the doses were i.v. – see the immediate, sharp peaks, however the same general principle of accumulation applies to oral and other extravascular doses. Figure 10.3 shows accumulation with extravascular dosing. Because the absorption process takes some time, the peaks are delayed and rounded.

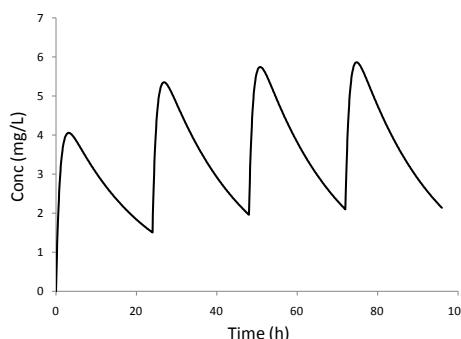

Figure 10.3 Delayed, rounded peaks with multiple, extravascular (e.g. oral) doses

10.3 Concentrations at steady state

Figure 10.4 shows the commonly reported concentrations at steady state. The terms ‘Peak’ and ‘Trough’ are frequently used to describe the highest and lowest concentrations at steady state, but this book will use the synonymous terms ‘ $C_{ss,max}$ ’ and ‘ $C_{ss,min}$ ’. It is also common practice to indicate the average concentration at steady state (‘ $C_{ss,av}$ ’). ‘ \bar{C}_{ss} ’ is used as an alternative symbol for the average concentration; it is pronounced ‘C bar SS’.

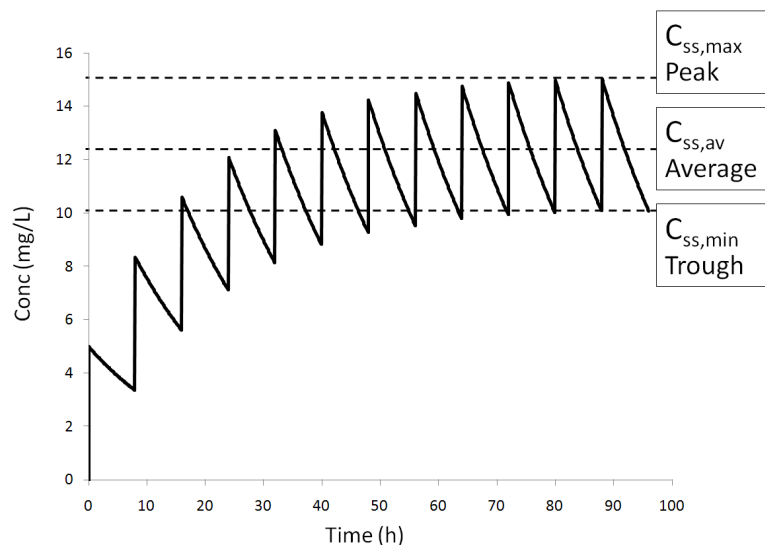

Figure 10.4 Average, Maximum and Minimum concentrations at steady state

10.3.1. Average concentration at steady state - $C_{ss,av}$

For many drugs, a satisfactory clinical outcome can be achieved if we simply ensure that the average concentration at steady state ($C_{ss,av}$) is within some given range. The concentration will then fluctuate above and below this value, but so long as this fluctuation is not excessive, all will be well. The formula for calculating $C_{ss,av}$ is shown below (See appendix to this Chapter for derivation):

$$C_{ss,av} = \frac{F \cdot D}{Cl \cdot \tau}$$

F , D and Cl should be familiar – Bioavailability, Dose and Clearance. τ is a new symbol representing the dosage interval. So (for example) if doses are given twice daily, $\tau = 12$ hours.

This equation is very general; it can be applied under almost all circumstances. It doesn't matter whether a drug occupies one or two compartments. It can also be applied to both i.v. and extravascular dosing, as F is built into the equation to account for any incomplete bioavailability.

| | |
|---|--|
|  | <p>The equation used to calculate $C_{ss,av}$ is completely general. It can be applied to i.v. or extravascular doses administered into one or two compartment systems.</p> |
|---|--|

We can calculate $C_{ss,av}$ for the case modelled in Figure 10.4. Dosing is 50mg of drug administered i.v., three times daily and the drug has a clearance of 0.51 L/h. With i.v. dosing, bioavailability will automatically be 1.0:

$$C_{ss,av} = \frac{F \cdot D}{Cl \cdot \tau}$$

$$= \frac{1.0 \times 50\text{mg}}{0.51\text{L/h} \times 8\text{h}}$$

$$= 12.25 \text{ mg/L}$$

In clinical practice, we are likely to want to calculate an appropriate dose in order to achieve a given target value. The example below shows the calculation for the following conditions:

- The target average concentration at steady state = 1.5mg/L
- Clearance is 1.6L/h
- Drug is to be administered orally, twice daily
- Oral bioavailability is 90%
- Drug is to be administered as a salt containing 75% of the parent drug

$$C_{ss,av} = \frac{F \cdot S \cdot D}{Cl \cdot \tau}$$

(Note S added to the top of the equation, to reduce the calculated $C_{ss,av}$)

$$D = \frac{C_{ss,av} \times Cl \times \tau}{F \times S}$$

Trust and responsibility

NNE and Pharmaplan have joined forces to create NNE Pharmaplan, the world’s leading engineering and consultancy company focused entirely on the pharma and biotech industries.

Inés Aréizaga Esteva (Spain), 25 years old
Education: Chemical Engineer

– You have to be proactive and open-minded as a newcomer and make it clear to your colleagues what you are able to cope. The pharmaceutical field is new to me. But busy as they are, most of my colleagues find the time to teach me, and they also trust me. Even though it was a bit hard at first, I can feel over time that I am beginning to be taken seriously and that my contribution is appreciated.

Please click the advert



NNE Pharmaplan is the world’s leading engineering and consultancy company focused entirely on the pharma and biotech industries. We employ more than 1500 people worldwide and offer global reach and local knowledge along with our all-encompassing list of services.
nnepharmaplan.com

nne pharmaplan®

$$= \frac{1.5\text{mg/L} \times 1.6\text{L/h} \times 12\text{h}}{0.9 \times 0.75}$$

$$= 42.7 \text{ mg of the salt orally, twice daily.}$$

10.3.2 Peak and trough concentrations.

For some drugs, we cannot simply adjust the average drug concentration. For these we do need to be cognisant of the peaks and troughs ($C_{ss,max}$ and $C_{ss,min}$). The equation for peak concentrations during multiple dosing is the ugliest we will have to deal with – but unfortunately it is vital for clinical practice. (See Appendix to this chapter for derivation of this and the next equation).

$$C_{ss,max} = D/V \times 1/(1 - e^{-k\tau})$$

Like most pharmacokinetic equations, it is actually much easier to use than it might appear, provided that we proceed one stage at a time and always be careful in the use of units.

Once we have calculated the peak concentrations, the troughs are much easier:

$$C_{ss,min} = C_{ss,max} - D/V$$

These equations are much less general than that for $C_{ss,av}$. They only apply when the drug occupies one compartment and administration is i.v. It might seem that these conditions are so onerous that the equations are hardly worth having. However, the classic case where they are needed in clinical practice is with the use of aminoglycoside antibiotics such as gentamicin. These molecules are so polar that they are virtually unavailable from the oral route and need to be given by injection and they behave approximately as if they occupy one compartment (not exactly, but near enough). So, fortunately in the one area where we are likely to need these equations, they are appropriate.



The equations used to calculate $C_{ss,max}$ and $C_{ss,min}$ have very restricted applicability, but fortunately are applicable to aminoglycoside dosing.

With the aminoglycosides we generally want the peak concentrations to fall into a specified range that is high enough to achieve the antibiotic effect and also want the troughs to fall below some target value in order to avoid excessive toxicity. In the following example we will calculate peak and trough concentrations to see if a proposed regime will produce a satisfactory pattern of blood concentrations.

- Proposed dose size = 80mg
- Dosing = three times daily i.v. bolus
- Anticipated volume of distribution = 20 L
- Anticipated elimination rate constant = 0.03 h^{-1}
- Acceptable peak concentrations = 5 to 10mg/L (Note: Target value will vary according to the severity of the infection)
- Acceptable trough concentrations = Less than 2mg/L (Note: Some practitioners may prefer a lower value than this)

$$\begin{aligned}
 C_{ss,max} &= D/V \times 1/(1 - e^{-K\tau}) \\
 &= 80\text{mg}/20\text{L} \times 1/(1 - e^{-0.03\text{h}^{-1} \times 8\text{h}}) \\
 &= 4\text{mg}/\text{L} \times 1/(1 - e^{-0.24}) \text{ Note: No units in exponential as } \text{h}^{-1} \text{ and } \text{h} \text{ cancel out)} \\
 &= 4\text{mg}/\text{L} \times 1/(1 - 0.787) \\
 &= 4\text{mg}/\text{L} \times 1/0.213 \\
 &= 4\text{mg}/\text{L} \times 4.69 \\
 &= 18.76\text{mg}/\text{L}
 \end{aligned}$$

$$\begin{aligned}
 C_{ss,min} &= C_{ss,max} - D/V \\
 &= 18.76\text{mg}/\text{L} - 80\text{mg}/20\text{L} \\
 &= 18.76\text{mg}/\text{L} - 4\text{mg}/\text{L} \\
 &= 14.76\text{mg}/\text{L}
 \end{aligned}$$

The proposed dosage regime (80mg three times daily) would be unexceptional in a patient with normal renal function, but this patient evidently has very poor kidney function (K only 0.03h^{-1}) and consequently the regime would be grossly excessive in this case; peak and trough concentrations both exceeded their target values.

10.3.3 Aminoglycoside use with poor renal function

Aminoglycoside administration in patients with very poor renal function raises a special problem; we want the peaks to be high enough to produce an adequate antibiotic effect, but we also wish to see troughs low enough to avoid toxicity. With poor renal function, we cannot meet both of these goals simply by adjusting the dose size. The solution is to extend the dosage interval. The extra time between doses will allow us to have high peak concentrations, but there will still be adequate time for concentration to fall to a suitably low trough.



For a patient with very poor renal function, aminoglycosides must be administered with long dosage intervals, in order to allow enough time for high peak concentrations to decline to a suitably low trough.

It is useful to consider how many half-lives need to separate the doses and what the half-life of the drug will be in the relevant patient. Take, as an example, the patient described at the end of Section 10.3.2.

$$\begin{aligned}
 K &= 0.03\text{h}^{-1} \\
 t_{\text{half}} &= 0.693 / 0.03^{-1} \\
 &= 23.1 \text{ hours}
 \end{aligned}$$

Target peak concentration was 5 to 10 mg/L, so make the target = 8 mg/L

Target trough was less than 2 mg/L.

So, we need to have concentrations fall four-fold from peak to trough, which means leaving two half-lives between doses. A dosage interval of $2 \times 23.1\text{h}$ is therefore indicated. Taking a figure that is clinically realistic, 48 hours should be adequate. (Previously we were trying to use an interval of 8 hours – no wonder it didn't work!)

Now we know that the interval should be 48 hours, all we have to fix is the dosage size. A spreadsheet is provided that makes it easy to try different dose sizes – See box below:

| | |
|---|--|
|  | <p>An Excel spreadsheet is available to automate the calculation of drug concentrations with multiple i.v. doses. Go to www.phrData.co.uk, click on 'Pharmacokinetics' and then 'Model multiple i.v. injections'.</p> |
|---|--|

Using the spreadsheet, mentioned above, you should find that doses of 110mg every 48 hours allow us to achieve peaks of 5 to 10 mg/l and troughs below 2 mg/L.

10.4 Loading dose

We saw in Chapter 8 that with an infusion alone, accumulation may be too slow and loading doses have to be used to speed up the achievement of adequate drug concentrations. The same may apply with multiple dosing. Figure 10.5 contrasts the concentration versus time profile of a drug with and without a loading dose. The shaded area represents the acceptable concentration range.

Please click the advert



THE MILKWAY
 LAUNCHING GRADUATE CAREERS



MILKROUND SYSTEM
 Become a business star with internships, placements, graduate jobs & schemes from leading companies.
www.milkround.com



PLANET CAREER ADVICE
 Inhabited by insights into business careers and orbited by application advice.



FIRST CONTACT
 Get matched to top business employers via intelligent emails landing in your inbox.

Milkround.com: rated the #1 graduate recruitment website in the UK Graduate Careers Survey 2009 of 16,000 university finalists.

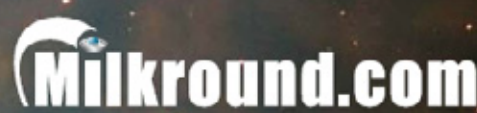

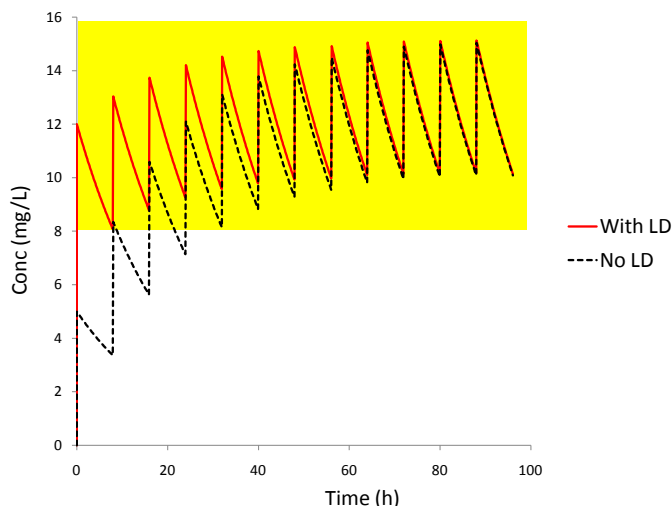

Figure 10.5 Multiple dosing with and without a loading dose

Then formula for calculating a loading dose was presented in Section 8.4; it was:

$$LD = \frac{\text{Target} \times V}{F}$$

The loading dose consists of an initial dose that is greater than the regular maintenance doses. If the loading dose is very large compared to the regular dose, it might be excessive and it will be necessary to achieve loading by more moderately increasing the size of the first two or three doses, rather than giving a single giant dose.

10.5 Accumulation stage

Chapter 8 introduced the rather strange rule that during the accumulation phase of an infusion, blood levels of drug reached 50% of C_{ss} after a period of time equivalent to one elimination half-life of the drug and three quarters of C_{ss} at two half-lives and so on. A similar relationship holds with multiple dosing. Figure 10.6 shows an example where the elimination half-life of the drug is 12 hours, administration is three times daily and the $C_{ss,av}$ is 12.2 mg/L. The vertical red lines mark the time points (12, 24, 36 & 48h) that are equivalent to 1, 2, 3 and 4 times the half-life of the drug. Although the pattern is partially obscured by fluctuation, it can be seen that the general trend of the graph is that we do essentially achieve 50, 75, 87.5 and 93.8% of $C_{ss,av}$ at these times.

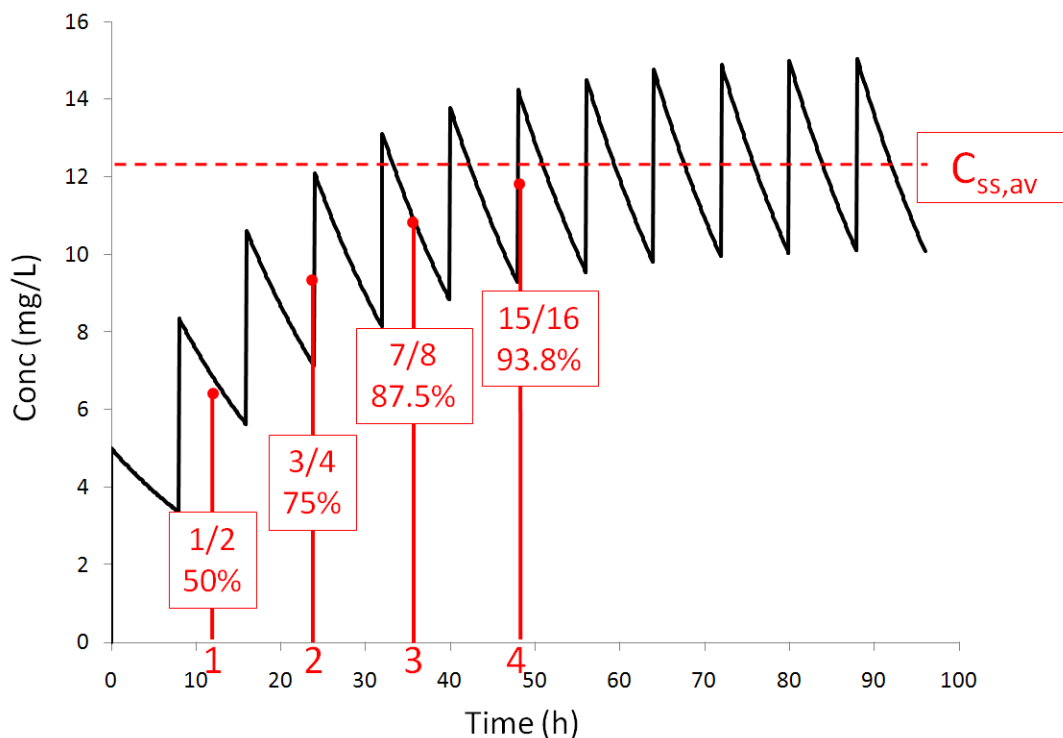

Figure 10.6 The accumulation phase during multiple dosing

It takes a period of time equivalent to three or four elimination half-lives of the drug to achieve steady state (or thereabouts). This is an important result to bear in mind in drug development. If a drug has a long elimination half-life, it will accumulate slowly and clinicians are more likely to have to use loading doses to achieve a therapeutic effect within a reasonable time-frame. Doctors' lives would be much easier if they used a competing drug with a shorter half-life and consequently more rapid accumulation and no need for a loading dose. Drug companies will therefore generally avoid very long half-life molecules wherever possible.



It takes a period of time equivalent to three or four elimination half-lives of the relevant drug to achieve steady state.

10.6 Extent of fluctuation in drug concentrations

If we give discrete doses of drugs, there will inevitably be a fluctuating pattern of drug concentrations with a peak after each dose and a decline to a trough prior to the next dose. We will look at three factors that influence the extent of fluctuation: half-life, dose division and dosage form.

10.6.1 Half-life

A major factor that governs the extent of fluctuation is the drug’s half-life. A short half-life drug is always going to produce a more fluctuating pattern than one that is eliminated slowly. As will be explained shortly, fluctuation can be suppressed by various means, but a very short half-life will always risk bringing complications. It was pointed out in Section 10.5 that very long half-lives can be problematic by making accumulation occur over an extended period; now we can add that very short half-lives are also a problem. Hence, drug companies are looking for the Goldilocks half-life, not too long and not too short.



Drug companies would prefer to avoid drugs with either a long half-life (concentrations take too long to accumulate) or a short half-life (concentrations fluctuate wildly). They like it to be just right!

If a particular drug is likely to suffer excessive fluctuations in concentration, there are two ways to moderate this – dose division and slow release formulations. These are discussed in the next two sections.

10.6.2 Dose division

In Figure 10.7, the overall rate of drug administration is 200mg per day. However, it is modelled as being administered as a single dose (200mg every 24h) or in divided doses of 100mg 12 hourly or 50 mg 6 hourly. The shaded area represents the desirable concentration range.

Please click the advert

“ Top legal people rate The Open University ”

...and some of them are pretty good judges

Raise the bar with top legal courses

Developed in partnership with
The College of Law

The College of Law of England and Wales

Boost your legal career

▶ Find out more

INSPIRING LEARNING

The Open University

Download free ebooks at bookboon.com

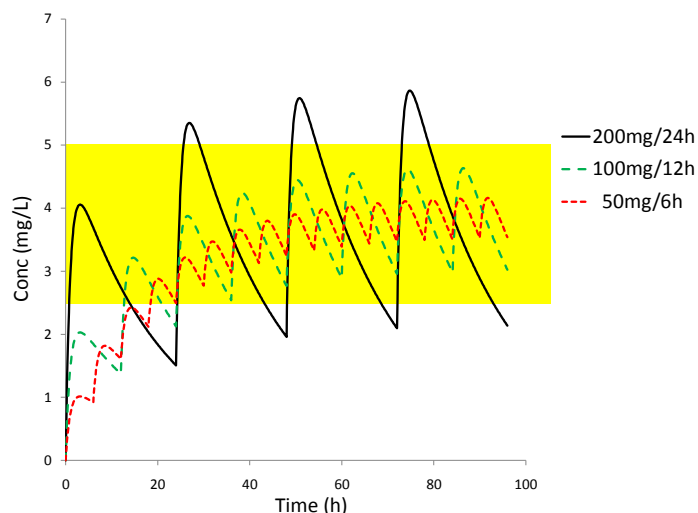

Figure 10.7 The effect of dose division on fluctuation in drug concentration

In the most fluctuating trace (unbroken line), large doses (200mg) are being given and so we see a prominent peak after each dose, but then we have to wait a long time (24h) for the next dose and over this extended period, concentrations fall a long way. This is then followed by another large peak and extended decline etc. Hence the very fluctuating pattern.

In the central trace (short dashes), the individual doses are more modest (50mg) causing only small peaks and the dosage intervals are short (6h) allowing limited time for concentrations to fall between doses. Thus we see a much smoother pattern.

Extreme dose division gives a superior pattern of concentrations that stay comfortably within the desirable range, in contrast to single daily doses where levels oscillate between toxicity and ineffectiveness. However, it is well established that a reasonable proportion of patients will reliably take one dose per day and some can take two, but relatively few will comply with four times daily dosing. We would only adopt this extreme regime if absolutely forced to. In this case, we have a useful compromise – twice daily dosing with 100mg (long dashes) – which is more likely to be complied with and still gives a pattern of concentrations that stays acceptably within the desired range. The general rule is to use the minimum degree of dose division that is consistent with a satisfactory pattern of drug concentrations.

10.6.3 Slow release dosage forms

It was mentioned in Section 9.3 that slow release preparations used in single doses give sustained, moderate concentrations of drug without high peaks or low troughs. Not surprisingly, the same pattern arises with multiple dosing. Figure 10.8 contrasts fast and slow release preparations. The two traces refer to the same dose of the same drug, only the dosage form has been changed. The shaded area is the desirable concentration range.

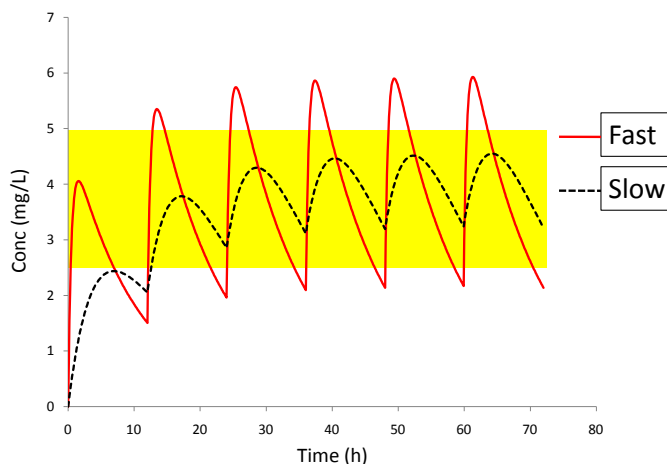

Figure 10.8 Fast and slow release dosage forms of the same dose of the same drug

With the fast release form, we get the same high, early peak as with single dosing and then once absorption has been largely completed there follows a fairly long period of elimination allowing a large drop in concentrations. The slow release form gives peaks that are later and lower, and there is now a shorter period of decline, so we do not see the low troughs we got with the other preparation. Slow release preparations can very effectively reduce fluctuations in concentration (They aren't just a marketing gimmick!).

10.6.4 Practical steps to restrict fluctuation

For any given drug there is little we can do about its half-life, but dose division and dosage form are within our control. If a drug has a rather short half life and we need to control concentration fluctuations we could achieve this in two different ways. The two traces in Figure 10.9 model the same total daily dose of drug, but in one case (solid line) we have suppressed fluctuation by giving the drug four times daily and in the other (dotted line) we have used a slow release form and only needed to give the drug twice per day.

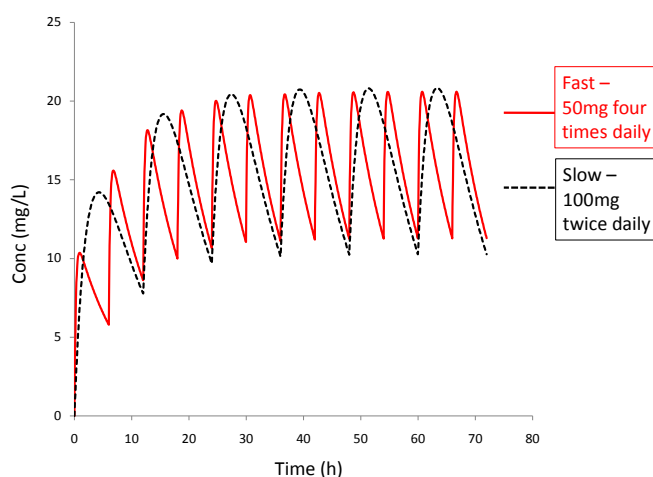

Figure 10.9 Control of fluctuation in concentrations by either extreme dose division (solid line) or by using a slow release formulation (dotted line) in place of one with fast release.

The two methods achieve a very similar envelope of concentrations, but from the patient's point of view, twice daily dosing is easier to comply with. This is why drugs such as theophylline are made available in slow release formulations.



We can suppress fluctuations in concentration either by increasing dose division or by using a slow release dosage formulation. The latter is more convenient for patients.

10.7 Practice questions

1. A patient has an estimated clearance for a drug of 45 mL/min. The drug is to be administered orally, twice daily in doses of 100 mg. The drug has an oral bioavailability of 85%. Calculate the average concentration at steady state that will arise.
2. A drug has a desirable range for average concentration at steady state of 4 – 10 mg/L. It is to be administered as tablets orally, twice daily. It has an estimated volume of distribution and elimination rate constant of 95 litres and 0.035h^{-1} respectively. The drug is 100% orally bioavailable. Calculate an appropriate regular dose size and loading dose.
3. The target for average concentration at steady state for a drug is 50 microgram/L. It is to be administered (once daily) orally as a salt which contains 80% by weight of the parent drug and, in this form, the drug's oral bioavailability is 70%. The drug has a population mean clearance of 11 mL/h/Kg. Calculate an appropriate regular dose size for a patient weighing 50 Kg.
4. A drug is to be administered by repeated bolus i.v. injections three times daily. Dose size is 120 mg. The drug's estimated volume of distribution and elimination rate constant are 45 litres and 0.12h^{-1} respectively. Calculate the drug's maximum and minimum concentrations at steady state. (In this question and next, assume the drug occupies one compartment)

Please click the advert



Sharp Minds - Bright Ideas!

Employees at FOSS Analytical A/S are living proof of the company value - First - using new inventions to make dedicated solutions for our customers. With sharp minds and cross functional teamwork, we constantly strive to develop new unique products - Would you like to join our team?

FOSS works diligently with innovation and development as basis for its growth. It is reflected in the fact that more than 200 of the 1200 employees in FOSS work with Research & Development in Scandinavia and USA. Engineers at FOSS work in production, development and marketing, within a wide range of different fields, i.e. Chemistry, Electronics, Mechanics, Software, Optics, Microbiology, Chemometrics.

We offer
A challenging job in an international and innovative company that is leading in its field. You will get the opportunity to work with the most advanced technology together with highly skilled colleagues.

Read more about FOSS at www.foss.dk - or go directly to our student site www.foss.dk/sharpminds where you can learn more about your possibilities of working together with us on projects, your thesis etc.

The Family owned FOSS group is the world leader as supplier of dedicated, high-tech analytical solutions which measure and control the quality and production of agricultural, food, pharmaceutical and chemical products. Main activities are initiated from Denmark, Sweden and USA with headquarters domiciled in Hillerød, DK. The products are marketed globally by 23 sales companies and an extensive net of distributors. In line with the corevalue to be 'First', the company intends to expand its market position.

Dedicated Analytical Solutions

FOSS
 Slangerupgade 69
 3400 Hillerød
 Tel. +45 70103370
www.foss.dk



Download free ebooks at bookboon.com

5. A drug is to be administered by repeated bolus i.v. injections twice daily (Dose size = 20mg). The population average volume of distribution and clearance for the drug are 0.71L/Kg and 1.5mL/min/Kg respectively. The patient weighs 65Kg. Calculate $C_{ss,max}$ and $C_{ss,min}$ with this regimen.
6. Use the spreadsheet 'Model multiple i.v. injections' provided under 'Pharmacokinetics' in www.phrData.co.uk to design a dosing schedule that meets the conditions below:
 - Estimated volume of distribution = 20 L
 - Estimated $K = 0.09 \text{ h}^{-1}$
 - Peak concentrations to be 5 to 10 mg/L
 - Trough concentration to be less than 1 mg/L

Answers are available in the final section of the book.

10.8 Appendix

Derivation of equation: $C_{ss,av} = \frac{F \cdot D}{Cl \cdot \tau}$

At steady state, the amount of drug entering the body in one dosage interval is balanced by the amount eliminated in the same period.

Amount entering = $F \cdot D$

| | |
|---|--|
| Amount eliminated = Average rate of elimination $\times \tau$ = Average body load $\times K \times \tau$ = $C_{ss,av} \times V \times K \times \tau$ = $C_{ss,av} \times Cl \times \tau$ | Average rate of elimination = Average body load $\times K$ Average body load = $C_{ss,av} \times V$ $K \times V = K \times V = Cl$ |
|---|--|

Bring together the terms for amounts entering and eliminated ...

$F \cdot D = C_{ss,av} \times Cl \times \tau$ (Re-arrange)

$$C_{ss,av} = \frac{F \cdot D}{Cl \cdot \tau}$$

Derivation of equation: $C_{ss,max} = D/V \times 1/(1 - e^{-K\tau})$

The proofs of the formulae for peak and trough concentrations are based on the fact that concentrations decline from peak to trough in the normal exponential manner and then rise again when a new dose is injected. The key point is that, **at steady state, the exponential decline over the dosage period is exactly balanced by the rise caused by the next dose.**

The exponential decline from the peak over the dosage interval (τ) will result in a trough concentration of:

$$C_{ss,min} = C_{ss,max} \times e^{-k\tau}$$

The extent of the decline from peak to trough is therefore:

$$\begin{aligned} \text{Decline} &= C_{ss,max} - C_{ss,max} \times e^{-k\tau} \\ &= C_{ss,max} \times (1 - e^{-k\tau}) \end{aligned}$$

The rise associated with a new dose (D) of drug is:

$$\text{Rise} = D/V$$

At steady state, the decline and rise are equal in size, so ...

$$\begin{aligned} C_{ss,max} \times (1 - e^{-k\tau}) &= D/V \\ C_{ss,max} &= D/V \times 1 / (1 - e^{-k\tau}) \end{aligned}$$

Derivation of equation: $C_{ss,min} = C_{ss,max} - D/V$

We have already established (above) that the rise in concentration from trough to peak concentration is:

$$\text{Rise} = D/V$$

So, the Peak will be Trough + Rise, hence

$$C_{ss,max} = C_{ss,min} + D/V$$

$$C_{ss,min} = C_{ss,max} - D/V$$

11 Non-linear pharmacokinetics

This chapter describes a situation where many of the assumptions made in previous chapters break down. The problem we are going to consider only arises with drugs that are mainly or entirely eliminated by metabolism. This short chapter is relevant to both drug development and clinical practice.

11.1 Considering drug metabolism as an enzyme catalysed reaction

Drug metabolism by Cytochrome P450 etc is an example of an enzyme catalysed reaction. The enzyme is the cytochrome, the substrate is the drug and the product is the drug metabolite. Consequently, drug metabolism should follow the general rules of enzyme kinetics. Figure 11.1 shows the relationship between the rate of an enzyme catalysed reaction and substrate concentration.

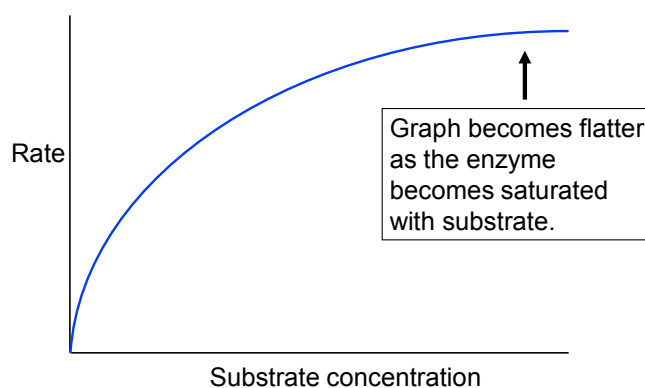

Figure 11.1 Relationship between rate of an enzyme catalysed reaction and substrate concentration

As the amount of available substrate increase, rate of reaction also increases, however we eventually reach a situation where each enzyme molecule is almost permanently involved in processing substrate and the addition of further substrate just adds to the swarm of molecules that are already waiting for a chance to bind to an enzyme. The graph becomes steadily flatter and eventually reaches a limiting maximum velocity.

In principle, the same thing should apply to drug metabolism, so we can re-present the previous general figure relating it to the specific situation of drug metabolism. See Figure 11.2. Instead of referring to rate of reaction and substrate concentration we now have elimination rate and drug concentration.

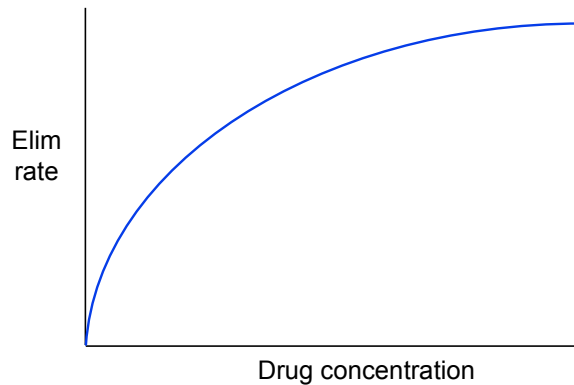

Figure 11.2 Theoretical relationship between the rate of elimination of a drug and the drug's concentration in the patient.

However, the clinical reality is that most drugs are used at blood concentrations that fall far short of achieving any significant degree of saturation of the hepatic metabolic enzymes. Consequently, it is only the area marked off in the bottom left hand corner of Figure 11.3 that is clinically relevant. The rest of the graph relates to what would happen with drug levels that are unrealistically high and probably toxic.

Please click the advert

The Wake

the only emission we want to leave behind

Low-speed Engines Medium-speed Engines Turbochargers Propellers Propulsion Packages PrimeServ

The design of eco-friendly marine power and propulsion solutions is crucial for MAN Diesel & Turbo. Power competencies are offered with the world's largest engine programme – having outputs spanning from 450 to 87,220 kW per engine. Get up front! Find out more at www.mandieselturbo.com

Engineering the Future – since 1758.

MAN Diesel & Turbo



Download free ebooks at bookboon.com

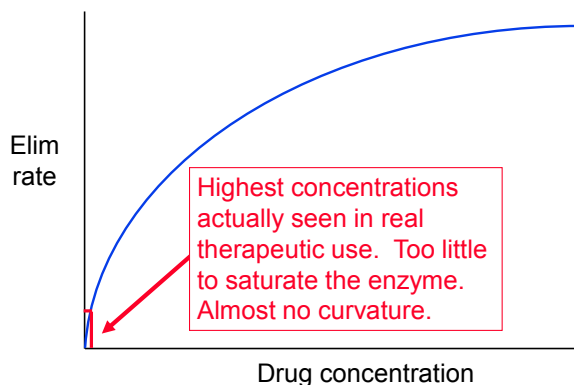

Figure 11.3 Rate of elimination and clinically realistic drug concentrations

As a result, most drugs never achieve any significant degree of saturation of the enzymes and the relationship between rate of elimination and concentration is effectively linear. Hence the term 'Linear pharmacokinetics'. See Figure 11.4.

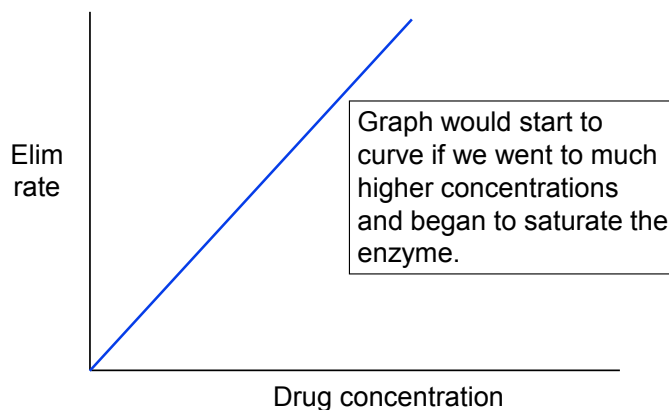

Figure 11.4 Linear relationship between rate of drug elimination and drug concentration.

11.2 Exceptions to linearity

There are a few drugs that do reach concentrations that cause significant enzyme saturation. The best known culprits are:

- Phenytoin
- Salicylates
- Ethanol

Phenytoin provides the one clinically significant case. It is a drug with a narrow therapeutic window and serious toxicity in overdose, so controlling its blood concentrations is a real concern.

Salicylates do cause saturation, but they are not drugs where clinical practitioners are involved in trying to control concentrations within some narrow band. Their non-linear kinetics are largely academic.

Ethanol in doses high enough to cause noticeable effects, will fully saturate the liver enzymes. However, it is not a substance where clinicians are going to be involved in dose calculations (not on a professional basis anyway).

There is evidence of a degree of enzyme saturation with theophylline, however the effect is quite small and for practical, clinical purposes its kinetics are treated as linear.

So, the reality is that the clinical relevance of this chapter lies solely with the use of phenytoin. None-the-less, for that drug, its non-linear nature is very important.

11.3 Effect of non-linearity on the relationship between dose and drug concentration.

Figure 11.5 emphasizes the difference between the majority of drugs (linear) and the exceptions such as phenytoin.

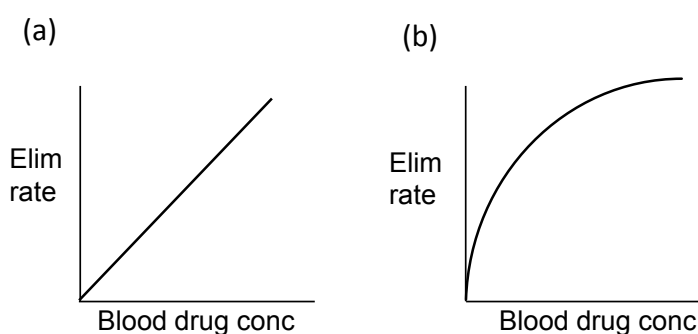

Figure 11.5 (a) Linear kinetics with most drugs and (b) non-linear kinetics with a few drugs such as phenytoin

When a drug is given long-term, we eventually achieve steady state, where the amount of drug administered every day is balanced by daily drug elimination (Chapter 10). Parts (a) and (b) of Figure 11.6 effectively repeat Figure 11.5, but add the idea that what is measured on the vertical axis – rate of elimination – can be equated to rate of drug administration (assuming steady state has been achieved). Parts (c) and (d) simply reverse the axes of parts (a) and (b) – horizontal is swapped with vertical. In these diagrams, the reference to rate of elimination has been dropped and we focus solely on the rate of drug administration.

The relationship shown in part (c) is another reason for the use of the term ‘Linear kinetics’.

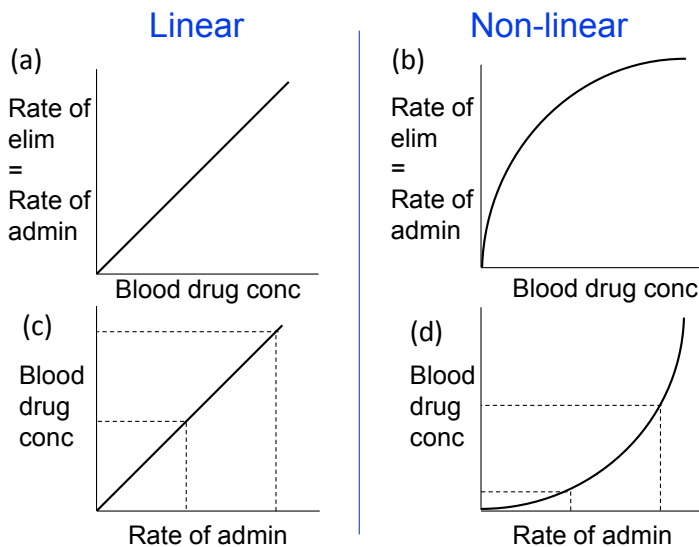

Figure 11.6 The effect of non-linearity upon the relationship between dose and blood concentration at steady state

11.4 Clinical significance of non-linear kinetics

Dotted lines on part (c) of Figure 11.6 indicate two rates of drug administration which differ by a factor of two and the blood drug levels that would be associated with them. Doubling the rate of administration simply doubles the consequent blood levels. For most drugs, there is a very simple rule that an x% change in dose leads to an x% change in blood levels. This makes dosage adjustment very simple – if you want a 25% increase in blood levels, increase the dose by 25%

Please click the advert

THIS **ebook** IS PRODUCED WITH **iText®**

Download free ebooks at bookboon.com

However, this simple relationship certainly does not extend to the likes of phenytoin. From part (d) of Figure 11.6, it is clear that a doubling in dose would achieve far more than a doubling in blood levels.

Given the potential toxicity of phenytoin, dosage adjustment is a specialist job; the normal concepts and rules just don't apply. General pharmacokinetics assumes first order drug elimination where the elimination rate constant is a valid concept. With non-linear kinetics, there is no longer a constant proportionality between rate of elimination and drug concentration (Figure 11.6 part b) and the idea of an elimination rate constant linking the two no longer applies. Because the elimination rate constant is intimately linked to half-life and clearance, these two parameters also cease to apply. The only way to describe drug elimination in the non-linear situation is to go all the way back to the fundamental enzymological constants V_{max} and K_m . Unlike K , these do have fixed values for a particular drug in a particular patient and can be used to calculate what concentration of drug would arise from a given dosage regime.

There are a number of different ways to go about dose adjustment with phenytoin. However, this book is designed to convey general principles and detailed coverage of the art of phenytoin dose adjustment is well beyond its remit.



For most drugs, changes in dose size bring simple, proportionate changes in blood levels. With non-linear drugs such as phenytoin, changes in blood levels are disproportionately large. Great caution is required.

11.5 Non-linear kinetics and drug development

Clinical workers are subjected to considerable additional complexity when trying to use a non-linear drug like phenytoin and given a choice of drugs that are otherwise equally acceptable, they would undoubtedly choose one with simple linear kinetics over a non-linear one. There is therefore a strong commercial disinclination to proceed with the development of any further non-linear drugs; companies would want to establish at an early stage, that any candidate drug did not suffer from this problem.



Drug companies want to establish at an early stage that any new candidate drug molecule obeys simple linear kinetics.

12 Non-compartmental pharmacokinetics

This chapter briefly introduces an alternative method for determining pharmacokinetic parameters such as the elimination rate constant and clearance from experimental data. It achieves the same outcomes that we saw in Chapter 6, but is preferred by some workers as it requires less assumptions. This chapter is relevant to the drug development process; it is very unlikely to have any application in clinical practice.

This account is not intended to provide full coverage of non-compartmental analysis; it should however make you aware of the availability of an alternative methodology.

12.1 The case for non-compartmental methods

In Chapter 3, we saw that drugs may be modelled as occupying one or two compartments. With two compartments, we assume that drugs enter certain tissues at a slow but fixed rate. When faced with real kinetic data, we may actually find that entry into some parts of the body is very slow and that we need to consider using a three-compartment model with tissues being entered (i) instantly, (ii) slowly or (iii) very slowly. To make matters even worse, it is quite common to find that data from some patients can be modelled satisfactorily with a two compartment model while others seem to require three. In a traditional compartmental analysis, we would then have to decide whether to force all the patients' data into a common model or allow different models for individual patients.

Non-compartmental analyses allow us to obtain values for K and Cl etc without committing ourselves to any particular compartmental model.

12.2 Calculation methods

The method of calculation shown below is relevant to a bolus i.v. injection. It would not be applicable for an infusion or an extravascular dose.

12.2.1 First moment of concentration

Non-compartmental analyses require the calculation of the 'First moment of concentration'. The value of the first moment at any point in time ($Moment_t$) is calculated as the concentration at that time (C_t) multiplied by the time (t).

$$Moment_t = C_t \times t$$

Figure 12.1 shows the familiar shape of a concentration curve (solid line) following a single bolus i.v. injection (2mg) and also the first moment (dotted line). The first moment involves multiplying concentration by time and as the graph starts at time zero, the initial value for the moment is also zero. After this, time increases and concentration declines and the value obtained by multiplying them together, rises to a peak and then declines.

The two crucial values that are then used for further calculation are the areas under the two curves. We have already met (Chapter 5) the Area Under the concentration versus time Curve (AUC) and now we also have the Area Under the Moment versus time Curve (AUMC). The areas under the two curves in Figure 12.1 are $AUC = 261.6\text{ng}\cdot\text{h}/\text{mL}$ and $AUMC = 1,855\text{ng}\cdot\text{h}^2/\text{mL}$. The trapezoidal rule which was described in Section 9.6, provides a practical method for determining the areas from real experimental data.

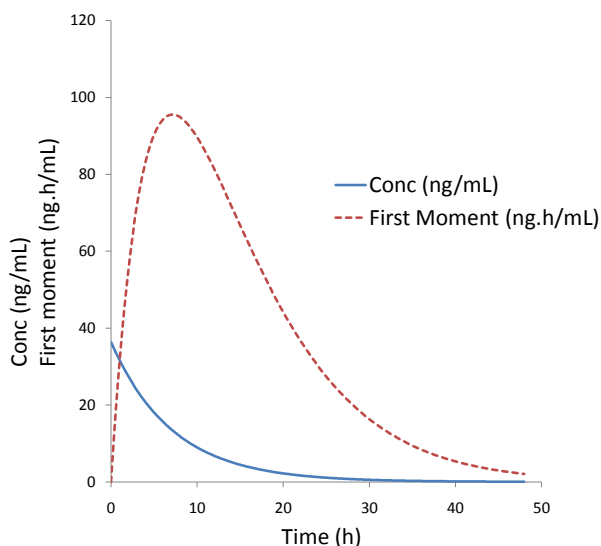

Figure 12.1 Drug concentration and first moment of concentration versus time

Please click the advert

www.job.oticon.dk

oticon
PEOPLE FIRST

12.2.2 Mean Residence Time (MRT)

Non-compartmental analyses make extensive use of a new (but pleasantly intuitive) parameter called the Mean Residence Time (MRT). A dose of drug consists of millions of individual molecules. Some of these will be eliminated fairly soon after injection and others will survive for longer. The Mean Residence Time is simply the average survival time among all these molecules. The MRT can be calculated as:

$$\text{MRT} = \text{AUMC} / \text{AUC}$$

For the case shown in Figure 12.1:

$$\begin{aligned} \text{MRT} &= 1,855 \text{ ng.h}^2/\text{mL} / 261.6 \text{ ng.h/mL} \\ &= 7.09 \text{ hours} \end{aligned}$$

12.2.3 Other parameters

Other kinetic parameters are then calculated using the formulae:

$$\begin{aligned} K &= 1 / \text{MRT} \\ \text{Cl} &= \text{F.D} / \text{AUC} \end{aligned}$$

So, in our case ...

$$\begin{aligned} K &= 1 / 7.09 \text{ h} \\ &= 0.141 \text{ h}^{-1} \\ \text{Cl} &= \text{F.D} / \text{AUC} \\ &= 1.0 \times 2 \text{ mg} / 261.6 \text{ ng.h/mL} \\ &= 2,000,000 \text{ ng} / 261.6 \text{ ng.h/mL} \\ &= 7,645 \text{ mL/h} \\ &= 7.65 \text{ L/h} \end{aligned}$$

Notice that in the above calculation of the elimination rate constant and clearance, no consideration was given as to how many compartments the drug occupied. The whole calculation simply used the areas under the two curves.

12.3 More complex situations

For infusion or extravascular dosing, the above approach is too simple and we need to account for the mean time taken for individual molecules to enter the body. This is called the MAT, commonly interpreted as ‘Mean Absorption Time’, but to allow for its application to an infusion, ‘Mean Arrival Time’ is preferable. Hence it is the average time a molecule has to wait to get into the body, following oral administration of a dose or the start of an infusion.

With the addition of the MAT, non-compartmental analyses can be extended to a wider range of dosing regimens.



Non-compartmental methods allow us to proceed with analyses of experimental data without having to make (often arbitrary) decisions about how many compartments a drug appears to occupy.

13 Computerized analysis of pharmacokinetic data

This chapter will illustrate the basic principles behind computer algorithms for analysing pharmacokinetic data. Results from Section 6.1 which concerned a single bolus i.v. injection into one compartment will be used as an example, but data from other scenarios can be analyzed using the same basic principles.

The material presented here is of possible relevance to those interested in drug development; it is not likely to be relevant in clinical practice.

13.1 Least squares fitting

Unlike the process we saw in Section 6.1.2, computer methods do not attempt to linearize the data by logarithmic transformation. Instead a curve is fitted directly to the untransformed data.



Computerized analyses do not linearize the data using log transformation of the data. A curve is objectively fitted to the points.

In the case of a single i.v. dose administered into one compartment, we need to optimize values for just two parameters – V and K (Clearance can then be calculated from these.). To start the process, we need some initial estimates of these values; these might be derived from a previous graphical analysis as in Section 6.1.2. We then construct a theoretical concentration versus time curve, using our initial estimates of V and K to calculate C_0 and concentrations at later times. Figure 13.1 shows a theoretical curve based on some reasonable (not necessarily ideal) initial estimates of V and K ; the figure also shows the observed data from Table 6.1. The next stage is to adjust the values of V and K so as to improve the fit of the theoretical curve to the observed points. To guide that process, we need an objective criterion by which to judge the goodness-of-fit for a given curve.

The vertical dotted lines in Figure 6.3 show the differences (‘Deviations’) between each observed concentration and the concentration that would be read off the proposed curve at that time. To assess the quality of this model we take each deviation and square it and then add up all these squared deviations. This total is then the ‘Sum of squared deviations’ and is usually referred to simply as the ‘Sum of squares’. This is a measure of how poor the model is; the greater the sum of squares, the worse the fit. The best fitting curve is then the one that generates the lowest value for the sum of squares. The procedure for optimizing the curve is commonly termed ‘Least squares fitting’.



The best fitting curve is the one that minimizes the sum of squared deviations of the observed points from the theoretical curve (Least squares fitting).

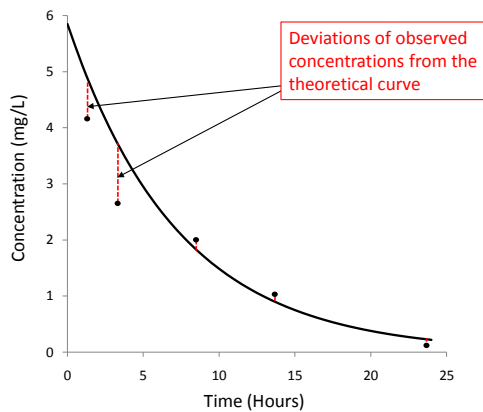

Figure 13.1 Deviations of the observed points from a theoretical curve



An Excel spreadsheet is available to automate the production of optimized estimates of V and K for a single bolus i.v. injection into one compartment. Go to www.phrData.co.uk, click on 'Pharmacokinetics' and then 'Curve fitting'.

The initial state of the sheet mentioned in the box above, is shown in Figure 13.2.

Please click the advert

01001001 01010100

00100000 01010100

01110010 01100001

01101001 01101110

01100101 01100101

Sie sehen hier mehr als Nullen und Einsen?

Wir sehen Ihre Karriere im IT-Trainee-programm. Als spätere Fach- oder Führungskraft.

www.perspektiven.allianz.de



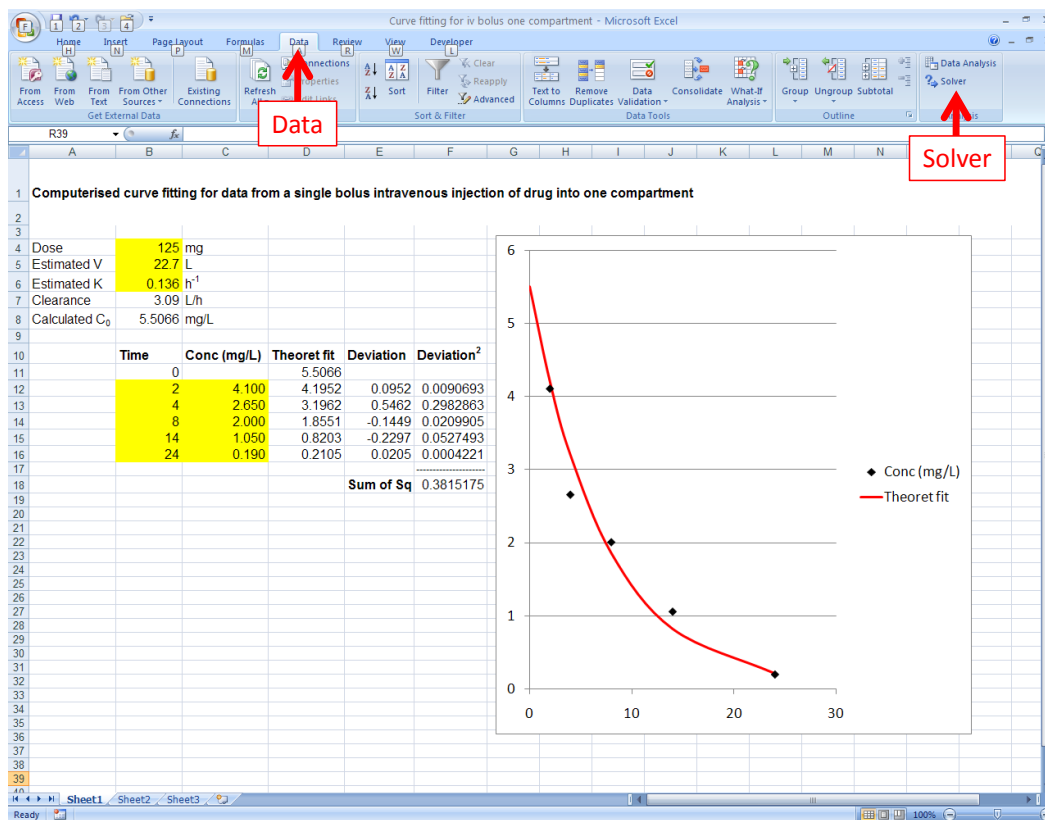

Figure 13.2 Curve-fitting spreadsheet prior to optimization

The layout of the spread-sheet is explained below:

Line 4 records the dose as 125mg.

Curve fitting programmes require starting values for the parameters that are to be estimated, i.e. V and K in this case. The programme then repeatedly runs a routine that modifies these values in order to improve the fit of the curve to the points. On lines 5 and 6, initial values for V and K have been entered. These were taken from the earlier graphical estimates in Section 6.1.2 (22.7 litres and 0.136 h⁻¹ respectively).

Lines 7 and 8 show the calculated clearance and C₀ based on the data above.

Lines 10 to 16 show the following

- The times and observed drug concentrations
- Theoretical drug concentrations at each time point calculated by the usual equation i.e. $C_t = C_0 \cdot e^{-Kt}$ based on the current values of V and K, as given on lines 5 and 6.
- The deviation between each observed and theoretical concentration.
- Each deviation squared

Line 18 gives the sum of the squared deviations.

A graph is included and it shows that the initial estimates of V and K produce a graph that fits the observed data quite well, but Excel may be able to improve on this.

We then use Excel's Solver tool to adjust the values of V and K, so as to minimize the sum of squares. To do this, click on Data and then Solver (Indicated by arrows in Figure 13.2). A Solver window will appear, as in Figure 13.3.

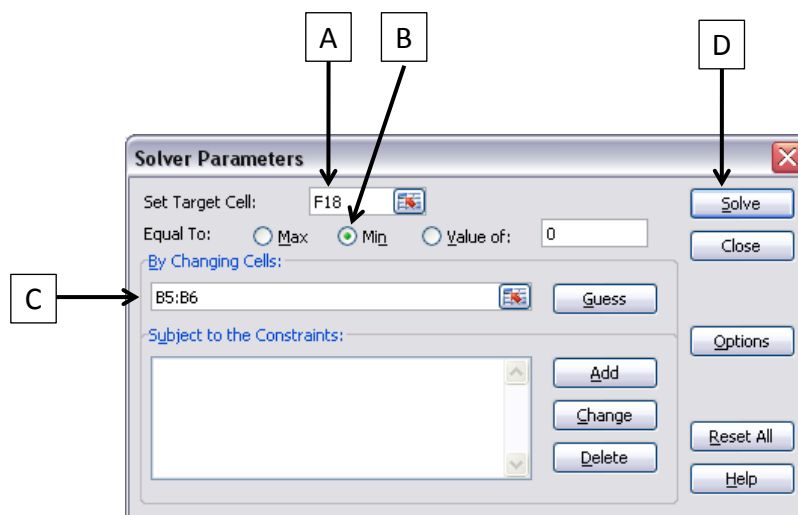

Figure 13.3 The Solver window set up to optimize the fit of the curve to the data

The window is completed as follows:

- The box labelled 'Set Target Cell:' (A) is set to F18 as this is the cell that contains the Sum of Squares, which is the value we want to target for minimization.
- The radio button for Min (B) is selected, because we want to minimize the sum of squares
- The 'By Changing Cells:' box (C) is set to B5:B6 because these two cells contain the values of V and K that we want to modify to get the best fit of the curve to the points.

The 'Solve' button (D) can then be clicked. Once Solver has converged on the optimum solution, OK can be clicked to keep the altered estimates of V and K. Figure 13.4 shows the outcome. The points to note are:

- The estimate of V has been increased somewhat (From 22.7L to 25.3L).
- There has been a small decrease in the estimate of K (0.136 to 0.121h^{-1})
- Estimated clearance is almost unchanged (3.09 to 3.06L/h)
- The sum of squares has declined from 0.382 to 0.247 , indicating that Excel has improved upon the fit-by-eye approach used previously in the graphical method.
- The graph has not changed radically from Figure 13.2, but the fit of the curve to the points does look slightly better.

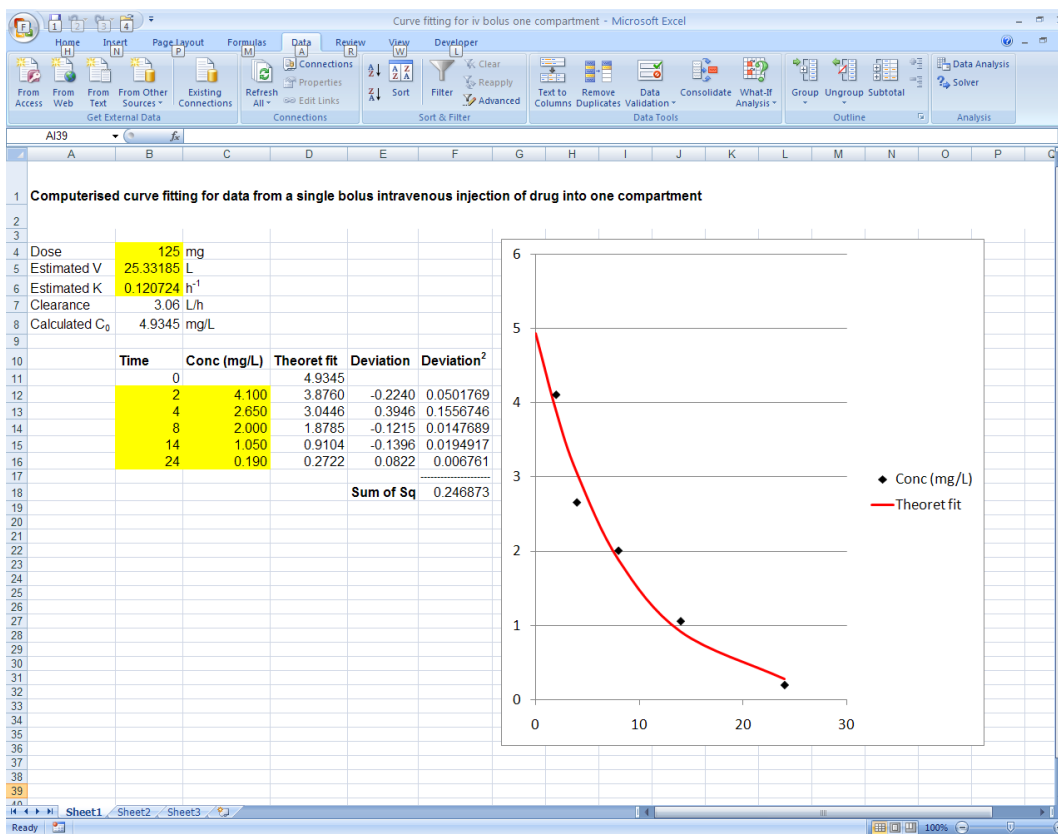

Figure 13.4 Curve-fitting spreadsheet after optimization

Please click the advert

Turning a challenge into a learning curve.
Just another day at the office for a high performer.

Accenture Boot Camp – your toughest test yet

Choose Accenture for a career where the variety of opportunities and challenges allows you to make a difference every day. A place where you can develop your potential and grow professionally, working alongside talented colleagues. The only place where you can learn from our unrivalled experience, while helping our global clients achieve high performance. If this is your idea of a typical working day, then Accenture is the place to be.

It all starts at Boot Camp. It's 48 hours that will stimulate your mind and enhance your career prospects. You'll spend time with other students, top Accenture Consultants and special guests. An inspirational two days

packed with intellectual challenges and activities designed to let you discover what it really means to be a high performer in business. We can't tell you everything about Boot Camp, but expect a fast-paced, exhilarating

and intense learning experience. It could be your toughest test yet, which is exactly what will make it your biggest opportunity.

Find out more and apply online.

Visit accenture.com/bootcamp

- Consulting • Technology • Outsourcing



13.2 Practice question

1. The Practice calculations section of Chapter 6 presented the following data set for analysis by graphical means:

A patient has received a dose of 15mg of a drug by bolus i.v. injection. Blood samples were taken at various times afterwards and analysed for drug concentration. The results are shown in Table 13.12.

| Time (h) | Concentration (ng/mL) |
|----------|-----------------------|
| 4 | 152 |
| 8 | 128 |
| 14 | 74 |
| 20 | 44 |
| 28 | 24 |

Table 13.12 Drug concentrations at various times following 15mg i.v. bolus injection

From www.phrData.co.uk, click on 'Pharmacokinetics' and then 'Curve fitting'. Notice that you can enter new data into the sheet, but you should only change yellow cells – Do not change the contents of any white cells. Enter the dose, blood sampling times and observed concentrations into the appropriate cells. The concentrations have to be in units of mg/L so you will need to convert from ng/mL. Finally, enter whatever values you obtained graphically (Question 1, Chapter 6) for V and K as initial estimates (also yellow cells). Use Solver to optimize the fit. What are the optimized values for V, K & Cl? How do these values compare to those you obtained graphically?

Answers are available in the final section of the book.

14 Creatinine clearance

This chapter introduces the use of serum creatinine concentration as a marker of renal function. It is used to guide dosage calculation for drugs that are extensively excreted via the kidneys. The material in this chapter is mainly relevant to clinical practice rather than drug development.

14.1 Clearance of creatinine and various drugs

We are mainly concerned with those drugs that are simply filtered in the renal glomerulus after which there is no significant re-absorption from, or active secretion into, the urine. Because they are all handled in a similar manner, these drugs have virtually identical renal clearances. Typical examples are the aminoglycoside antibiotics (including gentamicin) which are almost exclusively eliminated in this manner. The renal excretion of digoxin also follows this pattern, although in its case, there is also significant hepatic elimination.

Creatinine is a waste product produced in muscles. Like the drugs mentioned above, it is also excreted by simple filtration in the kidneys and consequently it has the same renal clearance as the relevant drugs. If we can estimate creatinine clearance in a particular patient, then we can reasonably assume that these drugs will have the same renal clearance. Those clearances can then be used in dosage calculations. Digoxin dosing will be used (Section 14.2) to illustrate the use of serum creatinine as a marker of renal function.

14.1.1 Estimation of creatinine clearance

The precise estimation of creatinine clearance is a complex and time consuming process involving 24 hour urine collection and analysis of blood samples and it would be unrealistic to attempt to carry out this procedure for a patient requiring a dosage calculation. However, Cockcroft and Gault (Cockcroft DW & Gault MH (1976) *Nephron* 16: 31–41) have provided a much simpler method to estimate creatinine clearance.

Their method is based on the fact that serum creatinine concentrations will depend upon the rates of production and clearance of this waste product. The logical basis of the method is set out in Figure 14.1.

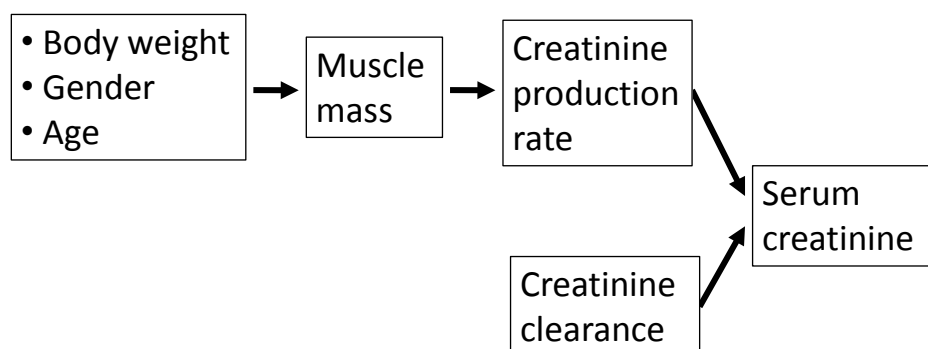

Figure 14.1 Interconnections between body weight, gender, age, creatinine clearance and serum creatinine concentration.

Body weight, gender and age will largely determine muscle mass:

- Body weight – large patients have more muscle than small ones
- Gender – Male patients' bodies generally contain a higher proportion of muscle than those of females
- Age – (Sadly) our bodies tend to lose muscle and gain fat as we age.

Muscle mass then determines the rate of creatinine production as this is where the waste product is produced. Finally, creatinine production rate and creatinine clearance jointly determine serum creatinine concentration. In summary – Serum creatinine should ultimately be related to weight, gender, age and creatinine clearance.

Cockcroft & Gault obtained the following information for a range of individuals:

- Weight
- Gender
- Age
- Serum creatinine (Determined from a blood sample)
- Creatinine clearance (Determined by the classical method)

They then produced empirical equations that related creatinine clearance to the other factors. Their two classic equations are:

$$\text{For men: } CrCl = \frac{1.23 \times (140 - \text{Age}) \times Wt}{SrCr}$$

$$\text{For women: } CrCl = \frac{1.04 \times (140 - \text{Age}) \times Wt}{SrCr}$$

The equations use the following units:

CrCl = Creatinine clearance (mL/min)

Age (Years)

Wt = Weight (Kg)

SrCr = Serum creatinine (µmol/L)

The various numerical values in the two equations were not theoretically determined. Cockcroft & Gault simply determined what values needed to be incorporated into the formulae, so that the calculated creatinine clearance values matched as closely as possible to the observed values in their subjects.

Once the two equations had been established, it was possible to estimate creatinine clearance in new patients, given that we knew their gender, age, weight and serum creatinine concentration. The latter can be determined from a single blood sample; a much quicker and easier procedure than the 24 hour urine collections etc that were formerly necessary.



The Cockcroft and Gault equations allow us to estimate creatinine clearance from serum creatinine. Creatinine clearance then provides a good estimate for the renal clearance of drugs such as aminoglycosides and digoxin.

14.2 Digoxin dosing

In a patient who is free of hepatic or renal disease, digoxin is cleared primarily by the kidneys, but there is additional hepatic metabolism that needs to be taken into account.

- Because of the similar handling of creatinine and digoxin within the kidneys, we assume that the renal clearance of digoxin is equal to that for creatinine.
- We estimate hepatic clearance on a simple body weight basis as 0.33ml/min/Kg. This approach is appropriate for patients of normal build. For a very obese patient, ideal body weight should be substituted for actual body weight.

Total body clearance for digoxin is the sum of renal and hepatic clearance:

$$\text{Digoxin Cl} = \text{Creatinine clearance} + 0.33\text{mL/min/Kg} \times \text{Body weight}$$

As an example, we will consider a patient for whom the intention is to administer digoxin orally, as tablets, once daily. With digoxin, we do not generally need to concern ourselves with the peak and trough levels. It is sufficient to control $C_{ss,av}$ within a suitable range; a target of 0.8 - 2.0 microgram/L being reasonable. We will use the mid-range value as our target concentration i.e. $(0.8 + 2.0) / 2 = 1.4$ microgram/L. The oral bioavailability of digoxin varies according to the pharmaceutical formulation and we will assume a fairly typical figure for tablets of 70%.

The details of the patient we will consider are:

- Gender = Male
- Body weight = 75Kg (Build is normal – no need to use ideal body weight)
- Age = 55 years
- Serum creatinine = 110 $\mu\text{mol/L}$

For men:

$$\begin{aligned} \text{CrCl} &= \frac{1.23 \times (140 - \text{Age}) \times \text{Wt}}{\text{SrCr}} \\ &= \frac{1.23 \times (140 - 55) \times 75}{110} \\ &= 71.3 \text{ mL/min} \end{aligned}$$

Assume digoxin renal clearance also = 71.3 mL/min

$$\begin{aligned} \text{Digoxin hepatic clearance} &= 0.33 \text{ mL/min/Kg} \times 75 \text{ Kg} \\ &= 24.8 \text{ mL/min} \end{aligned}$$

$$\begin{aligned} \text{Digoxin total body clearance} &= 71.3 + 24.8 \text{ mL/min} \\ &= 96.1 \text{ mL/min} \end{aligned}$$

The units of mL/min do not fit well with the rest of the calculation, which will use the dosage interval expressed in units of hours and the target concentration expressed in micrograms/L. It is therefore useful to convert the clearance to units of L/h.

$$\begin{aligned} \text{Cl} &= 96.1 \text{ mL/min} \\ &= 96.1 \times 60 \text{ mL/h} \\ &= 96.1 \times 60 / 1000 \text{ L/h} \\ &= 5.77 \text{ L/h} \end{aligned}$$

Finally, use the estimated clearance to calculate a suitable dosage size:

$$\begin{aligned} \text{C}_{\text{ss,av}} &= \frac{F \cdot D}{\text{Cl} \cdot \tau} \\ D &= \frac{\text{C}_{\text{ss,av}} \times \text{Cl} \times \tau}{F} \\ &= \frac{1.4 \text{ microgram/L} \times 5.77 \text{ L/h} \times 24 \text{ h}}{0.7} \\ &= 277 \text{ microgram} \end{aligned}$$

Remember that digoxin is supplied in tablets that are multiples of 62.5microgram, so nearest realistic dose is $4 \times 62.5 = 250$ microgram.

| | |
|---|---|
|  | <p>Two relevant Excel spreadsheets are available from the pharmacokinetics page of www.phrData.co.uk.</p> <ul style="list-style-type: none"> - 'Creatinine clearance' calculates creatinine clearance using the Cockcroft and Gault equation and - 'Digoxin dosing' calculates digoxin total body clearance and also $C_{ss,av}$ for a given dosing regime. |
|---|---|

14.3 Practice questions

1. Estimate the creatinine clearance (in units of L/h) for a female patient aged 62 who weighs 58Kg and has a serum creatinine of 49 $\mu\text{mol/L}$.
2. Recommend a once daily digoxin dose for a female patient weighing 54Kg and aged 44. She has a serum creatinine of 127 $\mu\text{mol/L}$. Assume she will take tablets with an oral bioavailability of 70% and that the target average concentration at steady state is 1.4 microgram/L.
3. Use the spreadsheets 'Creatinine clearance' and 'Digoxin dosage' from the 'Pharmacokinetics' page of www.phrData.co.uk to check your answers to the previous two questions.

Answers are available in the final section of the book.

Please click the advert



Vestas

Join the Vestas Graduate Programme

Experience the Forces of Wind and kick-start your career

As one of the world leaders in wind power solutions with wind turbine installations in over 65 countries and more than 20,000 employees globally, Vestas looks to accelerate innovation through the development of our employees' skills and talents. Our goal is to reduce CO₂ emissions dramatically and ensure a sustainable world for future generations.

Read more about the Vestas Graduate Programme on vestas.com/jobs.

Application period will open March 1 2012.

Wind. It means the world to us.™

Download free ebooks at bookboon.com

Pharmacokinetic symbols and equations

Symbols

| | |
|---------------|--|
| AUC | Area Under plasma concentration versus time Curve (Zero to infinity time unless stated otherwise.) |
| C_t | Concentration of drug at a stated time (t) after administration |
| C_0 | Concentration of drug at time zero (Initial concentration) |
| C_1 & C_2 | A pair of concentrations observed at times T1 & T2 (See below) |
| C_{ss} | Concentration of drug at steady state during infusion |
| $C_{ss,av}$ | Average concentration at steady state during multiple dosing |
| $C_{ss,max}$ | Maximum concentration at steady state during multiple dosing ('Peak') |
| $C_{ss,min}$ | Minimum concentration at steady state during multiple dosing ('Trough') |
| C_{final} | Concentration in the last of a series of blood samples |
| Cl | Clearance |
| D | Dose |
| F | Fractional bioavailability |
| K | Elimination rate constant |
| K_a | Absorption rate constant |
| LD | Loading dose |
| R_{inf} | Rate of infusion |
| S | Salt factor |
| t | Time elapsed |

| | |
|---------------|--|
| $t_{1/2}$ | Half life |
| T_1 & T_2 | A pair of times at which drug concentrations are observed, following a single bolus i.v. injection |
| Tail | The 'tail' area of an AUC beyond the last observed concentration |
| Target | Target concentration |
| τ | Dosage interval |
| V | Volume of distribution for one compartment drug |
| V1 and V2 | Volumes of distribution for two compartment drug |

| Equation | Comment |
|--|---|
| $V = D/C_0$ | |
| $Cl = K.V$ | |
| $C_t = C_0 \cdot e^{-kt}$ | Only for a single compartment system |
| $K = \frac{0.693}{t_{1/2}}$ | |
| $t_{1/2} = \frac{0.693}{K}$ | |
| $K = \frac{\ln(C_1 / C_2)}{T_2 - T_1}$ | Used in clinical practice where two samples have been taken after a bolus (or at least rapid) injection |
| $C_0 = C_1 / e^{-K.T_1}$ | Same scenario as above |
| $AUC = F.D / Cl$ | |
| $C_{ss} = \frac{R_{inf}}{Cl}$ | |
| $LD = Target.V / F$ | F included to make equation general, but with constant i.v. infusion, F can be ignored (Automatically = 1.0) If salt is used, $LD = Target.V / (F.S)$ |

| | |
|---|---|
| $\frac{F_1}{F_2} = \frac{AUC_1}{AUC_2}$ | |
| Tail = C _{final} / K | |
| $C_{ss,av} = \frac{F \cdot D}{Cl \cdot \tau}$ | |
| $C_{ss,max} = \frac{D}{V} \cdot \frac{1}{(1 - e^{-k\tau})}$ | Only applicable when dose is i.v. and drug occupies one compartment |
| $C_{ss,min} = C_{ss,max} - D/V$ | As above |

Note: Salt factor (S) has not routinely been included in any of the equations above. If a salt is being used, then (D) should be substituted as S.D

Cockcroft and Gault equations

$$\text{For men: } CrCl = \frac{1.23 \times (140 - \text{Age}) \times \text{Wt}}{SrCr}$$

$$\text{For women: } CrCl = \frac{1.04 \times (140 - \text{Age}) \times \text{Wt}}{SrCr}$$

The equations use the following units:

CrCl = Creatinine clearance (mL/min)

Age (Years)

Wt = Weight (Kg)

SrCr = Serum creatinine (μmol/L)

Additional material available from the internet

| | | |
|------------------------|--------------|--|
| TwoPointsAnalysis.xlsx | (Chapter 6) | K and V from two observed concentrations |
| CalculateAUC.xlsx | (Chapter 9) | Trapezoidal rule for AUC |
| MultipleIV.xlsx | (Chapter 10) | Model multiple i.v. injections |
| CurveFitting.xlsx | (Chapter 13) | Curve fitting |
| CockcroftGault.xlsx | (Chapter 14) | Creatinine clearance |
| DigoxinDosing.xlsx | (Chapter 14) | Digoxin clearance and dosage |

Source is www.phrData.co.uk and click on 'Pharmacokinetics'.

Please click the advert





it's an **interesting** world

Get under the skin of it.

Graduate opportunities
Cheltenham | £24,945 + benefits

One of the UK's intelligence services, GCHQ's role is two-fold: to gather and analyse intelligence which helps shape Britain's response to global events, and, to provide technical advice for the protection of Government communication and information systems. In doing so, our specialists – in IT, internet, engineering, languages, information assurance, mathematics and intelligence – get well beneath the surface of global affairs. If you thought the world was an interesting place, you really ought to explore our world of work.

www.careersinbritishintelligence.co.uk

Applicants must be British citizens. GCHQ values diversity and welcomes applicants from all sections of the community. We want our workforce to reflect the diversity of our work.







Answers to practice questions

Chapter 3

1.

Target concentration = midrange value = 200 µg/L

$$\begin{aligned}\text{Predicted } V &= 0.72 \text{ L/Kg} \times 65 \text{ Kg} \\ &= 46.8 \text{ L}\end{aligned}$$

$$\begin{aligned}D &= C \times V \\ &= 200 \mu\text{g/L} \times 46.8 \text{L} \\ &= 9,360 \mu\text{g} \\ &= 9.4 \text{ mg}\end{aligned}$$

2.

$$\begin{aligned}\text{Predicted } V &= 0.91 \text{L/Kg} \times 80 \text{Kg} \\ &= 72.8 \text{L}\end{aligned}$$

$$\begin{aligned}C &= D / V \\ &= 5 \text{mg} / 72.8 \text{L} \\ &= 0.069 \text{ mg/L} && \text{(Remember } 1 \text{mg} = 1000 \mu\text{g)} \\ &= 69 \mu\text{g/L}\end{aligned}$$

Unsatisfactory – the dose is excessive.

3.

$$\begin{aligned}V &= D / C \\ &= 200 \mu\text{g} / 12.5 \text{ng/mL} && \text{(Mixed mass units need to be adjusted)} \\ &= 200 \mu\text{g} / 12.5 \mu\text{g/L} \\ &= 16 \text{L}\end{aligned}$$

4.

$$\begin{aligned}C &= (D \times S) / V && \text{(Note Salt factor is included to reduce the calculated concentration)} \\ &= (5 \text{mg} \times 0.7) / 70 \text{L} \\ &= 3.5 \text{mg} / 70 \text{L} \\ &= 0.05 \text{mg/L} \\ &= 0.05 \mu\text{g/mL} \\ &= 50 \text{ ng/mL}\end{aligned}$$

5.

$$\begin{aligned}
 V &= D / C \\
 &= 0.5\text{mg} / 20\text{ng/mL} && \text{(Mixed mass units to be adjusted)} \\
 &= 500\mu\text{g} / 20\mu\text{g/L} \\
 &= 25\text{L}
 \end{aligned}$$

6.

Target concentration = midrange value = 550ng/mL

$$\begin{aligned}
 \text{Predicted } V &= 0.45\text{L/Kg} \times 70\text{Kg} \\
 &= 31.5\text{L}
 \end{aligned}$$

$$\begin{aligned}
 D &= C \times V \\
 &= 550\text{ng/mL} \times 31.5\text{L} && \text{(Mixed volume units to be adjusted)} \\
 &= 550\mu\text{g/L} \times 31.5\text{L} \\
 &= 17,325\mu\text{g}
 \end{aligned}$$

(Increasing the dose to allow for the salt factor ...)

$$\begin{aligned}
 \text{Dose} &= 17,325\mu\text{g} / 0.75 \\
 &= 23,100\mu\text{g} \\
 &= 23.1\text{mg}
 \end{aligned}$$

Chapter 4

1.

$$\begin{aligned}
 T_{\text{half}} &= 0.693 / K \\
 &= 0.693 / 0.0131\text{h}^{-1} \\
 &= 52.9 \text{ hours}
 \end{aligned}$$

2.

$$\begin{aligned}
 Cl &= Q_H \times E \\
 &= 1.2 \text{ L/min} \times 0.04 \\
 &= 0.048 \text{ L/min} \\
 &= 0.048 \times 60 \text{ L/h} \\
 &= 2.88 \text{ L/h}
 \end{aligned}$$

3.

$$\begin{aligned}
 K &= 0.693 / 12\text{h} \\
 &= 0.058 \text{ h}^{-1}
 \end{aligned}$$

4.

$$\begin{aligned}
 Cl &= K \times V \\
 &= 0.03\text{h}^{-1} \times 25\text{L} \\
 &= 0.75\text{L/h} \\
 &= 750\text{mL/h}
 \end{aligned}$$

5.

$$\begin{aligned}
 Cl &= K \times V \\
 K &= Cl / V \\
 &= 0.43\text{L/min} / 175\text{L} \\
 &= 0.43 \times 60 \text{ L/h} / 175\text{L} \\
 &= 25.8\text{L/h} / 175\text{L} \\
 &= 0.147 \text{ h}^{-1}
 \end{aligned}$$

$$\begin{aligned}
 T_{\text{half}} &= 0.693 / K \\
 &= 0.693 / 0.147 \text{ h}^{-1} \\
 &= 4.71 \text{ hours}
 \end{aligned}$$

Please click the advert

Brain power

By 2020, wind could provide one-tenth of our planet's electricity needs. Already today, SKF's innovative know-how is crucial to running a large proportion of the world's wind turbines.

Up to 25 % of the generating costs relate to maintenance. These can be reduced dramatically thanks to our systems for on-line condition monitoring and automatic lubrication. We help make it more economical to create cleaner, cheaper energy out of thin air.

By sharing our experience, expertise, and creativity, industries can boost performance beyond expectations. Therefore we need the best employees who can meet this challenge!

The Power of Knowledge Engineering

Plug into The Power of Knowledge Engineering.
Visit us at www.skf.com/knowledge

SKF

Download free ebooks at bookboon.com

6.

$$\begin{aligned}
 K &= Cl / V \\
 &= 12.5\text{mL/min} / 12\text{L} \\
 &= 12.5 \times 60\text{mL/h} / 12\text{L} \\
 &= 750\text{mL/h} / 12\text{L} \\
 &= 0.75\text{L/h} / 12\text{L} \\
 &= 0.0625 \text{ h}^{-1}
 \end{aligned}$$

7.

$$\begin{aligned}
 Cl &= 1.5\text{mL/min/Kg} \times 85\text{Kg} \\
 &= 127.5\text{mL/min} \\
 &= 127.5 \times 60\text{mL/h} \\
 &= 7,650 \text{ mL/h} \\
 &= 7.65 \text{ L/h}
 \end{aligned}$$

Chapter 5

1.

$$\begin{aligned}
 C_t &= C_0 \times e^{-Kt} \\
 &= 154\text{ng/mL} \times e^{-0.075\text{h}^{-1} \times 12\text{h}} \\
 &= 154\text{ng/mL} \times e^{-0.9} \\
 &= 154\text{ng/mL} \times 0.407 \\
 &= 63\text{ng/mL}
 \end{aligned}$$

2.

$$\begin{aligned}
 V &= 0.92\text{L/Kg} \times 60\text{Kg} \\
 &= 55.2\text{L}
 \end{aligned}$$

$$\begin{aligned}
 C_0 &= D / V \\
 &= 95\text{mg} / 55.2\text{L} \\
 &= 1.72 \text{ mg/L}
 \end{aligned}$$

$$\begin{aligned}
 C_t &= C_0 \times e^{-Kt} \\
 &= 1.72\text{mg/L} \times e^{-0.155\text{h}^{-1} \times 24\text{h}} \\
 &= 1.72\text{mg/L} \times e^{-3.72} \\
 &= 1.72\text{mg/L} \times 0.0242 \\
 &= 0.042 \text{ mg/L} \\
 &= 42 \text{ microgram/L}
 \end{aligned}$$

(Note that t must be expressed in hours not days, to avoid mis-matching units)

3.

$$C_t = C_0 \times e^{-Kt}$$

$$C_t / C_0 = e^{-Kt}$$

$$1\text{mg/L} / 5.2\text{mg/L} = e^{-0.078\text{h}^{-1} \times t}$$

$$0.192 = e^{-0.078\text{h}^{-1} \times t} \quad (\text{Take natural logs of both sides})$$

$$\text{Ln}(0.192) = -0.078\text{h}^{-1} \times t$$

$$-1.650 = -0.078\text{h}^{-1} \times t$$

$$-1.650 / -0.078\text{h}^{-1} = t$$

$$t = 1.650 / 0.078\text{h}^{-1}$$

$$t = 21.2 \text{ hours}$$

4.

$$C_t = C_0 \times e^{-Kt}$$

$$C_t / C_0 = e^{-Kt}$$

$$2\text{mg/L} / 10\text{mg/L} = e^{-Kt}$$

$$0.2 = e^{-Kt} \quad (\text{Take natural logs of both sides})$$

$$\text{Ln}(0.2) = -K \times t$$

$$-1.609 = -K \times t$$

$$-1.609 = -K \times 24\text{h}$$

$$-K = -1.609 / 24\text{h}$$

$$K = 1.609 / 24\text{h}$$

$$K = 0.067\text{h}^{-1}$$

5.

$$\text{Cl} = K.V$$

$$= 0.15\text{h}^{-1} \times 125\text{L}$$

$$= 18.75 \text{ L/h}$$

$$\text{AUC} = \text{E.D} / \text{Cl}$$

$$= 1.0 \times 25\text{mg} / 18.75\text{L/h} \quad (\text{Dose is i.v., so } F = 1.0)$$

$$= 1.33 \text{ mg.h/L}$$

Chapter 6

1.

The lowest concentration to be plotted is 24ng/mL. As the next exact power of 10 below 24 is 10, the vertical axis should be numbered 10 to 100 on the first cycle and 100 to 1000 ng/mL on the second. The horizontal axis should be numbered from zero to 28 hours.

Graphical methods are somewhat imprecise, so the values you read off will probably differ slightly from those below, but should not be radically different.

$$C_0 = 220\text{ng/mL}$$

$$t_{\text{half}} = 8.5\text{h}$$

$$V = D / C_0$$

$$= 15\text{mg} / 220\text{ng/mL} \text{ (Units need to be made to match – there are several different ways this could be done)}$$

$$= 15,000\text{microgram} / 220\text{microgram/L}$$

$$= 68.2\text{L}$$

$$K = 0.693 / t_{\text{half}}$$

$$= 0.693 / 8.5\text{h}$$

$$= 0.0815\text{h}^{-1}$$

$$Cl = K \times V$$

$$= 0.0815\text{h}^{-1} \times 68.2\text{L}$$

$$= 5.56 \text{ L/h}$$

2.

$$K = \ln(C_1/C_2) / (t_2 - t_1)$$

$$= \ln(7.1\text{mg/L} / 0.8\text{mg/L}) / (12\text{h} - 2\text{h})$$

$$= \ln(8.875) / 10\text{h}$$

$$= 2.183 / 10\text{h}$$

$$= 0.218 \text{ h}^{-1}$$

Please click the advert

See the light!
The sooner you realize we are right,
the sooner your life will get better!

A bit over the top? Yes we know!

We are just that sure that we can make your
 media activities more effective.



Get "Bookboon's Free Media Advice"
 Email kbm@bookboon.com



CREDIT SUISSE

DAIMLER



Microsoft

bookboon.com

$$\begin{aligned}
 C_0 &= C_1 / e^{-Kt_1} \\
 &= 7.1\text{mg/L} / e^{-0.218\text{h}^{-1} \times 2\text{h}} \\
 &= 7.1\text{mg/L} / e^{-0.436} \\
 &= 7.1\text{mg/L} / 0.647 \\
 &= 11.0 \text{ mg/L}
 \end{aligned}$$

$$\begin{aligned}
 V &= D / C_0 \\
 &= 120\text{mg} / 11.0\text{mg/L} \\
 &= 10.9 \text{ L}
 \end{aligned}$$

3.

The answers from the spreadsheet should support those from the manual calculation.

Chapter 8

1.

$$\begin{aligned}
 \text{LD of salt} &= \text{Target} \times V / S \\
 &= 15\text{mg/L} \times 42\text{L} / 0.75 \\
 &= 840 \text{ mg}
 \end{aligned}$$

$$C_{ss} = R_{inf} / Cl$$

$$R_{inf} = C_{ss} \times Cl$$

(But allowing for use of a salt ...)

$$\begin{aligned}
 \text{Rinf of salt} &= C_{ss} \times Cl / S \\
 &= 15\text{mg/L} \times 5\text{L/h} / 0.75 \\
 &= 100\text{mg/h}
 \end{aligned}$$

2.

$$\begin{aligned}
 V &= 3\text{L/Kg} \times 70\text{Kg} \\
 &= 210 \text{ L}
 \end{aligned}$$

$$\begin{aligned}
 Cl &= 1.1\text{mL/min/Kg} \times 70\text{Kg} \\
 &= 77 \text{ mL/min}
 \end{aligned}$$

$$\text{Target} = \text{midrange concentration} = (2+8) / 2 = 5\text{microgram/L}$$

$$\begin{aligned}
 \text{LD} &= \text{Target} \times V \\
 &= 5\text{microgram/L} \times 210\text{L} \\
 &= 1050\text{microgram} \\
 &= 1.05\text{mg}
 \end{aligned}$$

$$C_{ss} = R_{inf} / Cl$$

$$R_{inf} = C_{ss} \times Cl$$

$$\begin{aligned} &= 5 \text{ microgram/L} \times 77 \text{ mL/min (Convert clearance to units of L/h)} \\ &= 5 \text{ microgram/L} \times (77 \times 60) \text{ mL/h} \\ &= 5 \text{ microgram/L} \times (77 \times 60 / 1000) \text{ L/h} \\ &= 5 \text{ microgram/L} \times 4.62 \text{ L/h} \\ &= 23.1 \text{ microgram/h} \end{aligned}$$

3.

$$C_{ss} = R_{inf} / Cl$$

$$\begin{aligned} &= 100 \text{ microgram/h} / 200 \text{ mL/min (Convert clearance to units of L/h)} \\ &= 100 \text{ microgram/h} / (200 \times 60) \text{ mL/h} \\ &= 100 \text{ microgram/h} / (200 \times 60 / 1000) \text{ L/h} \\ &= 100 \text{ microgram/h} / 12 \text{ L/h} \\ &= 8.3 \text{ microgram/L} \end{aligned}$$

4.

The stated concentration is half of C_{ss} and so this concentration will be achieved when the infusion has been underway for a time equivalent to one half-life of the drug.

$$K = Cl / V$$

$$\begin{aligned} &= 12 \text{ L/h} / 50 \text{ L} \\ &= 0.24 \text{ h}^{-1} \end{aligned}$$

$$t_{\text{half}} = 0.693 / K$$

$$\begin{aligned} &= 0.693 / 0.24 \text{ h}^{-1} \\ &= 2.9 \text{ h} \end{aligned}$$

Concentration will rise to 4.15 microgram/L after 2.9h of infusion.

5.

$$C_{ss} = R_{inf} / Cl$$

$$\begin{aligned} &= 10 \text{ mg/h} / 2 \text{ L/h} \\ &= 5 \text{ mg/L} \end{aligned}$$

$$K = Cl / V$$

$$\begin{aligned} &= 2 \text{ L/h} / 45 \text{ L} \\ &= 0.0444 \text{ h}^{-1} \end{aligned}$$

$$t_{\text{half}} = 0.693 / 0.0444 \text{ h}^{-1}$$

$$= 15.6 \text{ h}$$

The time mentioned in the question (32.2h) is equivalent to two elimination half-lives. Hence concentration will have risen to 75% of C_{ss} .

$$\begin{aligned} \text{Conc at 31.2h} &= C_{ss} \times 0.75 \\ &= 5\text{mg/L} \times 0.75 \\ &= 3.75\text{mg/L} \end{aligned}$$

Chapter 9

1.

$$\begin{aligned} \text{AUC}_{iv} &= \text{F.D} / \text{Cl} \\ &= 1.0 \times 15\text{mg} / 5.26\text{L/h} \\ &= 2.85 \text{ mg.h/L} \end{aligned}$$

| Trapez no. | Start time (h) | End time (h) | Width (h) | Start conc (ng/mL) | End conc (ng/mL) | Average conc (ng/mL) | Area (ng.h/mL) |
|------------------------|----------------|--------------|-----------|--------------------|------------------|----------------------|-------------------|
| 1 | 0 | 1 | 1-0 =1 | 0 | 55 | (0+55)/2 = 27.5 | 1 x 27.5 = 27.5 |
| 2 | 1 | 2 | 2-1 =1 | 55 | 150 | (55+150)/2 = 102.5 | 1 x 102.5 = 102.5 |
| 3 | 2 | 4 | 4-2 =2 | 150 | 104 | (150+104)/2 = 127 | 2 x 127 = 254 |
| 4 | 4 | 8 | 8-4 =4 | 104 | 63 | (104+63)/2 = 83.5 | 4 x 83.5 = 334 |
| 5 | 8 | 14 | 14-8=6 | 63 | 41 | (63+41)/2 = 52 | 6 x 52 = 312 |
| 6 | 14 | 24 | 24-14=10 | 41 | 21 | (41+21)/2 = 31 | 10 x 31 = 310 |
| Total area zero to 24h | | | | | | | = 1340 |

Trust and responsibility

NNE and Pharmaplan have joined forces to create NNE Pharmaplan, the world’s leading engineering and consultancy company focused entirely on the pharma and biotech industries.

Inés Aréizaga Esteva (Spain), 25 years old
Education: Chemical Engineer

– You have to be proactive and open-minded as a newcomer and make it clear to your colleagues what you are able to cope. The pharmaceutical field is new to me. But busy as they are, most of my colleagues find the time to teach me, and they also trust me. Even though it was a bit hard at first, I can feel over time that I am beginning to be taken seriously and that my contribution is appreciated.

Please click the advert



NNE Pharmaplan is the world’s leading engineering and consultancy company focused entirely on the pharma and biotech industries. We employ more than 1500 people worldwide and offer global reach and local knowledge along with our all-encompassing list of services.
nnepharmaplan.com

nne pharmaplan®

Draw a semi-log graph of concentration versus time. The last three observations form a terminal linear portion. $t_{1/2}$ is approximately 10.2h

$$\begin{aligned} K &= 0.693 / t_{1/2} \\ &= 0.693 / 10.2\text{h} \\ &= 0.068\text{h}^{-1} \end{aligned}$$

$$\begin{aligned} \text{Tail area} &= \text{final conc} / K \\ &= 21\text{ng/ml} / 0.068\text{h}^{-1} \\ &= 309 \text{ ng.h/mL} \end{aligned}$$

$$\begin{aligned} \text{AUC}_{\text{oral}} &= 1340 + 309 \text{ ng.h/mL} \\ &= 1649 \text{ ng.h/mL} \\ &= 1.65 \text{ microgram.h/mL} \\ &= 1.65 \text{ mg.h/L} \end{aligned}$$

$$\begin{aligned} F &= \text{AUC}_{\text{oral}} / \text{AUC}_{\text{iv}} \\ &= 1.65\text{mg.h/L} / 2.85\text{mg.h/L} \\ &= 58\% \end{aligned}$$

One of the doses was i.v., so this is the absolute oral bioavailability

Chapter 10

1.

$$\begin{aligned} C_{ss,av} &= F \cdot D / Cl \cdot \tau \\ &= 0.85 \times 100\text{mg} / (45\text{mL/min} \times 12\text{h}) && \text{Convert clearance to L/h} \\ &= 0.85 \times 100\text{mg} / (45 \times 60\text{mL/h} \times 12\text{h}) \\ &= 0.85 \times 100\text{mg} / (45 \times 60 / 1000 \text{ L/h} \times 12\text{h}) \\ &= 85\text{mg} / 32.4\text{L} \\ &= 2.62 \text{ mg/L} \end{aligned}$$

2.

Target concentration = mid-range = 7mg/L

$$\begin{aligned} Cl &= K \times V \\ &= 0.035\text{h}^{-1} \times 95\text{L} \\ &= 3.33 \text{ L/h} \end{aligned}$$

$$C_{ss,av} = F \cdot D / Cl \cdot \tau$$

$$\begin{aligned} D &= C_{ss,av} \times Cl \times \tau / F \\ &= 7\text{mg/L} \times 3.33\text{L/h} \times 12\text{h} / 1.0 \\ &= 280\text{mg} \end{aligned}$$

(This will need to be adjusted to some dose size that is pharmaceutically available – probably 250 or 300mg)

$$\begin{aligned} LD &= \text{Target} \times V \\ &= 7\text{mg/L} \times 95\text{L} \\ &= 665\text{mg} \end{aligned}$$

(Loading requires us to deliver $665 - 280 = 385\text{mg}$ additional to the first regular sized dose. If this is too much as a single dose, the additional 385mg may be split, adding (maybe) 200mg to the first regular dose and 185mg to the second)

3.

$$\begin{aligned} Cl &= 11\text{mL/min/Kg} \times 50\text{Kg} \\ &= 550\text{mL/min} \end{aligned}$$

$$C_{ss,av} = F \cdot D / Cl \cdot \tau$$

$$D = C_{ss,av} \times Cl \times \tau / F$$

$$= 50\text{microgram/L} \times 550\text{mL/h} \times 24\text{h} / 0.7$$

$$= 50\text{microgram/L} \times 0.55\text{L/h} \times 24\text{h} / 0.7$$

$$= 943 \text{ microgram}$$

(Make all volumes in same units – Litres)

$$\begin{aligned} \text{Dose adjusted for salt factor} &= 943\text{microgram} / 0.8 \\ &= 1,179 \text{ microgram} \\ &= \text{Approx } 1.2\text{mg} \end{aligned}$$

4.

$$\begin{aligned} C_{ss,max} &= D/V \times 1/(1 - e^{-k\tau}) \\ &= 120\text{mg} / 45\text{L} \times 1/(1 - e^{-0.12\text{h}^{-1} \times 8\text{h}}) \\ &= 2.67\text{mg/L} \times 1/(1 - e^{-0.96}) \\ &= 2.67\text{mg/L} \times 1/(1 - 0.383) \\ &= 2.67\text{mg/L} \times 1/(0.617) \\ &= 2.67\text{mg/L} \times 1.62 \\ &= 4.33\text{mg/L} \end{aligned}$$

$$\begin{aligned} C_{ss,min} &= C_{ss,max} - D/V \\ &= 4.33\text{mg/L} - 120\text{mg}/45\text{L} \\ &= 4.33 - 2.67\text{mg/L} \\ &= 1.66\text{mg/L} \end{aligned}$$

5.

$$\begin{aligned} Cl &= 1.5\text{mL/min/Kg} \times 65\text{Kg} \\ &= 97.5\text{mL/min} \end{aligned}$$

$$\begin{aligned}
 V &= 0.71\text{L/Kg} \times 65\text{Kg} \\
 &= 46.2\text{L} \\
 K &= 97.5\text{mL/min} / 46.2\text{L} \quad (\text{Convert to units of L and h}) \\
 &= 97.5 \times 60 / 1000\text{L/h} / 46.2\text{L} \\
 &= 5.85\text{L/h} / 46.2\text{L} \\
 &= 0.127\text{h}^{-1}
 \end{aligned}$$

$$\begin{aligned}
 C_{ss,max} &= D/V \times 1/(1 - e^{-k\tau}) \\
 &= 20\text{mg}/46.2 \times 1/(1 - e^{-0.127\text{h}^{-1} \times 12\text{h}}) \\
 &= 0.433\text{mg/L} \times 1/(1 - e^{-1.524}) \\
 &= 0.433\text{mg/L} \times 1/(1 - 0.218) \\
 &= 0.433\text{mg/L} \times 1/(0.782) \\
 &= 0.433\text{mg/L} \times 1.28 \\
 &= 0.554 \text{ mg/L}
 \end{aligned}$$

$$\begin{aligned}
 C_{ss,min} &= C_{ss,max} - D/V \\
 &= 0.554\text{mg/L} - 20\text{mg}/46.2\text{L} \\
 &= 0.554\text{mg/L} - 0.433\text{mg/L} \\
 &= 0.121 \text{ mg/L}
 \end{aligned}$$

Please click the advert

THE MILKWAY
LAUNCHING GRADUATE CAREERS

MILKROUND SYSTEM
Become a business star with internships, placements, graduate jobs & schemes from leading companies.
www.milkround.com

PLANET CAREER ADVICE
Inhabited by insights into business careers and orbited by application advice.

FIRST CONTACT
Get matched to top business employers via intelligent emails landing in your inbox.

Milkround.com: rated the #1 graduate recruitment website in the UK Graduate Careers Survey 2009 of 16,000 university finalists.

Milkround.com

6.

We need peaks of about 8 mg/L and troughs of less than 1 mg/L, so concentration need to fall about eight fold between peak and trough. The dosage interval therefore needs to be equivalent to three half-lives.

$$\begin{aligned} t\text{-half} &= 0.693 / K \\ &= 0.693 / 0.09\text{h}^{-1} \\ &= 7.7 \text{ hours} \end{aligned}$$

Dosage interval needs to be $3 \times 7.7 = 23.1$ hours.

Nearest practical figure is 24 hours.

Use the spreadsheet and try different doses with dosage interval set to 24h. A daily dose of 120mg (or thereabouts) would be satisfactory.

Chapter 13

1.

To use the XL spreadsheet, you should have converted the concentrations to units of mg/L by dividing by 1000 (1ng/mL = 1microgram/L = 0.001mg/L). You would then find the optimized values are:

$$\begin{aligned} V &= 70.4 \text{ L} \\ K &= 0.075 \text{ h}^{-1} \\ Cl &= 5.26 \text{ L/h} \end{aligned}$$

Chapter 14

1.

$$\begin{aligned} CrCl &= \frac{1.04 \times (140 - \text{Age}) \times \text{Wt}}{\text{SrCr}} \\ &= \frac{1.04 \times (140 - 62) \times 58}{49} \\ &= 96.0 \text{ mL/min} \\ &= 96.0 \times 60 / 1000 \text{ L/h} \\ &= 5.76 \text{ L/h} \end{aligned}$$

2.

$$\begin{aligned} CrCl &= \frac{1.04 \times (140 - \text{Age}) \times \text{Wt}}{\text{SrCr}} \\ &= \frac{1.04 \times (140 - 44) \times 54}{127} \\ &= 42.5 \text{ mL/min} \end{aligned}$$

$$\begin{aligned}\text{Digoxin clearance} &= \text{CrCl} + 0.33 \times \text{BodyWeight mL/min} \\ &= 42.5 + 0.33 \times 54 \text{ mL/min} \\ &= 42.5 + 17.8 \text{ mL/min} \\ &= 60.3 \text{ mL/min} \\ &= 60.3 \times 60 / 1000 \text{ L/h} \\ &= 3.62 \text{ L/h}\end{aligned}$$

$$C_{ss,av} = \frac{F \cdot D}{Cl \cdot \tau}$$

$$\begin{aligned}D &= \frac{C_{ss,av} \times Cl \times \tau}{F} \\ &= \frac{1.4 \text{ microgram/L} \times 3.62 \text{ L/h} \times 24 \text{ h}}{0.7} \\ &= 174 \text{ microgram}\end{aligned}$$

Nearest pharmaceutically realistic dose = 3 x 62.5 = 187.5 microgram

3.

Spreadsheet should agree with the manually calculated creatinine clearance (Q1) and the digoxin clearance and dosage (Q2).