

# Molecular Identification of Fungi

Youssuf Gherbawy  
Kerstin Voigt  
*Editors*



 Springer

# Molecular Identification of Fungi

Youssuf Gherbawy • Kerstin Voigt  
Editors

# Molecular Identification of Fungi

 Springer

*Editors*

Prof. Dr. Youssuf Gherbawy  
South Valley University  
Faculty of Science  
Department of Botany  
83523 Qena, Egypt  
youssuf\_gherbawy@hotmail.com

Dr. Kerstin Voigt  
University of Jena  
School of Biology and Pharmacy  
Institute of Microbiology  
Neugasse 25  
07743 Jena, Germany  
kerstin.voigt@uni-jena.de

ISBN 978-3-642-05041-1 e-ISBN 978-3-642-05042-8  
DOI 10.1007/978-3-642-05042-8  
Springer Heidelberg Dordrecht London New York

Library of Congress Control Number: 2009938949

© Springer-Verlag Berlin Heidelberg 2010

This work is subject to copyright. All rights are reserved, whether the whole or part of the material is concerned, specifically the rights of translation, reprinting, reuse of illustrations, recitation, broadcasting, reproduction on microfilm or in any other way, and storage in data banks. Duplication of this publication or parts thereof is permitted only under the provisions of the German Copyright Law of September 9, 1965, in its current version, and permission for use must always be obtained from Springer. Violations are liable to prosecution under the German Copyright Law.

The use of general descriptive names, registered names, trademarks, etc. in this publication does not imply, even in the absence of a specific statement, that such names are exempt from the relevant protective laws and regulations and therefore free for general use.

*Cover design:* WMXDesign GmbH, Heidelberg, Germany, kindly supported by 'leopardy.com'

Printed on acid-free paper

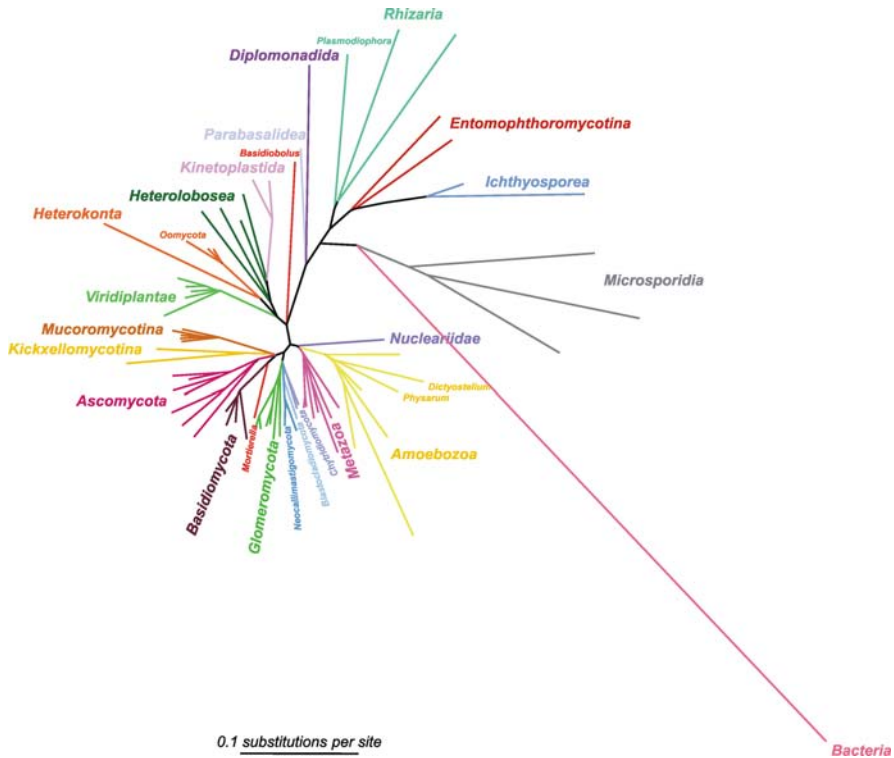
Springer is part of Springer Science+Business Media (www.springer.com)

*Dedicated to Prof. Lajos Ferenczy (1930–2004) microbiologist, mycologist and member of the Hungarian Academy of Sciences, one of the most outstanding Hungarian biologists of the twentieth century*

# Preface

Fungi comprise a vast variety of microorganisms and are numerically among the most abundant eukaryotes on Earth's biosphere. They enjoy great popularity in pharmaceutical, agricultural, and biotechnological applications. Recent advances in the decipherment of whole fungal genomes promise a continuation and acceleration of these trends. New techniques become available to facilitate the genetic manipulation of an increasing number of fungal organisms to satisfy the demand of industrial purposes. The increasing importance-driven search of novel detection techniques and new fungal species initiated the idea for a book about the molecular identification of fungi.

The kingdom of the fungi (Mycota) appears as the sister group of the multicellular animals (Metazoa) as an independent, apparently monophyletic group within the domain Eukarya, equal in rank to green plants (Viridiplantae) and animals (Metazoa). Fungi are originally heterotrophic eukaryotic microorganisms harboring chitin in their cell walls and lacking plastids in their cytoplasm. Formerly, the oomycetes, slime moulds and plasmodiophorids were considered as fungi based on their ability to produce fungus-like hyphae or resting spores. Whereas the Oomycota are classified to the stramenopile algae (Chromista or Heterokonta), and the plasmodial and cellular slime moulds (Mycetozoa) belong to the Amoebozoa. The Plasmodiophoromycota are among the cercozoan Rhizaria closely related to the foraminifers. A three-protein phylogeny of the fungi and their allies confirms that the nucleariids, phagotrophic amoebae with filose pseudopods in soil and freshwater, may represent descendants of a common ancestor at the animal–fungal boundary (Fig. 1). The fungal kingdom encompasses the Asco-, Basidio-, Glomero-, Zygo- and Chytridiomycota. The former four phyla are terrestrial fungi developing nonflagellated spores (aplanosporic), whereas the Chytridiomycota represent aquatic and zoosporic (planosporic) fungi, which split into three individual taxon groups, the aerobic Blastocladio- and Chytridiomycota *sensu stricto* and the anaerobic Neocallimastigomycota. The Zygomycota are among the most basal terrestrial fungi, which evolved in a paraphyletic manner. Hence, the phylum was divided into different subphyla,

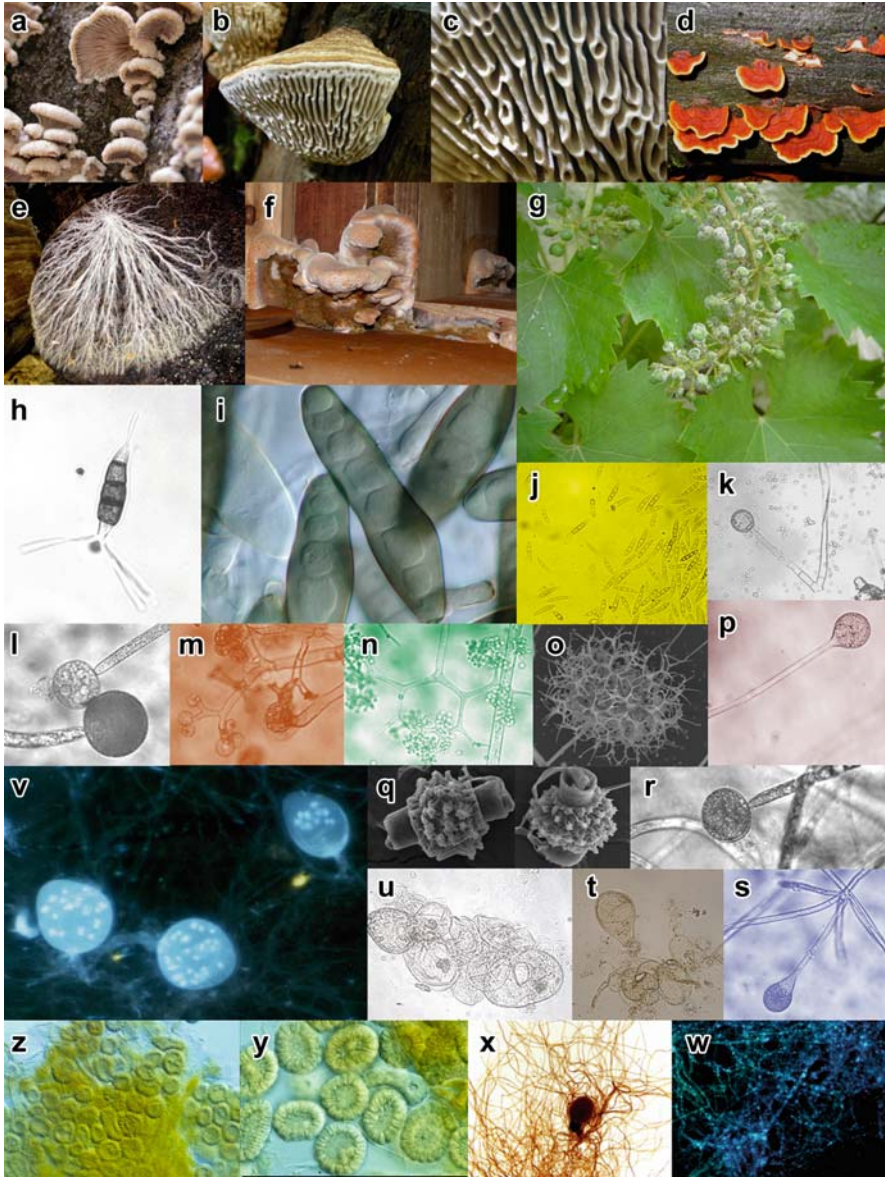


**Fig. 1** The evolution of the fungi and allied fungi-like microorganisms based on a concatenated neighbor-joining analysis using mean character differences as distance measure on 1,262 aligned amino acid characters comprising translation elongation factor 1 alpha, actin, and beta-tubulin (500, 323 and 439 characters, respectively) from 80 taxa. The prokaryotic elongation factor Tu, MreB (TM1544), and FtsZ (both homologous to actin and tubulin, respectively) from *Thermotoga maritima* were used as out group taxon representing the bacterial domain

the Mucoro-, Kickxello-, Zoopago- and Entomophthoromycotina, whose phylogenetic relationships are not fully understood yet. In the phylogenetic tree shown in Fig. 1, the Entomophthoromycotina group together with the Ichthyosporea, a relationship, is not well supported by clade stability proportions.

Fungi develop a wide diversity of morphological features, which are shared with many fungi-like microorganisms (Fig. 2), among those the white rust and downy mildew “fungi” (Fig. 2g) are obligate parasites of plants and develop fungus-like hyphae with haustoria (ht) in asexual and thick-walled, ornamented oospores (os) from fertilized oospheres after fusion of an oogonium (og) with an antheridium (at) during sexual reproduction (Fig. 3).

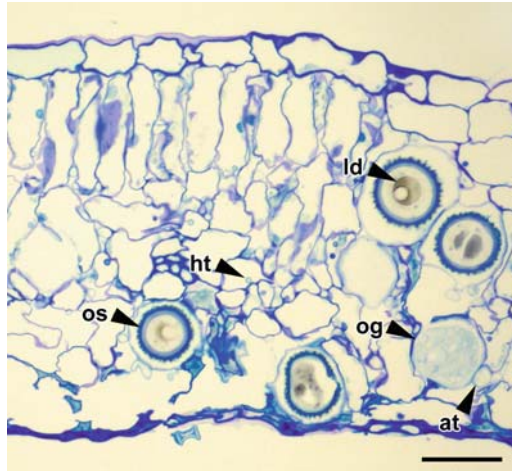
The distribution of fungi among the various ecological niches of the biosphere seems to be infinite. Estimates suggest a total of 1.5 million fungal species, only less than a half has been merely described yet. This implies a backlog demand, which comes along with a rising importance of novel techniques for a rapid and



**Fig. 2** The morphological diversity of fungi and fungi-like microorganisms. (a–f): basidiomycetes (Agaricomycotina; Photos: M. Kirchmair); (g) oomycetes (Peronosporales; Photo: O. Spring); (h–j): multicellular conidia from imperfect stages of ascomycetes (Pezizomycotina); (k–s): zygomycetes (Mucoromycotina; Photos: K. Hoffmann, scanning electron microphotographs o & q: M. Eckart & K. Hoffmann); (k, l, p, r, s) – different types of multisporous sporangia, (m, n, o): different types of uni-fewspored sporangia; (t–x): reproductive structures (zoosporangia) from anaerobic chytridiomycetes (Neocallimastigomycota; Photos: K. Fliegerova); (y, z): plasmodiophorids (Plasmodiophoromycota; Photos: S. Neuhauser & M. Kirchmair).



**Fig. 3** Cross-section of a leaf infected with *Pustula tragopogonis* (Peronosporales, Oomycota) causing white rust on sunflower. The microphotograph shows structures, which are typical for the sexual reproduction of oomycetes: ht – haustorium, ld – lipid droplet inside an oospore, os – oospore, og – oogonium, at – antheridium fused to an oogonium (Photo: A. Heller)



unambiguous detection and identification of fungi to explore the fungal diversity as a coherent whole. Molecular techniques, particularly the technology of the polymerase chain reaction, have revolutionized the molecular biology and the molecular diagnosis of fungi. The incorporation of molecular techniques into what has been traditionally considered as morphology-based taxonomy of fungi helps us in the differentiation of fungal species and varieties. Databases of genomes and genetic markers used as sources for molecular barcodes are being created and the fungal world is in progress to be unveiled with the help of bioinformatics tools. Genome projects provide evidence for ancient insertion elements, proviral or prophage remnants, and many other patches of unusual composition. Consequently, it becomes increasingly important to pinpoint genes, which characterize fungal organisms at different taxonomic levels without the necessity of previous cultivation. Unfortunately, the initiative of an excessive use of molecular barcoding has been hampered by a lack of sufficient and novel synapomorphic nucleotide

←

**Fig. 2** (continued) (a) – basidiocarp of *Schizophyllum commune*, (b) – basidiocarp of *Daedalea quercina*, (c) – hymenophor from basidiocarp of *Daedalea quercina*, (d) – basidiocarp of *Trametes* sp., (e) – mycelium of *Antrodia* sp spreading over a trunk of a tree, (f) – dry rot caused by *Serpula lacrymans* on timber, (g) – symptomatology from *Plasmopara viticola*, the causal agent of grapevine downy mildew, (h) – *Pestalotiopsis clavispora* (Photo: C. Kesselboth), (i) – *Bipolaris* cf. *sorokiniana* (Photo: G. Newcombe), (j) – *Fusarium* sp. (Photo: C. Kesselboth), (k) – *Mucor indicus*, (l) – *Helicostylum elegans*, (m) – *Thamnidium elegans*, (n) – *Dichotomocladium* sp., (o) – *Dichotomocladium robustum*, (p) – *Absidia psychrophilia*, (q) – zygospores from *Lentamyces parricida*, (r) – *Mucor rouxii*, (s) – *Absidia cylindrospora*, (t) – *Caecomyces* sp. isolated from sheep (lugol staining), (u) – *Caecomyces* sp. isolated from sheep, (v) – *Neocallimastix frontalis* (bisbenzimid staining of nuclei), (w) – *Anaeromyces mucronatus* isolated from cow (bisbenzimid staining of nuclei), (x) – *Neocallimastix frontalis* isolated from cow (lugol staining); (y) – thick walled resting spores from *Sorosphaera veronicae*, (z) – sporosori from *Sorosphaera veronicae*

characters and signature sequences. Moreover, high intraspecific variability of conventional molecular characters makes it difficult to identify species borders. However, DNA sequences and other genetic markers provide large amounts of data which are cultivation-independent and do not depend on physiological inconsistencies. Genetic markers constantly reflect the identification treasure hidden in the genetic information and allow to control the degree of resolution by choosing the appropriate genes.

In this book, we highlight the advances of the past decade, both in methodology and in the understanding of genomic organization and approach problems of the identification and differentiation of fungi using molecular markers and compare those with classical procedures traditionally used for species designation. The limitations in the availability of type material, reference strains, and reference nucleotide sequences set boundaries in the molecular identification. For example, the image displaying multicellular, melanin-pigmented conidia (size: 90  $\mu\text{m}$ ) from strain CID1670 (Fig. 2i), which was kindly provided by George Newcombe (University of Idaho, Center for Research on Invasive Species and Small Populations, Moscow, ID, USA), may serve as an appropriate cautionary note for readers of this book. The strain was recovered as an endophytic ascomycete from the asterid perennial herb *Centaurea stoebe* (spotted knapweed). The fungus could be attributed by conventional ITS barcoding to the pleosporalean genus *Drechslera* and in a narrower sense to *Bipolaris sorokiniana*. Since species of *Bipolaris* had never been reported from any species of *Centaurea* in earlier reports, neither its effects on its host nor the final taxonomic delimitation are known. Nucleotide sequences of additional genes and a more in-depth phylogenetic study may even suggest that this strain was a new species. Therefore, it would make sense to distinguish between refined identification of fungi uncommonly found in exceptional biotopes in order to explore new species, e.g., as endophytes, and high-throughput molecular identification of well-studied fungi in order to serve the needs of industrial application.

The role of fungi as pathogens of evolutionarily naive plants including a hypothesis about the plant invasion-mediated progression of novel phytopathogens will be discussed in the first chapter. The second and third chapter concerns with the diagnostics and the challenge to identify “fungus-like” plant pathogens from the oomycetes and the plasmodiophorids, respectively. The fourth chapter leads over the applications of molecular markers and DNA sequences in the identification of fungal pathogens in grain legumes and cereals followed by various aspects of qualitative and quantitative detection of *Fusarium* spp. and *Macrophomina phaseolina*, pathogenic on maize and other corn crops or economic plants. During the course of the book, the detection of ochratoxigenic fungi, mainly aspergilli and penicilli, and other postharvest pathogens like *Mucor* and *Rhizopus* is elucidated. The molecular identification of wood rotting and endophytic fungi as well as anaerobic rumen fungi finish the first part on plant pathological and environmental biological aspects. The second part deals with human pathological and clinical aspects. The introduction gives a contribution about new approaches in fungal DNA preparation from whole blood following multiplex PCR detection. Novel techniques in the depletion of the background host DNA in favour of enrichment of the

fungal contaminant DNA following different modifications of PCR approaches represent powerful tools in the detection of a wide variety of human pathogenic fungi causing sepsis and other life-threatening diseases that result from excessive host responses to fungal infections. The survey continues with conventional strategies for the molecular detection of *Malassezia*, dermatophytes, opportunistic fungi, and causative agents of deep mycoses as well as paracoccidioidomycosis and *Ochroconis gallopava* infection via a novel tool, the loop-mediated isothermal amplification method (LAMP). The book closes with reviews about prospects and perspectives of molecular markers for the identification of *Absidia*-like fungi and other zygomycetes.

The editors thank all contributors for their valuable reviews and comments, which were crucial for the accomplishment of this book. Furthermore, we express our gratitude to all authors who contributed figures and images for the cover and miscellaneous parts adding a great deal to the illustration of this book. The cover of the book was kindly supported by “leography.com.”

January 2010

*Youssuf Gherbawy*  
*Kerstin Voigt*

# Contents

## Part I Plant Pathological and Environmental Biological Aspects

<b>1 Fungal Pathogens of Plants in the Homogocene</b> .....	3
George Newcombe and Frank M. Dugan	
<b>2 Molecular Techniques for Classification and Diagnosis of Plant Pathogenic Oomycota</b> .....	35
Otmar Spring and Marco Thines	
<b>3 Plasmodiophorids: The Challenge to Understand Soil-Borne, Obligate Biotrophs with a Multiphasic Life Cycle</b> .....	51
Sigrid Neuhauser, Simon Bulman, and Martin Kirchmair	
<b>4 Applications of Molecular Markers and DNA Sequences in Identifying Fungal Pathogens of Cool Season Grain Legumes</b> .....	79
Evans N. Njambere, Renuka N. Attanayake, and Weidong Chen	
<b>5 Quantitative Detection of Fungi by Molecular Methods: A Case Study on <i>Fusarium</i></b> .....	93
Kurt Brunner and Robert L. Mach	
<b>6 DNA-Based Tools for the Detection of <i>Fusarium</i> spp. Pathogenic on Maize</b> .....	107
Ivan Visentin, Danila Valentino, Francesca Cardinale, and Giacomo Tamietti	
<b>7 Molecular Detection and Identification of <i>Fusarium oxysporum</i></b> .....	131
Ratul Saikia and Narendra Kadoo	

<b>8</b>	<b>Molecular Chemotyping of <i>Fusarium graminearum</i>, <i>F. culmorum</i>, and <i>F. cerealis</i> Isolates From Finland and Russia</b> .....	159
	Tapani Yli-Mattila and Tatiana Gagkaeva	
<b>9</b>	<b>Molecular Characterization and Diagnosis of <i>Macrophomina phaseolina</i>: A Charcoal Rot Fungus</b> .....	179
	Bandamaravuri Kishore Babu, Ratul Saikia, and Dilip K Arora	
<b>10</b>	<b>Molecular Diagnosis of Ochratoxigenic Fungi</b> .....	195
	Daniele Sartori, Marta Hiromi Taniwaki, Beatriz Iamanaka, and Maria Helena Pelegrinelli Fungaro	
<b>11</b>	<b>Molecular Barcoding of Microscopic Fungi with Emphasis on the Mucoralean Genera <i>Mucor</i> and <i>Rhizopus</i></b> .....	213
	Youssuf Gherbawy, Claudia Kesselboth, Hesham Elhariry, and Kerstin Hoffmann	
<b>12</b>	<b>Advances in Detection and Identification of Wood Rotting Fungi in Timber and Standing Trees</b> .....	251
	Giovanni Nicolotti, Paolo Gonthier, and Fabio Guglielmo	
<b>13</b>	<b>Molecular Diversity and Identification of Endophytic Fungi</b> .....	277
	Liang-Dong Guo	
<b>14</b>	<b>Molecular Identification of Anaerobic Rumen Fungi</b> .....	297
	Martin Eckart, Katerina Fliegerová, Kerstin Hoffmann, and Kerstin Voigt	
 <b>Part II Human Pathological and Clinical Aspects</b>		
<b>15</b>	<b>New Approaches in Fungal DNA Preparation from Whole Blood and Subsequent Pathogen Detection Via Multiplex PCR</b> ....	317
	Roland P. H. Schmitz, Raimund Eck, and Marc Lehmann	
<b>16</b>	<b>Classification of Yeasts of the Genus <i>Malassezia</i> by Sequencing of the ITS and D1/D2 Regions of DNA</b> .....	337
	Lidia Pérez-Pérez, Manuel Pereiro, and Jaime Toribio	
<b>17</b>	<b>DNA-Based Detection of Human Pathogenic Fungi: Dermatophytes, Opportunists, and Causative Agents of Deep Mycoses</b> .....	357
	Lorenza Putignani, Silvia D'Arezzo, Maria Grazia Paglia, and Paolo Visca	

**18 Applications of Loop-Mediated Isothermal Amplification Methods (LAMP) for Identification and Diagnosis of Mycotic Diseases: Paracoccidioidomycosis and *Ochroconis gallopava* infection** ..... 417  
Ayako Sano and Eiko Nakagawa Itano

**19 Identification of the Genus *Absidia* (Mucorales, Zygomycetes): A Comprehensive Taxonomic Revision** ..... 439  
Kerstin Hoffmann

**20 Molecular Characters of Zygomycetous Fungi** ..... 461  
Xiao-yong Liu and Kerstin Voigt

**Index** ..... 489

# Contributors

**Dilip K. Arora** National Bureau of Agriculturally Important Microorganisms (ICAR), Mau, Uttar Pradesh 275101, India, aroradilip@yahoo.co.in

**Renuka N. Attanayake** Department of Plant Pathology, Washington State University, Pullman, WA 99164, USA

**Kurt Brunner** Institute of Chemical Engineering, Research Area Gene Technology and Applied Biochemistry, Gene Technology Group, Vienna University of Technology, Getreidemarkt 9, A-1060 Vienna

**Simon Bulman** Plant & Food Research, Private Bag 4704, Christchurch, New Zealand; Bio-Protection Research Centre, Lincoln University, P.O. Box 84, 7647 Canterbury, New Zealand

**Francesca Cardinale** DiVaPRA – Plant Pathology, University of Turin, I-10095 Grugliasco, Turin, Italy

**Weidong Chen** Department of Plant Pathology, Washington State University, Pullman, WA 99164, USA; USDA ARS Grain Legume Genetics and Physiology Research Unit, Washington State University, Pullman, WA 99164, USA, w-chen@wsu.edu

**Silvia D’Arezzo** National Institute for Infectious Diseases “Lazzaro Spallanzani” I.R.C.C.S., Via Portuense 292, 00149 Rome, Italy

**Frank M. Dugan** USDA-ARS, Washington State University, Pullman, WA 99163-6402, USA

**Raimund Eck** SIRS-Lab GmbH, Winzerlaer Str. 2, 07745 Jena, Germany

**Martin Eckart** Institute of Microbiology, School of Biology and Pharmacy, University of Jena, Neugasse 25, 07743 Jena, Germany, martin.eckart@uni-jena.de

**Hesham Elhariry** Biological Sciences Department, Faculty of Science, Taif University, P.O. Box 888 Taif, Kingdom of Saudi Arabia

**Katerina Fliegerová** Department of Biological Basis of Food Quality and Safety, Institute of Animal Physiology and Genetics, Czech Academy of Sciences, v.v.i., Vídeňská 1083, 14220 Prague 4, Czech Republic, fliegerova@iapg.cas.cz

**Tatiana Gagkaeva** Laboratory of Mycology and Phytopathology, All-Russian Institute of Plant Protection (VIZR), 196608 St. Petersburg-Pushkin, Russia, t.gagkaeva@yahoo.com

**Youssuf Gherbawy** Botany Department, Faculty of Science, South Valley University, 83523 Qena, Egypt

**Paolo Gonthier** Di.Va.P.R.A., Department of Exploitation and Protection of the Agricultural and Forestry Resources, Plant Pathology, University of Torino, via L. da Vinci 44, I-10095 Grugliasco (TO), Italy

**Maria Grazia Paglia** National Institute for Infectious Diseases “Lazzaro Spallanzani” I.R.C.C.S., Via Portuense 292, 00149 Rome, Italy

**Fabio Guglielmo** Di.Va.P.R.A., Department of Exploitation and Protection of the Agricultural and Forestry Resources, Plant Pathology, University of Torino, via L. da Vinci 44, I-10095 Grugliasco (TO), Italy

**Liang-Dong Guo** Systematic Mycology & Lichenology Laboratory, Institute of Microbiology, Chinese Academy of Sciences, Beijing 100101, China, guold@sun.im.ac.cn

**Kerstin Hoffmann** Institute of Microbiology, School of Biology and Pharmacy, University of Jena, Neugasse 25, 07743 Jena, Germany, Hoffmann.Kerstin@uni-jena.de

**Beatriz Iamanaka** Departamento de Biologia Geral, Centro de Ciências Biológicas, Universidade Estadual de Londrina, Caixa Postal 6001, CEP 86051-970 Londrina-Paraná, Brazil

**Eiko Nakagawa Itano** Department of Pathological Science, CCB, State University of Londrina, P.O. Box 6001, 86051-970 Londrina, Paraná, Brazil, itanoeiko@hotmail.com



**Narendra Kadoo** PMB Group, Biochemical Sciences Division, National Chemical Laboratory, Pune 411008, Maharashtra, India, ny.kadoo@ncl.res.in

**Claudia Kesselboth** Botany Department, Faculty of Science, South Valley University, 83523 Qena, Egypt

**Martin Kirchmair** Institute of Microbiology, Leopold Franzens – University Innsbruck, Technikerstr. 25, 6020 Innsbruck, Austria, Martin.Kirchmair@uibk.ac.at

**Bandamaravuri Kishore Babu** National Bureau of Agriculturally Important Microorganisms (ICAR), Mau, Uttar Pradesh 275101, India, aroradilip@yahoo.co.in; present address: Environmental Microbiology Lab, Department of Environmental Engineering, Chosun University, Gwang ju-501759, South Korea, kishore\_bandam@yahoo.co.in

**Marc Lehmann** SIRS-Lab GmbH, Winzerlaer Str. 2, 07745 Jena, Germany

**Xiao-yong Liu** Key Laboratory of Systematic Mycology and Lichenology, Institute of Microbiology, Chinese Academy of Sciences, No. 1 Beichen West Road, Chaoyang District, Beijing 100101, P. R. China, liuxiaoyong@im.ac.cn

**Robert L. Mach** Institute of Chemical Engineering, Research Area Gene Technology and Applied Biochemistry, Gene Technology Group, Vienna University of Technology, Getreidemarkt 9, A-1060 Vienna, Austria, rmach@mail.zserv.tuwien.ac.at

**Sigrid Neuhauser** Institute of Microbiology, Leopold Franzens – University Innsbruck, Technikerstr. 25, 6020 Innsbruck, Austria

**George Newcombe** Department of Forest Resources, and Center for Research on Invasive Species and Small Populations, University of Idaho, Moscow, ID 83844-1133, USA, georgen@uidaho.edu

**Giovanni Nicolotti** Di.Va.P.R.A., Department of Exploitation and Protection of the Agricultural and Forestry Resources, Plant Pathology, University of Torino, via L. da Vinci 44, I-10095 Grugliasco (TO), Italy, giovanni.nicolotti@unito.it

**Evans N. Njambere** Department of Plant Pathology, Washington State University, Pullman, WA 99164, USA

**Maria Helena Pelegrinelli Fungaro** Departamento de Biologia Geral, Centro de Ciências Biológicas, Universidade Estadual de Londrina, Caixa Postal 6001, CEP 86051-970, Londrina-Paraná, Brazil, fungaro@uel.br

**Manuel Pereiro** Department of Dermatology, Laboratory of Mycology, Faculty of Medicine, University Hospital Complex of Santiago de Compostela, C/San Francisco S/N, 15706 Santiago de Compostela, Spain

**Lidia Pérez-Pérez** Department of Dermatology, University Hospital Complex of Vigo, C/Porriño 5, 36209 Vigo, Spain, lidiacomba@yahoo.es

**Lorenza Putignani** Microbiology Unit, Children's Hospital, Healthcare and Research Institute Bambino Gesù, Piazza Sant'Onofrio 4, 00165 Rome, Italy

**Ratul Saikia** Biotechnology Division, North-East Institute of Science & Technology, Jorhat 785006, Assam, India, rsaikia19@yahoo.com

**Ayako Sano** Medical Mycology Research Center, Chiba University, 1-8-1, Inohana, Chuo-ku, 260-8673 Chiba, Japan, aya1@faculty.chiba-u.jp

**Daniele Sartori** Centro de Ciências Biológicas, Departamento de Biologia Geral, Universidade Estadual de Londrina, Caixa Postal 6001, CEP 86051-970, Londrina-Paraná, Brazil

**Roland P.H. Schmitz** SIRS-Lab GmbH, Winzerlaer Str. 2, 07745 Jena, Germany, schmitz@sirs-lab.com

**Otmar Spring** Institute of Botany, University of Hohenheim, 70593 Stuttgart, Germany, spring@uni-hohenheim.de

**Giacomo Tamietti** DiVaPRA – Plant Pathology, University of Turin, I-10095 Grugliasco, Turin, Italy, giacomo.tamietti@unito.it

**Marta Hiromi Taniwaki** Departamento de Biologia Geral, Centro de Ciências Biológicas, Universidade Estadual de Londrina, Caixa Postal 6001, CEP 86051-970, Londrina-Paraná, Brazil

**Marco Thines** Institute of Botany, University of Hohenheim, 70593 Stuttgart, Germany

**Jaime Toribio** Department of Dermatology, Laboratory of Mycology, Faculty of Medicine, University Hospital Complex of Santiago de Compostela, C/San Francisco S/N, 15706 Santiago de Compostela, Spain

**Danila Valentino** DiVaPRA – Plant Pathology, University of Turin, I-10095 Grugliasco, Turin, Italy

**Paolo Visca** National Institute for Infectious Diseases “Lazzaro Spallanzani” I.R.C.C.S., Via Portuense 292, 00149 Rome, Italy; Department of Biology, University of Roma Tre, Viale Marconi 446, 00146 Rome, Italy, visca@uniroma3.it

**Ivan Visentin** DiVaPRA – Plant Pathology, University of Turin, I-10095 Grugliasco, Turin, Italy

**Kerstin Voigt** Institute of Microbiology, School of Biology and Pharmacy, University of Jena, Neugasse 25, 07743 Jena, Germany, kerstin.voigt@uni-jena.de

**Tapani Yli-Mattila** Laboratory of Plant Physiology and Molecular Biology, Department of Biology, University of Turku, FIN-20014 Turku, Finland, tymat@utu.fi

**Part I**  
**Plant Pathological and**  
**Environmental Biological Aspects**

# Chapter 1

## Fungal Pathogens of Plants in the Homogocene

George Newcombe and Frank M. Dugan

**Abstract** As the pace of biotic homogenization has accelerated over time, the threat of novel phytopathogens has become a question of growing importance for mycologists and plant pathologists. Meanwhile, this question is but one of a whole set of related questions that invasion biologists are attempting to answer. Pathogen release is of interest to both sets of scientists because it provides a measure of the extent to which previously isolated mycobiotas have undergone cryptic homogenization, and at the same time it is the basis for a promising hypothesis to explain plant invasions. We argue that only a fraction of all first encounters between novel pathogens and evolutionarily naive plants could result in susceptible outcomes. This is analogous to the fact that only a fraction of all plant introductions result in plant invasions.

### 1.1 Introduction

Geologists define the last 10,000 years, or our current epoch, as the Holocene (Bishop 2003). What has been described as the “Neolithic Revolution” also dates from 10,000 years ago (Wells 2007). Spurred by early developments in crop domestication in regions such as the Fertile Crescent (Wells 2007), Neolithic farmers began to move to and settle in new areas with their crops ten millennia ago (Vaughan et al. 2007). What was no doubt at first gradual and local ultimately became global. Human migrations and population expansions during the Holocene are mixing the previously isolated biotas of the world at an accelerating pace (Mooney and Cleland 2001). Organisms outside their native ranges bear many

---

G. Newcombe

Department of Forest Resources, and Center for Research on Invasive Species and Small Populations, University of Idaho, Moscow, ID 83844-1133, USA

e-mail: georgen@uidaho.edu

F.M. Dugan

USDA-ARS, Washington State University, Pullman, WA 99163-6402, USA

descriptors: non-native, nonindigenous, exotic, introduced, or alien. Non-native pathogens are additionally called “novel.” Some non-native organisms have proven invasive, and invasion biologists have begun to describe the latter part of our epoch as the Homogocene a term coined by Gordon Orians (Rosenzweig 2001a). This term invokes the global scope and increasing rate of anthropogenic, *biotic homogenization* that is defined as the “gradual replacement of native biotas by locally expanding non-natives” (Olden et al. 2004). The consequences of homogenization for biotic communities and ecosystem processes are the subject of a growing research effort; here we focus on fungal pathogens in the Homogocene.

Unsurprisingly, most of the literature of invasion biology focuses on plants and animals (Pyšek et al. 2006), leaving mycologically oriented ecologists to wonder about fungi. Crop pathogens are of course exceptional in this regard as they are often discussed in the phytopathological literature (Rossman 2009; Stukenbrock and McDonald 2008) and lists of such pathogens that are thought to be non-native are frequently compiled (Madden 2001). The most famous historical example is arguably the pseudo-fungus (oomycete) associated with the Irish potato famine, *Phytophthora infestans*. Both the host and pathogen probably originated from the Andes (Gómez-Alpizar et al. 2007), and their reunion in Ireland proved disastrous both for the crop and the people who depended on it. Other examples include black Sigatoka and yellow Sigatoka of banana (causal agents *Mycosphaerella musicola* and *M. fijiensis*, respectively). In these cases, the host is from Southeast Asia, and this may also be true for these fungi that were nevertheless first documented in Fiji; both diseases now constitute global epidemics on banana (Marín et al. 2003). Other instances from agriculture are concisely mentioned here and there in what follows.

However, this review emphasizes examples of plants from natural plant communities (i.e., nonagricultural settings). Chestnut blight and white pine blister rust (discussed below) are widely investigated, but we present many other instances much less familiar to the scientific public. We believe that a careful examination of the behavior of fungal phytopathogens in the Homogocene reveals ecologically significant patterns. These patterns should be of as much interest to invasion biologists and ecologists as they are to mycologists and plant pathologists, because fungi influence plants even while going unnoticed.

Voyaging peoples have likely always brought useful and favored plants and animals with them to be deliberately introduced to new lands that they encountered. Before Captain Cook landed in Hawaii in 1778, Polynesian seafarers had already discovered these remote, volcanic islands and introduced such plants as candlenut (*Aleurites moluccana*), ti (*Cordyline fruticosa*), taro (*Colocasia esculenta*), sweet potato (*Ipomoea batatas*), sugarcane (*Saccharum officinarum*), and perhaps two dozen other species (Carlquist 1980). Such early plant introductions were certainly not limited to Polynesia, or to plants brought with European colonists to the New World. Plant-hunting expeditions were probably initiated as early as 3,000 years before Columbus, as hieroglyphs appear to show that the Queen of Egypt sent out collectors of exotic plants for her gardens (Baskin 2003). Mycologists know that at least some endophytic and phytopathogenic fungi must have quietly accompanied these plant introductions (Palm 1999, 2001; Palm and Rossman 2003). But what can we say today about these co-introductions and their effects on Hawaiian

and other ecosystems around the world? Were those co-introduced endophytes so host-specific that we can be sure that they remained exclusive to their original hosts? If they jumped to other hosts, presumably related ones (Gilbert and Webb 2007), what ecological effects might they have had, and how can we distinguish them today from co-evolved interactions?

These questions go well beyond Hawaii, and include all fungi globally. Maritime explorations by western Europeans that began in the early fifteenth century (Love 2006) were initially restricted in scope, but they gradually became global and much more ambitious. Scientific travelers such as Alexander von Humboldt, Charles Darwin, and Alfred Russell Wallace began in the nineteenth century to discover how life's diversity was distributed around the world. At the same time, plant explorers of many nationalities were seeking to deliberately introduce desirable plants to their home countries (Reichard and White 2001). Crop plants had already been introduced almost everywhere that they would grow profitably; Columbus, for example, wasted no time in introducing one of the most important New World domesticates, maize, into Europe in 1493 (Rebourg et al. 2003); during the same year Columbus introduced orange trees of Asian origin to Hispaniola (Houghton 1978).

Ten thousand years ago, homogenization was undoubtedly not occurring at modern rates, although it had probably been initiated on local or regional scales. So, the Homogocene cannot be said to have begun with the Holocene. Instead, 1500 would appear to be a good year to choose for the beginning of the Homogocene. This date is also in agreement with the judgment of ecological, economic, and social historians, whose titles or subtitles accordingly include phraseology suggestive of worldwide movement of goods and peoples beginning at this time, e.g., "Accumulation on a World Scale," "Expansion of Europe," "Modern World-System," etc. (Amin 1974; Crosby 2004; Wallerstein 1974, 1980, 1989). Five hundred and nine years ago, the "Age of Discovery" was under way, and today, deliberate plant introductions are so common that the "majority of woody invasive plants in the United States were introduced for horticultural purposes – one study found that 82% of 235 woody plant species identified as colonizing outside of cultivation had been used in landscaping" (Reichard and White 2001). The "Homogocene" may not yet be a serious term in science but it does simply and directly evoke global commingling during the last half a millennium.

Plant-oriented invasion biologists in Europe already use 1500 to divide alien plants (Pyšek et al. 2004) into those that are called "archaeophytes" if introduced before 1500, and "neophytes" if introduced later. However, we hasten to make explicit what we have already hinted at: migration or purposeful import of plant materials well prior to 1500 probably made important contributions to homogenization on a regional, and sometimes even continental or oceanic, scale. In addition to the example of Polynesia above, expansion of Neolithic farming cultures such as the Arawak (from the upper Amazon and Orinoco basins to the West Indies), Bantu (from western to southern Africa), and Indo-European (from a still disputed location, perhaps Anatolia or the European steppes, but eventually throughout Europe and much of western and central Asia) moved plant materials considerable distances (Diamond and Bellwood 2003). Pronounced effects have been postulated for movement of plant pests and diseases in these distant times, e.g., the "honeymoon

hypothesis” of a comparatively pest- and disease-free agriculture in Neolithic Europe (Dark and Gent 2001), or the introduction of *Ascochyta* blight of chickpea, resulting in summer cropping systems in the Levant (Abbo et al. 2003). Literature on movement of plant pathogenic fungi from the Neolithic through classical antiquity has been summarized recently (Dugan 2008). Archaeobotanical or text-based analyses are particularly numerous for tracing the complex introduction of crops into medieval Europe (Behre 1992; Campbell 1988; Harvey 1984, 1992; Kroll 2005; Preston et al. 2004; Taavitsainen et al. 1998).

Introduced plants are not all equal ecologically. Introduced or alien plants can become naturalized if they survive and regularly reproduce outside of cultivation (Richardson et al. 2000b). Of course, only a small fraction of introduced plants become naturalized. For example, in Florida, of approximately 25,000 non-native or alien plant species, only 900 have become naturalized (Pimentel et al. 2005). A further winnowing occurs as only a small fraction of naturalized species become invasive, with invaders defined as species that have successfully spread away from sites of introduction (Richardson et al. 2000b). These successive winnowings characterize what is called the “tens rule” (Williamson and Fitter 1996), a rule of thumb that reflects the fact that relatively few aliens become invaders (Kolar and Lodge 2001). Plant and community ecologists are keenly interested in understanding this phenomenon.

In this chapter, we shall see how well concepts and definitions borrowed from invasion biology might apply to fungi, especially fungal pathogens of plants. Is there a “tens rule” for fungal pathogens, or are all alien fungal pathogens equally likely to attack evolutionarily naive plants or a host from which they had been separated? In describing the plants and pathogens that take part in “first encounters” as evolutionarily “naive” and “novel,” respectively, we are following the example of Parker and Gilbert (2004). If the “tens rule” does apply, do we have, or can we develop, hypotheses to predict which fungal pathogens will naturalize and which will become invaders? The threat of fungi as novel pathogens is a traditional topic for plant pathologists and mycologists (Rossman 2001). But, apart from the notorious example of chestnut blight, do novel pathogens generally act as “transformers” that “change the character, condition, form or nature of ecosystems over a substantial area” (Pyšek et al. 2004)? What are the roles of fungi as potential facilitators of plant invasions in the Holocene? Recognizing and predicting invasions are the central objectives of invasion biology (Kolar and Lodge 2001). But both objectives seem to be predicated on knowing the native, geographic ranges of the organisms in question, a problematic area for mycology.

## 1.2 Native Ranges of Fungi

In the eighteenth century, the French naturalist, Georges Buffon, had observed that different continents had different assemblages of macrobes (i.e., plants and animals) (Cox and Moore 2005). In the nineteenth century, Humboldt had



discovered the predictability of species–area relationships in that larger areas held more species (Rosenzweig 1995), but again this was known to apply only to macrobes. Spatial scaling and diversification of fungi were little studied until recently when species-area relationships of fungi were demonstrated to be similar to those of macrobes (Green et al. 2004). This was not a trivial finding because even today some microbiologists maintain the view that microbial eukaryotes have global ranges (Fenchel and Finlay 2004). The views of Beijerinck, that species of bacteria were cosmopolitan, or of Baas-Becking, that “everything is everywhere” (Fenchel and Finlay 2004), have also been challenged recently by application of the sequence-based phylogenetic species concept of fungi (Taylor et al. 2006).

Mycologists are now learning that most fungi do conform to Buffon’s Law and to spatial scaling rules for macrobes. However, it does not follow that it will be easy to determine the native ranges of those fungi that do conform, for reasons that will be discussed. And then there are undoubtedly fungi that do not conform. For example, some saprophytic hyphomycetes, such as common *Cladosporium* species, are associated with a very broad range of substrata. Such species do indeed seem to have cosmopolitan distributions as evidenced by their incorporation over long time periods into Arctic ice, alpine glaciers, and permafrost throughout the Northern Hemisphere (summarized in Dugan 2008).

Macrobiologists may be surprised to learn that the native ranges of fungi are largely unknown. Yet, how could it be otherwise? Today, 83% and 90% of vascular plants and vertebrates, respectively, are known to macrobiologists, whereas, at best, from 7% to perhaps 20% of the fungi are presently described (Cox and Moore 2005; Hawksworth 2001; Rossman 2009). Now when a new species of fungus is described, its current, geographic pattern of occurrence might suggest an original native range. Unfortunately, that pattern could also be the product of homogenization since 1500. In contrast, the native ranges of macrobes are largely known, not only because the species are largely known, but because their ranges were documented early in the Homogocene before homogenization had had large effects. Disputes do exist, but they appear minor in scope to a mycologist. For instance, Gayther Plummer proposed that the most mysterious of native trees of North America, *Franklinia alatomaha*, or the Franklin tree, was actually introduced from Asia a few decades before the Bartrams discovered a small grove in 1765 (Rowland 2006). Most botanists, however, disagree with Plummer (USDA n.d.). The native ranges of annual brome-grasses have more recently presented more serious challenges to botanists (Smith 1986), and other examples exist of course, but botanists have a set of criteria for dealing with problematic taxa: paleobotanical evidence of native status, records of their presence in their current range by early botanists, and current presence in natural habitats (Pyšek et al. 2004).

Mycologists face the unknown species problem, and the problem of the near total lack of knowledge of pre-Homogocene distributions. Mycologists were not on board the ships of the explorers and palaeomycology can hardly arbitrate disputes, as it is “in its infancy” (Stubblefield and Taylor 1988); others have even argued that the fungi lack “any significant fossil record” (Cain 1972). Even today fungi

are more intensively studied in managed habitats, as pathogens of agricultural crops, than in natural habitats where fungi provide ecosystem services on a massive scale. Last, but not least for a book on the molecular identification of fungi, “molecular diagnostic tools are only as good as the systematic underpinnings upon which these tools are based” (Rossman 2009), and upheavals in fungal systematics are common today.

What can we make of a new species such as *Cladosporium subtilissimum* that was described recently from material in Slovenia and the northwestern United States (Schubert et al. 2007)? It could have been cosmopolitan prior to the Holocene, but can we rule out the role of homogenization in producing its current distribution? Climate change can of course also cause range shifts (Parmesan 2006), but homogenization is more likely to be the source of the error that we are concerned with here: calling an invaded or naturalized range a native range or part of a native range. How can this error be avoided? And to what extent have previously isolated mycobiotas already been cryptically homogenized?

### 1.3 Pathogen Release

A roundabout but fruitful way to approach the latter question is through the pathogen release hypothesis, according to which alien plants are less regulated by pathogens than native plants (Keane and Crawley 2002). But first, if all fungi were everywhere, as Beijerinck, Baas-Becking, Fenchel, and Finlay have asserted is the case for other microbes (Fenchel and Finlay 2004), there would be no pathogen release for plants from plant pathogenic fungi. Plants would have the same set of fungal pathogens in both their native and invaded ranges. The environment (i.e., the host plant) would select.

Is pathogen release a real phenomenon? Using the USDA Fungus–Host Distributions database of the Systematic Mycology and Microbiology Laboratory, Mitchell and Power showed that for “473 plant species naturalized to the United States from Europe” there were 84% fewer rust, smut, and powdery mildew species infecting plants in their naturalized ranges than in their native ranges (Mitchell and Power 2003). The SMML database is by far the most extensive of its kind with “reports of fungi on plant hosts throughout the world that includes over 94,000 fungal species” (Rossman 2009). One could also cite specific examples of fungi that have been deliberately introduced for classical biocontrol of weedy plants that more directly confirm the pathogen release hypothesis for phytopathogenic fungi (Cullen et al. 1973), but Mitchell and Power’s paper was the first study to show the generality of this phenomenon. Another way of phrasing this is that if phytopathogenic fungi were everywhere, then pathogen introductions would not be a threat. To prove that this belief represents a completely false sense of security, one has to look no further than the chestnut blight fungus that transformed an ecosystem (Cox 1999; Liebhold et al. 1995; Rizzo and Garbelotto 2003).

Although plants may at first leave their fungal enemies behind when introduced outside their native ranges, in keeping with pathogen release, one can imagine that inadvertent introductions of those same enemies would slowly counter the pathogen release effect over time. These “pathogen reunions” do occur, and they are perhaps the best measure that we have of the rate of introduction of fungi (i.e., fungal homogenization) around the world. For example, when rust occurred on *Centaurea diffusa*, an invasive plant of Eurasian origin, for the first time in North America in 1989 (Mortensen et al. 1989) or for the first time in the United States in 1992 (Dugan and Carris 1992; Palm et al. 1992), these pathogen reunions ended more than 80 years of release from rust dating from 1907, the year that *C. diffusa* itself was introduced into North America (Maddox 1982). This rust, *Puccinia jaceae* var. *diffusae* of Eurasian origins (Savile 1970b), is easily distinguished from the only rust fungus, *Puccinia irrequiseta*, that occurs on the only North American species of *Centaurea*, *C. americana* (Savile 1970a).

In the case of tansy, or *Tanacetum vulgare*, plants were introduced and cultivated by English colonists in North America for culinary and medicinal purposes (Haughton 1978). Rust, common in its native range, was absent from this introduced range. Some 400 years after the introduction of tansy, *Puccinia tanacetii* was finally reunited with its host for the first time in the North American range of tansy (Newcombe 2003b).

*Cochliobolus carbonum* provides an example of serial pathogen reunions in that it must have followed the introduction of its host, *Zea mays*, around the world to the point where the fungus itself is now cosmopolitan. Some of the reunions were relatively recent. For instance, *C. carbonum* only reached Great Britain in 1972 (Jones and Baker 2007), which is presumably long after *Z. mays* was introduced there, as the plant was introduced into Europe in 1493 by Columbus (Rebourg et al. 2003). *C. carbonum* had reached Australia 6 years before it arrived in the U.K. (Farr et al. n.d.). Soybean rust, caused by *Phakopsora pachyrhizi* and *P. meibomiaae*, also took considerable time to be reunited with its agriculturally important host around the world (Rossman 2009).

It is not clear how lengthy periods of pathogen release might potentially be as many pathogen reunions have yet to occur. *Morus alba*, the white mulberry, was deliberately introduced from China in an attempt to establish a silk industry in the U.S. more than 400 years ago (Duncan and Duncan 1988). The tree has naturalized, and even become locally invasive in the U.S., but its rust fungi (i.e., species of *Cerotelium*, *Peridiopsisora*, *Phakopsora*, and *Kuehneola*) have remained in the native range of their host (Farr et al. n.d.). Powdery mildews, on the other hand, have reunited with introduced populations of white mulberry in western Europe and Central America, although not yet in North America (Farr et al. n.d.).

Similarly, St.-John’s-wort, *Hypericum perforatum*, was introduced into North America by Rosicrucian pilgrims in 1696 (Haughton 1978), and it has since become weedy and invasive across the entire continent (USDA n.d.). But more than 400 years later *Melampsora hypericorum* has yet to be reunited with *H. perforatum*,

as this rust fungus has only been recorded in St.-John's-wort's native range in Europe (Farr et al. n.d.). On the other hand, it was close to 2,000 years ago that the Romans introduced *H. perforatum* to the U.K. (Haughton 1978), where reunion with *M. hypericum* eventually did occur sometime before 1913 (Grove 1913). The "honeymoon hypothesis" of Dark and Gent (2001), mentioned above, posited that some reunions of grave consequence to European agriculture were postponed for centuries, but these reunions eventually took place as long distance movement of seeds became more routine in the late Iron Age and Roman times.

Plants native to North America were also introduced to Europe where some remain in a state of at least partial pathogen release. *Helianthus tuberosus*, the inappropriately named "Jerusalem artichoke," was brought to Europe from North America in the early 1600s (Hedrick 1950). Although *Puccinia helianthi* was then reunited with its host in western Europe nearly 400 years later, other rust fungi remain restricted to the native range (e.g., *Coleosporium helianthi*) (Farr et al. n.d.). A similar pattern of pathogen release is known for *Helianthus annuus*, the cultivated sunflower, also a native of North America that became widely cultivated around the world.

It is important to note that pathogen reunions may be confused with infection by morphologically similar fungi that are native to the naturalized range of an introduced plant. For instance, *Populus nigra* is Eurasian, but it has been widely planted in North America as cv. 'Italica,' the columnar Lombardy poplar. *Venturia* infection of *P. nigra* in North America could potentially represent pathogen reunion by a Eurasian *Venturia*, or host switching by a *Venturia* that is native to North American *Populus*. As it turns out, *Venturia populina*, a Eurasian fungus, was determined to be causing leaf and shoot blight of *P. nigra* (Newcombe 2003a), so this was a case of pathogen reunion. *Venturia inopina*, occurring on a North American species of *Populus*, *P. trichocarpa*, is morphologically similar to *V. populina*, but it has not switched to *P. nigra*. It was the specificities of these two species of *Venturia* for their respective hosts, expressed in a common environment, that actually led to discernment of subtle, but consistent, differences in morphology and in ITS sequences. In retrospect, *Venturia* blight of *P. nigra* in North America could easily have been misinterpreted as host switching, or simply as the product of a fungus with a broader host range and larger geographic range than either of these species of *Venturia* actually has.

In general, most of the introductions of alien or so-called "invasive" plant pathogens appear to be pathogen reunions. In a recent study of 1970–2004, among the introductions of non-native plant pathogens into the U.K., 85% were reunions on plants that were themselves introduced. Only 15% were first reports of pathogens on native, wild plants of the U.K., and not all of these were necessarily reports of alien pathogens (Jones and Baker 2007); some could have been native pathogens that had been overlooked because their hosts lacked economic importance. Pathogen reunions may be the best measure that we have of the rate of introduction of fungi, but what do they tell us about the native ranges of fungi, the primary question of this section?

## 1.4 Inferring Native Ranges of Fungi from Pathogen Release

It is tempting to think that fungi with restricted host ranges must be native where their hosts are native. *Camellia*, a genus of some 200 species, is endemic in eastern Asia, with its center of diversity in southern China (Ta and Bartholomew 1984). As *Ciborinia camelliae* is restricted to *Camellia*, its discovery on *C. japonica* in Great Britain in 1999 (Jones and Baker 2007) should ultimately be traced back to a native range in eastern Asia even though other parts of the world may have been stepping stones. If species of *Camellia* had never been introduced outside eastern Asia, the inference of sympatry for its host-restricted fungi would be unequivocal. Ornamental species of *Deutzia* provide such an example in that they are also endemic to Asia where seven taxa of rust fungi commonly infect them (Farr et al. n.d.). Unlike *C. camelliae*, records of rust on *Deutzia* outside the native range are absent even though *D. scabra* was introduced to the U.S. as early as 1822 (Rehder 1940).

Searches of the SMML Fungus–Host Distribution Database (Farr et al. n.d.) suggest restricted host and geographic ranges of fungi too numerous to comprehensively list here, but it is instructive to provide examples. Three species of *Pucciniastrum* occur only on Asian species of *Acer*, maple, and only in Asia. Rust occurs on the English oak, *Quercus robur*, in its native range but not in its introduced range in North America, even though *Uredinales* is well represented on North American *Quercus*. *Amelanchier alnifolia* supports 17 rust taxa in its native range in North America, but none in Europe where it has naturalized (Zerbe and Wirth 2006). Presence in the host’s native range and absence in its naturalized range allow for strong inference of the native range of a fungus (Table 1.1); presence in both of the host’s ranges is problematic only in the absence of historical records of absence of the fungus in one of them.

It is even more tempting to think that the combination of Fahrenholz’s rule and knowledge of the native ranges of plants can be used to further strengthen inferences of native ranges of fungi. Fahrenholz’s rule postulates that “parasites and their hosts speciate in synchrony” (Hafner and Nadler 1988). If host switching were not an issue, then native ranges of hosts should also be native ranges of their parasites. However, host switching is an issue (Jackson 2004).

Host switching is best exemplified by absence in the host’s native range and presence in its naturalized range. This requires some explanation, aided by the example of Eucalyptus rust (Grgurinovic et al. 2006). *Puccinia psidii* causes Eucalyptus rust but the first reports of this disease were not from the native range of species of *Eucalyptus* in Australia. Instead, this rust fungus was first reported on plantations of eucalypts grown in Brazil. Evidently, *P. psidii* had switched, or jumped, from species of Myrtaceae native to South America to introduced species of *Eucalyptus* that also belongs to Myrtaceae. Host switching can also be inferred from the early years of agriculture, e.g., for *formae speciales* of *Blumeria graminis*. Strict coevolution was apparently absent between this

**Table 1.1** Three categories of first encounters between evolutionarily naive plants and novel pathogens that depend on two factors: (1) which party to the encounter is alien, and (2) whether opportunities for encounters will be prolonged or brief. The category of the encounters in turn affects how susceptible and resistant outcomes of first encounters contribute, or not, to biotic resistance

Category	Time		Evolutionarily naive parties to first encounter		Biotic resistance (BR) of native biotic community versus alien plants or alien pathogens	
	Opportunities for encounters (prolonged by pathogen reunion)	Naive Plant	Novel Pathogen	Expected outcome of encounters, if contributing to BR	Examples of encounters (discussed in text)	
1	Extended, as naturalized, alien plants remain exposed to pathogens of native plants (no)	Alien	Native	Susceptible (S)	R ( <i>Prunus serotina</i> resistant to <i>Uredinales</i> in Europe). S (individuals of <i>Pinus sylvestris</i> susceptible to <i>Endocronarium harknessii</i> in North America)	
2	Extended, when alien pathogens are reunited with alien, naturalized plants (yes)	Native	Alien	Resistant (R)	R (6 of 7 taxa of <i>Malus</i> resistant to <i>Podosphaera leucotricha</i> in N. America). S ( <i>Malus angustifolia</i> , the seventh taxon, susceptible to <i>P. leucotricha</i> in N. America)	
3	Short (no)	Native	Alien	Resistant (R)	R (North American pines with <i>Cr</i> genes for resistance to <i>Cronartium ribicola</i> , an Asian fungus). S (individuals lacking these genes, in the same North American pines)	

powdery mildew and its grass family hosts in western Asia (Wyand and Brown 2003). Likewise, the barley scald pathogen, *Rhynchosporium secalis*, apparently evolved on other hosts outside the center of diversity for barley (Zaffarano et al. 2006).

## 1.5 Genetic Criteria for Native Range

Host range is sometimes not specific enough to even suggest a particular native range for a fungus. For example, *Venturia inaequalis*, the apple scab pathogen, affects all species of *Malus*, some of which are native to North America although most are Eurasian. Records of occurrence of *V. inaequalis* might be misleading in that the apple, first domesticated in central Asia, was introduced by early explorers everywhere that it would grow (Hedrick 1950). It is common in such cases to hypothesize that genetic variation will be greatest in the native range. Using this criterion, Gladieux et al. showed that *V. inaequalis* is likely native to the same area in Asia in which apple itself was domesticated (Gladieux et al. 2008). Similarly, an Asian origin of the dry rot fungus, *Serpula lacrymans*, has been inferred from a study of its genetic variation (Kausserud et al. 2007). Genetic variation also places the amphibian chytrid fungus, *Batrachochytrium dendrobatidis*, in a native range in South Africa (Weldon et al. 2004) from where it has spread to cause a pandemic. Interestingly, the highest genotypic diversity for the human dermatophyte, *Trichophyton rubrum*, is in Africa, where *Homo sapiens* itself evolved (Gräser et al. 2007).

Genetic diversity is not likely to be by itself an infallible criterion of native range, however. Plants with outcrossing mating systems are frequently as genetically diverse in their naturalized or invaded ranges as they are in their native ranges (Novak and Mack 2005). *Ambrosia artemisiifolia*, a North American plant, maintains high genetic diversity in its invaded range in France (Genton et al. 2005). Studies of *Bromus tectorum* have shown that even selfing plants may be as diverse in the invaded range, in North America, as in the native, Eurasian range, if the invasion involved multiple introductions (Novak and Mack 2005). A recent summary of 20 analyzes of genetic diversity in invasive plant populations showed that estimates of total genetic diversity vary from “none detected” to “high” (Ward et al. 2008).

Similar caveats may apply to sole use of a genetic criterion for determination of native ranges of fungi; genetic diversity of pine-associated *Sphaeropsis sapinea* is high in South Africa where the fungus must have been introduced from the northern hemisphere (Smith et al. 2000). Conversely, North American populations of *Entoleuca mammata* are genetically more variable than introduced populations in Europe (Kasanen et al. 2004). The oak wilt fungus, *Ceratocystis fagacearum*, is only known to occur in the middle and eastern United States, but its genetic homogeneity has led some researchers to hypothesize an exotic origin; the oak populations of Mexico or Central America have been suggested (Juzwik et al. 2008). An alternative hypothesis to explain low diversity is “the local genesis of a new and reproductively isolated strain or species” (Zambino and Harrington 2005).

However, low genetic variation can also characterize ancient and relictual species. For example, the Wollemi pine, *Wollemia nobilis*, is the only extant member of its genus, surviving only as a single, small population in a canyon in Australia (Peakall et al. 2003). No genetic variation whatsoever has been detected in *W. nobilis*. Genetic drift can reduce genetic variation in small and isolated populations of plants (Ouborg et al. 2006), and of organisms generally, but this explanation for genetic homogeneity of fungal species has not been widely considered.

## 1.6 Inferring Native Ranges of Pathogenic Fungi from Resistance

Given historical examples of extreme susceptibility of plants to novel pathogens (e.g., chestnut blight, and white pine blister rust), and the resistance of related plants elsewhere, it is tempting to think that host resistance can indicate native range of a pathogen. Many plant pathologists have followed this line of thinking. Their evolutionary explanation is that of selection for resistance in the presumptive native range, and the absence of such selection elsewhere. The host in the presumptive native range is thought to be evolutionarily adapted, whereas the host in the invaded range is said to be evolutionarily naive with respect to the novel pathogen. The Asian species of *Castanea* and *Pinus* were certainly more resistant to the chestnut blight and white pine blister rust fungi, respectively, than were North American species of *Castanea* and *Pinus*. With these examples as paradigm, researchers have tried to infer the native range or origin of many other pathogenic fungi that were unknown or poorly known prior to an epidemic.

The difficulties in doing so are twofold. First, the pathogen has to be present in the native range of a mostly resistant, putative host. Secondly, the resistance of the latter has to be adaptive and cannot be complete; the pathogen has to be able to survive and reproduce, so there must either be some susceptible individuals of an otherwise resistant species, or the adapted host could be tolerant (Roy and Kirchner 2000). Even then, it may prove surprisingly difficult to distinguish adaptive resistance, which is associated with ongoing selection, from exapted resistance (Newcombe 1998). Exaptations are characters that in a new evolutionary context can have selective value even if they resulted from selection for something else (Gould and Vrba 1982). For example, the resistance of *Populus maximowiczii*, a poplar native to eastern Asia, to species of *Venturia* and *Taphrina* on Canada's Vancouver Island could only have been construed as adaptive if there had been evidence that those fungi were native to eastern Asia. Needless to say, that would not have been a parsimonious interpretation (Newcombe 2005).

The evolution of plant-pollinator and plant-herbivore interactions may be linked through exaptations (Armbruster 1997). However, the linkages of exaptations for resistance to pathogens are unknown. One can only speculate that the function of genes in a poplar species in eastern Asia for resistance to Vancouver Island fungi



would presumably be related to defense of some kind. Adaptive resistance must also be distinguished from nonhost resistance that is predicted, but not explained, by phylogenetic signal (Gilbert and Webb 2007; Newcombe 2005).

Unfortunately, little attention has been paid to these distinctions when inferring native ranges of plant pathogens. In discussing root rot of Port Orford cedar caused by *Phytophthora lateralis*, the assumed relationship between resistance and origin of a pathogen was stated in this way: “*P. lateralis* was described in 1942. It is suspected to be of Eurasian origin because Asiatic species of *Chamaecyparis* resist it; resistance may have arisen through coevolution with the pathogen (Sinclair et al. 1987).” Eighteen years later however, Sinclair adopted a much more cautious position: “*P. lateralis*, origin unknown” (Sinclair and Lyon 2005). This caution in inferring native ranges of pathogens from the geographic distribution of resistance is warranted as the examples which follow will hopefully make clear. In the instance just discussed, the nature of resistance (i.e., adaptive versus exapted/nonhost) of Asian *Chamaecyparis* to *P. lateralis* remains unclear.

Dogwood anthracnose, for example, is also thought to be caused by a high-profile, alien pathogen, *Discula destructiva*. *Discula destructiva* has been regarded as an alien pathogen in North America (Redlin 1991), that has more recently appeared in the U.K. (Jones and Baker 2007), and in western Europe (Holdenrieder and Sieber 2007). Its appearances in the U.K. and Europe have been on *Cornus florida* that is native to North America. Susceptibility associated with severe damage and mortality in nature is only seen in the North American species, *C. florida* and *C. nuttallii* (Sinclair and Lyon 2005). Inferring the native range of *D. destructiva* from these observations, one would conclude that its origins were Eurasian. But, actually, resistance is not a helpful criterion because it characterizes at least some species of *Cornus* native to each one of the three continents where *D. destructiva* could be native: North America, Europe, and Asia (Holdenrieder and Sieber 2007; Sinclair and Lyon 2005). Although the native range of *D. destructiva* has been hypothesized on the basis of host resistance to specifically coincide with that of *Cornus kousa* in eastern Asia (Redlin 1991), the fungus has never been reported on *C. kousa* in its native range. Fourteen fungi have been recorded on *C. kousa* in eastern Asia (Farr et al. n.d.), but *D. destructiva* is not one of them. Interestingly, *C. florida*, grown as an introduced ornamental in Japan, has proven susceptible there to endemic *Pucciniastrum corni*, a number of taxa of Erysiphales, and a few other fungi, but *D. destructiva* has not been recorded on it. This evidence of absence in Japan is not definitive but it does suggest that resistance-based inferences of origin can be quite misleading.

Butternut canker provides another example. *Sirococcus clavignenti-juglandacearum* is thought to be an alien pathogen in North America that might have been introduced on seed of Asian species of *Juglans* such as *J. ailantifolia* (Ostry and Moore 2007). But the only record of *S. clavignenti-juglandacearum* on *J. ailantifolia* is from the U.S. (Ostry 1997), and records of this fungus from Asia are lacking on any host (Farr et al. n.d.). Nine fungal taxa have been recorded on *J. ailantifolia* in Asia, so the fungi of the putative, adaptive host are not completely unresearched (Farr et al. n.d.).

Records of eastern filbert blight, caused by *Anisogramma anomala*, are also restricted to North America (Farr et al. n.d.). But possibly because there were records of this disease from the late 1800s, *A. anomala* is not thought to be alien to North America (Sinclair and Lyon 2005). In fact, the native host of *A. anomala* is hypothesized to be *Corylus americana* (Coyne et al. 1998). But if resistance patterns were the sole criterion for native range, the resistance of some species of *Corylus* native to each of North America, Europe, and Asia would again be problematic (Coyne et al. 1998; Sinclair and Lyon 2005). Furthermore, if *A. anomala* is not present in Europe and Asia, and is truly native to North America, then the resistance of Eurasian species of *Corylus* must be of the exapted or nonhost variety rather than adaptive. As some individuals of the European hazelnut, *C. avellana*, are susceptible, nonhost resistance would seem to be ruled out. So, the dominant, “Gasaway” gene that is inherited from resistant individuals of the European hazelnut (Coyne et al. 1998) would be interpreted here as exapted.

Seiridium cankers of cypress are caused by three species of *Seiridium*. Relatively resistant species of *Calocedrus*, *Chamaecyparis*, *Cupressus*, *Juniperus*, *Taxodium*, *Thuja*, and *Thujopsis* are native to both Eurasia and North America (Sinclair and Lyon 2005). Once again, the lack of any discrete, geographic source of resistance known to be adaptive would thwart any attempt to pin any of the three species of *Seiridium* to any particular native range, at least using the sole criterion of resistance.

Fusiform rust, caused by *Cronartium quercuum* f.sp. *fusiforme*, is also instructive. The fusiform rust fungus is thought by many to be native to the region where it is currently most damaging: the southeastern U.S. However, after testing 45 species of *Pinus* for susceptibility/resistance to *C. quercuum* f.sp. *fusiforme*, an origin of *C. quercuum* f.sp. *fusiforme* in Central America was hypothesized (Tainter and Anderson 1993). This hypothesis was congruent with the relatively strong resistance of species of *Pinus* from Central America. However, equally strong resistance of Asian and Mediterranean species was evident in this study. To be consistent in applying the criterion of resistance, the authors would then have had to propose a native range for *C. quercuum* f.sp. *fusiforme* involving widely scattered, disjunct populations in Asia, Europe, and Central America, quite unlike that of any species of *Pinus* that hosts the fusiform rust fungus.

The oak wilt fungus, *Ceratocystis fagacearum*, of the middle and eastern United States, has already been mentioned. Its genetic homogeneity has led some researchers to hypothesize an exotic origin (Juzwik et al. 2008). But, it is impossible to infer the native range of *C. fagacearum* from host resistance alone for no other reason than that this subject remains seriously understudied in some 530 species of *Quercus* (Mabberley 2008). So, in addition to the challenging need to distinguish adaptive and exapted/nonhost resistance, undersampling issues can be formidable.

One might imagine that difficulties in determining native ranges of fungi from resistance are only encountered when alien pathogens are obscure and of little importance. But not only are the examples just cited important, but even fungi as important as the *Ophiostoma* species that have caused global pandemics of Dutch elm disease in the past century, remain of uncertain, geographic origin (Brasier and

Buck 2001). Surveys in China (Brasier 1990) and in the Himalayas (Brasier and Mehrotra 1995) were undertaken because resistant species of *Ulmus* are naturally distributed there. However, *O. ulmi* and *O. novo-ulmi* were not found in either surveyed region. Absence of the relevant pathogens implies that the resistance of Asian elms is exapted or nonhost, rather than adaptive. It should be noted that *Ophiostoma* species related to the Dutch elm fungus are one possible, and greatly debated, cause of the great mortality of elms in Europe during the Neolithic (summarily reviewed in Dugan 2008).

The above examples should not only encourage caution in inferring native ranges of fungi from resistance. They should also provoke questions about the threat of novel pathogens of plants. Even if adaptive resistance is obviously, by definition, absent in naive plants encountering novel pathogens, could not exapted or nonhost resistance protect them, and if so, at what frequency?

## 1.7 First Encounters Between Evolutionarily Naive Plants and Novel Pathogens

As previously mentioned, predicting outcomes of invasions is one of the central objectives of invasion biology (Kolar and Lodge 2001). With plants and animals, nonrelational hypotheses focus either on the relative invasiveness of potential invaders or the relative invasibility of potentially invaded communities (Heger and Trepl 2003). Relational hypotheses consider both. In all cases, however, it is considered essential to know the original, pre-Homogocene, geographic ranges of the organisms in question to develop and test hypotheses. To test the pathogen release hypothesis (Keane and Crawley 2002), for example, one needs to compare the enemies of a particular plant or animal in its native and invaded ranges. Novel weapons might aid a plant invader but only when wielded against species that are evolutionarily naive in the sense that they have never faced the weapons in question (Callaway and Ridenour 2004). Even Darwin's hypothesis, the first hypothesis of invasiveness (Rejmánek 1996), that invasive species are more likely from alien genera than from genera found in both ranges is, of course, predicated on knowing what those ranges are (Darwin 1859).

For fungal pathogens involved in pathogen reunions, prediction of outcomes is straightforward. Plant species "ABC," known to be susceptible in its native range to pathogen "abc," is likely to be susceptible everywhere else to "abc," provided that the environment is conducive to infection and disease expression. We might assume that the native range of "abc" is the same as that of "ABC," but all we really need to know for predictive purposes is that the latter is susceptible to the former somewhere else. But, pathogen reunions are not first encounters.

Outcomes of true, first encounters between naive plants and novel pathogens appear to be much more challenging to predict. Thus far, we have been operating under the assumption that for predictive purposes the native ranges of phytopathogenic

fungi must be known. However, the status of a first encounter may be ascertained merely by knowing that the two parties differ in their native ranges. In some cases, we may know their native ranges: the host switching that, for instance, occurred when naive *Eucalyptus* was introduced to South America and novel *Puccinia psidii* switched to *Eucalyptus* from native *Myrtaceae*. But, in the case of Dutch elm disease or dogwood anthracnose, as discussed above, neither the native ranges of the novel pathogens nor the identities of their adaptive hosts have ever been determined. Nevertheless, it is clear that these diseases do represent first encounters that must involve host switching.

Such encounters also represent the fungal component of what invasion biologists call “biotic resistance” (Parker and Gilbert 2004). Any and all organisms in a native community can provide biotic resistance to repel invaders. When pathogenic fungi switch from native plants to naive, alien plants, as in rust of *Eucalyptus*, they contribute to biotic resistance. This scenario represents one of three categories of first encounters between naive plants and novel pathogens that we emphasize here (Table 1.1): (1) alien plants versus native pathogens; (2) native plants versus alien pathogens involved in pathogen reunions, i.e., the majority of alien pathogens, which exist in their new, non-native environments on alien but naturalized hosts (Jones and Baker 2007); (3) native plants versus alien pathogens not involved in pathogen reunions. The first two categories allow pathogens considerable lag periods during which host switching may occur from their adaptive hosts. It is important to recall that alien organisms frequently become invasive only after considerable lag periods (Mack et al. 2000). The third category is distinct because it involves alien pathogens that must switch to the naive host immediately upon introduction because their adaptive host is absent.

The null hypothesis might be argued that these distinctions of three categories are unnecessary because evolutionarily naive plants will always be decimated by alien pathogens, particularly if the plants are closely related to the host of the alien pathogen in question. The examples of white pine blister rust and chestnut blight surely suggest as much. In the absence of selection for resistance, is not genetic susceptibility to pathogens of exotic congeners inevitable and complete? The short answer is no. Much of what we have already discussed implies this. The easiest way to expand that answer is to further discuss resistance to pathogens that were clearly alien, starting with the white pine blister rust fungus, *Cronartium ribicola*. The latter was a “Category 3” alien pathogen in North America (Table 1.1), but with an asterisk; it was introduced without an adaptive host but on a naive host, *Pinus strobus*, to which it had already switched outside North America (Kinloch 2003).

*Cronartium ribicola* is considered native to eastern Asia where its adaptive hosts are thought to include *Pinus sibirica*, *P. armandii*, *P. koraiensis*, *P. wallichiana*, and *P. pumila* (Kinloch 2003; Kinloch and Dupper 2002; Sinclair and Lyon 2005). The host range of *C. ribicola* spans the species of *Pinus* belonging to subgenus *Strobus* that includes sections *Quinquefoliae* and *Parrya* (Gernandt et al. 2005). These sections are especially speciose in North America and Asia, and less so in Europe where *P. cembra* and *P. peuce* are native. When the latter two European species, seven Asian species, and eight North American species were tested for

blister rust resistance in Europe, only *P. cembra* and the Asian species, *P. armandii* and *P. pumila* were completely resistant (Stephan 2001). Among the North American species, *P. aristata* of section *Parrya* was more resistant than the seven species representing section *Quinquefoliae*: *P. strobiformis*, *P. balfouriana*, *P. lambertiana*, *P. albicaulis*, *P. flexilis*, *P. monticola*, and *P. strobus*. When blister rust resistance was tested in North America, *P. strobiformis* was more resistant than other species of North American origin (Sniezko et al. 2008).

The point of emphasis here is the fact that none of the North American species encountering *C. ribicola* for the first time were completely susceptible because resistant individuals have been found in each (Stephan 2001; Sniezko et al. 2008). In fact, four species (i.e., *P. strobiformis*, *P. monticola*, *P. flexilis*, and *P. lambertiana*) have been shown in separate studies to possess major genes for resistance, albeit at low frequencies (Kinloch 1992; Kinloch and Dupper 2002; Kinloch et al. 1999, 2003). Although phenotypic evidence for these *Cr* genes was not detected in whitebark pine (*P. albicaulis*), Mexican white pine (*P. ayacahuite*), foxtail pine (*P. balfouriana*), and Great Basin bristlecone pine (*P. longaeva*), all of these species might possess such genes at low frequencies that would simply require additional sampling for their discovery (Kinloch and Dupper 2002). The authors conclude that although “blister rust traditionally is considered an exotic disease in North America, these results, typical of classic gene-for-gene interactions, suggest that genetic memory of similar encounters in past epochs has been retained in this pathosystem” (Kinloch and Dupper 2002).

Before considering examples of exapted resistance other than the *Cr* genes, the implications of gene-for-gene interactions require explanation. Disease resistance in plants is often tackled by using some conceptual dichotomy. Van Der Plank famously distinguished between vertical and horizontal resistance, for example (Van Der Plank 1975). Gene-for-gene interactions characterize Van Der Plank’s vertical resistance (Briggs and Johal 1994; Flor 1971; Thompson and Burdon 1992). Flor (1971) developed the gene-for-gene theory by performing correlated studies of the inheritance of both host resistance and pathogen virulence using cultivated flax and flax rust. Flor is typically quoted for defining these interactions in this way: “for each gene that conditions reaction in the host there is a corresponding gene that conditions pathogenicity in the pathogen.” Gene-for-gene interactions can also be inferred, somewhat less rigorously (Thompson and Burdon 1992), by proving that there are a number of distinct, major genes for resistance that allow pathogen isolates to be differentially distinguished as pathotypes. By this definition, gene-for-gene interactions do characterize white pine blister rust (Kinloch and Dupper 2002) and also poplar leaf rust that we shall discuss next as it also involves the sudden appearance of “genetic memory” in first encounters (Newcombe et al. 2001).

Recall that gene-for-gene interactions are thought to be the product of continuous coevolution (Person 1959, 1967). But both the poplar leaf rust pathosystem of the Pacific Northwestern region and the blister rust pathosystems of the white pines of North America appear to be the product of recent pathogen introductions, exapted resistance genes, and recent, adaptive changes in the pathogen populations.

Attempts to explain the *Cr* genes in terms of selection have been made; the highest frequencies of *Cr1* and *Cr2* are in the American Southwest near overlaps with pinyon pines of section *Parrya* and pinyon blister rust caused by an American native rust fungus, *Cronartium occidentale* (Kinloch and Dupper 2002). However, to positively demonstrate that *C. occidentale* was the selective agent that explains evolutionary retention of *Cr* genes, one would have to show that *Cr* genes protect species in section *Quinquefoliae* against *C. occidentale* (Kinloch and Dupper 2002). Otherwise, the retention of *Cr* genes in North American white pines appears paradoxical given the absence of selection (Kinloch and Dupper 2002).

In the case of poplar leaf rust also, resistance genes were revealed by pathogen introductions, raising again the question of their retention in the absence of selection. Complex pathogenic variation indicative of gene-for-gene interactions also appeared very quickly in this system, once the pathogen population had undergone hybridization to match that of its hybrid host (Newcombe et al. 2001). Some background is needed to explain current gene-for-gene interactions in poplar leaf rust in the Pacific Northwest of North America. *Populus trichocarpa*, the western black cottonwood, is native to the region, along with its coevolutionary rust, *Melampsora occidentalis*. When *P. trichocarpa* (T) from section *Tacamahaca* is crossed with *P. deltoides* (D), the eastern cottonwood, from section *Aigeiros*, fast-growing F<sub>1</sub> hybrid clones can be selected. These TxD hybrids have been the mainstay of commercial poplar plantations in the region for nearly three decades.

Initially TxD hybrids were rust-free. The resistance of *P. deltoides* to *M. occidentalis* (Newcombe et al. 2000), was transmitted to all TxD F<sub>1</sub> hybrids indicating that these *P. deltoides* parents are dominant homozygotes in this respect. In 1991, *Melampsora medusae*, the coevolutionary rust of *P. deltoides*, was found in the region. It quickly became apparent that some TxD F<sub>1</sub> hybrids were susceptible to *M. medusae*. Analysis of the inheritance of resistance to *M. medusae* in a TxD hybrid poplar pedigree demonstrated that the *Mmdl* gene for resistance was inherited from the *P. trichocarpa* parent (Newcombe et al. 1996). It is important to note that this gene had gone unnoticed in previous studies of the resistance of *P. trichocarpa* to *M. occidentalis*. The gene-for-gene explanation for the detection of *Mmdl* with *M. medusae* is that the latter evidently possesses the matching avirulence allele, unlike the coevolutionary rust, *M. occidentalis*. Both *P. trichocarpa* and *M. medusae* could even be fixed for this gene-for-gene pair as their interaction phenotype was always resistant, although testing was limited to nine individuals of the former and four isolates of the latter from the southeastern U.S. (Newcombe et al. 2000). Resistance to *M. medusae* was observed to segregate in the TxD F<sub>1</sub> because the *P. trichocarpa* parent was heterozygous at *Mmdl* (Newcombe et al. 1996).

Until 1995, there was no pathogenic variation in the rust population that simply consisted of *M. medusae*. F<sub>1</sub> clones either possessed the dominant *Mmdl* allele for resistance, or not. Emergence in the mid-1990s of the hybrid of *M. medusae* and *M. occidentalis*, *M. x columbiana*, changed this situation. Previously resistant TxD F<sub>1</sub> clones became susceptible. It rapidly became apparent that there was abundant pathogenic variation in the new hybrid population of *M. x columbiana*



(Newcombe et al. 2001). Just as *M. medusae* had allowed the *Mmd1* gene to be detected, new pathotypes of *M. × columbiana* were the means by which three new genes for resistance, *Mxc1*, *Mxc2*, and *Mxc3* were discovered. A new gene-for-gene pathosystem had appeared with exapted resistance genes and matching exapted avirulence genes. Resistance genes appear to be quite common in *Populus*, perhaps totaling in the hundreds (Tuskan et al. 2006). Hybridization has been hypothesized to be a stimulus for the evolution of invasiveness in plants (Ellstrand and Schierenbeck 2000), and it may be so also for pathogenic fungi (Brasier 2000).

Hybridization of both host and parasite that merged two separate pathosystems appears to account for the emergence of this gene-for-gene system. Reciprocal hybridization of the kind discussed here could have had an evolutionary history of repeated occurrence, as there is evidence of ancient hybridization between *Populus* sections *Tacamahaca* and *Aigeiros*, at least since the Miocene (Eckenwalder 1984). The genes for resistance and avirulence that now appear exapted could have been selected episodically in the past in recurring, hybrid zones. *Populus trichocarpa* and *P. deltoides* do currently hybridize naturally in parts of western North America (Eckenwalder 1996). The ancient introgression of *Pinus banksiana* into *Pinus contorta* in western North America (Critchfield 1985), has also left a signal in terms of resistance genes, that is still evident today (Wu et al. 1996).

But the evolutionary basis for genes for resistance to a Eurasian poplar rust fungus, *Melampsora larici-populina*, that are possessed by the North American species of *Populus*, *P. deltoides* (Cervera et al. 1996; Villar et al. 1996), is harder to imagine. We know that *M. larici-populina* was only introduced to North America in the early 1990s (Newcombe and Chastagner 1993), so the selective force or agent could not have been this fungus. The same question is raised by the above-mentioned “Gasaway” gene that confers resistance to a fungus found only in North America even though the gene itself is from a European plant, *Corylus avellana*.

We have already mentioned that species and hybrids of *Eucalyptus*, introduced to South America, encountered there for the first time a novel rust fungus, *Puccinia psidii*, which shifted to *Eucalyptus* from native *Myrtaceae* (Grgurinovic et al. 2006). Many hybrids of *E. grandis* of widespread use in Brazilian plantations have proven to be very susceptible to *P. psidii*; the latter also has a wide host range in the *Myrtaceae* having been reported on 11 genera and 31 species (Rayachhetry et al. 2001). Nevertheless, there are individuals of *E. grandis* that are resistant; one harbors a major gene for resistance to *P. psidii*, the *Ppr1* gene (Junghans et al. 2003). How can we explain in terms of selection an Australian gene for resistance to a South American fungus, without going back in time to the Late Paleocene/Early Eocene thermal maximum, 55 mya, when there is evidence for floristic exchange between South America and Australia that included *Myrtaceae* (Morley 2003)? Moreover, some evolutionarily naive species of *Myrtaceae* appear resistant, as species, to *P. psidii* (Rayachhetry et al. 2001). Another example is found in the native, North American range of western gall rust, caused by *Endocronartium harknessii*. Scots pine (*Pinus sylvestris*), one of the most widely grown of Eurasian pines in North America, possesses a recessive major gene for resistance

to western gall rust (Van der Kamp 1991). This gene may be common in Scots pine, at least in relation to the population of the western gall rust fungus in British Columbia where the study was performed. Two Asian hard pines, *Pinus thunbergii* and *P. densiflora*, are also resistant to western gall rust (Hopkin and Blenis 1989), although genetic analyses of their resistance have not been performed. From *Populus deltoides* of eastern North America were inherited QTL for resistance to a Pacific Northwestern population of *Mycosphaerella populicola* (Newcombe and Bradshaw 1996). Asian elms possess genes for resistance to black leaf spot caused by the North American population of *Stegophora ulmea* (Benet et al. 1995). A last example in this section is that of the *NRSA-1* gene for resistance to *Striga asiatica* that is found in a nonhost, *Tagetes erecta*, or marigold (Gowda et al. 1999).

## 1.8 A “Tens Rule” for Novel Pathogens

Exapted genes for resistance, such as the *Cr*, *Mmd*, *Gasaway*, and *Ppr* genes, have been found in resistant individuals in otherwise susceptible species. As such, exapted resistance differs from nonhost resistance in that the latter is presumed to be fixed in species outside the host range of the pathogen in question. But the evolutionary basis for this semantic distinction is unclear. In order to predict outcomes of first encounters between novel pathogens and evolutionarily naive plants, some estimate of frequency is needed, even though the evolutionary basis for the resistant outcome may be unknown. Examples suggest that the frequency of resistant outcomes is probably high. For example, an Asian maple species planted in North America is naive with respect to the “Category 1” pathogens (Table 1.1) of North American native maples. Would *Rhytisma americanum* infect an Asian maple grown in the U.S.? The answer appears to be no in that *R. americanum* is limited to North American natives, *Acer rubrum* and *A. saccharinum* (Farr et al. n.d.; Hudler and Jensen-Tracy 1998). Asian maples in North America are also apparently resistant to the “Category 2” *R. acerinum* that occurs on Norway maples, *A. platanoides*, in North America. The “Category 1” taxa of Mycosphaerellales that are quite common on North American maples in North America also do not appear to attack Asian maples at all (Farr et al. n.d.).

Would this pattern hold if we considered a North American plant that has been introduced into a different continent? Consider *Pinus contorta*, or the North American lodgepole pine, that is utilized quite commonly in forest plantations in northern Europe. Three decades ago, Roll-Hansen noted that *P. contorta* is “immune or nearly immune to all European rust fungi,” and “more resistant than *P. sylvestris* to *Phacidium infestans* and *Lophodermium pinastri*” (Roll-Hansen 1978). *Prunus serotina*, or black cherry, provides another good example because it is a North American tree that has become invasive in European forests (Chabrerie et al. 2008). Although eight rust taxa affect Eurasian species of *Prunus* in Europe, none of these “Category 1” pathogens infect *P. serotina* (Farr et al. n.d.). In other words, none provide biotic resistance against this plant invader. This is not because



*P. serotina* is immune to all rust fungi; in its native range in North America, four rust taxa affect it (Farr et al. n.d.). Similarly, the “Category 2” pear trellis rust, *Gymnosporangium fuscum*, has remained confined in North America to the Eurasian genus *Pyrus* as indigenous rosaceous genera are not known to be aecial hosts, and indigenous *Juniperus* populations are apparently resistant (Ziller 1974).

“Category 1” pathogens may switch immediately to long-term, alien plants, or they may eventually produce some virulent propagules that successfully infect the alien. Some past switches were likely not recorded immediately, so the importance of the extended opportunities of a lag period that is used to distinguish categories 2 and 3 (Table 1.1) is not yet clear. For example, *Hibiscus syriacus*, the popular rose-of-Sharon, was introduced to the Americas in the late sixteenth century from its native range in Asia. In the ensuing, 400 years in the Americas *H. syriacus* acquired five rust taxa that are not known to occur in its native range (Farr et al. n.d.). But the exact dates of switching are not known. Oddly, the one rust species that does occur on *H. syriacus* in India, *Uromyces heterogeneus*, has never been reunited with its host in its introduced range.

“Category 2” pathogens are alien pathogens that have been reunited with their adaptive hosts. The latter provide these pathogens with a lag period that they may need to successfully infect naive, native plants. *Podosphaera leucotricha* causes powdery mildew of apple, *Malus domestica*, that was domesticated in Eurasia. Like *Venturia inaequalis* that was shown to be Eurasian in origin (Gladieux et al. 2008) *P. leucotricha* appears to be Eurasian also. But, *P. leucotricha* has been reunited with apple in every part of North America in which apples are cultivated (Farr et al. n.d.) such that the seven *Malus* taxa native to North America have undoubtedly been exposed to its inoculum. Six of the seven appear to be resistant to *P. leucotricha* in that there are no records of this fungus on them. But one native species of *Malus* in the southeastern part of the U.S., *M. angustifolia*, has proven to be susceptible (Table 1.1). Phylogenetic signal does not appear to explain this susceptible exception as *M. angustifolia* is no more closely related to adaptive host species of *Malus* than resistant species of North America (e.g., *M. coronaria*) (Robinson et al. 2001). So, in this case, resistance appears to be exapted rather than nonhost. *P. leucotricha* has also been reunited in North America with Eurasian species of *Photinia*, *P. glabra* and *P. serratifolia*. Extended opportunities for first encounters with three species of *Photinia* native to North America have thus also been assured, but outcomes thus far apparently involve nothing but resistance as no records are known. This trend toward resistant outcomes of first encounters continues with two other genera of *Rosaceae*, *Crataegus* and *Spiraea*. *Crataegus* is especially speciose in North America (USDA n.d.) but there are no records of any of its taxa hosting *P. leucotricha*, even though *C. cuneata* in Japan does host *P. leucotricha*; perhaps this record is of a pathotype that has never been introduced into North America. In the case of *Spiraea*, *P. leucotricha* has been recorded on Japanese spiraea, *S. × bumalda*, in North America, but has not been recorded on 12 taxa of *Spiraea* native to North America (Farr et al. n.d.). If lag periods do not figure in the outcomes of first encounters, then the three categories of Table 1.1 could be collapsed.

Examples such as these have not been subjected to genetic analysis, but they do suggest a relatively high frequency of resistant outcomes when novel pathogens and naive plants meet. Furthermore, first encounters must be common as naturalized plants in the U.S. belong to 549 genera (USDA n.d.), of which 305, or 56%, are represented in the U.S. by both the naturalized species and native congeners. Other parts of the homogenized world are likely similar in affording many opportunities for plants to encounter “Category 1” or “Category 2” pathogens in particular.

A variant of the “tens rule” may thus apply to alien, plant pathogenic fungi in that only a fraction of all first encounters result in susceptible outcomes. This is analogous to the fact that only a fraction of all plant introductions result in plant invasions. This analogy, of course, does not imply that the same mechanism explains both phenomena. Improvements in our knowledge of the “tens rule” for novel fungal pathogens of plants will be built upon advances in the systematics and diagnostics of fungi that allow us to distinguish between pathogen reunions and first encounters. Improvements in our ability to predict which first encounters will result in relatively rare, but devastating, susceptible outcomes will come with a deeper understanding of the evolution and retention of genes for resistance.

## 1.9 Transformers

Susceptible outcomes of novel encounters can however be “transformative” if they change the “character, condition, form or nature of ecosystems over a substantial area” (Pyšek et al. 2004). The chestnut blight fungus, *Cryphonectria parasitica*, was clearly a “transformer” in the range of *Castanea dentata*, the American chestnut. The latter was an abundant species in eastern North America at the time of the introduction of the blight fungus (Paillet 2002). *C. dentata* is no longer a dominant, overstory tree species in those deciduous forests that are starting to be dominated by oak and hickory (McGormick and Platt 1980). Unfortunately, “we know very little concerning ecosystem response to the loss of chestnut” (Orwig 2002). Effects of blight on the food web were probably profound, but they were not studied except anecdotally. The American chestnut itself was not driven to extinction by blight, but chestnut-specific insects likely were (Opler 1978).

A particular class of transformer among novel fungal pathogens would be one which does cause the extinction of an evolutionarily naive plant species. However, examples of this are not known. Possibly, novel pathogens came closest with the above-mentioned *Franklinia alatamaha*. This tree species is not now extinct, but its only natural population was extirpated shortly after the Bartrams discovered it. Were it not for *ex situ* cultivation, *F. alatamaha* would now be extinct. Speculation about the causes of the loss of the single, naturally occurring population abounds (Rowland 2006), and that speculation includes the introduction of novel pathogens.

Small populations are notoriously susceptible to stochastic forces of extinction that might include pathogens (Rosenzweig 2001b), as we have also briefly

discussed. This is a serious concern for *Wollemia nobilis* that lacks genetic variation (Peakall et al. 2003); that finding might indicate that *W. nobilis* has lost through genetic drift genes for exapted resistance. Little is yet known however of the susceptibilities of *W. nobilis* other than that it has been shown to be susceptible to *Phytophthora cinnamomi* and to a species of *Botryosphaeria* (Bullock et al. 2000). Genetic uniformity certainly affected the magnitude of tree mortality caused by the Dutch elm fungus to *Ulmus procera*, the English elm, that turned out to be a 2,000-year-old Roman clone (Gil et al. 2004).

## 1.10 Deliberate Introductions of Fungi

Deliberate introductions of fungi have likely been uncommon. Some introductions have been made to control plant invaders (i.e., classical biological control) with pathogens with narrow host ranges such as rust fungi (Bruckart and Dowler 1986). Edible, cultivable mushrooms are certainly cultivated outside their native ranges (Arora 1986). Australian ectomycorrhizal fungi “were likely introduced with eucalypt seedlings brought into peninsular Spain before plant quarantine restrictions were observed” (Díez 2005), and this introduction may have been deliberate if the people transporting the seedlings knew of the dependence of eucalypts on these fungi. For the same purpose, ectomycorrhizal associates of pine seedlings were deliberately introduced into the southern hemisphere (Wingfield et al. 2001). Unfortunately, these introductions also inadvertently brought with them soil pathogens of some concern.

For example, *Rhizina undulata*, native to the northern hemisphere, now causes root disease in plantations of northern hemisphere conifers grown in plantations in southern Africa (Wingfield et al. 2001). *Armillaria mellea*, the root rot fungus, may also have entered South Africa in this way (Coetzee et al. 2001). Another nontarget effect of these ectomycorrhizal introductions, deliberate or inadvertent, has involved competition with native ectomycorrhizal fungi in the exotic tree plantations (Díez 2005). There are no doubt other examples, but in brief summary, deliberately introduced fungi represent just a tiny fraction of global, fungal diversity.

## 1.11 Inadvertent Co-Introductions of Fungi in Plants

Brasier highlights the dangers of inadvertent introductions of fungi by the modern plant trade (Brasier 2008). Even trees “up to 10 m tall with large root balls attached” are being moved from one country to another. Homogenization of previously isolated fungal communities above and belowground is thought to be inevitable if this trade persists. Not only can such shipments not be made safe, but the exotic plant itself contributes to changes in microbial community structure and function in

the soil (Kourtev et al. 2002). As belowground mutualisms (e.g., arbuscular mycorrhizal fungi) (Wolfe et al. 2005) affect aboveground mutualisms (e.g., pollinators) the effects of co-introductions of plants and fungi in the burgeoning plant trade may be profound even if researchers have not yet elucidated all of them. The movement of fungi in international food shipments can only be guessed at.

Pathogen release might seem almost miraculous when considered in the light of the ease with which pathogens have sometimes been moved with their host. For example, decades ago, Savile noted the inconspicuous adherence of teliospores of *Puccinia carthami* to seeds of safflower that when “planted in an isolated garden produced seedlings with pycnia” (Savile 1973). How then in 1876 did Henry Wickham succeed in moving 70,000 seeds of rubber-producing *Hevea brasiliensis* from its native Amazon basin to the Old World tropics via Kew without any propagules of the notorious blight fungus, *Microcyclus ulei* (Hobhouse 2003)? Wickham’s move and the subsequent pathogen release enjoyed by rubber plantations in Southeast Asia changed the course of the twentieth century. And if Henry Ford had understood pathogen release better, he might have thought twice about trying to duplicate the success of Asian rubber plantations by attempting to establish in the 1920s plantations in the Amazon that failed miserably due to blight.

Even if seeds and other plant propagules are surface-sterilized, endophytes are still moved around the world in the plant trade (Palm 1999). Endophytes can affect the ecology of plants in many ways, from tolerance to stressful conditions (Redman et al. 2002), through growth effects (Ernst et al. 2003), to plant community diversity (Clay and Holah 1999). We are still filling in the knowledge gaps of the functional roles in what has been called the “endophytic continuum” (Schulz and Boyle 2005). Endophytes in one invasive plant, *Centaurea stoebe* or spotted knapweed, were recently reported to be remarkably diverse in both the native and invaded ranges of the plant (Shipunov et al. 2008), with interesting effects on its ecology (Newcombe et al. 2009). Analyses of these communities suggested that both host switching and co-introduction “took place during the knapweed invasion.” It is possible that the origins of such fungi as the Dutch elm disease and dogwood anthracnose pathogens have not been determined because these fungi are only endophytic in the native ranges of their hosts.

## 1.12 Fungi as Facilitators of Plant Invasions

Release from phytopathogenic fungi is but one hypothesis to explain plant invasions (Mitchell and Power 2003). Recently, plant invasion biologists have taken a new interest in mycorrhization and other mutualisms (Richardson et al. 2000a), and in plant–soil feedback processes more generally (Ehrenfeld et al. 2005). Fungi in soil appear to be central to plant–soil feedbacks that promote alien plant invasions (Klironomos 2002). Alien plants may become abundant in part because they are

relatively resistant to fungal pathogens in soil that limit the abundance of many native plants (Klironomos 2002). Interpreted in light of the foregoing discussion of a “tens rule” for novel plant pathogens this would again indicate that first encounters below ground of novel pathogens and naive plants may more often than not involve incompatibility or resistance, just as aboveground encounters do. This point is reinforced by a meta-analysis of biotic resistance that revealed that native communities are defended against plant invaders by resident competitors and herbivores, but not by soil fungi (Levine et al. 2004).

In other words, an improved understanding of the outcomes of first encounters between novel pathogens and naive plants can potentially contribute simultaneously to questions that have been treated separately by different disciplines. On the one hand, mycologists and plant pathologists have had a traditional interest in predicting the outcome of introductions of novel plant pathogens. On the other, plant ecologists and invasion biologists have been trying to understand the mechanism of plant invasions. When the fungal pathogens in a plant community are native (i.e., Category 1 of Table 1.1), they fail to contribute to biotic resistance to plant invasions insofar as they fail to cause disease of alien plants, as summarized by Levine. This result is consistent with examples in categories 2 and 3 where resistant outcomes again prevail.

### 1.13 Conclusions

Ideally, on the eve of the Homogocene in 1499, trained scientists around the globe would have already described all species of life. A pre-Homogocene “Encyclopedia of Life” (Wilson 2003) would have provided the baseline from “Day 1” for subsequent tracking of every human-aided introduction of an alien that followed. Knowing the outcomes of every introduction of an alien species during the past 500 years, we might well be further along in our attempt to understand why some organisms are invasive and why most are not. Unfortunately, 1500 predates the development of Linnean taxonomy by 253 years (Linnaeus 1753), Christiaan H. Persoon’s *Synopsis Methodica Fungorum* by 301 years, and Elias Magnus Fries’ first volume of *Systema Fungorum* by 321 years.

Falling far short of the ideal, we instead find ourselves drawing inferences from patterns of pathogen release, and scattered studies of resistance relative to first encounters of plants and pathogens. Fortunately, for inferences from pathogen release, the SMML Fungus–Host Distribution Database and other databases of records of fungi on plants have proven invaluable. Homogenization itself has created opportunities for discoveries that otherwise might not have been made. Finally, the merging of the study of novel pathogens of plants with the general framework and terminology of invasion biology is bound to be helpful to all students of this global experiment of the last 500 years.

## References

- Abbo S, Shtienberg D, Lichtenzveig J, Lev-Yadun S, Gopher A (2003) The chickpea, summer cropping, and a new model for pulse domestication in the ancient near east. *Quart Rev Biol* 78:435–448
- Amin S (1974) *Accumulation on a world scale*. Monthly Review Press, New York
- Armbruster WS (1997) Exaptations link evolution of plant-herbivore and plant-pollinator interactions: a phylogenetic inquiry. *Ecology* 78:1661–1672
- Arora D (1986) *Mushrooms demystified*, 2nd edn. Ten Speed Press, Berkeley, CA
- Baskin Y (2003) *A plague of rats and rubbervines*. Island Press, Washington, D.C
- Behre KE (1992) The history of rye cultivation in Europe. *Veg Hist Archaeobot* 1:141–156
- Benet H, Guries RP, Boury S, Smalley EB (1995) Identification of RAPD markers linked to a black leaf spot resistance gene in Chinese elm. *Theor Appl Genet* 90:1068–1073
- Bishop EM (2003) *In search of ancient Oregon: a geological and natural history*. Timber Press, Inc., Portland
- Brasier C (2000) The rise of the hybrid fungi. *Nature* 405:134–135
- Brasier CM (1990) China and the origins of Dutch elm disease: an appraisal. *Plant Pathol* 39:5–16
- Brasier CM (2008) The biosecurity threat to the UK and global environment from international trade in plants. *Plant Pathol* 57:792–808
- Brasier CM, Buck KW (2001) Rapid evolutionary changes in a globally invading fungal pathogen (Dutch elm disease). *Biol Invasions* 3:223–233
- Brasier CM, Mehrotra M (1995) *Ophiostoma himal-ulmi* sp. nov., a new species of Dutch elm disease fungus endemic to the Himalayas. *Mycol Res* 99:205–215
- Briggs SP, Johal GS (1994) Genetic patterns of plant host-parasite interactions. *Trends Genet* 10:12–16
- Bruckart WL, Dowler WM (1986) Evaluation of exotic rust fungi in the United States for classical biological control of weeds. *Weed Sci* 34:11–14
- Bullock S, Summerell BA, Gunn LV (2000) Pathogenicity of five fungi to the Wollemi pine, *Wollemia nobilis*. *Australas Plant Pathol* 29:211–214
- Cain RF (1972) Evolution of the fungi. *Mycologia* 64:1–14
- Callaway R, Ridenour WM (2004) Novel weapons: invasive success and the evolution of increased competitive ability. *Front Ecol Environ* 2:436–443
- Campbell BMS (1988) The diffusion of vetches in medieval England. *Econ Hist Rev* 41:193–208
- Carlquist S (1980) *Hawaii: a natural history*, 2nd edn. Pacific Tropical Botanical Garden, Lawai, Kaua'i
- Cervera MT et al (1996) Identification of AFLP molecular markers for resistance against *Melampsora larici-populina* in *Populus*. *Theor Appl Genet* 93:733–737
- Chabrierie O, Verheyen K, Saguez R, Decocq G (2008) Disentangling relationships between habitat conditions, disturbance history, plant diversity, and American black cherry (*Prunus serotina* Ehrh.) invasion in a European temperate forest. *Divers Distrib* 14:204–212
- Clay K, Holah J (1999) Fungal endophyte symbiosis and plant diversity in successional fields. *Science* 285:1742–1744
- Coetzee M, Wingfield BD, Harrington TC, Steimel J, Coutinho TA, Wingfield MJ (2001) The root rot fungus *Armillaria mellea* introduced into South Africa by early Dutch settlers. *Mol Ecol* 10:387–396
- Cox CB, Moore PD (2005) *Biogeography – an ecological and evolutionary approach*, 7th edn. Blackwell, Oxford, U.K
- Cox GW (1999) *Alien species in North America and Hawaii*. Island Press, Washington, D.C
- Coyne CJ, Mehlenbacher SA, Smith DC (1998) Sources of resistance to eastern filbert blight in hazelnut. *J Am Soc Hort Sci* 123:253–257
- Critchfield WB (1985) The late Quaternary history of lodgepole and jack pines. *Can J Forest Res* 15:749–772

- Crosby AW (2004) *Ecological Imperialism: the biological expansion of Europe, 900–1900*. Cambridge University Press, Cambridge, UK
- Cullen JM, Kable PF, Catt M (1973) Epidemic spread of a rust imported for biological control. *Nature* 244:462–464
- Dark P, Gent H (2001) Pests and diseases of prehistoric crops: a yield “honeymoon” for early grain crops in Europe. *Oxford J Archaeol* 20:59–78
- Darwin C (1859) *On the origin of species*. Murray, London
- Diamond J, Bellwood P (2003) Farmers and their languages: the first expansions. *Science* 300:597–603
- Díez J (2005) Invasion biology of Australian ectomycorrhizal fungi introduced with eucalypt plantations into the Iberian Peninsula. *Biol Invasions* 7:3–15
- Dugan F (2008) *Fungi in the ancient World: how mushrooms, mildews, molds and yeast shaped the early civilizations of Europe, the Mediterranean, and the near east*. APS Press, St. Paul, MN
- Dugan FM, Carris LM (1992) *Puccinia jaceae* var. *diffusa* and *P. acroptili* on knapweeds in Washington. *Plant Dis* 76:972
- Duncan WH, Duncan MB (1988) *Trees of the Southeastern United States*. University of Georgia Press, Athens, Georgia
- Eckenwalder JE (1984) Natural intersectional hybridization between North American species of *Populus* (Salicaceae) in sections *Aigeiros* and *Tacamahaca*. III. Paleobotany and evolution. *Can J Bot* 62:336–342
- Eckenwalder JE (1996) Systematics and evolution of *Populus*. Part I, Chap. 1. In: Stettler RF, Bradshaw HD Jr, Heilman PE, Hinckley TM (eds) *Biology of Populus and its implications for management and conservation*. NRC Research Press, National Research Council of Canada, Ottawa, ON, pp 7–32
- Ehrensfield JG, Ravit B, Elgersma K (2005) Feedback in the plant-soil system. *Annu Rev Environ Resour* 30:75–115
- Ellstrand NC, Schierenbeck K (2000) Hybridization as a stimulus for the evolution of invasiveness in plants. *PNAS* 97:7043–7050
- Ernst M, Mendgen KW, Wirsal SGR (2003) Endophytic fungal mutualists: seed-borne *Stagonospora* spp. enhance reed biomass production in axenic microcosms. *Mol Plant-Microbe Interact* 16:580–587
- Farr DF, Rossman AY, Palm ME, McCray EB (n.d.) *Fungal Databases*. Systematic Mycology and Microbiology, USDA, ARS <http://nt.ars-grin.gov/fungaldatabases/>
- Fenichel T, Finlay BJ (2004) The ubiquity of small species: patterns of local and global diversity. *Bioscience* 54:777–784
- Flor HH (1971) Current status of the gene-for-gene concept. *Annu Rev Phytopathol* 9:275–296
- Genton BJ, Shykoff JA, Giraud T (2005) High genetic diversity in French invasive populations of common ragweed, *Ambrosia artemisiifolia*, as a result of multiple sources of introduction. *Mol Ecol* 14:4275–4285
- Gernandt DS, Geada López GG, Ortiz García S, Liston A (2005) Phylogeny and classification of *Pinus*. *Taxon* 54:29–42
- Gil L, Fuentes-Utrilla P, Soto A, Cervera MT, Collada C (2004) English elm is a 2, 000-year-old Roman clone. *Nature* 431:1053
- Gilbert GS, Webb CO (2007) Phylogenetic signal in plant pathogen-host range. *Proc Natl Acad Sci* 104:4979–4983
- Gladieux P, Zhang X-G, Afoufa-Bastien D, Valdebenito Sanhueza R-M, Sbaghi M, Le Cam B (2008) On the origin and spread of the scab disease of apple: out of central Asia. *PLoS ONE* 3:1–14
- Gómez-Alpizar L, Carbone I, Ristaino JB (2007) An Andean origin of *Phytophthora infestans* inferred from mitochondrial and nuclear gene genealogies. *PNAS* 104:3306–3311
- Gould SJ, Vrba ES (1982) Exaptation – a missing term in the science of form. *Paleobiology* 8:4–15
- Gowda BS, Riopel JL, Timko MP (1999) NRSA-1: a resistance gene homolog expressed in roots of non-host plants following parasitism by *Striga asiatica* (witchweed). *Plant J* 20:217–230

- Gräser Y, Fröhlich J, Presber W, De Hoog S (2007) Microsatellite markers reveal geographic population differentiation in *Trichophyton rubrum*. *J Med Microbiol* 56:1058–1065
- Green JL et al (2004) Spatial scaling of microbial eukaryote diversity. *Nature* 432:747–750
- Grgurinovic CA, Walsh D, Macbeth F (2006) Eucalyptus rust caused by *Puccinia psidii* and the threat it poses to Australia. *EPPO Bull* 36:486–489
- Grove WB (1913) *The British rust fungi (Uredinales): their biology and classification*. Cambridge University Press, Cambridge
- Hafner MS, Nadler SA (1988) Phylogenetic trees support the coevolution of parasites and their hosts. *Nature* 332:258–259
- Harvey JH (1984) Vegetables in the middle ages. *Garden Hist* 12:89–99
- Harvey JH (1992) Garden plants of Moorish Spain: a fresh look. *Garden History* 20:71–82
- Haughton CS (1978) *Green immigrants: the Plants that Transformed America*. Harcourt Brace Jovanovich, New York
- Hawksworth DL (2001) The magnitude of fungal diversity: the 1.5 million species estimate revisited. *Mycol Res* 105:1422–1432
- Hedrick UP (1950) *A history of horticulture in America to 1860*. Oxford University Press, New York, NY
- Heger T, Trepl L (2003) Predicting biological invasions. *Biol Invasions* 5:313–321
- Hobhouse H (2003) *Seeds of wealth*. Shoemaker & Hoard, Washington, D.C
- Holdenrieder O, Sieber TN (2007) First record of *Discula destructiva* in Switzerland and preliminary inoculation experiments on native European *Cornus* species. In: Evans H, Oszako T (eds) *Alien invasive species and International trade*. Forest Research Institute, Warsaw, Poland, pp 51–56
- Hopkin AA, Blenis PV (1989) Resistant responses in juvenile seedlings of *Pinus densiflora* (Japanese red pine) inoculated with *Endocronartium harknessii*. *Can J Bot* 67:3545–3552
- Hudler GW, Jensen-Tracy S (1998) *Rhytisma americanum* sp. nov.: a previously undescribed species of *Rhytisma* on maples (*Acer* spp.). *Mycotaxon* 68:405–416
- Jackson AP (2004) A reconciliation analysis of host switching in plant-fungal symbioses. *Evolution* 58:1909–1923
- Jones DR, Baker RHA (2007) Introductions of non-native plant pathogens into Great Britain, 1970–2004. *Plant Pathol* 56:891–910
- Junghans DT, Alfenas AC, Brommonschenkel SH, Oda S, Mello EJ, Grattapaglia D (2003) Resistance to rust (*Puccinia psidii* Winter) in *Eucalyptus*: mode of inheritance and mapping of a major gene with RAPD markers. *Theor Appl Genet* 108:175–180
- Juzwik J, Harrington TC, MacDonald WL, Appel DN (2008) The origin of *Ceratocystis fagacearum*, the oak wilt fungus. *Annu Rev Phytopathol* 46:13–26
- Kasanen R, Hantula J, Ostry ME, Pinon J, Kurkela T (2004) North American populations of *Entoleuca mammata* are genetically more variable than populations in Europe. *Mycol Res* 108:766–774
- Kausserud H et al (2007) Asian origin and rapid global spread of the destructive dry rot fungus *Serpula lacrymans*. *Mol Ecol* 16:3350–3360
- Keane RM, Crawley MJ (2002) Exotic plant invasions and the enemy release hypothesis. *Trends Ecol Evol* 17:164–170
- Kinloch BB (1992) Distribution and frequency of a gene for resistance to white pine blister rust in natural populations of sugar pine. *Can J Bot* 70:1319–1323
- Kinloch BB (2003) White pine blister rust in North America: past and prognosis. *Phytopathology* 93:1044–1047
- Kinloch BB, Dupper GE (2002) Genetic specificity in the white pine-blister rust pathosystem. *Phytopathology* 92:278–280
- Kinloch BB, Sniezko RA, Barnes GD, Greathouse TE (1999) A major gene for resistance to white pine blister rust in western white pine from the western Cascade Range. *Phytopathology* 89:861–867
- Kinloch BB, Sniezko RA, Dupper GE (2003) Origin and distribution of *Cr2*, a gene for resistance to white pine blister rust in natural populations of western white pine. *Phytopathology* 93:691–694



- Klironomos JN (2002) Feedback with soil biota contributes to plant rarity and invasiveness in communities. *Nature* 417:67–70
- Kolar CS, Lodge DM (2001) Progress in invasion biology: predicting invaders. *Trends Ecol Evol* 16:199–204
- Kourtev PS, Ehrenfeld JG, Haggblom M (2002) Exotic plant species alter the microbial community structure and function in the soil. *Ecology* 83:3152–3166
- Kroll H (2005) Literature on archaeological remains of cultivated plants 1981–2004. In. [www.archaeobotany.de/database.html](http://www.archaeobotany.de/database.html)
- Levine JM, Adler PB, Yelenik SG (2004) A meta-analysis of biotic resistance to exotic plant invasions. *Ecol Lett* 7:975–989
- Liebholt AM, MacDonald WL, Bergdahl D, Mastro VC (1995) Invasion by exotic forest pests: a threat to forest ecosystems. *Forest Sci Monograph* 30:1–57
- Linnaeus C (1753) *Species plantarum*. Laurentius Salvius, Sweden
- Love RS (2006) *Maritime exploration in the age of discovery, 1415–1800* Greenwood Press
- Mabberley DJ (2008) *Mabberley's plant book*, 3rd edn. Cambridge University Press, New York
- Mack RN, Simberloff D, Lonsdale WM, Evans H, Clout M, Bazzaz FA (2000) Biotic invasions: causes, epidemiology, global consequences, and control. *Ecol Appl* 10:689–710
- Madden LV (2001) What are the nonindigenous plant pathogens that threaten US crops and forests? APSnet Feature Story: <http://www.apsnet.org/online/feature/exotic>
- Maddox DM (1982) Biological control of diffuse knapweed (*Centaurea diffusa*) and spotted knapweed (*C. maculosa*). *Weed Sci* 30:76–82
- Marín DH, Romero RA, Guzmán M, Sutton TB (2003) Black sigatoka: an increasing threat to banana cultivation. *Plant Dis* 87:208–222
- McGormick JF, Platt RB (1980) Recovery of an Appalachian forest following the chestnut blight or Catherine Keever – you were right. *Am Midl Nat* 104:264–273
- Mitchell CE, Power AG (2003) Release of invasive plants from fungal and viral pathogens. *Nature* 421:625–627
- Mooney HA, Cleland EE (2001) The evolutionary impact of invasive species. *Proceedings of the National Academy of Sciences* 98:5446–5451
- Morley RJ (2003) Interplate dispersal paths for megathermal angiosperms. *Perspect Plant Ecol Evol Syst* 6:5–20
- Mortensen K, Harris P, Makowski RMD (1989) First occurrence of *Puccinia jaceae* var. *diffusae* in North America on diffuse knapweed (*Centaurea diffusa*). *Can J Plant Pathol* 11:322–324
- Newcombe G (1998) A review of exapted resistance to diseases of *Populus*. *Eur J Forest Pathol* 28:209–216
- Newcombe G (2003a) Native *Venturia inopina* sp. nov., specific to *Populus trichocarpa* and its hybrids. *Mycol Res* 107:108–116
- Newcombe G (2003b) *Puccinia tanacetii* – specialist or generalist. *Mycol Res* 107:797–802
- Newcombe G (2005) Genes for parasite-specific, nonhost resistance in *Populus*. *Phytopathology* 95:779–783
- Newcombe G, Bradshaw HD Jr (1996) Quantitative trait loci conferring resistance in hybrid poplar to *Septoria populicola*, the cause of leaf spot. *Can J For Res* 26:1943–1950
- Newcombe G, Bradshaw HD Jr, Chastagner GA, Stettler RF (1996) A major gene for resistance to *Melampsora medusae* f. sp. *deltoidae* in a hybrid poplar pedigree. *Phytopathology* 86:87–94
- Newcombe G, Chastagner GA (1993) First report of the Eurasian poplar leaf rust fungus, *Melampsora laricici-populina*, in North America. *Plant Dis* 77:532–535
- Newcombe G et al (2009) Endophytes influence protection and growth of an invasive plant. *Commun Integr Biol* 2:1–3
- Newcombe G, Stirling B, Bradshaw HD Jr (2001) Abundant pathogenic variation in the new hybrid rust *Melampsora x columbiana* on hybrid poplar. *Phytopathology* 91:981–985
- Newcombe G, Stirling B, McDonald S, Bradshaw HD (2000) *Melampsora x columbiana*, a natural hybrid of *M. medusae* and *M. occidentalis*. *Mycol Res* 104:261–274

- Novak SJ, Mack RN (2005) Genetic bottlenecks in alien plant species. In: Sax DF, Stachowicz JJ, Gaines SD (eds) *Species invasions: insights into ecology, evolution, and biogeography*. Sinauer Sunderland, Massachusetts, pp 201–228
- Olden JD, Poff NL, Douglas MR, Douglas ME, Fausch KD (2004) Ecological and evolutionary consequences of biotic homogenization. *Trends Ecol Evol* 19:18–24
- Opler PA (1978) Insects of American chestnut: possible importance and conservation concerns. In: McDonald J (ed) *The American chestnut symposium*. West Virginia University Press, Morgantown, West Virginia
- Orwig DA (2002) Ecosystem to regional impacts of introduced pests and pathogens: historical context, questions and issues. *J Biogeogr* 29:1471–1474
- Ostry ME (1997) *Sirococcus clavigignenti-juglandacearum* on heartnut (*Juglans ailantifolia* var. *cordiformis*). *Plant Dis* 81:1461
- Ostry ME, Moore M (2007) Natural and experimental host range of *Sirococcus clavigignenti-juglandacearum*. *Plant Dis* 91:581–584
- Ouborg NJ, Vergeer P, Mix C (2006) The rough edges of the conservation genetics paradigm for plants. *J Ecol* 94:1233–1248
- Paillet FL (2002) Chestnut: history and ecology of a transformed species. *J Biogeogr* 29:1517–1530
- Palm ME (1999) Mycology and world trade: a view from the front line. *Mycologia* 91:1–12
- Palm ME (2001) Systematics and the impact of invasive fungi on agriculture in the United States. *Bioscience* 51:141–147
- Palm ME, Richard RD, Parker P (1992) First report of *Puccinia jaceae* var. *diffusa* on diffuse knapweed in the United States. *Plant Dis* 76:972
- Palm ME, Rossman AY (2003) Invasion pathways of terrestrial plant-inhabiting fungi. In: Ruiz GM, Carlton JT (eds) *Invasive species – vectors and management strategies*. Island Press, Washington, D.C, p 518
- Parker IM, Gilbert GS (2004) The evolutionary ecology of novel plant-pathogen interactions. *Annu Rev Ecol Evol Syst* 35:675–700
- Parmesan C (2006) Ecological and evolutionary responses to recent climate change. *Annu Rev Ecol Evol Syst* 37:637–669
- Peakall R, Ebert D, Scott L, Meagher P, Offord C (2003) Comparative genetic study confirms exceptionally low genetic variation in the ancient and endangered relictual conifer, *Wollemia nobilis* (*Araucariaceae*). *Mol Ecol* 12:2331–2343
- Person C (1959) Gene-for-gene relationships in host: parasite systems. *Can J Bot* 37:1101–1130
- Person C (1967) Genetic aspects of parasitism. *Can J Bot* 45:1193–1204
- Pimentel D, Zuniga R, Morrison D (2005) Update on the environmental and economic costs associated with alien-invasive species in the United States. *Ecol Econ* 52:273–288
- Preston CD, Pearman D, Hall A (2004) Archaeophytes in Britain. *Bot J Linn Soc* 145:257–294
- Pyšek P, Richardson DM, Jarošík V (2006) Who cites who in the invasion zoo: insights from an analysis of the most highly cited papers in invasion ecology. *Preslia* 78:437–468
- Pyšek P, Richardson DM, Rejmánek M, Webster GL, Williamson M, Kirschner J (2004) Alien plants in checklists and floras: towards better communication between taxonomists and ecologists. *Taxon* 53:131–143
- Raychhetry MB, Van TK, Center TD, Elliott ML (2001) Host range of *Puccinia psidii*, a potential biological control agent of *Melaleuca quinquenervia* in Florida. *Biol Control* 22:38–45
- Rebourg C, Chastanet M, Gousenard B, Welcker C, Dubreuil P, Charcosset A (2003) Maize introduction into Europe: the history reviewed in the light of molecular data. *Theor Appl Genet* 106:895–903
- Redlin SC (1991) *Discula destructiva* sp. nov., cause of dogwood anthracnose. *Mycologia* 83:633–642
- Redman RS, Seehan KB, Stout RG, Rodriguez RJ, Henson JM (2002) Thermotolerance generated by plant/fungal symbiosis. *Science* 298:1581
- Rehder A (1940) *Manual of cultivated trees and shrubs*, 2nd edn. MacMillan, New York

- Reichard SH, White P (2001) Horticulture as a pathway of invasive plant introductions in the United States. *Bioscience* 51:103–113
- Rejmánek M (1996) A theory of seed plant invasiveness: the first sketch. *Biol Conserv* 78:171–181
- Richardson DM, Allsopp N, D'Antonio CM, Milton SJ, Rejmanek M (2000a) Plant invasions – the role of mutualisms. *Biol Rev* 75:65–93
- Richardson DM, Pyšek P, Rejmánek M, Barbour MG, Panetta FD, West CJ (2000b) Naturalization and invasion of alien plants: concepts and definitions. *Divers Distrib* 6:93–107
- Rizzo DM, Garbelotto M (2003) Sudden oak death: endangering California and Oregon forest ecosystems. *Front Ecol Environ* 1:197–204
- Robinson JP, Harris SA, Juniper BE (2001) Taxonomy of the genus *Malus* Mill. (Rosaceae) with emphasis on the cultivated apple, *Malus domestica* Borkh. *Plant Syst Evol* 226:35–58
- Roll-Hansen F (1978) Fungi dangerous at *Pinus contorta* with special reference to pathogens from North Europe. *Eur J Forest Pathol* 8:1–14
- Rosenzweig ML (1995) Species diversity in space and time. Cambridge University Press, Cambridge, UK
- Rosenzweig ML (2001a) The four questions: what does the introduction of exotic species do to diversity. *Evol Ecol Res* 3:361–367
- Rosenzweig ML (2001b) Loss of speciation rate will impoverish future diversity. *Proc Natl Acad Sci* 98:5404–5410
- Rossman AY (2001) A special issue on global movement of invasive plants and fungi. *Bioscience* 51:93–94
- Rossman AY (2009) The impact of invasive fungi on agricultural ecosystems in the United States. *Biol Invasions* 11:97–107
- Rowland LM (2006) America's first rare plant: the Franklin tree. *Terrain Org* 18:183–190
- Roy BA, Kirchner JW (2000) Evolutionary dynamics of pathogen resistance and tolerance. *Evolution* 54:51–63
- Savile DBO (1970a) Autoecious *Puccinia* species attacking *Cardueae* in North America. *Can J Bot* 48:1567–1584
- Savile DBO (1970b) Some Eurasian *Puccinia* species attacking *Cardueae*. *Can J Bot* 48:1553–1566
- Savile DBO (1973) Rusts that pass import inspection. *Can Plant Dis Surv* 53:105–106
- Schubert K et al (2007) Biodiversity in the *Cladosporium herbarum* complex (*Davidiellaceae*, *Capnodiales*), with standardisation of methods for *Cladosporium* taxonomy and diagnostics. *Stud Mycol* 58:105–156
- Schulz B, Boyle C (2005) The endophytic continuum. *Mycol Res* 109:661–686
- Shipunov A, Newcombe G, Raghavendra A, Anderson C (2008) Hidden diversity of endophytic fungi in an invasive plant. *Am J Bot* 95:1096–1108
- Sinclair WA, Lyon HH (2005) Diseases of trees and shrubs, 2nd edn. Cornell University Press, Ithaca, NY
- Sinclair WA, Lyon HH, Johnson WT (1987) Diseases of trees and shrubs. Cornell University Press, Ithaca, NY
- Smith H, Wingfield MJ, De Wet J, Coutinho TA (2000) Genotypic diversity of *Sphaeropsis sapinea* from South Africa and Northern Sumatra. *Plant Dis* 84:139–142
- Smith PM (1986) Native or introduced? problems in the taxonomy and plant geography of some widely introduced annual brome-grasses. *Proc R Soc Edinb* 89B:273–281
- Sniezko RA, Kegley AJ, Danchock R (2008) White pine blister rust resistance in North American, Asian and European species – results from artificial inoculation trials in Oregon. *Ann For Res* 51:53–66
- Stephan BR (2001) Studies of genetic variation with five-needle pines in Germany. In: Sniezko RA (ed) Breeding and genetic resources of five-needle pines: growth, adaptability and pest resistance, vol. RMRS-P-32. USDA Forest Service, Medford, USA, pp 98–102
- Stubblefield SP, Taylor TN (1988) Recent advances in palaeomycology. *New Phytol* 108:3–25
- Stukenbrock EH, McDonald BA (2008) The origins of plant pathogens in agro-ecosystems. *Annu Rev Phytopathol* 46:75–100

- Ta CH, Bartholomew B (1984) *Camellias*. Timber Press, Portland, Oregon
- Taavitsainen J-P, Simola H, Grönlund E (1998) Cultivation history beyond the periphery: early agriculture in the north European boreal forest. *J World Prehist* 12:199–253
- Tainter FH, Anderson RL (1993) Twenty-six new pine hosts of fusiform rust. *Plant Dis* 77:17–20
- Taylor JW, Turner E, Townsend JP, Dettman JR, Jacobson D (2006) Eukaryotic microbes, species recognition and the geographic limits of species: examples from the kingdom fungi. *Philos Trans R Soc Lond B Biol Sci* 361:1947–1963
- Thompson JN, Burdon JJ (1992) Gene-for-gene coevolution between plants and parasites. *Nature* 360:121–125
- Tuskan GA et al (2006) The genome of black cottonwood, *Populus trichocarpa* (Torr. & Gray). *Science* 313:1596–1604
- USDA, ARS, National Genetic Resources Program (n.d.) Germplasm Resources Information Network – (GRIN) [Online Database]. National Germplasm Resources Laboratory, Beltsville, MD
- Van der Kamp BJ (1991) Major gene resistance of Scots pine to western gall rust. *Can J For Res* 21:375–378
- Van Der Plank JE (1975) *Principles of plant infection*. Academic Press, New York, NY
- Vaughan DA, Balázs E, Heslop-Harrison JS (2007) From crop domestication to super-domestication. *Ann Bot* 100:893–901
- Villar M, Lefevre F, Bradshaw HD, Teissier du Cros E (1996) Molecular genetics of rust resistance in poplars (*Melampsora larici-populina* Kleb/*Populus* sp.) by bulked segregant analysis in a 2 × 2 factorial mating design. *Genetics* 143:531–536
- Wallerstein E (1974) *The modern World-system, vol I: capitalist agriculture and the origins of the European World-economy in the sixteenth century*. Academic Press, New York/London
- Wallerstein E (1980) *The modern World-system, vol II: mercantilism and the consolidation of the European World-economy 1600–1750*. Academic Press, New York
- Wallerstein E (1989) *The modern World-system, vol. III: the second great expansion of the capitalist World-economy, 1730–1840's*. Academic Press, San Diego
- Ward SM, Gaskin JF, Wilson LM (2008) Ecological genetics of plant invasion: what do we know. *Invasive Plant Sci Manag* 1:98–109
- Weldon C, Du Preez LH, Hyatt AD, Muller R, Speare R (2004) Origin of the amphibian chytrid fungus. *Emerging Infect Dis* 10:2100–2105
- Wells S (2007) *Deep ancestry: inside the genographic project: the landmark DNA quest to decipher our distant past*. National Geographic Society, Washington, D.C
- Williamson M, Fitter A (1996) The varying success of invaders. *Ecology* 77:1661–1666
- Wilson EO (2003) The encyclopedia of life. *Trends Ecol Evol* 18:77–80
- Wingfield MJ, Slippers B, Roux J, Wingfield BD (2001) Worldwide movement of exotic forest fungi, especially in the tropics and the southern hemisphere. *Bioscience* 51:134–140
- Wolfe BE, Husband BC, Klironomos JN (2005) Effects of a belowground mutualism on an aboveground mutualism. *Ecol Lett* 8:218–223
- Wu HX, Ying CC, Muir JA (1996) Effect of geographic variation and jack pine introgression on disease and insect resistance in lodgepole pine. *Can J For Res* 26:711–726
- Wyand RA, Brown JKM (2003) Genetic and forma specialis diversity in *Blumeria graminis* of cereals and its implications for host-pathogen co-evolution. *Mol Plant Pathol* 4:187–198
- Zaffarano PL, McDonald BA, Zala M, Linde CC (2006) Global hierarchical gene diversity analysis suggests the fertile crescent is not the center of origin of the barley scald pathogen *Rhynchosporium secalis*. *Phytopathology* 96:941–950
- Zambino PJ, Harrington TC (2005) *Ceratocystis fagacearum*: where did it come from? clues from genetic diversity and relatives. *Phytopathology* 95:S126
- Zerbe S, Wirth P (2006) Non-indigenous plant species and their ecological range in Central European pine (*Pinus sylvestris* L.) forests. *Ann For Sci* 63:189–203
- Ziller WG (1974) *The tree rusts of Western Canada*. Canadian Forestry Service, Victoria, British Columbia

# Chapter 2

## Molecular Techniques for Classification and Diagnosis of Plant Pathogenic Oomycota

Otmar Spring and Marco Thines

**Abstract** With a delay of approximately 10 years, molecular techniques came in use for the investigation of phylogenetic, taxonomic, and diagnostic problems in oomycetes. The particular problem in plant pathogenic Oomycota lies in their biotrophic nature, which prohibits axenic cultivation of the majority of species, in particular downy mildews and white blister rusts, on artificial media. This impeded the broad employment of basic techniques such as RFLP (restriction fragment length polymorphism) in investigations of Oomycota and required the development of specific PCR-based tools for identification and detection of minute pathogen amounts. When the first sequence analysis of genomic loci of oomycetes was conducted in the late 1980s, specific primers became available which allowed selective analysis of oomycete DNA in the presence of much higher amounts of host DNA. Since about 8 years, these methods have become routine in this field of research and have started turning the systematics of Oomycota upside down. A wide array of tools for the amplification of coding and noncoding gene loci helped to differentiate pathogen accessions, to restructure the phylogeny, to form monophyletic entities on all taxonomic levels, and to resolve unrealistically broad species concepts. Recent progress in sequencing ancient DNA from Oomycota allows the extension of taxonomic studies to herbarium collections. This broadens the basis of samples considerably and gives the chance to link molecular phylogenetic taxonomy with the traditional phenotype-based system. Moreover, molecular techniques gain growing importance in the identification of downy mildews and white blister rusts in plant pathology and in ecological studies. Their employment allows detection of Oomycota in asymptomatic infections of host plants and enables the identification of infested seeds or soils in agriculture. With the first whole genome sequencing of a *Phytophthora* species in 2003, the basis for functional genomics studies has been established. This will not only stimulate phylogenetic, taxonomic,

---

O. Spring and M. Thines  
Institute of Botany, University of Hohenheim, 70593 Stuttgart, Germany  
e-mail: spring@uni-hohenheim.de

and diagnostic research in plant pathogenic Oomycota, but also provide the basis for gaining deeper insights in their biology and interaction with their hosts.

## 2.1 Introduction

Molecular techniques have altered the understanding of the evolution and phylogeny of life within the past 30 years in an unprecedented dimension. It is only natural that this process started with the most familiar and the easiest accessible groups of organisms such as animals and higher plants. These investigations revealed a multitude of inconsistencies of the evolutionary relationships compared to the established taxonomy, especially above the generic level. The consequences for the reorganization of the systematics and taxonomy of these already well-known groups were however moderate and manageable, when compared with less-familiar groups such as prokaryotes, protozoa, algae, or fungi. The taxonomic rearrangement of the fungi started long before molecular techniques were at hand. The separation in Myxomycetes, Eumycetes, and Oomycota was based on fundamental cytological and biochemical differences. The particular mode of sexual reproduction of the diploid Oomycota is unparalleled in any other fungus-like entity (Tommerup 1981). In addition, their cellulosic cell wall (Bartnicki-Garcia 1968), the lysine synthesis pathway (Vogel 1960), and their sterol biosynthesis (Warner et al. 1982) are biochemical evidence to separate them from eumycotic fungi, to whom they resemble only superficially with respect to their hyphoidal organization and osmotic nutrition. The phylogenetic roots of the Oomycota became obvious from the flagellum, which because of the anterior insertion and its tripartite hairs unraveled them as part of the Straminipila (Vlk 1939; Patterson 1989; Dick 2001). Molecular data supported this origin (Leipe et al. 1994) and hinted at the possibility that Oomycota had separated before or after the uptake of secondary chloroplasts in this clade. Sequencing of the nucleus-encoded glyceraldehyde-3-phosphate dehydrogenase in Oomycota supports close relationships with the photosynthetic heterokonts in which this enzyme is plastid-targeted, thus favoring the loss of plastids in the nonphotosynthetic heterokonts (Harper and Keeling 2003). However, the initial rearrangements of the higher-level classification of the fungal organisms gave but a glimpse of the changes to come on all taxonomic levels with the advent of molecular phylogenetic investigations.

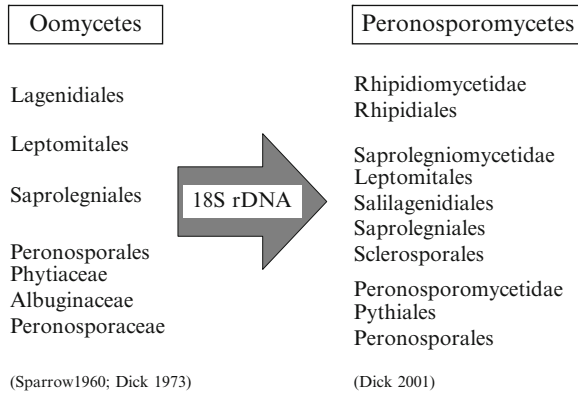
Within the Oomycota, until recently, the taxonomic concept was solely based on the few morphological characters available from the sparse features of an unsepted mycelium, sexually or asexually produced spores, and the mode of sporulation. In biotrophic sections of this phylum, additional information could be gained from host specificity, provided that vital material was accessible and the assumptions from field observation could be ensured by infection experiments. The host-based concept for species was broadly applied by Gäumann (1918, 1923) and still predominates in taxonomy. Paucity in differentiating morphological characters, in

addition to the lack of knowledge in host specificity and sexual reproduction between populations found on closely related hosts, resulted in a taxonomy of the plant pathogenic Oomycota with relatively few, but broad taxa (Yerkes and Shaw 1959) that were adopted especially by applied plant pathologists. For *Plasmopara halstedii*, one of the most relevant sunflower pathogens, no less than ca. 80 genera of the Asteraceae were listed as potential hosts (Leppik 1966) regardless of their evolutionary distance, geographic distribution, and untested susceptibility to strains from different hosts. Agronomic experiences showed that such a species concept was inappropriate and additional classifications on the level of *formae speciales* were introduced to handle important crop pathogens, as for instance the tobacco blue mould *Peronospora hyoscyami* de Bary f.sp. *tabacina* (Adam) Skalický. Meanwhile, molecular tools are available to reinvestigate species delimitation and phylogeny of the Oomycota. In the following chapters we summarize the recent progress in classification and diagnosis of the two major groups of obligate biotrophic (i.e., depending on a living substrate) Oomycota, the downy mildew pathogens, and the white blister rusts.

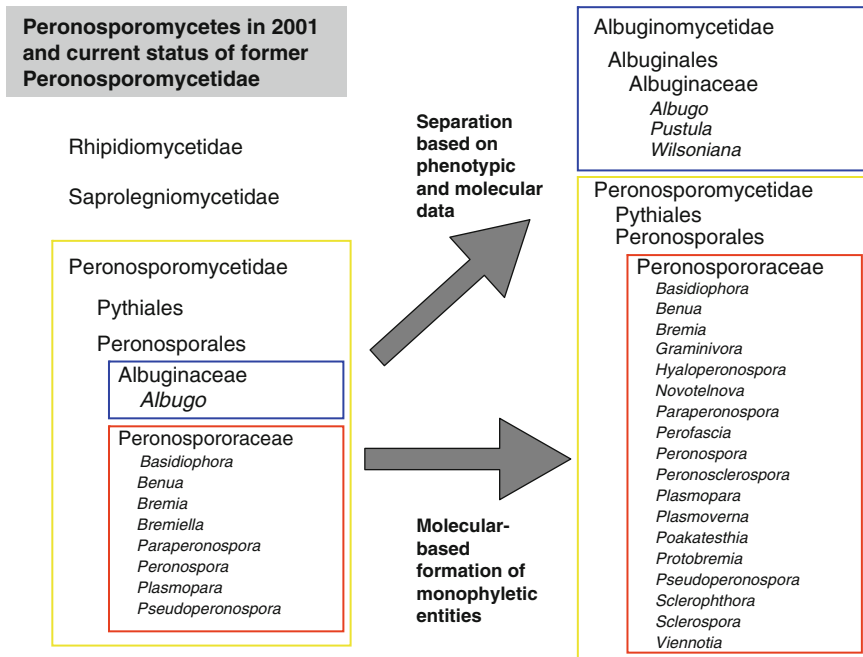
## 2.2 Upheaval of Oomycete Taxonomy in the Molecular Era

Ten years ago, only very few and punctual genetic data of Oomycota were available in public databases. The species selected for early studies were *Achlya bisexualis* (Gunderson et al. 1987), *Lagenidium giganteum* (Förster et al. 1990), and *Phytophthora megasperma* (Förster et al. 1990); all of these species can be cultured on artificial media. They stood exemplary for the Oomycota and early data served predominantly for supporting the separation of oomycetes from other fungal groups and to confirm the relationships with other straminipilous entities. The sequence loci used for early molecular phylogenetic studies were the mitochondrial cytochrome oxidase (*cox2*) (Hudspeth et al. 2000) and the nuclear 18S rDNA on the phylogenetic analysis of which Dick et al. (1999) justified the separation of the subclass division of the Peronosporomycetes into Saprolegniomycetidae and Peronosporomycetidae (Fig. 2.1). The molecular era of the obligate biotrophic Oomycota started when Petersen and Rosendahl (2000) sequenced partial 28S rDNA of *Peronospora farinosa* and *Albugo candida* to include these organisms in their phylogenetic analysis.

Meanwhile, a greater number of genetic loci are accessible for sequence comparison (Hudspeth et al. 2000; Riethmüller et al. 2002; Voglmayr 2003; Thines et al. 2006; Göker et al. 2007) and led to massive taxonomic rearrangements on all levels. The most fundamental steps were perhaps the separation of the white blister rusts from Peronosporomycetidae and the subsequent placement within the new subclass Albuginomycetidae (Thines and Spring 2005) and the reclassification of the graminicolous downy mildews within the Peronosporaceae (Riethmüller et al. 2002; Hudspeth et al. 2003; Thines et al. 2008). Although the former step was not entirely based on molecular data, sequence comparison of nrLSU (Riethmüller



**Fig. 2.1** Classification of the Oomycota in the pre molecular era and the consequences of first DNA sequences of the nuclear 18S rDNA, before the first comprehensive molecular phylogenies



**Fig. 2.2** Peronosporomycetes according to Dick (2001) and the current status of the former Peronosporomycetidae. Close relationships to Peronosporaceae of the paraphyletic genus *Phytophthora*, formerly placed in the Pythiales, have been recognized (Riethmüller et al. 2002; Göker et al. 2007); however, no formal solution for this has yet been proposed

et al. 2002), and *cox2* (mitochondrial cytochrome C oxidase gene) (Hudspeth et al. 2003; Thines et al. 2008) supported this view, therefore necessitating major changes in the taxonomy of plant parasitic oomycetes (Fig. 2.2).



As a consequence of intensive sampling of molecular genetic data and phylogenetic analysis, eight new genera were described within the Peronosporaceae alone, one genus was relegated into synonymy with *Plasmopara*, and it was realized that the graminicolous downy mildews are to be placed within the Peronosporaceae. Numerous transfers of taxa were made to newly formed monophyletic entities (Constantinescu and Fatehi 2002; Göker et al. 2004; Voglmayr et al. 2004; Constantinescu et al. 2005; Thines et al. 2006, 2007; Voglmayr and Thines 2007; Voglmayr and Constantinescu 2008). In many cases, this reorganization renewed the search for reliable phenotypic characters which coincide with the molecular genetic classification, a prerequisite for the adoption of such new concepts in applied phytopathology, as was urged previously (Spring and Thines 2004). In particular, it could be shown that fine morphology of the sporangiophores (Constantinescu and Fatehi 2002; Thines 2006), as well as haustoria (Voglmayr et al. 2004; Thines et al. 2006, 2007), and the oospore ornamentation (Voglmayr and Riethmüller 2006; Choi et al. 2007, 2008) are critically important characters. For extensive review see Voglmayr (2008).

The ongoing research activities are bidirectional. On the one side, a large number of taxa are still leant at very broad species concepts that require a more precise resolution, especially for large families, such as Fabaceae (García-Blázquez et al. 2008), Brassicaceae (Göker et al. 2004), Lamiaceae, Asteraceae, and Amaranthaceae (Choi et al. 2007). On the other hand, whole genome sequencing has reached Oomycota and will soon accelerate research in physiological and ecological aspects of this group (Birch et al. 2008). The genomes of four *Phytophthora* species are fully sequenced (for review see Lamour et al. 2007) and selected species of *Hyaloperonospora*, *Albugo*, and *Pustula* are currently under investigation. The results of genome sequencing will be an important source for the search of useful genes for taxonomic and phylogenetic investigations in Oomycota.

### 2.3 Molecular Tools for Reclassification and Identification of Oomycota

The application of molecular tools for the characterization of biotrophic organisms is a particular challenge because the obligate biotrophy hampers cultivation and the accumulation of pathogen material; therefore, these techniques were first used in non-biotrophic groups. Most stages of their life cycle are inevitably and tightly linked to living cells of their hosts. In Oomycetes this is true for all Albuginales (white blister rusts) and for the downy mildews (Peronosporaceae *pro parte*), whereas members of the second order “Pythiales” – a para- and polyphyletic assemblage – can be cultivated axenically on artificial media (e.g. *Pythium*, *Phytophthora*). The only cells of the biotrophic taxa which are accessible without contamination through host material are the spores, and these are often not available in sufficient amounts for several DNA or protein analyzes. For that reason, isozyme analysis and RFLP (restriction fragment length polymorphism) studies which had

**Table 2.1** Molecular-based techniques and their potential use for classification of biotrophic Oomycota as demonstrated for selected groups

	Useful at taxonomic level of	Research field of application	Example and reference
Isozyme analysis	Sub-species	Classification	<i>Plasmopara</i> (Komjáti et al. 2008)
RAPDs	Species to sub-species	Classification	<i>Plasmopara</i> (Roeckel-Drevet et al. 1997)
AFLPs	Species to sub-species	Classification	<i>Plasmopara</i> (Roeckel-Drevet et al. 1997)
iSSRs	Species to sub-species; crossing experiments	Classification	<i>Plasmopara</i> (Intelmann and Spring 2002; Gobbin et al. 2003)
SSU rDNA Sequencing	Kingdom to genus	Phylogeny	Peronosporomycetes (Dick et al. 1999)
LSU rDNA sequencing	Class to species	Phylogeny	Peronosporomycetes (Riethmüller et al. 1999, 2002; Petersen and Rosendahl 2000)
COX2 sequencing	Kingdom to species	Phylogeny and classification	Peronosporomycetes (Hudspeth et al. 2000, 2003; Thines et al. 2007; Choi et al. 2007b, 2008)
ITS sequencing	Family to species	Phylogeny and classification	Peronosporoaceae (Göker et al. 2004; Voglmayr 2003; Choi et al. 2006, 2007, 2008; Spring et al. 2006; Thines 2007)
SNPs	Species to sub-species; crossing analysis	Phylogeny, classification, population studies	<i>Phytophthora</i> ; <i>Plasmopara</i> (Martin 2008; Delmotte et al. 2008)
DNA barcoding	Species	Classification	–

successfully been employed for the investigation of *Phytophthora* (Oudemans and Coffey 1991; Förster and Coffey 1989) were in general not useful, unless large amounts of sporangia were gained through cultivation of the pathogen on host plants as was recently demonstrated for *P. halstedii* pathotypes screened by Komjáti et al. (2008).

Before PCR (polymerase chain reaction) techniques with oomycete-specific primers had been developed, various so-called fingerprint techniques were used for classification and taxonomic studies (Table 2.1). RAPD (randomly amplified polymorphic DNA) and AFLP (amplified fragment length polymorphism) fingerprints were used for differentiation of isolates of *P. halstedii*, the downy mildew pathogen of sunflower (Roeckel-Drevet et al. 1997). However, a reliable classification of pathotypes (physiological races) could not be achieved with this technique. Another fingerprint technique is on the basis of the polymorphism of microsatellite markers and simple sequence repeats which are widely distributed elements in eukaryotic genomes (Tautz 1989; Lagercrantz et al. 1993) and revealed to be

helpful for generating highly diverse fingerprint patterns in sporangial DNA samples of some downy mildew pathogens of crop plants (Intelmann and Spring 2002; Gobbin et al. 2003; Spring et al. 2007a; Komjati et al. 2007; Zipper et al. 2009). The amplification patterns allowed the differentiation of two related pathogen species on *Xanthium* and *Helianthus* (Komjáti et al. 2007). On the infraspecific level, population studies revealed low genetic variation in the grapevine downy mildew pathogen *Plasmopara viticola* (Gobbin et al. 2006; Delmotte et al. 2006) and in *P. halstedii* (Intelmann and Spring 2002), thus prohibiting identification of physiological races. In contrast, differentiation between fungicide sensitive and resistant genotypes of tobacco blue mould *Peronospora tabacina* based on iSSR polymorphisms was recently shown and used for a population study in field accessions from Europe (Zipper et al. 2009).

With the identification of DNA sequences of specific genes, analyzes regarding the identity and evolutionary history of obligate biotrophic oomycetes were greatly advancing. Because of the paucity of material, particularly those genomic regions for which multiple copies per cell exist were chosen for comparative studies. Such prerequisites were found in the repetitive elements of the nuclear ribosomal DNA and in the mitochondrial-encoded cytochrome C oxidase gene (*cox2*). The small subunit of the 18S rDNA (SSU) was used by Dick et al. (1999) to justify the separation of the Peronosporomycetes into the subclass taxa Saprolegniomycetidae and Peronosporomycetidae while other studies used *cox2* for tracing the phylogeny of these entities (Hudspeth et al. 2000, 2003; Cook et al. 2001, Choi et al. 2007, 2008; Thines et al. 2007, 2008). The large subunit of the 28S rDNA (LSU) initially served for the generic resolution of the Saprolegniomycetidae (Riethmüller et al. 1999) and has since been broadly used in many revisions of oomycete taxa (Riethmüller et al. 2002; Göker et al. 2003; Voglmayr et al. 2004; Thines et al. 2006; Voglmayr and Thines 2007). A major advantage of sequence-based classification and identification is its applicability on infected host plant tissue, because specific primers are used for amplifying the target gene in the presence of high amounts of host DNA background. On the other hand, SSU and LSU sequences often do not provide sufficient resolution for the classification of subgeneric taxa, and genomic regions of higher variability were searched for. Meanwhile, the ITS (internal transcribed spacer) region, and to a lesser extent the IGS (inter-genic spacer) region, two noncoding elements of the nuclear rDNA (Bachmann 1994), have become the most preferred sequences for studies on the lower ranking levels (Schurko et al. 2003; Wattier et al. 2003, for additional references see Spring 2004). Thereby, broad species concepts such as the *Hyaloperonospora* complex on Brassicaceae can be tested (Choi et al. 2003; Göker et al. 2003) or the *A. candida* complex on the same host family (Choi et al. 2006, 2007a, 2008). ITS sequencing is also a useful tool for the classification of pathogens on crop plants, when morphological characters like sporangial size are unsecure. Thus, the downy mildew of poppy (*Papaver somniferum*) is caused by two phenotypically similar, but not closely related taxa, *Peronospora arborescens* and *P. cristata*, and molecular data confirmed the latter to be responsible for epidemics in Tasmania (Scott et al. 2004), while the former is the prominent pathogen of poppy in Europe.

The potential of variation in ITS has not yet been fully explored. Repetitive elements were recently found in *P. halstedii* (Thines et al. 2005; Thines 2007) and *P. angustiterminalis* (Komjáti et al. 2008) which extended this noncoding region to an almost fourfold size in comparison to basal groups of the Peronosporaceae and may enable to trace the speciation process within this lineage.

On the infraspecific level, the above-mentioned molecular tools may sometimes provide insufficient resolution. In such cases, SNPs (single nucleotide polymorphisms) provide a promising new type of molecular marker, if sufficient genomic data have been established in the respective group of organisms (Schlotterer 2004). In plant pathogens, SNPs have sparsely been used so far (Morin et al. 2004), and this is true in particular for Oomycota. SNP-based population studies were carried out in *Phytophthora ramorum* (Martin 2008) and *Hyaloperonospora parasitica* s.l. (Clewes et al. 2007). In a recent study on *P. halstedii* field accessions, independent introduction events of the pathogen in French sunflower cultivation were traced on the basis of SNP data (Delmotte et al. 2008).

For the classification of unknown samples, genetic barcoding was shown to be a helpful tool (Hebert et al. 2003). In land plant taxonomy, the use of short genetic markers located in mitochondrial or plastidal DNA for the identification of organisms was introduced few years ago (Hebert and Gregory 2005; Chase et al. 2005) and meanwhile standardized protocols have been proposed (Chase et al. 2007). The technique has been adopted for the investigation in bryophytes (Pedersen et al. 2006), algae (Saunders 2008), and partly also for fungi (Seifert et al. 2007). For Oomycota, such attempts have to be considered still preliminary (Göker et al. 2007; Blair et al. 2008), but it is to be expected that a unifying approach will close this gap shortly. The mitochondrial cytochrome C oxidase gene could be one of the candidate genes for genetic barcoding in Oomycota and would allow comparison with other phyla, where this region was also selected (Seifert et al. 2007).

Recent advances in the investigation of herbarium specimens (May and Ristaino 2004; Ristaino 2006; Liu et al. 2007; Telle and Thines 2008) are promising to enable the inclusion historical specimens in molecular phylogenetic investigations and molecular barcoding. Telle and Thines (2008) have reported the use of only 2 mg of infected plant tissue of more than 100-year-old specimens. This incites the hope that it might be possible to include type specimens in the investigations, thereby linking the classical, Linnean system to modern molecular barcoding approaches.

## 2.4 Molecular Approaches for Tracing Occurrence of Oomycetes in Plants and Habitats

Molecular techniques provide unprecedented possibilities to identify plant pathogens on or within their hosts and in the environment. In Oomycota, only few reports yet exist on the employment of molecular markers for tracing their occurrence in

host organisms or in soil (e.g. Aegerter et al. 2002; Belbahri et al. 2005; Hukkanen et al. 2006). This is remarkable, taking into account that for many biotrophic species on wild host plants, little more than the mode of sporulation and the disease symptoms are known. Ways of overwintering and developmental stages between penetration of the host and sporulation on its surface are mostly unexplored, even in many economically important diseases of crop plants.

Several observations of recurrent and epidemic infections of plants in a certain developmental stage and subsequent seemingly unaffected growth without infection symptoms support the assumption that the pathogen may pass through an asymptomatic or endophytic life stage. Typical examples are the white blister rusts of the genus *Albugo* on Brassicaceae, for which Jacobson et al. (1998) had postulated an endophytic persistence, because in their study oomycetes were detected by means of specific ITS primers in DNA extracts from symptomless host tissue. According to our own unpublished observations, this appears not to be an exception in biotrophic Oomycota, but may be paralleled by several downy mildew species, e.g. *Peronospora veronicae* on *Veronica* spp., and *Hyaloperonospora* spp. on *Cardamine* and *Erysimum*.

Such latent types of infection are also known from pathogens on crop plants such as *P. halstedii* on sunflower (Cohen and Sackston 1974; Spring 2001) or *Peronospora sparsa* on arctic bramble and boysenberry (Hukkanen et al. 2006). In the latter case, symptomless phases in woody parts and in the root stock of the host (Lindquist et al. 1998) ensure overwintering of the pathogen. Similarly, the survival of the grape downy mildew *P. viticola* with perennial mycelium in *Vitis* shoots and dormant buds had been postulated (Pieth 1957; Rumbou and Geissler 2006). The root system and rhizome of perennial hosts can be inhabited by the pathogen that undergoes unrecognized hibernation until symptoms appear on aerial plant parts in the next season. This has been observed for *P. halstedii* in the perennial sunflower *Helianthus divaricatus* (Nishimura 1922) and more recently in the hybrid species *Helianthus x laetiflorus* (Spring et al. 2003). In the rootstock of hop plants, hyphae of *Pseudoperonospora humuli* were detected microscopically, when epidemics of the pathogen had reached for the first time in hop gardens in England (Salmon and Ware 1925). The perennial mycelium is responsible for the occurrence of diseased, stunted shoots in April and May, and gives rise to secondary infection. Tracing pathogen contamination in asymptomatic host tissue is particularly important in plant propagation which is based on cuttings and grafting. Aegerter et al. (2002), for instance, used PCR techniques successfully for the detection of *P. sparsa* in the shoot cortex and crown tissue of asymptomatic rose plants which were chosen to serve as a source of propagation material. In plant breeding, sensitive tests for the detection of asymptomatic infections could be helpful to avoid false evaluations of seemingly resistant plants. For the quantification of the infection, real-time PCR with downy mildew specific primers was shown to be useful (Hukkanen et al. 2006).

Another important developmental stage of symptomless occurrence of vital structures of biotrophic oomycetes involves seeds. Besides ensuring the survival during winter this stage supports the distribution of the pathogen and the spread through seed dispersal. For oomycetes on wild host plants, this phenomenon has not

been explored yet, whereas seed contamination of crop plants was shown for the downy mildew pathogen of basil (Belbahri et al. 2005) as well as for the white blister rust *Pustula* on sunflower (Viljoen et al. 1999). With the globalization of seed trading, this way of pathogen distribution has become one of the major problems in agri- and horticulture. Quarantine regulations try to impede seed transmission of diseases, but fast, sensitive and reliable detection methods are still mostly lacking. While germinating and cultivating an appropriate amount of seeds, evaluating the plants for disease symptoms is still the common way of testing seed contamination; molecular techniques have slowly been developed for oomycetes, but tests have not yet been brought into practical usage. For example, sunflower seed contamination with *P. halstedii* was investigated with various methods. PCR-based detection was attempted with selective oligonucleotide primers (Roedel-Drevet et al. 1999; SAYS-LESAGE et al. 2000) and with LSU-based primers (Ioos et al. 2007). An ELISA test was developed by Bouterige et al. (2000) and pathogen-specific fatty acids were used for the detection by Spring and Haas (2004). In *Peronospora* parasitic to basil, specific primers deduced from ITS sequences not only allowed the detection of the downy mildew of basil in seeds and plant tissue, but also enabled quantification of the contamination by using real-time PCR (Belbahri et al. 2005). However, in many cases, the problem for bringing such a test into practice is not only the sensitivity of system, which, in case of sunflower, has proven to be close to market needs and allowed the detection of one contaminated seed out of 50 (Spring and Haas 2004) or even out of 400 (Thines et al. 2004). Perhaps the major obstacle is drawing of a representative sample from large seed batches.

A similar problem is the detection of soil contamination with infective structures of the pathogen. Oospores of Oomycota can survive over 10 years or more, hence crop rotation is usually ineffective to prevent yield loss when replanting is made on a previously diseased field. The ability to determine whether a field contains a pathogen is of value both to growers and to researchers, but reports for oomycetes on this topic are still fairly rare. Pratt and Janke (1978) documented the infestation of soil with oospores of *Peronosclerospora sorghii* and Van der Gaag and Frinking (1997) enriched and extracted oospores of *Peronospora viciae* from soil by means of sieves. An estimation of inoculum potential for the infection of host plants by planting seeds in oospore contaminated soil was reported for *Aphanomyces euteiches*, a root pathogen of pea (Malvick et al. 1994) and for the sunflower downy mildew *P. halstedii* (Gulya 2004). As in the latter case, the applied technique is often a time and resource consuming bioassay that counts the ratio of infected seedlings after planting them in the soil sample under investigation. The adoption of PCR-based techniques to trace oomycetes in soil has so far been limited to *Pythium* (Wang and Chang 2003) and *Phytophthora* species (Hussain et al. 2005; Wang et al. 2006; Pavon et al. 2008) and no similar reports exist for downy mildews or white blister rusts. The progress made by molecular approaches in comparison to the bioassay technique is considerable with respect to time consumption and sensitivity. Thus, detection from soil required only 6 h (Wang et al. 2006), whereas bioassays take weeks (Gulya 2004). The limits in sensitivity improved significantly from approximately ten oospores per gram soil (Wang and Chang 2003) to one

oospores per 10 g of soil (Wang et al. 2006), but this depends on the soil screening technique (e.g. Pavon et al. 2008) employed before DNA extraction, and still represents at most a heavily contaminated soil. A burdensome problem for the practical application of such tests is similar as in the seed contamination tests mentioned above, lying in the acquisition of representative soil samples from the fields. The molecular techniques for tracing oomycetes in soil could be used in a modified way also for horticulture where hydroponic irrigation has become popular. Continuous monitoring of the irrigation water could help to identify pathogen contamination at a very early stage and to prevent epidemics in greenhouse cultures. Multiplex detection systems, as recently developed for the detection of fungal and oomycete pathogens of solanaceous crops (Zhang et al. 2008) could help to reduce the costs for the disease management.

## 2.5 Concluding Remarks

The progress made within the past few years in using molecular tools for exploring evolution, taxonomy, and classification of Oomycota is brisk and diminished the distance in knowledge to other eukaryotic organisms rapidly. As the first genomes of plant pathogenic oomycetes were unraveled, the base has been established to resolve the long list of compelling questions. Besides reorganizing the diversity of Oomycota by forming monophyletic entities and splitting unnatural broad taxa, the focus of research will soon shift to aspects of virulence mechanisms, coevolution, oomycete ecology, and agronomically relevant problems.

**Acknowledgments** Funding by the DFG granted to M. Thines is gratefully acknowledged.

## References

- Aegerter BJ, Nunez JJ, Davis RM (2002) Detection and management of downy mildew in rose rootstock. *Plant Dis* 86:1363–1368
- Bachmann K (1994) Molecular markers in plant ecology. *New Phytol* 126:403–418
- Bartnicki-Garcia S (1968) Cell wall chemistry, morphogenesis and taxonomy of fungi. *Annu Rev Microbiol* 22:87–108
- Belbahri L, Calmin G, Pawlowski J, Lefort F (2005) Phylogenetic analysis and real time PCR detection of a presumably undescribed *Peronospora* species on sweet basil and sage. *Mycol Res* 109:1276–1287
- Birch PR, Boevink PC, Gilroy EM, Hein I, Pritchard L, Whisson SC (2008) Oomycete RXLR effectors: delivery, functional redundancy and durable disease resistance. *Curr Opin Plant Biol* 11:373–379
- Bouterige S, Robert R, Marot-Leblond A, Senet J-M (2000) Development of an ELISA test to detect *Plasmopara halstedii* antigens in seed. In: Proceedings of the 15th International Sunflower Conference, Toulouse, France, pp F44–F49

- Chase MW, Salamin N, Wilkinson M, Dunwell JM, Kesanakurthi RP, Haider N, Savolainen V (2005) Land plants and DNA barcodes: short-term and long-term goals. *Philos Trans R Soc B Biol Sci* 360:1889–1895
- Chase MW, Cowan RS, Hollingsworth PM, van den Berg C, Madrinan S, Petersen G, Seberg O, Jorgensen T, Cameron KM, Carine M, Pedersen N, Hedderson TAJ, Conrad F, Salazar GA, Richardson JE, Hollingsworth ML, Barraclough TG, Kelly L, Wilkinson M (2007) A proposal for a standardised protocol to barcode all land plants. *Taxon* 56:295–299
- Choi Y-J, Hong S-B, Shin H-D (2003) Diversity of the *Hyaloperonospora parasitica* complex from core brassicaceous hosts based on ITS rDNA sequences. *Mycol Res* 107:1314–1322
- Choi Y-J, Hong S-D, Shin H-D (2006) Genetic diversity within the *Albugo candida* complex (Peronosporales, Oomycota) inferred from phylogenetic analysis of ITS rDNA and COX2 mtDNA sequences. *Mol Phylogenet Evol* 40:400–409
- Choi Y-J, Shin H-D, Hong S-D, Thines M (2007a) Morphological and molecular discrimination among *Albugo candida* materials infecting *Capsella bursa-pastoris* world-wide. *Fungal Divers* 27:11–34
- Choi YJ, Hong SB, Shin HD (2007b) Re-consideration of *Peronospora farinosa* infecting *Spinacia oleracea* as distinct species, *Peronospora effusa*. *Mycol Res* 110:381–391.
- Choi Y-J, Shin H-D, Thines M (2008) Evidence for uncharted biodiversity the *Albugo candida* complex, with the description of a new species. *Mycol Res* 112:1327–1334
- Clewes E, Barbara DJ, Kennedy R (2007) Progress in the development of tools for molecular epidemiology of downy mildew on vegetable in *Brassica*. In: Lebeda A, Spencer-Phillips PTN (eds) *Advances in Downy Mildew Research Vol. 3*, Olomouc, Czech Republic, pp 113–118
- Cohen Y, Sackston WE (1974) Seed infection and latent infection of sunflower by *Plasmopara halstedii*. *Can J Bot* 52:231–236
- Constantinescu O, Fatehi J (2002) *Peronospora*-like fungi (Chromista, Peronosporales) parasitic to Brassicaceae and related hosts. *Nova Hedwigia* 74:291–338
- Constantinescu O, Voglmayr H, Fatehi J, Thines M (2005) *Plasmoverna* gen. nov., and the taxonomy and nomenclature of *Plasmopara* (Chromista, Peronosporales). *Taxon* 54:813–821
- Cook KL, Hudspeth DSS, Hudspeth MES (2001) A *cox2* phylogeny of representative marine Peronosporomycetes. *Nova Hedwigia* 122:231–243
- Delmotte F, Chen WJ, Richard-Cervera S, Greif C, Papura D, Giresse X, Mondor-Genson G, Corio-Costet MF (2006) Microsatellite DNA markers for *Plasmopara viticola*, the causal agent of downy mildew of grapes. *Mol Ecol Notes* 6:379–381
- Delmotte F, Giresse X, Richard-Cervera S, M'Baya J, Vear F, Tourvieille J, Walser P, Tourvieille de Labrouhe D (2008) Single nucleotide polymorphisms reveal multiple introductions into France of *Plasmopara halstedii*, the plant pathogen causing sunflower downy mildew. *Infect Genet Evol* 8:534–540
- Dick MW (2001) *Straminipilous Fungi*. Kluwer, Dordrecht, The Netherlands
- Dick MW, Vick MC, Gibbings JG, Hedderson TA, Lastra CCL (1999) 18S rDNA for species of *Leptoglenia* and other Peronosporomycetes: justification for the subclass taxa Saprolegniomycetidae and Peronosporomycetidae and division of the Saprolegniaceae sensu lato into Leptogleniaceae and Saprolegniaceae. *Mycol Res* 103:1119–1125
- Förster H, Coffey MD (1989) Approaches to the taxonomy of *Phytophthora* using polymorphisms in mitochondrial and nuclear DNA. In: Lucas JA, Shattock RC, Shaw DS, Cooke LR (eds) *Phytophthora*. Cambridge University Press, Cambridge, UK, pp 164–183
- Förster H, Coffey MD, Elwood H, Sogin ML (1990) Sequence analysis of the small subunit ribosomal RNAs of three zoosporic fungi and implications for fungal evolution. *Mycologia* 82:306–312
- García-Blázquez G, Göker M, Voglmayr H, Martin MP, Telleria MT, Oberwinkler F (2008) Phylogeny of *Peronospora*, parasitic on Fabaceae, based on ITS sequences. *Mycol Res* 112:502–512
- Gäumann E (1918) Über die Formen der *Peronospora parasitica* (Pers.) Fries. Beihefte zum Botanischen Zentralblatt 35:395–533



- Gäumann E (1923) Beiträge zu einer Monographie der Gattung *Peronospora* Corda. Beiträge zur Kryptogamenflora der Schweiz 5:1–360
- Gobbin D, Pertot I, Gessler C (2003) Identification of microsatellite markers for *Plasmopara viticola* and establishment of high throughput method for SSR analysis. *Eur J Plant Pathol* 109:153–164
- Gobbin D, Rumbou A, Linde CC, Gessler C (2006) Population genetic structure of *Plasmopara viticola* after 125 years of colonization in European vineyards. *Mol Plant Pathol* 7:519–531
- Göker M, Voglmayr H, Riethmüller A, Weiß M, Oberwinkler F (2003) Taxonomic aspects of Peronosporaceae inferred from Bayesian molecular phylogenetics. *Can J Bot* 81:1–12
- Göker M, Riethmüller A, Voglmayr H, Weiß M, Oberwinkler F (2004) Phylogeny of Hyaloperonospora based on nuclear ribosomal internal transcribed spacer sequences. *Mycol Prog* 3: 83–176
- Göker M, Voglmayr H, Riethmüller A, Oberwinkler F (2007) How do obligate parasites evolve? A multi-gene phylogenetic analysis of downy mildews. *Fungal Genet Biol* 44:105–122
- Gulya TJ (2004) A seedling bioassays to detect the presence of *Plasmopara halstedii* in soil. In: Spencer-Phillips P, Jeger M (eds) *Advances in Downy Mildew Research*, Vol 2. Kluwer, Dordrecht, The Netherlands, pp 233–240
- Gunderson JH, Elwood H, Ingold A, Kindle A, Sogin ML (1987) Phylogenetic relationships between chlorophytes, chrysophytes and oomycetes. *Proc Natl Acad Sci USA* 84:5823–5827
- Harper JT, Keeling PJ (2003) Nucleus-encoded, plastid-targeted glyceraldehyde-3-phosphate dehydrogenase (GAPDH) indicates a single origin for chromalveolate plastids. *Mol Biol Evol* 20:1730–1735
- Hebert PDN, Gregory TR (2005) The promise of DNA barcoding for taxonomy. *Syst Bot* 54:852–859
- Hebert PDN, Ratnasingham S, DeWaard JR (2003) Barcoding animal life: Cytochrome c oxidase subunit 1 divergences among closely related species. *Proc R Soc B Biol Sci* 270:96–99
- Hudspeth DSS, Nadler SA, Hudspeth MES (2000) A *cox2* molecular phylogeny of the Peronosporomycetes. *Mycologia* 92:674–684
- Hudspeth DSS, Stenger D, Hudspeth MES (2003) A *cox2* phylogenetic hypothesis for the downy mildews and white rusts. *Fungal Divers* 13:47–57
- Hukkanen A, Pietikäinen L, Kärenlampi S, Kokko H (2006) Quantification of downy mildew (*Peronospora sparsa*) in *Rubus* species using real-time PCR. *Eur J Plant Pathol* 116:225–235
- Hussain S, Lees AK, Duncan JM, Cooke DEL (2005) Development of a species-specific and sensitive detection assay for *Phytophthora infestans* and its application for monitoring of inoculum in tubers and soil. *Plant Pathol* 54:373–382
- Intelmann F, Spring O (2002) Analysis of total DNA by minisatellite and simple-sequence repeat primers for the use of population studies in *Plasmopara halstedii*. *Can J Microbiol* 48:555–559
- Ioos R, Laugustin L, Rose S, Tourvieille J, Tourvieille de Labrouhe D (2007) Development of a PCR test to detect the downy mildew causal agent *Plasmopara halstedii* in sunflower seeds. *Plant Pathol* 56:209–218
- Jacobson DJ, LeFebvre SM, Ojerio RS, Berwald N, Heikkinen E (1998) Persistent, systemic, asymptomatic infections of *Albugo candida*, an oomycete parasite, detected in three wild crucifer species. *Can J Bot* 76:739–750
- Komjáti H, Walcz I, Viranyi F, Zipper R, Thines M, Spring O (2007) Characteristics of a *Plasmopara angustiterminalis* isolate from *Xanthium strumarium*. *Eur J Plant Pathol* 119:421–428
- Komjáti H, Bakony J, Spring O, Viranyi F (2008) Isozyme analysis of *Plasmopara halstedii* using cellulose acetate gel electrophoresis. *Plant Pathol* 57:57–63
- Lagercrantz U, Ellegren H, Andersson L (1993) The abundance of various polymorphic microsatellite motifs differs between plants and vertebrates. *Nucleic Acids Res* 21:1111–1115
- Lamour K, Win J, Kamoun S (2007) Oomycete genomics: new insights and future directions. *FEMS Microbiol Lett* 274:1–8

- Leipe DD, Wainright PO, Gunderson JH, Porter D, Patterson DJ, Valois F, Himmerich S, Sogin ML (1994) The stramenopiles from a molecular perspective: 16S-like rRNA sequences from *Labyrinthuloides minuta* and *Cafeteria roenbergensis*. *Phycologia* 33:369–377
- Leppik EE (1966) Origin and specialization of *Plasmopara halstedii* complex on the Compositae. *FAO Plant Protect Bull* 14:72–76
- Lindquist H, Koponen H, Valkonen JPT (1998) *Peronospora sparsa* on cultivated *Rubus arcticus* and its detection by PCR based on ITS sequences. *Plant Dis* 82:1304–1311
- Malvick DK, Paercich JA, Pfleger FL, Givens J, Williams HL (1994) Evaluation of methods for estimating inoculum potential of *Aphanomyces euteiches* in soil. *Plant Dis* 78:361–365
- Martin FN (2008) Mitochondrial haplotype determination in the oomycete plant pathogen *Phytophthora ramorum*. *Curr Genet* 54:23–34
- May KJ, Ristaino JB (2004) Identity of the mtDNA haplotype(s) of *Phytophthora infestans* in historical specimens from the Irish Potato Famine. *Mycol Res* 108:471–479
- Morin PA, Luikart G, Wayne RK (2004) SNPs in ecology, evolution and conservation. *Trends Ecol Evol* 19:208–216
- Nishimura M (1922) Studies in *Plasmopara halstedii*. *J Coll Agric Hokkaido Imperial University* 11:185–210
- Oudemans P, Coffey MD (1991) Isozyme comparison within and among worldwide sources of three morphologically distinct species of *Phytophthora*. *Mycol Res* 95:19–30
- Patterson DJ (1989) Stramenopiles: chromophytes from a protistological perspective. In: Green JC, Leadbeater BSC, Diver WL (eds). *The chromophyte algae: problems and perspectives*. Clarendon Press, Oxford 357–379
- Pavon CF, Babadoost M, Lambert KN (2008) Quantification of *Phytophthora capsici* oospores in soil by sieving-centrifugation and real-time polymerase chain reaction. *Plant Dis* 92:143–149
- Pedersen N, Russell SJ, Newton AE, Ansell SW (2006) A novel molecular protocol for the rapid extraction of DNA from bryophytes and utility of direct amplification of DNA from a single dwarf male. *Bryologist* 109:257–264
- Petersen AB, Rosendahl S (2000) Phylogeny of the Peronosporomycetes (Oomycota) based on partial sequences of the large ribosomal subunit (LSU rDNA). *Mycol Res* 104:1295–1303
- Pioth L (1957) Untersuchungen über anatomische und physiologische Eigenschaften resistenter und anfälliger Reben in Beziehung zur Entwicklung von *Plasmopara viticola*. *Zeitschrift für Pflanzenzüchtung* 37:127–158
- Pratt RG, Janke GD (1978) Oospores of *Sclerospora sorghi* in soils of South Texas and their relationships to the incidence of downy mildew in grain sorghum. *Phytopathology* 68:1600–1605
- Riethmüller A, Weiß M, Oberwinkler F (1999) Phylogenetic studies of Saprolegniomycetidae and related groups based on nuclear large subunit DNA sequences. *Can J Bot* 77:1790–1800
- Riethmüller A, Voglmayr H, Göker M, Weiß M, Oberwinkler F (2002) Phylogenetic relationships of the downy mildews (Peronosporales) and related groups based on nuclear large subunit ribosomal DNA sequences. *Mycologia* 94:834–849
- Ristaino JB (2006) Tracking the evolutionary history of the potato late blight pathogen with historical collections. *Outlooks Pest Manage* 17:228–231
- Roeckel-Drevet P, Coelho V, Tourvieille J, Nicolas P, Tourvieille De Labrouhe D (1997) Lack of genetic variability in French identified races of *Plasmopara halstedii*, the cause of downy mildew in sunflower *Helianthus annuus*. *Can J Microbiol* 43:260–263
- Roeckel-Drevet P, Tourvieille J, Drevet JR, Says-Lesage V, Nicolas P, Tourvieille De Labrouhe D (1999) Development of a polymerase chain reaction diagnostic test for the detection of the biotrophic pathogen *Plasmopara halstedii* in sunflower *Helianthus annuus*. *Can J Microbiol* 45:797–803
- Rumbou A, Geissler C (2006) Particular structure of *Plasmopara viticola* populations evolved under Greek Island conditions. *Phytopathology* 96:501–509
- Salmon ES, Ware WM (1925) On the presence of a perennial mycelium in *Pseudoperonospora humuli* (Miyabe & Takah.) Wils. *Nature* 116:134–135

- Saunders GW (2008) A DNA barcode examination of the red algal family Dumontiaceae in Canadian waters reveals substantial cryptic species diversity. 1. The foliose *Dilsea-Neodilsea* complex and *Weeksia*. *Can J Bot* 86:773–789
- Says-Lesage V, Meliala C, Tourvieille J, Nicolas P, Tourvieille de Labrouhe D, Roeckel-Drevet P (2000) Development of a test to diagnose the presence of sunflower downy mildew (*Plasmopara halstedii*) in seed samples. In: Proceedings of the 15th International Sunflower Conference, Toulouse, France, pp F38–F43
- Schlotterer C (2004) The evolution of molecular markers – just a matter of fashion? *Nat Rev Genet* 5:63–69
- Schurko A, Mendoza L, de Cock AWAM, Klassen GR (2003) Evidence for geographic clusters: Molecular genetic differences among strains of *Pythium insidiosum* from Asia, Australia and the Americas are explored. *Mycologia* 95:200–2008
- Scott JB, Hay FS, Wilson CR (2004) Phylogenetic analysis of the downy mildew pathogen of oilseed poppy in Tasmania, and its detection by PCR. *Mycol Res* 108:198–205
- Seifert KA, Samson RA, de Waard JR, Houbraken J, Levesque AC, Moncalvo J-M, Louis-Seize G, Hebert DN (2007) Prospects for fungus identification using *CO<sub>1</sub>* DNA barcodes, with *Penicillium* as a test case. *Proc Natl Acad Sci USA* 104:3901–3906
- Spring O (2001) Nonsystemic infections of sunflower with *Plasmopara halstedii* and their putative role in the distribution of the pathogen. *J Plant Dis Protect* 108:329–336
- Spring O (2004) Potential and limits for the use of new characters in the systematics of biotrophic oomycetes. In: Spencer-Phillips P, Jeger M (eds) *Advances in Downy Mildew Research, Vol.2*, Kluwer Academic Publisher, The Netherlands, pp 211–231
- Spring O, Haas K (2004) Eicosapentaenoic acid, a possible marker for downy mildew contamination in sunflower. In: Spencer-Phillips P, Jeger M (eds) *Advances in Downy Mildew Research, Vol 2*. Kluwer, Dordrecht, The Netherlands, pp 241–247
- Spring O, Thines M (2004) On the necessity of new characters for classification and systematics of biotrophic Peronosporomycetes. *Planta* 219:910–914
- Spring O, Voglmayr H, Riethmüller A, Oberwinkler F (2003) Characterization of a *Plasmopara* isolate from *Helianthus x laetiflorus* based on cross infection, morphological, fatty acids and molecular phylogenetic data. *Mycol Prog* 2:163–170
- Spring O, Bachofer M, Thines M, Riethmüller A, Göker M, Oberwinkler F (2006) Intraspecific relationship of *Plasmopara halstedii* isolates differing in pathogenicity and geographic origin based on ITS sequence data. *European Journal of Plant Pathology* 114:309–315
- Spring O, Keil S, Zipper R (2007a) Field monitoring reveals two genotypes of *Peronospora tabacina* in German tobacco cultures. In: Lebeda A, Spencer-Phillips PTN (eds) *Advances in Downy Mildew Research, Proceedings of the 2nd International Downy Mildew Symposium, Vol. 3*. Olomouc, Kostelec na Hane, Czech Republic, pp 107–111
- Spring O, Hammer TR, Tscheschner H, Zipper R (2007b) Interspecific recombinants from dual infection of sunflower with *Plasmopara halstedii* and *P. angustiterminalis*. In: Proceedings of the Jahrestagung der Deutschen Botanischen Gesellschaft, Hamburg, p 70
- Tautz D (1989) Hypervariability of simple sequences as a general source for polymorphic DNA markers. *Nucleic Acids Res* 17:6463–6467
- Telle S, Thines M (2008) Amplification of *cox2* (620bp) from 2 mg of up to 129 years old herbarium specimens, comparing 19 extraction methods and 15 polymerases. *PLoS ONE* 3:e3584
- Thines M (2006) Evaluation of characters available from herbarium vouchers for the phylogeny of the downy mildew genera (Chromista, Peronosporales), with focus on scanning electron microscopy. *Mycotaxon* 97:195–218
- Thines M (2007) Characterisation and phylogeny of repeated elements giving rise to exceptional length of ITS2 in several downy mildew genera (Peronosporaceae). *Fungal Genet Biol* 44:199–207
- Thines M, Spring O (2005) A revision of *Albugo* (Chromista, Peronosporomycetes). *Mycotaxon* 92:443–458

- Thines M, Bachofer M, Zipper R, Spring O (2004) PCR-mediated detection of *Plasmopara halstedii* in sunflower cultivation. Proceedings of the 54th Deutsche Pflanzenschutztagung. Hamburg, Germany, p 219
- Thines M, Komjáti H, Spring O (2005) Exceptional length of ITS in *Plasmopara halstedii* is due to multiple repetitions in the ITS-2 region. *Eur J Plant Pathol* 112:395–398
- Thines M, Göker M, Spring O, Oberwinkler F (2006) A revision of *Bremia graminicola*. *Mycol Res* 110:646–656
- Thines M, Göker M, Oberwinkler F, Spring O (2007) A revision of *Plasmopara penniseti*, with implications for the host range of the downy mildews with pyriform haustoria. *Mycol Res* 111:1377–1385
- Thines M, Göker M, Telle S, Ryley M, Mathur K, Narayana YD, Spring O, Thakur RP (2008) Phylogenetic relationships of graminicolous downy mildews based on *cox2* sequence data. *Mycol Res* 112:345–351
- Tommerup IC (1981) Cytology and genetics of downy mildews. In: Spencer DM (ed) *The Downy Mildews*. Academic, London, UK, pp 121–142
- Van der Gaag DJ, Frinking HD (1997) Extraction of oospores of *Peronospora viciae* from soil. *Plant Pathol* 46:675–679
- Viljoen A, van Wyk PS, Jooste WJ (1999) Occurrence of the white rust pathogen, *Albugo tragopogonis*, in seed of sunflower. *Plant Dis* 83:77
- Vlk W (1939) Über die Geißelstruktur der Saprolegniaceenschwärmer. *Arch Protistenk* 92:157–160
- Vogel HJ (1960) Two modes of lysine synthesis among lower fungi: evolutionary significance. *Biochem Biophys Acta* 41:172–173
- Voglmayr H (2003) Phylogenetic relationships of *Peronospora* and related genera based on nuclear ribosomal ITS sequences. *Mycol Res* 107:1–11
- Voglmayr H (2008) Progress and challenges in systematics of downy mildews and white blister rusts: new insights from genes and morphology. *Eur J Plant Pathol* 122:3–18
- Voglmayr H, Constantinescu O (2008) Revision and reclassification of three *Plasmopara* species based on morphological and molecular phylogenetic data. *Mycol Res* 112:487–501
- Voglmayr H, Riethmüller A (2006) Phylogenetic relationships of *Albugo* species (white blister rusts) on LSU rDNA sequence and oospore data. *Mycol Res* 110:75–85
- Voglmayr H, Thines M (2007) Phylogenetic relationships and nomenclature of *Bremiella sphaerosperma* (Chromista, Peronosporales). *Mycotaxon* 100:11–20
- Voglmayr H, Riethmüller A, Göker M, Weiss M, Oberwinkler F (2004) Phylogenetic relationships of *Plasmopara*, *Bremia* and other genera of downy mildew pathogens with pyriform haustoria based on Bayesian analysis of partial LSU rDNA sequence data. *Mycol Res* 108:1011–1024
- Wang PH, Chang CW (2003) Detection of the low-germination-rate resting oospores of *Pythium myriotylum* from soil by PCR. *Lett Appl Microbiol* 36:157–161
- Wang Y, Zhang W, Wang Y, Zheng X (2006) Rapid and sensitive detection of *Phytophthora sojae* in soil and infected soybeans by species-specific polymerase chain reaction assays. *Phytopathology* 96:1315–1321
- Warner SA, Eierman DF, Sovocool GW, Domnas AJ (1982) Cycloartenol-derived sterol biosynthesis in Peronosporales. *Proc Natl Acad Sci USA* 79:3769–3772
- Wattier RAM, Gathercole LL, Assinder SJ, Gliddon CJ, Deahl KL, Shaw DS, Mills DI (2003) Sequence variation of intergenic mitochondrial DNA spacers (mtDNA-IGS) of *Phytophthora infestans* (Oomycetes) and related species. *Mol Ecol Notes* 3:136–138
- Yerkes WD, Shaw CG (1959) Taxonomy of *Peronospora* species on Cruciferae and Chenopodiaceae. *Phytopathology* 49:499–507
- Zhang N, McCarthy ML, Smart CD (2008) A Macroarray system for the detection of fungal and oomycete pathogens of solanaceous crops. *Plant Dis* 92:953–960
- Zipper R, Hammer TR, Spring O (2009) PCR-based monitoring of recent isolates of tobacco blue mold from Europe reveals the presence of two genetically distinct phenotypes differing in fungicide sensitivity. *Eur J Plant Pathol* 123:367–375

# Chapter 3

## Plasmodiophorids: The Challenge to Understand Soil-Borne, Obligate Biotrophs with a Multiphasic Life Cycle

Sigrid Neuhauser, Simon Bulman, and Martin Kirchmair

**Abstract** Plasmodiophorids are an enigmatic group of obligate biotrophic pathogens of higher plants. Together with their sister group phagomyxids, which infect stramenopiles, they form the monophyletic eukaryote clade phytomyxids. They have long been treated as a basal group of fungi, but recent molecular phylogenies point to a close affiliation with the protozoan phylum Cercozoa. The soil-borne and plant-associated nature of plasmodiophorids as well as their multi-stage life cycle with zoosporic, plasmodial, and resting stages has hindered comprehensive research on this group. Plasmodiophorids cannot be cultured without their hosts, and direct observations of any stage of the plasmodiophorid life cycle are difficult and time-consuming. Molecular techniques provide valuable tools for the identification and monitoring of organisms which are difficult to assess with traditional approaches – such as plasmodiophorids. Several different immunological or nucleic acid-based techniques, and more recently genomic and proteomic approaches have been used to investigate plasmodiophorids, their life style, and their interactions with their host plants. Nonetheless, advances in knowledge about plasmodiophorids provided by molecular techniques are mainly restricted to the few economically important species that cause diseases of agricultural crops. Although their taxa may be well described, the available phylogenies of phytomyxids are rather incomplete, as they include only a few selected species. A main reason for this bias is that most specimens deposited in herbaria are too old, soaked in fixatives or otherwise unavailable for DNA analyses. To fully understand this group of protists, more research on “rare”, under-recorded species is needed.

---

S. Neuhauser and M. Kirchmair  
Institute of Microbiology, Leopold Franzens – University Innsbruck, Technikerstr. 25, 6020  
Innsbruck, Austria  
e-mail: Martin.Kirchmair@uibk.ac.at

S. Bulman  
Plant & Food Research, Private Bag 4704, Christchurch, New Zealand  
Bio-Protection Research Centre, Lincoln University, P.O. Box 84, 7647 Canterbury, New Zealand

In this review, we discuss the impact of molecular techniques on the detection, monitoring, and characterisation of plasmodiophorids. First, we will briefly introduce plasmodiophorid biology and the taxonomic twists and turns the group has taken to reach its current taxonomic position. Development of methods and experimental progress towards better understanding of plasmodiophorids are then sketched, from classical approaches to the recent “-omics” approaches. We will also discuss future implications of molecular methods, which it is hoped will help to improve knowledge about the role of plasmodiophorids within ecosystems.

### 3.1 Introduction

The phytomyxids (plasmodiophorids and phagomyxids) comprise a monophyletic group of eukaryotes which were originally considered as protists, later as fungi, and are now considered as members of the protist supergroup Rhizaria (see below). Partly to avoid specific taxonomic placement, we use the informal term “plasmodiophorids”, as introduced by Braselton (1995), throughout this review.

Plasmodiophorids first came to the attention of scientists and society at the end of the nineteenth century when a severe epidemic of clubroot disease destroyed many of the cabbage crops around St. Petersburg, Russia. The economic loss caused by this disease was tremendous and yet the causative organism or agent was unknown at the time. In 1872, the Russian Gardening Society offered a prize to anyone who could identify the cause of the disease, and who could suggest a control for clubroot. Michail Woronin, a Russian botanist and plant pathologist started his research on the epidemic plague in 1873. A few years later, he described the causative organism – *Plasmodiophora brassicae* – as novel microorganism to the scientific community (Woronin 1877). Woronin observed plasmodia in diseased root parenchyma cells, the metamorphosis of the plasmodia into spores, as well as the hatching of amoebae out of these spores. His discovery of this new organism stimulated interest in this mysterious group of organisms and many plasmodiophorid plant parasites were described during the next decades (Table 3.1).

#### 3.1.1 What are Plasmodiophorids?

Plasmodiophorids are obligate intracellular parasites of green plants. They are characterised by a complex life cycle which will be illustrated by the example of *Pl. brassicae*, the best-studied plasmodiophorid (Fig. 3.1). The life cycle starts with a primary zoospore that attaches to the wall of a root hair of a cruciferous plant. Soon the flagella are retracted and the zoospore encysts. Aist and Williams (1971) demonstrated clearly and in detail that after the primary zoospore attaches to the cabbage root hair, a projectile-like structure (“Stachel”) is formed within a tubular cavity (the “Rohr”) inside the cyst (terminology according to Keskin and Fuchs

**Table 3.1** Plasmodiophorid species on green plants (no sign), \*Oomycetes, †Phaeophyceae, #diatoms, §green algae. y = causing hypertrophies in host plants; n = no hypertrophies visible

Genus	Species	Host species	Hypertrophies	Additional comments
<i>Plasmodiophora</i>	<i>brassicae</i> Woronin	Crucifers	y, roots	–
	<i>halophilae</i> Ferd. & Winge	<i>Halophila</i>	y, petioles	Found only once
	<i>diplantherae</i> (Ferd. & Winge) Ivimey Cook	<i>Diplanthera</i>	y, internodes	Found only once
	<i>fici-repentis</i> Andreucci	<i>Ficus</i>	y, branches	Found only once
	<i>bicaudata</i> Feldmann	<i>Zostera</i>	y, internodes	–
<i>Tetramyxa</i>	<i>maritima</i> Feldm.-Maz.	<i>Triglochinis</i>	y, apex	Found only once
	<i>parasitica</i> K.I. Goebel	<i>Ruppia</i> , <i>Zannichellia</i> , <i>Potamogeton</i>	y	–
	<i>rhizophaga</i> Lihnell	<i>Juniperus</i>	n	Found only once
	<i>triglochinis</i> Molliard	<i>Triglochin</i>	y	no resting spores known
	<i>elaeagni</i> Y. Yendo & K. Takase	<i>Elaeangus</i>	y, roots	Found only once
<i>marina</i> Lipkin & Avidor 1974			–	
<i>Octomyxa</i>	<i>achlyae</i> Couch, J. Leitn. & Whiffen	<i>Achlya</i> *	n	–
	<i>brevilegniae</i> Pend.	<i>Brevilegnia</i> *, <i>Geolegnia</i> *	n	–
<i>Sorosphaera</i>	<i>veronicae</i> J. Schröt.	<i>Veronica</i>	y, shoots	–
	<i>radicalis</i> Ivimey Cook & Schwartz	<i>Poa</i> , <i>Molinea</i> , <i>Catabrosa</i>	y, root hairs	–
	<i>viticola</i> Kirchm., Neuh. & L. Huber	<i>Vitis</i>	n	–
<i>Sorodiscus</i>	<i>callitrichis</i> Lagerh. & Winge	<i>Callitriche</i>	y, shoot	–
	<i>radicicolous</i> Ivimey Cook	<i>Gynandropsis</i>	y	–
	<i>karlingii</i> Ivimey Cook	<i>Chara</i>	y, internodes	–
<i>Membranosorus</i>	<i>cokeri</i> Goldie-Sm.	<i>Pythium</i> *	n	–
	<i>heterantherae</i> Ostenf. & H.E. Petersen	<i>Heteranthera</i>	y, roots	–
<i>Spongospora</i>	<i>subterranea</i> (Wallr.) Lagerh.	Solanaceae	y, fine roots	–
	<i>nasturtii</i> M. W. Dick	<i>Nasturtium</i>	y	–
	<i>campanulae</i> (Ferd. & Winge) Ivimey Cook	<i>Campanula</i>	y, roots	Found only once
<i>Ligniera</i>	<i>cotulae</i> Barrett	<i>Cotula</i>	y	–
	<i>verrucosa</i> Maire & A. Tisson	<i>Veronica</i> other hosts	n	–
	<i>junci</i> (Schwartz) Maire & A. Tisson	<i>Juncus</i> other hosts	n	–
	<i>pilorum</i> Fron. & Gaillat	<i>Poa</i>	n	probably identical with <i>L. junci</i>

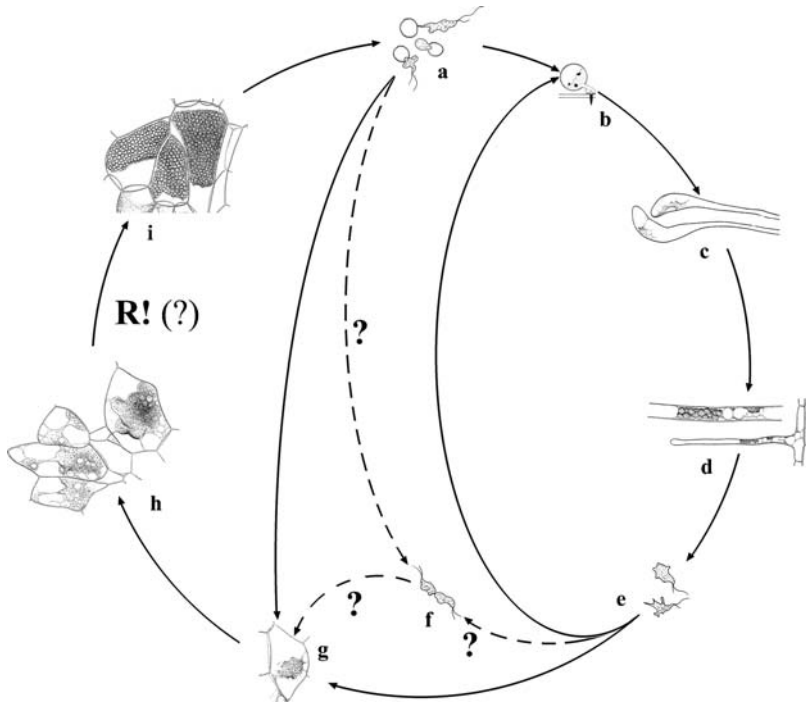
(continued)

**Table 3.1** (continued)

Genus	Species	Host species	Hypertrophies	Additional comments
	<i>isoetes</i> Palm	<i>Isoetes</i>	n	Found only once
	<i>betae</i> (Němec) Karling	<i>Beta</i>	n	probably identical with <i>L. junci</i>
	<i>hypogaeae</i> (Borzi) Karling	Numerous hosts	n	no resting spores known
	<i>plantaginis</i> (Němec) Karling	<i>Plantago</i>	n	no resting spores known
<i>Woronina</i>	<i>polycystis</i> Cornu	Saprolegniaceae*	n	–
	<i>pythii</i> Goldie-Sm.	<i>Pythium</i> *	n	–
	<i>glomerata</i> (Cornu) A. Fisch	<i>Vaucheria</i> <sup>+</sup>	n	–
	<i>aggregata</i> Zopf	<i>Mougeotia</i> <sup>§</sup> <i>Oedogonium</i> <sup>§</sup>	n	Found only once on both hosts only once
	<i>leptolegnia</i> Karling			–
<i>Polymyxa</i>	<i>graminis</i> Ledingham	Different grasses	n	–
	<i>betae</i> Keskin	Cenopodiaceae	n	–
<i>Phagomyxa</i>	<i>algarum</i> Karling	<i>Pylaiella</i> <sup>+</sup> <i>Ectocarpus</i> <sup>+</sup>	n	Found only once
	<i>chattonii</i> (P.A. Dang.) Karling	–	–	–
	<i>bellerocheae</i> Schnepf	<i>Bellerochea</i> <sup>#</sup>	n	–
	<i>odontellae</i> Kühn, Schnepf & Bulman	<i>Odontella</i> <sup>#</sup>	n	–
<i>Maullinia</i>	<i>ectocarpus</i> I. Maier, E.R. Parodi, Westermeier & D.G. Müll.	<i>Ectocarpus</i> <sup>+</sup>	–	–

1969). The “Rohr” is evaginated to form a bulbous adhesion which is attached to the host cell wall. The Stachel passes down the “Rohr”, punctures the host wall and then, within 1 s, an amoeboid infection unit (myxamoeba) is injected into the root hair. The total time from adhesion formation to host penetration is about 1 min (Aist and Williams 1971). Inside the root hair, the myxamoeba develops into a multinucleate plasmodium which cleaves into a sporangiosorus consisting of numerous zoosporangia. Three to sixteen secondary zoospores hatch from each zoosporangium (Ingram and Tommerup 1972). According to Tommerup and Ingram (1971), two secondary zoospores undergo plasmogamy and the binucleate spore infects the roots of the host, but such a fusion of zoospores has not been confirmed by other authors studying the plasmodiophorid life cycle (Ludwig-Müller and Schuller 2008). Nevertheless, there is consensus that soon after the infection by secondary zoospores, multinucleate secondary plasmodia are formed in a process accompanied by pronounced cell division and the formation of hypertrophic cells of the host plant. At this time the typical symptoms of clubroot disease become obvious. During further development, the plasmodium cleaves





**Fig. 3.1** Life cycle of *Plasmodiophora brassicae*: (a) Primary zoospores hatching out of resting spores. (b) Encysted zoospore injects its protoplast into the root hair by the help of a special extrusosome (“Rohr”) and a projectile-like structure (“Stachel”). (c) Primary plasmodia in root hairs. (d) zoosporangia in root hairs. (e) Secondary zoospores infect cabbage root or (f) undergo karyogamy according to Ingram and Tomerup (1971); but plasmogamy could not be confirmed by other authors. (g)–(h) Secondary plasmodia are developed. (i) Formation of resting spores. According to Ingram and Tomerup (1971) karyogamy and meiosis (R!) take place prior to resting spore formation. Alternative “microcycles” may occur: Mithen and Margath (1992) concluded that secondary plasmodia may also be developed from primary zoospores. Naiki et al. (1984) demonstrated that secondary zoospores can re-infect root hairs and produce further zoosporangia. (a) and (c)–(i) according to Woronin 1878; (b) according to Aist and Wiliams 1971

into numerous resting spores. These resting spores can survive in soil for at least 7–8 years (Jørstad 1923; Nielsen 1933 cited in Karling 1968). The formation of primary zoospores closes the cycle. Recent studies provide evidence that the life cycle may be more complicated. Naiki et al. (1984) demonstrated that secondary zoospores can re-infect root hairs and produce further zoosporangia. Mithen and Magrath (1992) concluded that secondary zoospores may not be necessary to develop secondary plasmodia. Myxamoeba derived from primary zoospores may migrate from root hairs to cells of the cortical tissue and form secondary plasmodia and galls. This view was supported by observations by Narisawa et al. (1996) who successfully infected the roots with single resting spores and detected plasmodia in the cortical root cells. However, the formation of resting spores and therefore a

complete life cycle could be initiated only when plants were inoculated with a dikaryotic or two monokaryotic resting spores (Narisawa and Hashiba 1998).

Although the life cycle of *Pl. brassicae* is now relatively well known, there is still a lack of knowledge especially with respect of karyogamy. Moreover, the life cycles of other plasmodiophorids differ in some degree or are not fully known. Braselton (2001) summarised the current knowledge of sexuality in plasmodiophorids as “largely indirect and presumptive”. Seven years later, we know only a little more about this topic. A comprehensive knowledge on the spatiotemporal distribution of the stages of the plasmodiophorids life cycle would provide strategies for identification and detection of these important, plant-associated organisms.

### 3.1.2 *The Plasmodiophorids in the Tree of Life*

Since the description of the first plasmodiophorid, their taxonomic position remained unresolved for a considerable time. When Woronin established the genus *Plasmodiophora*, he proposed an affiliation to the protists in the sense of Haeckel and considered them as the simplest group of the Myxomycetes (Woronin 1878). Historically, Myxomycetes and therefore the plasmodiophorids were considered as fungi. In his monograph on the parasitic slime-moulds, Cook (1932) discussed them as “some of the simplest, if not the most primitive, parasitic fungi known”. There was much speculation on the evolution of plasmodiophorids in the pre-molecular era. Mycologists placed the plasmodiophorids in the division Mastigomycota with other flagellate “fungi” (Alexopoulos and Mims 1979). The presence of chitin in the cell wall of resting spores led to the conclusion that plasmodiophorids may be related to Chytridiomycetes (Buczacki 1983). On the basis of the ultrastructure of zoospores, Barr (1992) reverted to the view of Woronin (1878) and classed the plasmodiophorids within the Protozoa. The transitional region of the plasmodiophorid flagellum was found similar to that of “many protists such as the amoebflagellate *Naegleria gruberi*”, a species belonging to the Heterolobosea classified among the discicristates (Keeling et al. 2008). Cavalier-Smith (1993) placed the order Plasmodiophorida in the class Phytomyxea, subphylum Proterozoa, phylum Opalozoa, where he grouped protists with tubular mitochondrial cristae that lack plastids, cortical alveoli, and tubular ciliary hairs.

The progress of DNA sequencing has allowed a more profound classification of the plasmodiophorid plant parasites. Molecular phylogenies based on 18S ribosomal rDNA data confirmed that plasmodiophorids were not related to fungi, but no linkage with any other eukaryotic group was found (Castlebury and Dormier 1998; Ward and Adams 1998). Using 18S rDNA data, Cavalier-Smith and Chao (1996/1997) concluded that the Plasmodiophorida are most closely allied with a group containing chlorarachneans and sarcomonads and placed them in the class Phytomyxea within a phylum temporarily called Rhizopoda. This phylum was then renamed Cercozoa (Cavalier-Smith 1998, 2000; Cavalier-Smith and Chao 2003).

Protein sequence data indicate that the closest relatives of Cercozoa are the Foraminifera (Keeling 2001). This relationship was confirmed by Archibald and Keeling (2004) who analysed actin and ubiquitin protein sequences of plasmodiophorids. They found a single amino acid residue insertion at the functionally important processing point between ubiquitin monomers, at the same position in which an otherwise unique insertion exists in the cercozoan and foraminiferan proteins. It was concluded that plasmodiophorids are related to Cercozoa and Foraminifera, although the relationships among these groups remained unresolved. Nikolaev et al. (2004) calculated SSU and actin phylogenies of amoeboid eukaryotes. They found that the Phytomyxea was a sister group to a clade consisting of Phaeodarea, core Cercozoa, and Desmothoracida. In 2005, a revision of the classification of unicellular eukaryotes was suggested (Adl et al. 2005). A hierarchical system without formal rank design (class, order, etc.) was adopted. According to this scheme the Phytomyxea are embedded within the Cercozoa in the super-group Rhizaria. It should be a task of future research to resolve the open questions on the “true” alliance of plasmodiophorids.

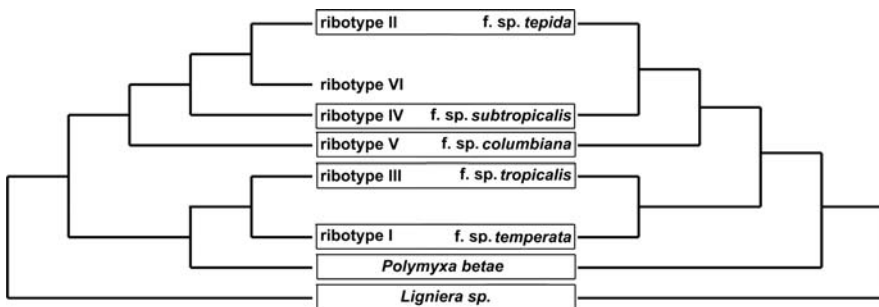
### 3.1.3 Phylogenetic Relationships Within the Plasmodiophorids

In his monograph of the “Plasmodiophorales”, Karling (1968) accepted 11 genera and 35 species (plus three varieties which are raised to species level in current publications). Since then, six new species and one new genus of phytomyxids were described (Table 3.1). Only eight of these 44 phytomyxid species were included in phylogenetic DNA analyses: the plasmodiophorids *Pl. brassicae*, *Polymyxa graminis* Ledingham, *Px. betae* Keskin, *Spongospora subterranea* (Wallr.) Lagerh., *Sp. nasturtii* M.W. Dick, *Sorosphaera veronicae* J. Schröt., and the phagomyxids *Phagomyxa bellerocheae* Schnepf and *Ph. odontellae* Kühn, Schnepf & Bulman. Archibald and Keeling (2004) included five sequences from a total of three plasmodiophorid species in their phylogenetic study based on actin protein sequences. The plasmodiophorid clade was divided into two sub-clades. One was formed by *Sp. subterranea* and *So. veronicae* and a second clade consisted of sequences of two *Pl. brassicae* isolates. The most comprehensive phylogeny was based on 18S rDNA sequences of eight phytomyxid species (Bulman et al. 2001). In that study, two major clades of phytomyxids were found: the plasmodiophorids parasiting green plants and the phagomyxids parasiting diatoms. The two clades were designated as “orders” according to zoological nomenclature (Phagomyxida, Plasmodiophorida). The phagomyxids consisted of two *Phagomyxa* species (*Ph. bellerocheae*, *Ph. odontellae*) and the plasmodiophorids consisted of *Sp. subterranea*, *Sp. nasturtii* (= *subterranea* f. sp. *nasturtii*), *Pl. brassicae*, *So. veronicae*, *Px. betae*, and *Px. graminis*. A subclade comprising *So. veronicae* and the two *Polymyxa*-species was supported with bootstrap values of 100% in neighbour joining and parsimony analysis.

Although little is known about the “deep” roots of phytomyxid phylogeny, there are some species whose intraspecific phylogeny has been studied in some detail. *Polymyxa* species are only distinguishable by their host preferences. To resolve whether *Px. betae* and *Px. graminis* are distinct taxonomic units, restriction analysis of the ITS1-5.8S-ITS2 ribosomal rDNA region was applied by Ward et al. (1994). This study confirmed that *Px. betae* is distinct from *Px. graminis*. Moreover, the latter species could be divided into two subgroups (ribotypes). A third ribotype of *Px. graminis* was found on *Sorghum* plants in India (Ward and Adams 1998). The number of ribotypes increased to six when African and Japanese *Polymyxa* samples were included in the phylogenetic analyses (Ward et al. 2005b). Legrève et al. (2002) divided *Px. graminis* into five special forms (*formae speciales*) analysing ITS sequences of a similar set of strains. Legrève and co-workers (2002) argued that, in addition to sequence data, these special forms can be differentiated by specific combination of host range and temperature requirements. Although the f. *speciales* of Legrève et al. (2002) correspond to the ribotypes of Ward et al. (2005b; Table 3.2, Fig. 3.2), there is no consensus on the naming of these taxa. For a

**Table 3.2** Intraspecific taxa in *Polymyxa graminis* according to Ward et al. (2005a, b) and Legrève et al. (2002). Genbank accession numbers for ITS1-5.8S-ITS2 rDNA sequences used in these studies are given. Sequences used in both studies are printed in bold

<i>Polymyxa graminis</i> ribotype (Ward et al. 2005)		<i>Polymyxa graminis formae speciales</i> (Legrève et al. 2002)	
ribotype I	Y12824	f. sp. <i>temperata</i>	AJ311572, AJ311573, AJ311574
ribotype II	<b>Y12826</b>	f. sp. <i>tepida</i>	<b>Y12826</b>
ribotype III	<b>AJ311580, Y12825</b>	f. sp. <i>tropicalis</i>	AJ311575, AJ311576, <b>AJ311580, Y12825</b>
ribotype IV	<b>AJ311577, AJ311579</b>	f. sp. <i>subtropicalis</i>	<b>AJ311577, AJ311578, AJ311579</b>
ribotype V	<b>AJ010424, AM075820, AM075821, AM075822</b>	f. sp. <i>colombiana</i>	<b>AJ010424</b>
ribotype VI	AM075823		



**Fig. 3.2** Cladograms of intraspecific taxa within *Polymyxa graminis* according to Ward et al. (2005b) and Legrève et al. (2002). Ward et al. (2005b) described ribotypes which correspond to *formae speciales* suggested by Legrève et al. (2002)

general acceptance of the “new” infraspecific taxonomic units, more data from different genes and more isolates should be analysed.

### 3.1.4 Economic Importance of Plasmodiophorids

A small number of plasmodiophorids are quite well studied, especially plasmodiophorids which cause plant diseases and/or have economic significance as vectors of plant viruses. Loss caused by clubroot disease (*Pl. brassicae*; Figs. 3.3 and 3.4) was estimated to be approximately 10% of all cruciferous crops in Australia (Faggian et al. 1999). The hypertrophic roots of infested plants are a sink for sugars and therefore the clubbed roots lead to stunted growth of the plants. As further example of the economic impact of clubroot disease, in Nepal (province of Palung) the economic loss was estimated at US\$ 1.4 million in 2004 and 2005 (Timila et al. 2008). Another plasmodiophorid of economic significance is *Sp. subterranea*, the causal agent of powdery scab of potatoes (Figs. 3.5 and 3.6). Powdery scab lesions are usually small, circular, and uniform in size and are surrounded by a fringe of potato skin when mature. As the tuber skin over the pustules ruptures, a shallow depression filled with a brown, powdery mass of spores and broken-down tissue is exposed. Infected tubers are predisposed to other maladies such as *Fusarium* dry rot during storage. Moreover, *Sp. subterranea* can transmit the potato mop-top virus (PMTV). Foliar symptoms of PMTV include yellow rings, V shape markings, and blotches, especially on the lower leaves. Stems can also be stunted, giving a “mop-top” effect. Tuber symptoms are called “spraing”, rustbrown discoloration, in the form of arcs or rings and flecks that appears with internal rust-coloured spots on tubers (reviewed by Merz 2008).

Rhizomania (lit. “crazy root” or “root madness”) is a serious disease of sugarbeet caused by the beet necrotic yellow vein virus (BNYVV) which is transmitted by the plasmodiophorid *Px. betae* (reviewed by Varrelmann 2007). Root symptoms include a mass of fine, hairy secondary roots giving the taproot a beard-like appearance. This reduces sugar yield because tonnage or sugar content or both are reduced. Losses can amount to 50–70% of root weight and 2–4% or more of sugar content (EPPO 1997). *Px. graminis* can cause significant yield reductions in cereal crops. Like *Px. betae*, the plasmodiophorid itself does not obviously harm its host, but it can acquire and transmit a range of plant viruses (reviewed by Kanyuka et al. 2003). The soil-borne wheat mosaic virus (SBWMV), for example, causes serious diseases in many cereal species, including winter wheat, durum wheat, barley, rye, and triticale (Brakke 1971). Losses of 40–50% occur in infected areas of commercial fields in Florida, USA (Kucharek and Walker 1974). A complete life cycle of *Px. graminis* has only been observed in monocotyledonous plants, but can be a vector for the Indian Peanut Clump Virus as well (IPCVC; Ratna et al. 1991). The dicot “groundnut” serves only as an intermediate host and is not a “natural” reservoir for the plasmodiophorid vector. Peanut clump viruses are among the most damaging soil-borne pathogens of

groundnut, causing crop losses estimated at over US\$38 million per year world-wide (Delfosse et al. 1999).

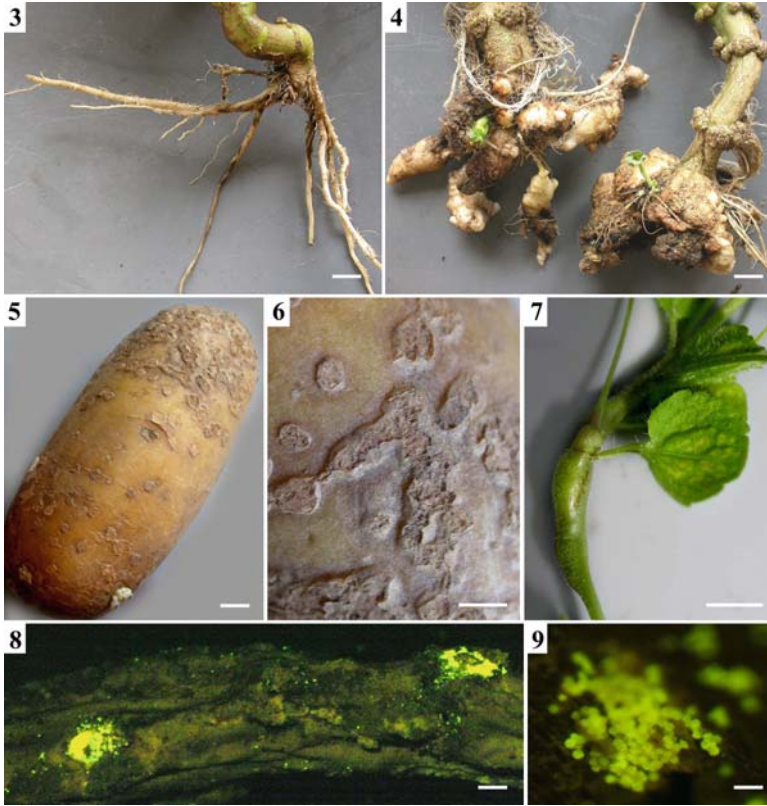
## 3.2 Experimental Strategies to Detect and Monitor Plasmodiophorids

### 3.2.1 Direct Observations, Bioassays, and Bait Tests

“Easy” direct observations are limited to those plasmodiophorids that cause distinct disease symptoms. Hypertrophies caused by some plasmodiophorid species (Table 3.1) can be easily observed with the naked eye. Examples are the clubbed roots of cruciferous plants (Fig. 3.4) or the shoot galls of *Veronica* spp. caused by *So. veronicae* (Fig. 3.7). The lesions on potato tubers caused by *Sp. subterranea* are also easy to recognise (Figs. 3.5 and 3.6). But not all plasmodiophorids cause hypertrophies, so for those without obvious symptoms on their host plants, more sophisticated monitoring methods are needed. Sporosori of *So. viticola* exhibit a characteristic green–yellow autofluorescence (Fig. 3.8 and 3.9) at 450–490 nm. This autofluorescence has been used to screen grapevine roots for its presence and to assess the distribution of this plasmodiophorid in commercial vineyards (Huber et al. 2006). Detection methods for identifying plasmodiophorids which do not cause hypertrophies on the host plant or exhibit autofluorescence – like *Px. graminis* or *L. junci* – are restricted to microscopical screenings of plant roots.

One strategy for the detection of fungal or protozoan pathogens in soils and composts are bioassays or bait tests (Ciafardini and Marotta 1989). These techniques are particularly useful for detecting non-culturable, obligate parasites (Noble and Roberts 2004). Sensitive indicator plants are grown in the test material (e.g. soil), and the presence of the pathogen is indicated by the development of typical disease symptoms on the indicator plants. The benefits of bioassays are that the viability and pathogenicity are indicated as well as the presence of the pathogen. Drawbacks are that bioassays can take several weeks and can be hampered by low inoculum levels or by microbial interactions (Christensen et al. 2001). Nevertheless, bioassays and bait tests are standard procedures in different national and international regulations. For example, the German “Ordinance on Biowaste” (BioAbfV) regulates a testing for *Pl. brassicae* of biowastes which should be spread on agricultural, silvicultural, or horticultural land. The aim of this regulation is to minimise the risk of spreading viable *Pl. brassica* resting spores. The method is based on the work of Knoll et al. (1980) and Bruns et al. (1994). To evaluate the efficacy of composting on removing pathogenic propagules, meshbags containing *Plasmodiophora* root galls mixed with compost are incorporated into biowaste. After composting, the samples are mixed with sterilised sand and peat. Test plants (*Brassica juncea* variety “Vitasso”) are potted into this mixture, and then incubated for 5 weeks. Affected plants are counted and the root gallings are graded. An infection index can be calculated.





**Figs. 3.3–3.9** Host symptoms of plasmodiophorid infestations. **Figs. 3.3–3.4:** Clubroot disease on cauliflower (3: healthy roots, 4: clubbed roots) caused by *Plasmodiophora brassicae* (bars = 1 cm). **Figs. 3.5–3.6:** Powdery scab of potatoes caused by *Spongospora subterranean* (5: bar = 1 cm; 6: bar = 5 mm). **Fig. 3.7:** Shoot gall on *Veronica persica* induced by *Sorosphaera veronicae* (bar = 5 mm). **Figs. 3.8–3.9:** Epifluorescence of sporangia of *Sorosphaera viticola* in vine roots at 450–490 nm (8: bar = 1 mm; 9: bar = 20  $\mu$ m)

### 3.2.2 Molecular Approaches

Methods based on molecular components of cells have opened new possibilities in the study of plasmodiophorids. These methods allow the detection of plasmodiophorids in host tissue and in environmental samples such as soil or water, which is of great interest for scientists who want to understand the parasite's life cycle. The methods also permit risk assessments to be made, which are important for breeders and growers of susceptible crops who face economic losses either from the symptoms caused by plasmodiophorids or the viruses they transmit. Many nucleic acid-based and immunological methods have been developed to facilitate an easy, fast, and highly sensitive detection of plasmodiophorids. These can be used for

large-scale screenings for infected plants in plantations or for pre-planting tests of soils for the presence of the pathogen. Different molecular approaches to identify plasmodiophorids, including their implementation in the field, will be discussed in the following sections.

### 3.2.2.1 Antibody-Based Methods

Immunological test methods are quick and detect mainly living material, but the laborious development of assays and possible cross-reactions with related species or the host plant are serious drawbacks (Ward et al. 2004a, b). The development of antibodies and sensitive test systems which are ideally applicable in the field requires considerable optimisation. This process is expensive compared with the development of nucleic acid-based methods for the identification of plasmodiophorids. Although dip-stick tests or lateral flow devices could facilitate on-site testing, ELISA (enzyme linked immunosorbent assay) protocols are most commonly used, probably because of their wide application in plant virus detection (Merz et al. 2005): the detection of plasmodiophorid parasites and the viruses they transmit can be done with the same equipment.

The obligate biotrophic and endophytic nature of plasmodiophorids makes it very important, but difficult, to avoid cross-reactions, especially with the host plant. Even if protocols for the purification and accumulation of plasmodiophorid resting spores are used, the resulting preparations are never completely free of contaminating plant material or other microorganisms (Wakeham and White 1996; Walsh et al. 1996; Delfosse et al. 2000; Qu and Christ 2006a). Two types of antibodies are used: polyclonal antibodies (a mixture of antibodies; usually obtained from immunised animals) and monoclonal antibodies (a specific antibody against a protein or component of the cell). Polyclonal antibodies have been used in ELISA tests for *Sp. subterranea* (Harrison et al. 1993; Wallace et al. 1995; Walsh et al. 1996; Merz et al. 2005); *Px. betae* (Walsh et al. 1996; Mutasa-Göttgens et al. 2000; Kingsnorth et al. 2003a), *Px. graminis* (Delfosse et al. 2000) and *Pl. brassicae* (Wakeham and White 1996). All authors reported a (semi-)quantitative detection of resting spores in plant material and soil samples. All antibodies used were reported to be highly specific for the targeted pathogen; only between the two *Polymyxa* species did some cross-reactions occur (Delfosse et al. 2000). Besides ELISA-tests, polyclonal antibodies for *Pl. brassicae* were used in western blots, dot blots, dip-sticks, and indirect immunofluorescence microscopy (Arie et al. 1988; Wakeham and White 1996).

More specific, but also more laborious, is the production of monoclonal antibodies. An ELISA method based on monoclonal antibodies against a glutathione-S-transferase (GST) specific for *Px. betae* was established (Mutasa-Göttgens et al. 2000; Kingsnorth et al. 2003a). The GST cDNA was cloned and expressed, then purified and used for antibody production. Monoclonal antibodies were used with varying success for *Sp. subterranea*: Wallace et al. (1995) derived five different monoclonal antibodies recognising zoospores and plasmodia but not cytosori. They



observed a cross-hybridisation with *Px. graminis*, whereas Merz et al. (2005) reported the production of a highly sensitive and specific antibody detecting all stages of the life cycle.

In plant pathology, immunological tests are especially popular to detect plant viruses. As some viruses need a plasmodiophorid as vector to infect plants, the presence of the virus gives indirect evidence of the presence of the plasmodiophorid. For some of the viruses transmitted by plasmodiophorids, serological detection methods are available. An overview is published at DPVweb (see Description of Plant Viruses; Adams and Antoniw 2006, <http://www.dpvweb.net/> and the references therein).

### 3.2.2.2 Nucleic Acid-Based Methods

Nucleic acid-based detection methods were quickly appreciated by plant pathologists dealing with plasmodiophorids (Ward et al. 1994; Buhariwalla et al. 1995). The supplementation or substitution of classical observation methods with PCR-based detection methods for the first time allowed large-scale screening and epidemiological studies (Legrève et al. 2000; Legrève et al. 2003; Legrève et al. 2005; Qu and Christ 2006b). However, the obligate biotrophic lifestyle of the plasmodiophorids remains problematic. Plasmodiophorids cannot grow in the absence of their particular host plants and if it is possible to establish a dual system plant–pathogen, it is virtually impossible to keep it without any environmental contamination. Against this background, it is no surprise that, again, only those few plasmodiophorid species causing plant diseases or transmitting plant viruses have been the focus of DNA detection research. During recent years, emphasis has been placed on the development of highly specific detection methods and species-specific primers for the plasmodiophorid crop pathogens (see Table 3.3 and the references therein).

Most plasmodiophorid DNA-sequences are available from the ITS1-5.8S-ITS2 region of the rDNA tandem repeat. The majority of the species-specific primers have been designed from the highly variable spacers in this region; as a multi-copy gene, the ribosomal repeat is relatively easy to access (Fig. 3.10, Ward and Adams 1998; Bell et al. 1999; Faggian et al. 1999; Bulman et al. 2001; Wallenhammar and Arwidsson 2001; Down and Clarkson 2002; Legrève et al. 2003; Meunier et al. 2003; van de Graaf et al. 2003; Ward et al. 2004a, b, 2005a, b). There were also attempts to find other, unique plasmodiophorid regions for PCR-based detection. For *Pl. brassicae*, a single copy gene unique to the pathogen was used (Ito et al. 1997, 1999; Wallenhammar and Arwidsson 2001). The single-copy GST-gene (Mutasa-Göttgens et al. 2000) and another single copy gene (Genbank accession number X83745) were used for the detection of *Px. betae* (Mutasa et al. 1995; Mutasa et al. 1996; Kingsnorth et al. 2003b). Using the latter gene, a nested PCR (nPCR) method and a single-tube nested PCR (stnPCR) method were developed to identify *Px. betae* without the risk of a co-amplification of host DNA (Ciafardini and Marotta 1989; Mutasa et al. 1995; Mutasa et al. 1996). The RNA transcript of

**Table 3.3** PCR primers used for the detection of plasmidophorids. Abbreviations of "Reaction type": PCR = standard PCR, qPCR = real-time PCR, nPCR = nested PCR, stmPCR = single-tube-nested PCR, mRT-PCR = multiplex reverse transcriptase PCR

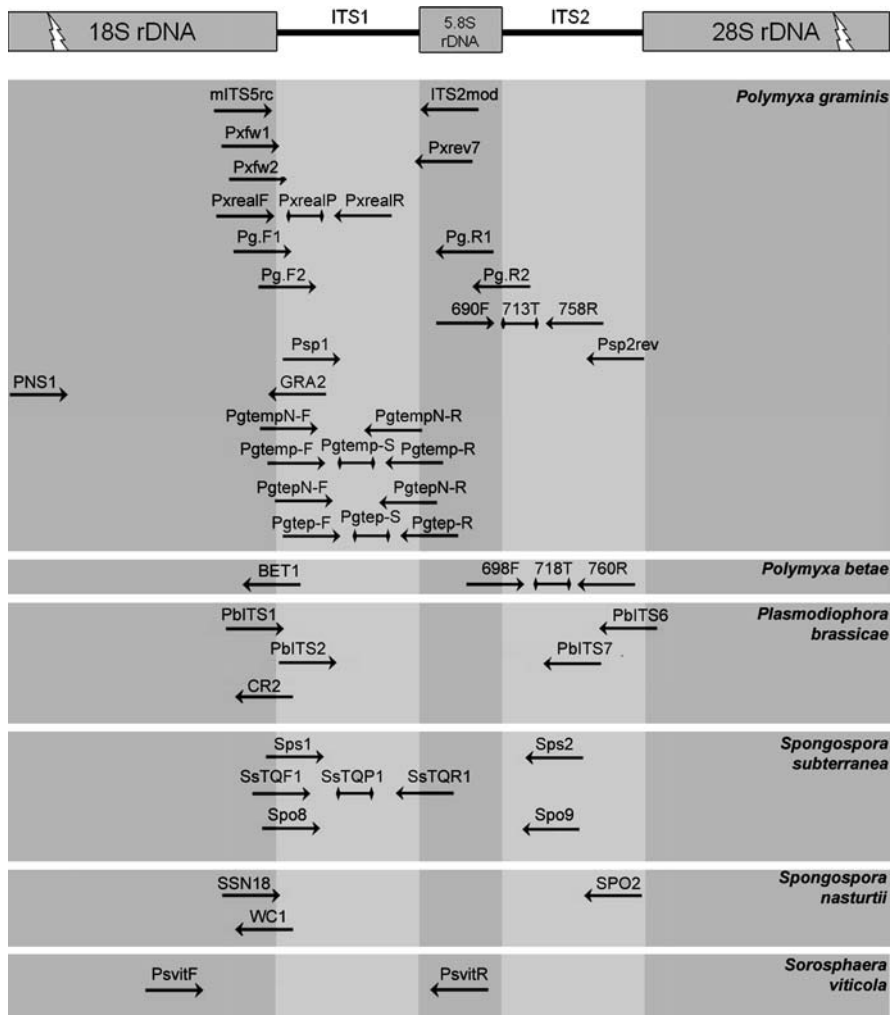
Taxa	Gene	Primer	Primer sequence (5'-3')	Reaction type	Reference
Plasmidophorids	rDNA	PNS1	gTT ATC Tgg TTg ATC CTg CC	PCR	Bulman et al. (2001)
<i>Pl. brassicae</i>	D85819	PBTZS-2	CCg AgT TCg CgT CAg CgT gA	stmPCR	Ito et al. (1997)
<i>Pl. brassicae</i>	D85819	PBTZS-3	CCA CgT CgA TCA CgT TgC AAT	stmPCR	Ito et al. (1997)
<i>Pl. brassicae</i>	D85819	PBTZS-4	gCT ggC gTT gAT gTA CTg gAA TT	stmPCR	Ito et al. (1997)
<i>Pl. brassicae</i>	D85819	PBAW-10	CCC Cgg ggA TCA CgA TAA ATA ACA	nPCR	Wallenhammar and Arwidsson (2001)
<i>Pl. brassicae</i>	D85819	PBAW-11	ggA Agg CCg CCC Agg ACT ACC	nPCR	Wallenhammar and Arwidsson (2001)
<i>Pl. brassicae</i>	D85819	PBAW-12	gCC ggC CAg CAT CTC CAT	nPCR	Wallenhammar and Arwidsson (2001)
<i>Pl. brassicae</i>	D85819	PBAW-13	CCC CAg ggT TCA CAg CgT TCA A	nPCR	Wallenhammar and Arwidsson (2001)
<i>Pl. brassicae</i>	rDNA	PbITS1	ACT TgC ATC gAT TAC gTC CC	nPCR	Faggian et al. (1999)
<i>Pl. brassicae</i>	rDNA	PbITS2	ggC ATT CTC gAg ggT ATC AA	nPCR	Faggian et al. (1999)
<i>Pl. brassicae</i>	rDNA	PbITS6	CAA CgA gTC AgC TTg AAT gC	nPCR	Faggian et al. (1999)
<i>Pl. brassicae</i>	rDNA	PbITS7	TgT TTC ggC TAg gAT ggT TC	nPCR	Faggian et al. (1999)
<i>Pl. brassicae</i>	rDNA	CR2	TAT GCC gCA gCA AAg CTC	PCR	Bulman et al. (2001)
<i>Px. betae</i>	GST	male	gAC ATT GCC gCT CTg ACT T	qPCR	Kingsnorth et al. (2003a, b)
<i>Px. betae</i>	GST	female	AATg AgC TgT TgC CTT ATT TTg gA	qPCR	Kingsnorth et al. (2003a, b)
<i>Px. betae</i>	GST	probe	CAA gCA ggC TCA CgC TgC CAT g	qPCR Probe	Kingsnorth et al. (2003a, b)
<i>Px. betae</i>	rDNA	698F	CAT gTC ggC AAC CgA AAg T	qPCR	Ward et al. (2004b)
<i>Px. betae</i>	rDNA	760R	Tgg TTC ggG CgCC CAT	qPCR	Ward et al. (2004b)
<i>Px. betae</i>	rDNA	718 T	Cgg ATT CTT ggA CgC AAT CCG C	qPCR Probe	Ward et al. (2004b)
<i>Px. betae</i>	rDNA	BET1	CgA ATC gAC TCT CAT TgT CC	PCR	Bulman et al. (2001)
<i>Px. betae</i>	X83745	Pb-5a	CAG ggg CAg ACg gAT CgC Ag	stmPCR	Mutasa et al. (1996)
<i>Px. betae</i>	X83745	Pb-5b	CgT CgA gCg CAg TTC TTg gC	stmPCR	Mutasa et al. (1996)
<i>Px. betae</i>	X83745	Pb-6a	AgA TgA ggA TgT CAg TCA gg	stmPCR	Mutasa et al. (1996)
<i>Px. betae</i>	X83745	Pb-4b	CTA TgT ggC AAA CCC AAg	stmPCR	Mutasa et al. (1996)
<i>Px. betae</i>	X83745	Pb-3a	ACg ATg gAC gAC TAT TgA ggg g	nPCR	Mutasa et al. (1995)

<i>Px. betae</i>	X83745	Pb-3b	gCA gCC TAG TCA CAA ATg gCg	nPCR	Mutasa et al. (1995)
<i>Px. betae</i>	X83745	Pb-N3a/2	Tgg Agg AAA ggg	nPCR	Mutasa et al. (1995)
<i>Px. betae</i>	X83745	Pb-N3b/2	ACT TgT CAg TTg CC	nPCR	Mutasa et al. (1995)
<i>Px. betae</i>	X83745	PB4for	CAC ACg CCT gAA ATC ATC TAA C	mRT-PCR	Meunier et al. (2003)
<i>Px. betae</i>	X83745	PB4rev	gAT ggC CAA TT CTT ACA C	mRT-PCR	Meunier et al. (2003)
<i>Px. graminis</i>	rDNA	Pxfwd1	CTg Cgg AAg gAT CAT TAG CgTT	PCR	Ward and Adams (1998)
<i>Px. graminis</i>	rDNA	Pxfwd2	ggA Agg ATC ATT AgC gTT gAA T	PCR	Ward and Adams (1998)
<i>Px. graminis</i>	rDNA	Pxrev7	gAg gCA TgC TTC CAg ggC TCT	PCR	Ward and Adams (1998)
<i>Px. graminis</i>	rDNA	PxRealF	CgT CgC TTC TAC CgA TTg gT	qPCR	Ward et al. (2005a, b)
<i>Px. graminis</i>	rDNA	PxRealR	CCT TgT TAC gAC TTC TTC TTC CTC	qPCR	Ward et al. (2005a, b)
			TAG T		
<i>Px. graminis</i>	rDNA	PxRealP	CCg gTg AAC AAT Cg	qPCR Probe	Ward et al. (2005a, b)
<i>Px. graminis</i>	rDNA	690F	CAG CCC gCA TgC ATC TC	qPCR	Ward et al. (2004b)
<i>Px. graminis</i>	rDNA	758R	Cgg ATT gTC gTT CCA AgA A	qPCR	Ward et al. (2004b)
<i>Px. graminis</i>	rDNA	713 T	TCA gCA CgT CCA AAg TCC AT	qPCR Probe	Ward et al. (2004b)
<i>Px. graminis</i>	rDNA	GRA2	gTT CCA AgA ACC CgA Tgg AC	PCR	Bulman et al. (2001)
<i>Px. graminis</i> f.sp. <i>temperata</i>	rDNA	PgtempN-F	AgC gTT gAA TTTg gTC TTg gT	PCR	Vaianopoulos et al. (2005)
<i>Px. graminis</i> f.sp. <i>temperata</i>	rDNA	PgtempN-R	TAG CCA ATT CTC CCg AgT TC	PCR	Vaianopoulos et al. (2005)
<i>Px. graminis</i> f.sp. <i>temperata</i>	rDNA	Pgtemp-F	ggA gTT gCA TCC CgC ATg	qPCR	Vaianopoulos et al. (2005)
<i>Px. graminis</i> f.sp. <i>temperata</i>	rDNA	Pgtemp-R	CgCC ATg ACg gAT TgT CgT T	qPCR	Vaianopoulos et al. (2005)
<i>Px. graminis</i> f.sp. <i>temperata</i>	rDNA	Pgtemp-S	AgT CAG CAC gTC gC CAA AgT CCA	qPCR Probe	Vaianopoulos et al. (2005)
<i>Px. graminis</i> f.sp. <i>tepicida</i>	rDNA	PgtepN-F	TAg CgT TgA ATg gTT gT gC	PCR	Vaianopoulos et al. (2005)
<i>Px. graminis</i> f.sp. <i>tepicida</i>	rDNA	PgtepN-R	TTC gAC TTT AgC CAC CgT TT	PCR	Vaianopoulos et al. (2005)
<i>Px. graminis</i> f.sp. <i>tepicida</i>	rDNA	Pgtep-F	AAT gTg gAT CgT CTC TgT TgC Tg	qPCR	Vaianopoulos et al. (2005)
<i>Px. graminis</i> f.sp. <i>tepicida</i>	rDNA	Pgtep-R	CAC CT TTT gAT CCA ATT CgT gAA	qPCR	Vaianopoulos et al. (2005)
<i>Px. graminis</i> f.sp. <i>tepicida</i>	rDNA	Pgtep-S	Cgg gAT gAg ACg CCC TCg Tgg Tgg	qPCR Probe	Vaianopoulos et al. (2005)
<i>Px. graminis</i> ribotype II	rDNA	Pg.F2	ATg Tgg ATC gTC TCT gTT gCT gGA	PCR	Ward et al. (2005a, b)
<i>Px. graminis</i> ribotype II	rDNA	Pg.R2	CCT CAT CTg AgA TCT TgC CAA gT	PCR	Ward et al. (2005a, b)
<i>Px. graminis</i> ribotype I	rDNA	Pg.F1	AAC ATg Tgg ATT gTg ggc TAT gTg	PCR	Ward et al. (2005a, b)
<i>Px. graminis</i> ribotype I	rDNA	Pg.R1	AAC TCC CAT TCT CCA CAA CgC AA	PCR	Ward et al. (2005a, b)
<i>Polymyxa</i> spp.	rDNA	ITS2mod	gCT gCg TTC TTC CAT CgT TgT gg	PCR	Ward and Adams (1998)
<i>Polymyxa</i> spp.	rDNA	mITS5rc	CCT ACg gAA ACC TTg TTA Cg	PCR	Ward and Adams (1998)

(continued)

Table 3.3 (continued)

Taxa	Gene	Primer	Primer sequence (5'-3')	Reaction type	Reference
<i>Polymyxa</i> spp.	rDNA	Psp1	TAg ACg CAg gTC ATC AAC CT	PCR	Legrève et al. (2003)
<i>Polymyxa</i> spp.	rDNA	Psp2rev	Agg gCT CTC gAA AgC gCA A	PCR	Legrève et al. (2003)
<i>Sp. subterranea</i>	rDNA	SsTQF1	CCg gCA gAC CCA AAA CC	qPCR	van de Graaf et al. (2003)
<i>Sp. subterranea</i>	rDNA	SsTQR1	Cgg gCg TCA CCC TTC A	qPCR	van de Graaf et al. (2003)
<i>Sp. subterranea</i>	rDNA	SsTQPI	CAG ACA ATC gCA CCC Agg TTC TCA Tg	qPCR Probe	van de Graaf et al. (2003)
<i>Sp. subterranea</i>	rDNA	Sps1	CCT ggg TgC gAT TgT CTg TT	PCR	Bell et al. (1999)
<i>Sp. subterranea</i>	rDNA	Sps2	CAC gCC AAT CCT TAg AgA Cg	PCR	Bell et al. (1999)
<i>Sp. subterranea</i>	rDNA	Spo8	CTg ggT gCg ATT gTC TgT Tg	PCR	Bulman and Marshall (1998)
<i>Sp. subterranea</i>	rDNA	Spo9	CAC gCC AAT ggT TAg AgA Cg	PCR	Bulman and Marshall (1998)
<i>Sp. nasturtii</i>	rDNA	SSN18	ATT ATC TCC gga TAG TTC TTg gA	PCR	Down and Clarkson (2002)
<i>Sp. nasturtii</i>	rDNA	SPO2	Agg CAg ACA gAT TAg ACT CT	PCR	Down and Clarkson (2002)
<i>Sp. nasturtii</i>	rDNA	WC1	gCA gAC AgA TTT gAC TCT gg	PCR	Bulman et al. (2001)
<i>So. veronicae</i>	rDNA	SV1	gCC gAC AAT CAC ATT CAA CC	PCR	Bulman et al. (2001)
<i>So. viticola</i> (Plasmodiophorids?)	rDNA	Psvit F	ACg CgT TCC AAC TTC TTA gAg gGA	PCR	This article
<i>So. viticola</i> (Plasmodiophorids?)	rDNA	Psvit R	CAT gCC TCT CTg AgT ATC ggT TTC	PCR	This article



**Fig. 3.10** Diagrammatic illustration of species specific PCR primers and their position on the 18S – ITS1 – 5.8S – ITS2 – 28S ribosomal rDNA region. Primer sequences and the corresponding references can be found in Table 3.3

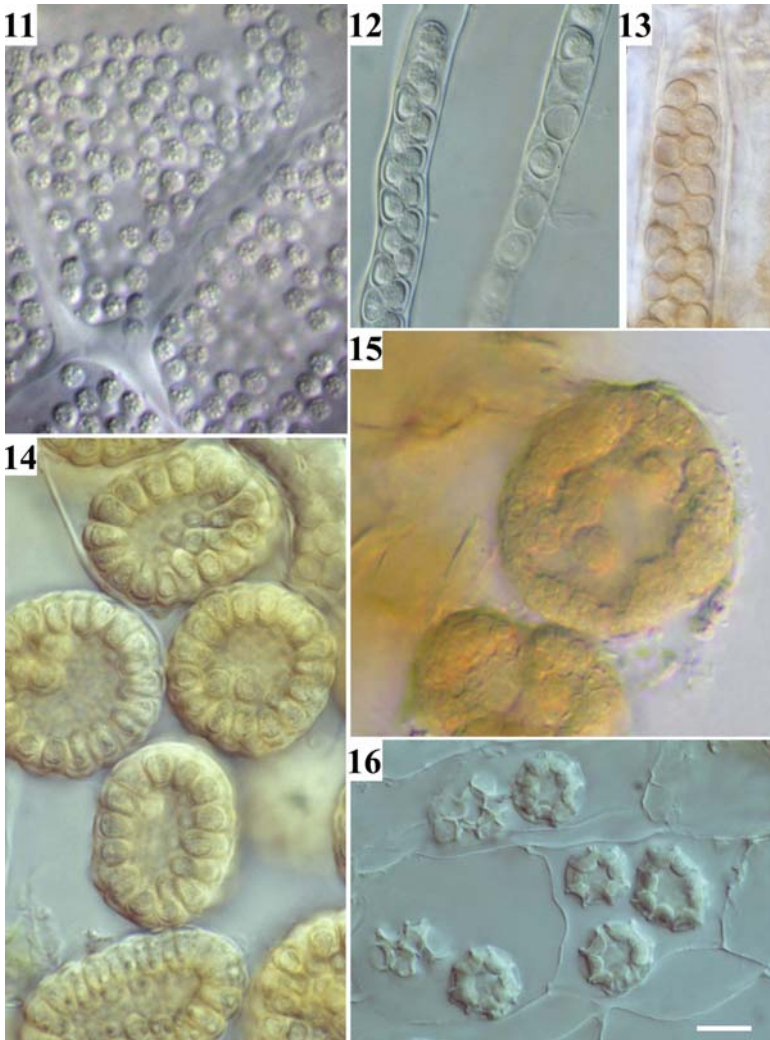
this gene was used in a multiplex reverse-transcriptase PCR (mRT-PCR) for the simultaneous detection of *Px. betae* and the viruses it transmits (BNYVV, BSBV, and BVQ, Meunier et al. 2003). An advantage of using RNA as template for PCR is that only active cells are detected and consequently positive results will only be obtained when the pathogen is active in the host plant. But, when resting spores need to be detected, this method has the serious drawback that resting spores contain little RNA. For growers and breeders, it is important to detect soil-inoculum

prior to planting, so DNA-based methods may be preferred. One disadvantage of nucleic acid-based methods is that processing of samples usually has to be done in the lab with specialised equipment and specially trained staff. For other plant pathogens, on-site PCR methods have been described recently (Tomlinson et al. 2005). Results can be obtained within a few hours in the field, but on-site detection is more difficult. For example, there is the need for electric power supply and a high risk of cross-contamination. Specialist staffs are also required. Therefore, the on-site PCR detection methods are to date not technically mature enough to provide robust high-throughput screenings in the field.

The intimate contact of plasmodiophorids with their host plants or with soil matrix is the reason for another problem: the sensitivity for all PCR methods was high for purified zoospore or resting spore preparations, but decreased when plasmodiophorids needed to be detected in plant material or soil samples (Faggian et al. 1999). These problems are not restricted to plasmodiophorids: the biggest difficulty in the application of PCR-based methods in phytopathology is to reproducibly extract high quality DNA from plants and soil (Mumford et al. 2006). The presence of various impurities, co-extracted with soil – such as humic acids, polysaccharides, or metal ions – can hamper PCR (Wilson 1997; Robe et al. 2003). Inhibitory compounds from plant tissues (e.g. polyphenolic substances like tannins or polysaccharides) interfere in the DNA extraction process as well as in later processing steps like PCR. These compounds vary between soil types, within plants, between plant species, and with different (soil) management systems. Hence, it is not surprising that many methods have been published for DNA extraction from soil samples (for reviews see Lakay et al. 2007; Robe et al. 2003; Wilson 1997). Microorganisms are unevenly distributed in soil: they can be bound to soil particles or aggregated around organic matter. Therefore, strong sampling strategies are required to detect soilborne pathogens. However, the production of high quality DNA extracts from plants or soil remains the critical step in nucleic-acid-based detection systems for plasmodiophorids.

### 3.3 Plasmodiophorid Genomics

A more complete understanding of the different phases of plasmodiophorid life cycles is of great interest. Much effort has been made to develop DNA-based methods for the detection of plant pathogenic plasmodiophorids, but basic questions about how and which biochemical processes the plasmodiophorid manipulates in the host plant remains unresolved. Even in the “molecular era”, species and genus concepts within the plasmodiophorids are mainly based on the morphology of the sporosori (Figs. 3.11–3.16) and on the host plants (Braselton 2001). Of the different stages of plasmodiophorids, only the resting spores can be used to identify and diagnose a plasmodiophorid in the host plant. Observation of zoosporangia, or even more so, plasmodia and zoospores, is time consuming, demanding, and does not allow discrimination at the species level. Molecular tools are needed to



**Figs. 3.11–3.16** Resting spores of different plasmodiophorids: **Fig. 3.11:** *Plasmidiophora brassicae* in roots of *Brassica oleracea* (cauliflower). **Fig. 3.12:** *Ligniera junci* in roothairs of *Juncus triglumis*. **Fig. 3.13:** *Polymyxa graminis* in roots of Poaceae. **Fig. 3.14:** *Sorosphaera veronicae* in shoot of *Veronica persica*. **Fig. 3.15:** *Spongospora subterranean* on tubers of *Solanum tuberosum* (potato). **Fig. 3.16:** *Sorosphaera viticola* in roots of *Vitis berlandieri* × *riparia* SO4 (bar = 10 μm)

determine the species or resolve the processes at the plant-parasite interface. Until the first plant genomes were fully sequenced and annotated, few workers met the challenge of studying the molecular basis of plasmodiophorid infection (Buhariwalla and Mithen 1995; Mutasa et al. 1995; Subr et al. 2002; Brodmann et al. 2002; Graf et al. 2004). The fully sequenced and annotated genome of



*Arabidopsis thaliana*, which serves as a host plant for *Pl. brassicae*, opened new possibilities to study plant/host interactions. In recent years the *Arabidopsis/Plasmodiophora* pathosystem has been increasingly used to understand processes induced by the pathogen and the subsequent physiological changes in the plant (Winkel-Shirley 2002). A search in the ISI Web of Knowledge database (*isiknowledge.com*) using the term “*Plasmodiophora* AND *Arabidopsis*” produces 60 hits (Accession date: 09.10.2008, 20:35 CET). Only 13 of these works were undertaken between 1992, when the first work was published, and 2000 when the *Arabidopsis* genome was launched (The Arabidopsis Genome Initiative 2000). Since 2001, 47 works have been published, with 29 of these published from 2006 onwards. Therefore, progress in the genome sequencing of other susceptible plants should help us to understand the mode of interaction of host plants and plasmodiophorids to shed light on their biotic interactions.

Transcriptome analysis of *Arabidopsis* plants suffering from clubroot disease has revealed that more than 1,000 genes are differentially expressed in infected roots (Siemens et al. 2006). The use of *Arabidopsis* microarrays has demonstrated that genes involved in cell division and expansion, as well as genes associated with plant growth hormones like auxin and cytokinin, are upregulated (Siemens et al. 2006). Interestingly, genes involved in pathogen defence showed either no response to an infection or were downregulated shortly after the infection. This indicates an even closer interplay between plasmodiophorid parasites and their host plant than suspected. The susceptible biotic interaction and the partial resistance of some *Arabidopsis* varieties to clubroot infection have stimulated the study of differences in resistant and susceptible plants at the molecular level (Jubault et al. 2008) as well.

Cao et al. (2008) investigated proteome-level changes in the roots of clubbed roots of *Brassica napus*. They found 20 proteins to be differentially produced when canola plants were challenged by *Pl. brassicae*. Results indicate that lignin biosynthesis in the host plant decreased, as did enzymes that are involved in the reactive oxygen species metabolism. This again points toward a very close interplay between plasmodiophorids and their hosts. As found in *A. thaliana*, proteins involved in plant growth hormone pathways were increasingly produced.

*Arabidopsis* and *Pl. brassicae* have not only been used to study the changes in the host plant after infection but have also been used to identify genes from the plasmodiophorid (Bulman et al. 2006; Bulman et al. 2007). The obligate nature of the parasite means that a mixture of pathogen and plant is obtained from metabolically active plasmodia. To lessen the number of plant genes, suppression subtractive hybridization between the pathogen and plant RNA was used. The annotated genome of the host plant also allowed the exclusion of host-sequences from the analysis. Seventy six new plasmodiophorid genes were identified (Bulman et al. 2006). In a subsequent work, an intron-rich structure of *Pl. brassicae* genes was described (Bulman et al. 2007).

Almost everything we know about plasmodiophorid–plant interactions is compiled from experiments with *Pl. brassicae*, whereas we know very little about the interactions of plasmodiophorids that do not form galls (e.g. *Px. graminis*).



Even less is known about species without economic impact. It will be an interesting task for future research to investigate how these plasmodiophorids influence host metabolism and communicate with the plant.

### 3.4 How Common are Plasmodiophorids?

It is unclear whether plasmodiophorids are genuinely rare, or if their abundance is currently underestimated. As an illustration of this, almost nothing is known about plasmodiophorids infecting plants without agricultural value. This lack of information is reflected in the molecular data available: At NCBI Genbank, there are sequences of only 11 phytomyxid species (3 phagomyxids, 8 plasmodiophorids), amounting to a total of 152 nucleotide sequences (Search term “txid37358”, accession date: 26.9.2008, 19:23 CET). Furthermore, only seven of the sequences from plasmodiophorids infecting green plants are from economically “unimportant” species [*So. veronicae* (4), *Ligniera* sp. (2), and *So. viticola* (1)]. These nucleotide sequences were all derived from one isolate each. Genomic survey sequences (GSS) were deposited only for *Pl. brassicae* (9) and expressed sequence tags (ESTs) have been deposited only for *Pl. brassicae* (93) and *Px. graminis* (1). Sixty protein sequences have been obtained from five species, with the vast majority again from *Pl. brassicae* (49). Only five sequences derived from environmental clone-libraries are assigned as “plasmodiophorid” although our unpublished sequence comparisons show that there are some unrecognised plasmodiophorids assigned as “uncultured fungus” or “uncultured eukaryote”. Given the progress of environmental screenings using clone-libraries (López-García and Moreira 2008), this number is low.

The idea that the abundance of plasmodiophorids may be underestimated is encouraged by the results of our sampling of *Juncus* sp. from five different locations in Austria during summer and autumn 2008. When the root hairs were screened by microscopy, *Ligniera junci* could be observed easily in four samples. In one *Juncus* sample, an unintentionally co-sampled *Poaceae* was found to be infested with *Px. graminis*. At the same location, *So. veronicae* was previously found in shoots of *Veronica persica* (Neuhauser et al. 2005). Another *Ligniera*-positive *Juncus* sp. was collected in an area where fungal soil-clone libraries were constructed during a 3 year survey on alterations of soil fungal communities. No plasmodiophorid sequences were detected in that study (Oberkofler 2008) although the primers used have been employed to obtain sequences from plasmodiophorids (Ward et al. 1994). In these examples, the random sampling of potential host plants indicated a high abundance and diversity of plasmodiophorids. It will be highly desirable to develop new PCR primers which preferentially amplify phytomyxids to learn more about these biotrophic parasites. In a preliminary experiment of this kind, we have designed primers for the amplification of partial SSU, ITS 1, and 5.8S rDNA from *So. viticola* (Table 3.3). These primers were successfully used for direct sequencing of different isolates of *L. junci*, *Px. graminis*, and *So. veronicae*

from plant material. Those primers have not yet been fully tested, but they seem to be suitable to directly sequence plasmodiophorids from different hosts and give good PCR results when used with soil DNA extracts. PCR primers specific for plasmodiophorids as well as the phagomyxids would allow an active inclusion in analyses of different habitats, which would be a valuable step towards a better understanding of this enigmatic group of eukaryotes. As noted earlier, there are a small but increasing number of unassigned plasmodiophorid sequences appearing in DNA-databases. A coordinated study of these sequences together with specific environmental screening has the potential to reveal new diversity among plasmodiophorids.

### 3.5 Conclusions and Future Research

Although, much recent progress has been made in understanding plasmodiophorids and their interactions with their host plants, they remain a cryptic group of organisms. Few species have been studied in detail, and what is known about these raises more questions than answers. The ecological importance of the plasmodiophorids cannot be evaluated, because their distribution and abundance in non-agricultural areas are not known. Classical screenings are time-consuming and laborious as most plasmodiophorids have a biotrophic interaction with their host plants. It will be important to gain data about the abundance of plasmodiophorids in terrestrial, fresh water, and marine ecosystems. Plasmodiophorids have a large impact on their hosts and may have an important role in shaping certain ecosystems. With the progress of DNA-based taxonomy and detection methods, it will be important to define suitable regions for barcoding in plasmodiophorids. To date mostly rDNA sequence data are available and the 18S region seems to be a promising target. Because of their obligate affiliation with their host plants and to decrease the risk of negative-primer bias, it would be of great use to identify a unique region in the plasmodiophorid genome to minimize the risk of cross-reactions with host plants and other endophytic organisms. First studies on *Pl. brassicae* genes indicate that there are genes which have no similarity with genes from any other organism (Bulman et al. 2006; Bulman et al. 2007). To define if one of these regions is suitable for barcoding of phytomyxids will be task of future research. DNA data from several regions of the plasmodiophorid genomes would also be desirable to create a multigene phylogenetic tree. This would facilitate a better understanding of the intra- and infragenetic relationships between plasmodiophorid species and related organisms and help the plasmodiophorids to occupy a well defined place in the tree of life. As the life cycle of many plasmodiophorids is not resolved in detail, molecular data should be supplemented with morphological data. This would allow a new, more comprehensive classification and characterization of the plasmodiophorids.

Random samplings indicate that in certain habitats plasmodiophorids occur in high abundance. To evaluate their possible regulatory or selective role in these

ecosystems, data on their distribution and their interaction with primary and alternative host plants are needed. It is not known if there is a difference in the interaction with the host plant when primary or secondary plasmodia are formed. The primary sporogenic plasmodia can be formed in different intermediate host plants (Karling 1968; Legrève et al. 2000; Legrève et al. 2005; Qu and Christ 2006b) and do not cause any visible symptoms in the host plant. More information about this life cycle stage and comparative analysis with the primary plasmodia could help to understand the compatible interactions leading to hypertrophic growth of the host plant. This information could provide a guide for the breeding of resistant plants.

There remains a great deal to be learnt about the biology of this fascinating and increasingly important group of organisms.

**Acknowledgements** The authors wish to thank Ueli Merz and Lars Huber for providing plasmodiophorid samples. We are indebted to Reinhold Pöder for passing on valuable comments and for his kind support with taking the micrographs. The work was partially supported by the FWF (Austrian Science Fund, grant T379-B16, SN).

## References

- Adams MJ, Antoniw JF (2006) DPVweb: a comprehensive database of plant and fungal virus genes and genomes. *Nucl Acids Res* 34:D382–D385
- Adl SM, Simpson AGB, Farmer MA, Andersen RA, Anderson OR, Barta JR, Bowser SS, Brugerolle GUY, Fensome RA, Fredericq S, James TY, Karpov S, Kugrens P, Krug J, Lane CE, Lewis LA, Lodge J, Lynn DH, Mann DG, McCourt RM, Mendoza L, Moestrup O, Mozley-Standridge SE, Nerad TA, Shearer CA, Smirnov AV, Spiegel FW, Taylor MFJR (2005) The new higher level classification of eukaryotes with emphasis on the taxonomy of protists. *J Eukaryot Microbiol* 52:399–451
- Aist JR, Williams PH (1971) The cytology and kinetics of cabbage root hair penetration by *Plasmodiophora brassicae*. *Can J Bot* 49:2023–2034
- Alexopoulos CJ, Mims CW (1979) *Introductory mycology*, 3rd edn. Wiley, New York
- Archibald JM, Keeling PJ (2004) Actin and ubiquitin protein sequences support a cercozoan/foraminiferan ancestry for the plasmodiophorid plant pathogens. *J Eukaryot Microbiol* 51:113–118
- Arie T, Namba S, Yamashita S, Doi Y (1988) Detection of resting spores of *Plasmodiophora brassicae* Woron. from soil and root by fluorescent-antibody technique. *Ann Phytopathol Soc Jap* 54:242–245
- Barr DJS (1992) Evolution and kingdoms of organisms from the perspective of a mycologist. *Mycologia* 84:1–11
- Bell KS, Roberts J, Verrall S, Cullen DW, Williams NA, Harrison JG, Toth IK, Cooke DEL, Duncan JM, Claxton JR (1999) Detection and quantification of *Spongospora subterranea* f. sp. *subterranea* in soils and on tubers using specific PCR primers. *Eur J Plant Pathol* 105:905–915
- Brakke MK (1971) Soil-borne wheat mosaic virus. Commonwealth Mycological Institute/Association of Applied Biologists Descriptions of Plant Viruses, no 77
- Braselton JB (1995) Current status of the plasmodiophorids. *Crit Rev Microbiol* 21:263–275
- Braselton JB (2001) Plasmodiophoramycozoa. In: Mc Laughlin DJ, Mc Laughlin EG, Lemke PA (eds) *The Mycota VII Part A*. Springer, Berlin, Heidelberg, pp 81–91

- Brodmann D, Schuller A, Ludwig-Muller J, Aeschbacher RA, Wiemken A, Boller T, Wingler A (2002) Induction of trehalase in *Arabidopsis* plants infected with the trehalose-producing pathogen *Plasmodiophora brassicae*. *Mol Plant Microbe* 15:693–700
- Bruns C, Gottschall R, Marchiniszyn E, Schüler C, Zeller W, Wolf G, Vogtmann H (1994) Phytohygiene der Kompostierung – Sachstand, Prüfmethode, F. und E. Vorhaben. In: Tagungsband BMFT-Statusseminar Neue Techniken der Kompostierung. Hamburg, pp 191–206
- Buczacki ST (1983) *Plasmodiophora*, an interrelationship between biological and practical problems. In: Buczacki ST (ed) Zoospore plant pathogens, a modern perspective. Academic Press, New York, pp 339–353
- Buhariwalla H, Greaves S, Magrath R, Mithen R (1995) Development of specific PCR primers for the amplification of polymorphic DNA from the obligate root pathogen *Plasmodiophora brassicae*. *Physiol Mol Plant Pathol* 47:83–94
- Bulman SR, Marshall JW (1998) Detection of *Spongospora subterranea* in potato tuber lesions using the polymerase chain reaction (PCR). *Plant Pathol* 47:759–766
- Buhariwalla H, Mithen R (1995) Cloning of a *Brassica* repetitive DNA element from resting spores of *Plasmodiophora brassicae*. *Physiol Mol Plant Pathol* 47:95–101
- Bulman SR, Kuhn SF, Marshall JW, Schnepf E (2001) A phylogenetic analysis of the SSU rRNA from members of the Plasmodiophorida and Phagomyxida. *Protist* 152:43–51
- Bulman S, Siemens J, Ridgway HJ, Eady C, Conner AJ (2006) Identification of genes from the obligate intracellular plant pathogen, *Plasmodiophora brassicae*. *FEMS Microbiol Lett* 264:198–204
- Bulman SR, Ridgway HJ, Eady C, Conner AJ (2007) Intron-rich gene structure in the intracellular plant parasite *Plasmodiophora brassicae*. *Protist* 158:423–433
- Cao T, Srivastava S, Rahman MH, Kav NNV, Hotte N, Deyholos MK, Strelkov SE (2008) Proteome-level changes in the roots of *Brassica napus* as a result of *Plasmodiophora brassicae* infection. *Plant Sci* 174:97–115
- Castlebury LA, Dormier LL (1998) Small subunit ribosomal RNA gene phylogeny of *Plasmodiophora brassicae*. *Mycologia* 90:102–107
- Cavalier-Smith T (1993) The protozoa phylum Opalozoa. *J Euk Microbiol* 40:609–615
- Cavalier-Smith T (1998) Neomonada and the Origin of Animals and Fungi. In: Coombs GH, Vickerman K, Sleigh MA, Warren A (eds) Evolutionary Relationships Among Protozoa. Kluwer, London, pp 375–407
- Cavalier-Smith T (2000) Flagellate Megaevolution: the Basis for Eukaryote Diversification. In: Green JR, Leadbeater BSC (eds) The Flagellates. Taylor and Francis, London, pp 361–390
- Cavalier-Smith T, Chao EE-Y (1996/1997) Sarcomonad ribosomal RNA sequences, rhizopod phylogeny, and the origin of euglyphid amoebae. *Arch Protistenkd* 147: 227–236
- Cavalier-Smith T, Chao EE-Y (2003) Phylogeny and Classification of Phylum Cercozoa (Protozoa). *Protist* 154:341–358
- Christensen KK, Kron E, Carlsbaek M (2001) Development of a Nordic System for Evaluating the Sanitary Quality of Compost. Nordic Council of Ministers, Copenhagen
- Ciafardini G, Marotta B (1989) Use of the Most-Probable-Number technique to detect *Polymyxa betae* (Plasmodiophoromycetes) in soil. *Appl Environ Microbiol* 55:1273–1278
- Cook WRI (1932) The Parasitic slime moulds. *Hong Kong Nat Suppl* 1:29–39
- Delfosse P, Barghava AK, Sobti AK, Reddy AS, Abdurahman MD, Legrève A, Maraite H, Reddy DVR (1999) Geographic distribution of the Indian peanut clump virus (IPCV) in Rajasthan: Soil characteristics and farming practices influencing the disease occurrence. In: Proceedings of the 4<sup>th</sup> symposium of the international working group on plant viruses with fungal vectors. American Society of sugar beet Technologists, Denver, USA, pp. 109–112
- Delfosse P, Reddy AS, Legerve A, Devi KT, Abdurahman MD, Maraite H, Reddy DVR (2000) Serological methods for detection of *Polymyxa graminis*, an obligate root parasite and vector of plant viruses. *Phytopathology* 90:537–545

- Down GJ, Clarkson JM (2002) Development of a PCR-based diagnostic test for *Spongospora subterranea* f.sp. *nasturtii*, the causal agent of crook root of watercress (*Rorippa nasturtium-aquaticum*). *Plant Pathol* 51:275–280
- EPPO (1997) Data Sheets on Quarantine Pests. Beet necrotic yellow vein furovirus. In: Smith IM, McNamara DG, Scott PR, Holderness M (eds) *Quarantine Pests for Europe*, 2nd edn. CABI International, Wallingford
- Faggian R, Lawrie AC, Bulman SR, Porter IJ (1999) Specific polymerase chain reaction primers for the detection of *Plasmodiophora brassicae* in soil and water. *Phytopathology* 89:392–397
- Graf H, Fahling M, Siemens J (2004) Chromosome polymorphism of the obligate biotrophic parasite *Plasmodiophora brassicae*. *J Phytopathol* 152:86–91
- Harrison JG, Rees EA, Barker H, Lowe R (1993) Detection of spore balls of *Spongospora subterranea* on potato tubers by enzyme-linked-immunosorbent-assay. *Plant Pathol* 42: 181–186
- Huber L, Scholz C, Eisenbeis G, Rühl EH, Neuhauser S, Kirchmair M (2006) Field distribution of *Sorosphaera viticola* in commercial vineyards in Germany. *FEMS Microbiol Lett* 260:63–68
- Ingram DS, Tommerup IC (1972) The life history of *Plasmodiophora brassicae* Woron. *Proc R Soc Lond B* 180:103–112
- Ito S, Maehara T, Tanaka S, Kameya Iwaki M, Yano S, Kishi F (1997) Cloning of a single-copy DNA sequence unique to *Plasmodiophora brassicae*. *Physiol Mol Plant Pathol* 50:289–300
- Ito S, Maehara T, Maruno E, Tanaka S, Kameya-Iwaki M, Kishi F (1999) Development of a PCR-based assay for the detection of *Plasmodiophora brassicae* in soil. *J Phytopathol* 147:83–88
- Jørstad I (1923) Hvorledes skal man bekaempe klumproten paa vore Kaalvekster? *Norsk Havetid* 39:126–127
- Jubault M, Lariagon C, Simon M, Delourme R, Manzanares-Dauleux MJ (2008) Identification of quantitative trait loci controlling partial clubroot resistance in new mapping populations of *Arabidopsis thaliana*. *Theor Appl Genet* 117:191–202
- Kanyuka K, Ward E, Adams MJ (2003) *Polymyxa graminis* and the cereal viruses it transmits: a research challenge. *Mol Plant Pathol* 4:393–406
- Karling JS (1968) *The Plasmodiophorales*, 2nd completely revised Edition. Hafner Publishing Company, New York, p 256
- Keeling PJ (2001) Foraminifera and Cercozoa are related in actin phylogeny: Two orphans find a home? *Mol Biol Evol* 18:1551–1557
- Keeling P, Leander BS, Simpson A (2008) Eukaryotes. Eukaryota, Organisms with nucleated cells. In: *The Tree of Life Web Project*, <http://tolweb.org/> Version 02 September 2008 (under construction). <http://tolweb.org/Eukaryotes/3/2008.09.02>
- Keskin B, Fuchs WH (1969) Der Infektionsvorgang bei *Polymyxa betae*. *Arch Mikrobiol* 68:218–226
- Kingsnorth CS, Asher MJC, Chwarszczynska DM, Luterbacher MC, Mutasa-Göttgens ES, Keane GJP (2003a) Development of a recombinant antibody ELISA test for the detection of *Polymyxa betae* and its use in resistance screening. *Plant Pathol* 52:673–680
- Kingsnorth CS, Chwarszczynska DM, Asher MJC, Kingsnorth AJ, Lyons PA (2003b) Real-time analysis of *Polymyxa betae* GST expression in infected sugar beet. *Mol Plant Pathol* 4:171–176
- Knoll K-H, Strauch D, Holst H (1980) Standardisierung von Hygieneuntersuchungen für Kompostierungsverfahren. *Forschungsbericht* 79-10302403, Umweltforschungsplan des MBI, Abfallwirtschaft
- Kucharek TA, Walker JH (1974) The presence of and damage caused by soilborne wheat mosaic virus in Florida. *Plant Dis Rep* 58:763–765
- Lakay FM, Botha A, Prior BA (2007) Comparative analysis of environmental DNA extraction and purification methods from different humic acid-rich soils. *J Appl Microbiol* 102:265–273
- Legrève A, Vanpee B, Delfosse P, Maraite H (2000) Host range of tropical and sub-tropical isolates of *Polymyxa graminis*. *Eur. J Plant Pathol* 106:379–389

- Legrève A, Delfosse P, Maraite H (2002) Phylogenetic analysis of *Polymyxa* species based on nuclear 5.8 S and internal transcribed spacers ribosomal DNA sequences. *Mycol Res* 106:138–147
- Legrève A, Delfosse P, Van Hese V, Bragard C, Maraite H (2003) Broad-spectrum detection of *Polymyxa* species and form species by polymerase chain reaction. In: Rush C, Merz U (ed) Proceedings of the fifth Symposium of the International Working Group on Plant Viruses with Fungal Vectors. American Society of Sugar Beet Technologists, Denver Zurich, pp 40–43
- Legrève A, Schmit J, Bragard C, Maraite H (2005) The role of climate and alternative hosts in the epidemiology of rhizomania. In: Rush C (ed) Proceedings of the sixth symposium of the international working group on plant viruses with fungal vectors. American Society of Sugar Beet Technologists, Denver Zurich, pp 125–129
- López-García P, Moreira D (2008) Tracking microbial biodiversity through molecular and genomic ecology. *Res Microbiol* 159:67–73
- Ludwig-Müller J, Schuller A (2008) What can we learn from clubroots: alterations in host roots and hormone homeostasis caused by *Plasmodiophora brassicae*. *Eur J Plant Pathol* 121:291–302
- Merz U, Walsh JA, Bouček-Mechiche K, Oberhänsli T, Bitterlin W (2005) Improved immunological detection of *Spongospora subterranea*. *Eur J Plant Pathol* 111:371–379
- Merz U (2008) Powdery scab of potato – Occurrence, life cycle and epidemiology. *Am J Potato Res* 4:241–246
- Meunier A, Schmit J-F, Stas A, Bragard C, Kutluk N (2003) Multiplex reverse transcription-PCR for simultaneous detection of *Beet necrotic yellow vein virus*, *Beet soilborne virus*, and *Beet virus Q* and their vector *Polymyxa betae* Keskin on sugar beet. *Appl Environ Microbiol* 69:2356–2360
- Mithen R, Magrath R (1992) A contribution to the life history of *Plasmodiophora brassicae*: secondary plasmodia develop in root galls of *Arabidopsis thaliana*. *Mycol Res* 96:877–885
- Mumford R, Boonham N, Tomlinson J, Barker I (2006) Advances in molecular phyto diagnostics – New solutions for old problems. *Eur J Plant Pathol* 116:1–19
- Mutasa ES, Chwarszczynska DM, Adams MJ, Ward E, Asher MJC (1995) Development of PCR for the detection of *Polymyxa betae* in sugar beet roots and its application in field studies. *Physiol Mol Plant Pathol* 47:303–313
- Mutasa ES, Chwarszczynska DM, Asher MJC (1996) Single-tube nested PCR for the diagnosis of *Polymyxa betae* infection in sugar beet roots and colorimetric analysis of amplified products. *Phytopathology* 86:493–497
- Mutasa-Göttgens ES, Chwarszczynska DM, Halsey K, Asher MJC (2000) Specific polyclonal antibodies for the obligate plant parasite *Polymyxa* – a targeted recombinant DNA approach. *Plant Pathol* 49:276–287
- Naiki T, Kawaguchi C, Ikegami H (1984) Root hair reinfection in Chinese cabbage seedlings by secondary zoospores of *Plasmodiophora brassicae* Woronin. *Ann Phytopathol Soc Japan* 50:216–220
- Narisawa K, Kageyama K, Hashiba T (1996) Efficient root infection with single resting spores of *Plasmodiophora brassicae*. *Mycol Res* 100:855–858
- Narisawa K, Hashiba T (1998) Development of resting spores on plants inoculated with a dikaryotic resting spore of *Plasmodiophora brassicae*. *Mycol Res* 102:949–952
- Neuhauser S, Huber L, Kirchmair M (2005) *Sorosphaera veronicae*; neu für Österreich. *Österreichische Zeitschrift für Pilzkunde* 14:303–308
- Nielsen NJ (1933) Forsøg med Bekaempelse af Kaalbroksvamp. *Tidsskr Planteavl* 39:361–391
- Nikolaev SI, Berney C, Fahrni JF, Bolivar I, Polet S, Mylnikov AP, Aleshin VV, Petrov NB, Pawlowski J (2004) The twilight of Heliozoa and rise of Rhizaria, an emerging supergroup of amoeboid eukaryotes. *Proc Natl Acad Sci USA* 101:8066–8071
- Noble R, Roberts SR (2004) Eradication of plant pathogens and nematodes during composting: a review. *Plant Pathology* 53:548–568
- Oberkofler I (2008) Soil fungal communities in an alpine primary successional habitat. PhD thesis, Leopold Franzens University Innsbruck

- Qu XS, Christ BJ (2006a) Single cystosorus isolate production and restriction fragment length polymorphism characterization of the obligate biotroph *Spongospora subterranea* f. sp. *subterranea*. *Phytopathology* 96:1157–1163
- Qu XS, Christ BJ (2006b) The host range of *Spongospora subterranea* f. sp. *subterranea* in the United States. *Am J Potato Res* 83:343–347
- Ratna AS, Rao AS, Reddy AS, Nolt BL, Reddy DVR, Vijayalakshmi M, McDonald D (1991) Studies on transmission of Indian peanut clump virus disease by *Polymyxa graminis*. *Ann Appl Biol* 118:71–78
- Robe P, Nalin R, Capellano C, Vogel TM, Simonet P (2003) Extraction of DNA from soil. *Eur J Soil Biol* 39:183–190
- Siemens J, Keller I, Sarx J, Kunz S, Schuller A, Nagel W, Schmulling T, Parniske M, Ludwig-Muller J (2006) Transcriptome analysis of *Arabidopsis* clubroots indicate a key role for cytokinins in disease development. *Mol Plant Microbe* 19:480–494
- Subr ZW, Kastirr U, Kühne T (2002) Subtractive cloning of DNA from *Polymyxa graminis* – An obligate parasitic plasmodiophorid. *J Phytopathol* 150:564–568
- The Arabidopsis Genome Initiative (2000) Analysis of the genome sequence of the flowering plant *Arabidopsis thaliana*. *Nature* 408:796–815
- Timila RD, Correll JC, Duwadi VR (2008) Severe and widespread clubroot epidemics in Nepal. *Plant Dis* 96:317
- Tomlinson JA, Boonham N, Hughes KJD, Griffen RL, Barker I (2005) On-site DNA extraction and real-time PCR for detection of *Phytophthora ramorum* in the field. *Appl Environ Microbiol* 71:6702–6710
- Tommerup IC, Ingram DS (1971) The life-cycle of *Plasmodiophora brassicae* Woron. in *Brassica* tissue cultures and in intact roots. *New Phytol* 70:327–332
- Vaïanopoulos C, Bragard C, Maraite H, Legrève A (2005) Methods for detection of *Polymyxa graminis* f. sp. *temperata* and *Polymyxa graminis* f. sp. *tepidata* in association with bymo- and furoviruses. Proceedings of the 6th Symposium of the International Working Group on Plant Viruses with Fungal Vectors (IWGPVVFV), Bologna, Italy, p 18
- van de Graaf P, Lees AK, Cullen DW, Duncan JM (2003) Detection and quantification of *Spongospora subterranea* in soil, water and plant tissue samples using real-time PCR. *Eur J Plant Pathol* 109:589–597
- Varellmann M (2007) Occurrence, spread and pathogenicity of different forms of the Rhizomania virus (*Beet necrotic yellow vein virus*, BNYVV) – Review on biology and variability of Rhizomania and on detection of isolates possibly overcoming resistance. *Zuckerindustrie* 132:113–120
- Wakeham AJ, White JG (1996) Serological detection in soil of *Plasmodiophora brassicae* resting spores. *Physiol Mol Plant Pathol* 48:289–303
- Wallace A, Williams NA, Lowe R, Harrison JG (1995) Detection of *Spongospora-subterranea* using monoclonal-antibodies in ELISA. *Plant Pathol* 44:355–365
- Wallenhammar A-C, Arwidsson O (2001) Detection of *Plasmodiophora brassicae* by PCR in naturally infested soils. *Eur J Plant Pathol* 107:313–321
- Walsh JA, Merz U, Harrison JG (1996) Serological detection of spore balls of *Spongospora subterranea* and quantification in soil. *Plant Pathol* 45:884–895
- Ward E, Adams MJ, Mutasa CR, Collier CR, Asher MJC (1994) Characterisation of *Polymyxa* species by restriction analysis of PCR-amplified ribosomal DNA. *Plant Pathol* 43:872–877
- Ward E, Adams M (1998) Analysis of ribosomal DNA sequences of *Polymyxa* species and related fungi and the development of genus- and species-specific primers. *Mycol Res* 102:965–974
- Ward E, Foster SJ, Fraaije BA, McCartney AH (2004a) Plant pathogen diagnostics: immunological and nucleic acid-based approaches. *Ann Appl Biol* 145:1–16
- Ward E, Kanyuka K, Motteram J, Korniyukhin D, Adams MJ (2005a) The use of conventional and quantitative real-time PCR assays for *Polymyxa graminis* to examine host plant resistance, inoculum levels and intraspecific variation. *New Phytol* 165:875–885
- Ward E, Motterham J, Kanyuka K, Adams MJ (2005b) The use of PCR methods for *Polymyxa graminis* to study intraspecific variation, phylogeny and inoculum levels. In: Rush, C (ed)

- Proceedings of the 6<sup>th</sup> symposium of the international working group on plant viruses with fungal vectors. American Society of sugar beet Technologists, Denver, pp 100–103
- Ward LI, Fenn MGE, Henry CM (2004b) A rapid method for direct detection of *Polymyxa* DNA in soil. *Plant Pathol* 53:485–490
- Wilson IG (1997) Inhibition and facilitation of nucleic acid amplification. *Appl Environ Microbiol* 63:3741–3751
- Winkel-Shirley B (2002) Biosynthesis of flavonoids and effects of stress. *Curr Opin Plant Biol* 5:218–223
- Woronin M (1877) *Trudy St Petersburgskogo Obshchestva Estestvoispytatelei* 8:169
- Woronin M (1878) *Plasmodiophora brassicae*. Urheber der Kohlpflanzen Hernie. *Jahrbuch für wissenschaftliche Botanik* 11:548–574



# Chapter 4

## Applications of Molecular Markers and DNA Sequences in Identifying Fungal Pathogens of Cool Season Grain Legumes

Evans N. Njambere, Renuka N. Attanayake, and Weidong Chen

**Abstract** Molecular techniques have now been widely applied in many disciplines of biological sciences including fungal identification in microbial ecology and in plant pathology. In plant pathology, it is now common to use molecular techniques to identify and study plant pathogens of many agronomical and horticultural crops including cool season grain legume crops. In this chapter, we present two examples in which molecular techniques have been applied in order to identify and investigate multiple fungal pathogens causing two important diseases of chickpea and lentil. In each case, molecular techniques improved over traditional morphological identification and allowed timely and unambiguous identification of fungal pathogens. The first example involves identification of two *Sclerotinia* species (*S. sclerotiorum* and *S. trifoliorum*) causing stem rot of chickpea. Traditional method requires induction of carpogenic germination and observation of dimorphic ascospores in *S. trifoliorum*, which takes up to eight weeks. Taking advantage of the group I introns present in the nuclear small subunit rDNA of *S. trifoliorum* but absent in the same DNA region of *S. sclerotiorum*, a simple PCR amplification of the targeted DNA region allowed timely and reliable differentiation and identification of the species. The second example is of powdery mildew of lentil. Identification of powdery mildew fungi requires observing the teleomorphic (sexual) state of the pathogens, but this is not always available. In studying lentil powdery mildew in the US Pacific Northwest, we found that the powdery mildew on lentil does not fit previously reported species (*Erysiphe pisi* and *E. diffusa*). Further investigation confirmed that the lentil powdery mildew in the US is *E. trifolii*, a new pathogen of lentil. This discovery was mainly based on the rDNA ITS sequences and further confirmed by morphological and pathogenicity

---

E.N. Njambere and R.N. Attanayake

Department of Plant Pathology, Washington State University, Pullman, WA 99164, USA

W. Chen

Department of Plant Pathology, Washington State University, Pullman, WA 99164, USA

USDA ARS Grain Legume Genetics and Physiology Research Unit, Washington State University, Pullman, WA 99164, USA

e-mail: w-chen@wsu.edu

studies. These two examples demonstrate the important role of modern molecular techniques in solving practical agricultural problems. The ITS and adjacent rDNA could be ideal target regions for developing DNA barcodes for identifying these and related fungal species.

## 4.1 Introduction

Cool season grain legumes (chickpea, *Cicer arietinum*; faba bean, *Vicia faba*; lentil, *Lens culinaris*, and pea, *Pisum sativum*) are important crops worldwide. They are staple food crops in West Asian and North African countries and are important rotational and specialty crops in developed nations. Fungal diseases are important constraints in grain legume productions. Accurate identification of the fungal pathogens is in many cases a prerequisite for effective management of the diseases they cause and for ecological and population genetics studies. However, many fungal species are similar morphologically, and accurate species identification can be difficult. With current advances in biotechnology, molecular genetic markers have been employed for rapid identification of different kinds of fungi (White et al. 1990; Lieckfeldt and Seifert 2000; Njambere et al. 2008; Attanayake et al. 2009). The development of gene-specific primers for PCR amplification (White et al. 1990) has facilitated systematic studies, and the detection and identification of fungal pathogens. The internal transcribed spacer (ITS) region of nuclear ribosomal DNA has generally been considered a convenient marker for molecular identification of fungi at species level because of its conserved feature within species and multi-copy number per genome (Sanchez-Ballesteros et al. 2000). Henry et al. (2000) identified the fungus *Aspergillus* at species level and differentiated it from other true pathogenic and opportunistic molds using ITS 1 and ITS 2, allowing for early diagnosis and screening of effective antifungal agents for patients. Schneider et al. (1997) developed a method for detection of *Rhizoctonia solani* isolates, pathogenic and nonpathogenic to tulips, using ITS rDNA sequences, and they could further identify various anastomosis groups. Recent advancement in identifying fungal species using DNA markers is to develop DNA barcodes using species-specific oligonucleotides that are diagnostic of targeted species (Druzhinina et al. 2005). Such specific DNA regions need to be explored for different groups of fungi. In this chapter, we present two examples of applying molecular techniques in identifying fungal pathogens of cool season grain legumes.

## 4.2 Sclerotinia Stem Rot of Chickpea

Sclerotinia stem rot (Fig. 4.1a) is an important disease of chickpea under conducive environmental conditions and is caused by three species of *Sclerotinia*: *S. sclerotiorum*, *S. minor*, and *S. trifoliorum* (Bretag and Mebalds 1987). *Sclerotinia minor*



**Fig. 4.1** Symptoms and signs of *Sclerotinia* stem rot of chickpea caused by *Sclerotinia trifoliorum* (a), and powdery mildew of lentil caused by *Erysiphe trifolii* (b)

can be easily differentiated from the other two species based on its numerous, scattered small-sized sclerotia in culture and in the field. Morphological difference between *S. sclerotiorum* and *S. trifoliorum* is subtle. The ultimate differentiation between *S. sclerotiorum* and *S. trifoliorum* requires observation of ascospore morphology which entails carpogenic germination of sclerotia. Ascospores of *S. trifoliorum* show spore-size dimorphism (two different-sized ascospores within a single ascus), whereas ascospores of *S. sclerotiorum* show no dimorphism (Kohn 1979; Uhm and Fujii 1983a, b). Induction of carpogenic germination of sclerotia of *Sclerotinia* spp. is a time-consuming process, and may take up to several months. To further complicate the matter, some isolates of *S. trifoliorum* are heterothallic and require mating with a compatible strain for carpogenic germination and ascospore production (Uhm and Fujii 1983a, b). Even though the process of identifying members of the genus *Sclerotinia* through sclerotia and other morphological characteristics has been refined over time (Kohn 1979; Rehnstrom and Free 1993), there are limitations to this approach. For instance, the differentiation of *S. trifoliorum* from *S. sclerotiorum* based on sclerotial characteristics is difficult because of instability of some sclerotia characteristics with subsequent sub-culturing (Cother 1977).

Therefore, to facilitate the separation of the two species, research efforts have been made in searching for molecular techniques that are reliable and convenient to use. Power et al. (2001) reported that *S. trifoliorum* contains group I introns in the nuclear small subunit rDNA, whereas *S. sclerotiorum* and *S. minor* do not contain any introns in the same DNA region. Molecular analysis of the ITS region can eliminate many of the problems associated with the morphological characters and culturing. Analysis of ITS sequence is usually applied to determine species identity (or sometimes higher taxonomic categories) and to identify and discriminate populations within a species. In the genus *Sclerotinia*, the ITS region is generally not sufficiently variable to distinguish within species diversity; however, the nuclear small subunit rDNA (nSSRrDNA) has been used for this type of study (Holst-Jensen et al. 1999; Power et al. 2001). In this study we explored the differences in the ITS and the nuclear small subunit regions of the rDNA between the two species causing *Sclerotinia* stem rot of chickpea.

### 4.2.1 DNA Isolation and ITS Sequence Analysis

DNA was isolated from mycelial mats or sclerotia using the standard extraction procedures such as the FastDNA® kit described by Chen et al. (1999). DNA quality was checked using agarose gel electrophoresis and quantified using the NanoDrop™ spectrophotometer (NanoDrop Technologies, LLC, Wilmington, Delaware, USA) and the concentration adjusted accordingly before PCR amplification. In our study PCR amplifications were conducted using primers ITS1 and ITS4 described by White et al. (1990). The PCR products were verified by agarose gel electrophoresis and purified for direct PCR sequencing using ABI PRISM 377 automatic sequencer (Applied Biosystems, Foster City, CA, USA). Sometimes the PCR fragments are cloned before sequencing. Sequences were determined on both strands for each of the isolates and were aligned for comparison. Most sequence comparisons are carried out using BLASTn (<http://www.ncbi.nlm.nih.gov/BLAST>) analysis which aligns two or more homologues to detect for presence of one or more ambiguous region within the segments under comparison. Using nine isolates from *S. sclerotiorum* and *S. trifoliorum*, we amplified a 540 bp DNA fragment of the ITS region (Njambere et al. 2008). Sequence alignment among the nine isolates identified two single nucleotide polymorphic sites (SNPs) within this homologous region that differentiated the two groups of isolates. The two SNPs were located at position 120 (transversion T → G) and position 376 (transition T → C) of the amplicon. Three sequences of the isolates were deposited in the GenBank and assigned accession numbers EU082464, EU082465, and EU082466. BLASTn analysis of the ITS locus of some of the chickpea isolates (including EU082464, EU082465) displayed 100% homology to ITS locus of *S. trifoliorum* in the GenBank, whereas the ITS region of the other isolates (including EU082466) were identical to GenBank *S. sclerotiorum* isolates. These results therefore suggest that these two SNPs could be used as markers to separate *S. sclerotiorum* from *S. trifoliorum*. Although the ITS sequences allowed differentiation between *S. sclerotiorum* and *S. trifoliorum*, this technique is not convenient for routine identification because it requires DNA sequencing.

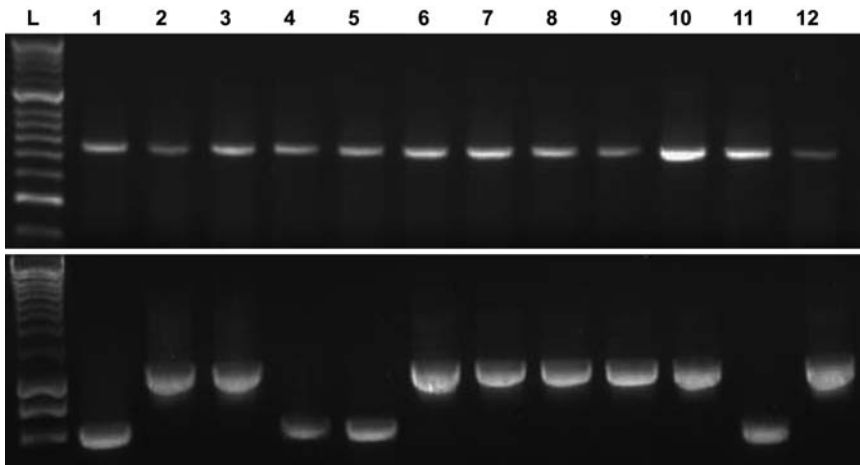
### 4.2.2 Detection of Group I Introns

Group I introns are ribozymes (RNA enzymes) that catalyze chemical reactions, splicing themselves off of their precursors. Group I introns are widely distributed in bacteria, lower eukaryotes, and higher plants. They can be found in genes encoding for rRNA, mRNA, and tRNA, but seem only in rRNA genes in the nuclear genome of lower eukaryotes. No biological functions are known for the group I introns except for splicing themselves off the primary transcripts. Although group I introns are known to spread from location to location and from one organism to another in evolutionary time, they are quite stable and their locations are highly conserved. Thus, if differences in existence of group I introns are found between two species,

the introns provide convenient markers for separation of the species because they can be easily detected through PCR and agarose gel electrophoresis. That is the case for *Sclerotinia* spp.

It was reported by Power et al. (2001) that *S. trifoliorum* contains group I introns in the nuclear small subunit rDNA, whereas *S. sclerotiorum* as well as *S. minor* does not contain group I introns in the same DNA region. We applied this knowledge in identifying *S. trifoliorum* from twelve isolates collected from chickpea plants. PCR amplifications were done using primer pairs ITS5/ITS4 and NS3/NS6 (White et al. 1990) in an attempt to detect presence or absence of introns in the nuclear small subunit regions of the rDNA. The reaction conditions were identical to those described above for PCR amplification of the ITS region. One or more group I introns were detected in all isolates of *S. trifoliorum*, and no group I introns were observed at any isolates of *S. sclerotiorum* (Fig. 4.2). Amplification with PCR can facilitate detection of the group 1 introns using PCR primer flanking the introns. Isolates with introns produce larger PCR products than isolates without introns, which can be easily detected using agarose gel electrophoresis (Fig. 4.2).

To be certain that the isolates harboring the group I introns are indeed *S. trifoliorum*, nine isolates were selected and induced to germinate carpogenically using a method as previously described (Njambere et al. 2008). For the isolates that germinated carpogenically, all the isolates that harbored introns in the rDNA region produced dimorphic ascospores, the ultimate criterion of identifying *S. trifoliorum* (Fig. 4.3). These confirmatory tests suggest that the group I introns in the rDNA region could be used for a quick and accurate identification of *S. trifoliorum* at



**Fig. 4.2** Agarose gels of PCR amplification of the ITS and the nuclear small subunit rDNA regions of *Sclerotinia* spp. PCR products with primer pairs ITS1 and ITS4 (*top*) are monomorphic in size (no introns), whereas PCR products with primers ITS4 and ITS5 (*bottom*) are polymorphic in size (due to presence of introns). The lanes 1, 4, 5, and 11: *S. sclerotiorum* isolates (without introns); Lanes 2, 3, 6, 7, 8, 9, 10, and 12: *S. trifoliorum* (with introns)



**Fig. 4.3** Ascospore morphology of *Sclerotinia trifolorum* (a and b) showing size dimorphism, and of *S. sclerotiorum* (c) showing no size dimorphism

species level. We have employed this technique in identifying more than 100 isolates of *S. trifolorum* for population genetic studies.

### 4.3 Powdery Mildew of Lentil

Powdery mildew is a plant disease caused by many different species of fungi in the order Erysiphales (Glawe 2008). The disease occurs in a wide range of plants. Its symptoms are very distinctive, powdery like spots on leaves and stems. The disease can reduce the yield and quality of many crops and commercial values of ornamental plants. In the field crop lentil, it can be a severe disease on certain cultivars and in some parts of the world, particularly in India during January to February (Agrawal and Prasad 1997). Although lentil is a field crop, breeding materials and many experimental plants are produced in greenhouses. Powdery mildew is a persistent disease problem of lentil plants in greenhouses (Beniwal et al. 1993), and poses a threat to precious breeding materials such as F1 plants. Infections by powdery mildews typically result in small white colonies on leaf surfaces (Fig. 4.1b). Lesions expand to cover entire leaf surfaces and pods. Mycelial growth and conidial production can be especially extensive at flowering. In case of severe

infections, leaves become chlorotic, then curled and necrotic prior to abscission. Yield decline may result and plants sometimes die (Agrawal and Prasad 1997).

Even though powdery mildew symptoms are easily recognized, identification of the species that causes the disease could be problematic (Glawe 2008). Knowing the species identity is important in devising management strategies as different species have different host ranges and different life histories. Identification of powdery mildew fungi relies on morphology of reproductive structures. Powdery mildews reproduce sexually by forming sexual structure chasmothecia (teleomorph) and asexually through conidia (anamorph). Traditional belief is that morphology of teleomorphs is more reliable than morphology of anamorphs. Taxonomy of powdery mildews of legumes is traditionally based on a few teleomorphic features, including chasmothecial appendage morphology (Braun 1995; Braun 1987) and host range. Powdery mildew pathogens that produce chasmothecia with multiple asci and dichotomously branched chasmothecial appendages were grouped into the genus *Microsphaera*, while otherwise similar, mycelioid appendage-bearing species were classified within the genus *Erysiphe* (Braun 1987).

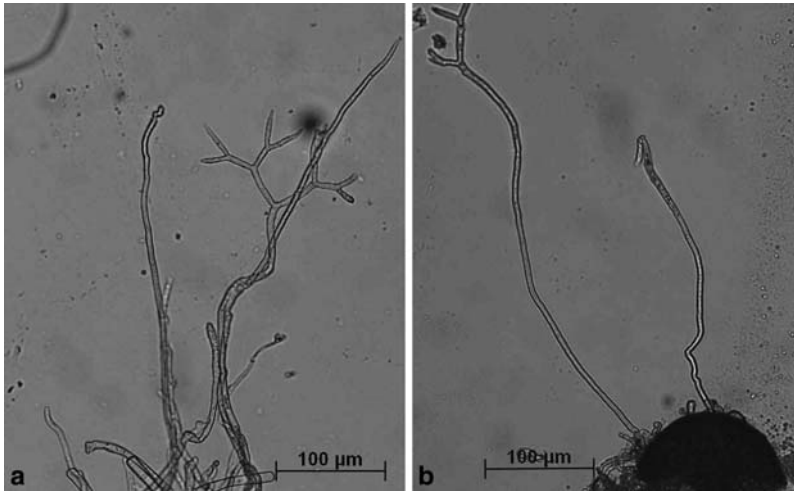
However, recent phylogenetic studies of powdery mildew fungi using ribosomal DNA sequences demonstrated that anamorphic features are more indicative of phylogenetic lineages than are teleomorphic features, and that anamorphic characters are of utility in species determination (Braun and Takamatsu 2000; Cunnington et al. 2003; Glawe 2008). Chasmothecial appendages traditionally used to distinguish genera are now used to distinguish species (Braun and Takamatsu 2000). However, teleomorphic state is not always available and most of the time it forms when plants are senescent late in the growing season or does not form at all. It prevents timely detection and identification of the pathogen species. Even though abundant conidia are produced early in the disease development, there are only few anamorphic characters available (such as morphology and dimensions of conidia and conidiophores) to describe species and most of them overlap among closely related species. For example, conidia shape and sizes of *E. pisi* and *E. trifolii* are very similar and overlap considerably. Likewise, it is not reliable to use host ranges to identify powdery mildew species because many of them have broad and overlapping host ranges (Amano 1986).

Accurate determination of the pathogen species is very important not only for managing the disease, but also in plant breeding programs because different resistance genes may confer resistance to different pathogen species (Epinat et al. 1993). In some instances several powdery mildew species have been reported to occur together on the same host (Epinat et al. 1993; Glawe et al. 2004; Mmbaga et al. 2004).

Recent advances in molecular techniques have made it possible to investigate the species level identification of lentil powdery mildew pathogens. Use of molecular characters, especially ITS sequence data, has given promising results for species determination in some powdery mildews (Braun and Takamatsu 2000; Cunnington et al. 2003; Mmbaga et al. 2004; Takamatsu et al. 2002).

Powdery mildew of lentil is reported to be caused by two *Erysiphe* species, *E. pisi* (Amano 1986), a common pathogen of pea, and *E. diffusa* (Banniza et al. 2004), a





**Fig. 4.4** Chasmothecium and its appendages of *E. trifolii* formed on an infected lentil plant. Highly branched chasmothecial appendages (a) and long flexuous nature of the chasmothecial appendages (b)

pathogen of soybean. The two species differ in conidia sizes. *E. pisi* produces conidia larger than those of *E. diffusa*. The major difference between the two species is that *E. diffusa* produces chasmothecial appendage with highly branched apices, whereas *E. pisi* produces mycelioid appendages. Powdery mildew is a frequent and serious disease of lentil plants in our greenhouses, but the species identity is not known. We observed that the conidia sizes larger than those described for *E. diffusa*. However, it produced chasmothecial appendages with regularly branched apices (Fig. 4.4), raising the possibility that it could be *E. diffusa*. The contradiction between the anamorphical characters and the teleomorphic characters gave confusion about the species identity. In order to ascertain the species identity of the powdery mildew fungus on lentil plants, we analyzed sequences of rDNA ITS region which led to the discovery of a new species of lentil powdery mildew.

### 4.3.1 Sample Collection and DNA Sequencing

Four samples of powdery mildews were collected from three different greenhouses over a 3-year period and an additional sample from the field was included in this study. Because *E. diffusa* is also a suspect species, a sample of *E. diffusa* from wild soybean (*Glycine* spp., kindly provided by Dr. Randall Nelson of USDA ARS, Urbana, Illinois, USA) was also included for comparison. Total DNA was isolated from conidia and/or mycelia from infected lentil plants using FastDNA® kit described by Chen et al. (1999). PCR amplification of the ITS region from each sample was performed using the primers ITS1 and ITS4 (White et al. 1990), or



*Erysiphe*- specific primers that we designed on the basis of conserved sequences of the ITS region of *Erysiphe* spp., EryF (5'TACAGAGTGCAGGCTCAGTCG3') and EryR (5'GGTCAACCTGTGATCCATGTGACTGG3') (Attanayake et al. 2009). Amplified DNA fragments were first cloned into plasmid pCR2.1TOPO (Invitrogen Crop, Calsbad, CA). Plasmids containing inserts were verified by restriction digestion. The inserts were sequenced from both strands using one of the six primers: EryF, EryR, ITS1, ITS4, M13F, and M13R at the Sequencing Core Facility of Washington State University.

### 4.3.2 Sequence Analysis

All the ITS sequences of lentil powdery mildews collected from greenhouses and the field used in this study were identical to one another, but they differed in 18 nucleotide positions from the sequence of *E. diffusa* from a wild soybean *Glycine* sp. (Fig. 4.5). Sequences were used in BLASTn searches against the GenBank database (<http://www.ncbi.nlm.nih.gov/BLAST>) to identify the most similar sequences available in the database. The sequences in the GenBank that showed the highest similarity (one base-pair difference) to the lentil powdery mildew sequence were three identical sequences (AB079853 to AB079855) of *E. trifolii*-like *Oidium* sp. from Japan (Okamoto et al. 2002). The sequences in the GenBank that showed the next highest similarity (three base pair differences) were five identical sequences (e.g., AB015913 and AF298542) of *E. trifolii* (Cunnington et al. 2003; Matsuda et al. 2005; Takamatsu et al. 1999), and another sequence (AB015933) of *E. baeumleri* (Takamatsu et al. 1999). The ITS sequence of the powdery mildew sample from wild soybean was identical to deposited sequences of *E. diffusa* in the GenBank.

Sequence accessions with high similarity values to the sequences determined in this study were aligned using the ClustalW program and used in phylogenetic analysis using the DNA Parsimony program of the PHYLIP package at <http://bioweb2.pasteur.fr/phylogeny/intro-en.html>. Parsimony analysis produced one most parsimonious tree with 113 steps. The sequence of lentil powdery mildew formed a tight cluster (monophyletic group) with sequences of *Erysiphe baeumleri*, *E. trifolii*, and *E. trifolii*-like *Oidium* spp., and is distantly related to (paraphyletic) *E. diffusa*. Another powdery mildew sequence from wild soybean specimen, also incorporated in this study, formed a separate clade with *E. diffusa* sequences in the GenBank.

### 4.3.3 Species Confirmation

As *E. trifolii* is not previously reported to be a pathogen of lentil, we needed to ascertain that the powdery mildew fungus on lentil is indeed *E. trifolii* and that it is

<i>E. trifolii</i>	GCCGACCCCTCCCACCCGTCGATTTGTATCTTGTGCTTTGGCGGGCCGGGCCGCGCTG	60
<i>E. diffusa</i>	GCCGACCCCTCCCACCCGTCGATTTGTATCTTGTGCTTTGGCGGGCCGGGCCGCGCTG	60
	*****	*
<i>E. trifolii</i>	TCGCTGTTTCGCAAGGACCTGCGTCGGCCGCCACC-GGTTTTGAACTGGAGCGCGCCCGC	119
<i>E. diffusa</i>	TTGCAGTCCGCATGGACATGCGTCGGCCGCCCGCCCGGTGTTCCACTGGAGCGCGCCCGC	120
	* * * * *	*****
<i>E. trifolii</i>	CAAAGACCCAACAAAACCTCATGTTGTTTGTGTCGCTCAGCTTTATTATGAAAATTGAT	179
<i>E. diffusa</i>	CAAAGACCCAACAAAACCTCATGTTGTTTGTATCGTCTCAGCTTTATTATGAAAATTGAT	180
	*****	*****
<i>E. trifolii</i>	AAAACCTTCAACAACGGATCTCTTGCTCTGGCATCGATGAAGAACGCAGCGAAATGCGA	239
<i>E. diffusa</i>	AAAACCTTCAACAACGGATCTCTTGCTCTGGCATCGATGAAGAACGCAGCGAAATGCGA	240
	*****	*****
<i>E. trifolii</i>	TAAGTAATGTGAATTGCGAATTTAGTGAATCATCGAATCTTTGAACGCACATTGCGCCC	299
<i>E. diffusa</i>	TAAGTAATGTGAATTGCGAATTTAGTGAATCATCGAATCTTTGAACGCACATTGCGCCC	300
	*****	*****
<i>E. trifolii</i>	CTTGGTATTCGAGGGGCATGCCTGTTTCGAGCGTCATAACACCCCTCCAGCTGCCTTTG	359
<i>E. diffusa</i>	CTTGGTATTCGAGGGGCATGCCTGTTTCGAGCGTCATAACACCCCTCCAGCTGCCTTTG	360
	*****	*****
<i>E. trifolii</i>	TGTGGCTGCGGTGTTGGGGCACGTGCGCATGCGCGGCCCTTAAAGACAGTGGCGGTCCC	419
<i>E. diffusa</i>	TGTGGCTGCGGTGTTGGGGCTCGTCGCGATGCGCGGCCCTTAAAGACAGTGGCGGTCCC	420
	*****	*****
<i>E. trifolii</i>	GGCGTGGGCTCTACGCGTAGTAACTTGCTTCTCGCAGACAGAGTGACGACGGTGGCTTGCC	479
<i>E. diffusa</i>	GACGTGGGCTCTACGCGTAGTAACTTGCTTCTCGCAGACAGAGTGACGACGGTGGCTTGCC	480
	* *****	*****
<i>E. trifolii</i>	AGAACACCCCTCTTTTGCTCCAGTCACATGGATCACAGTTGACC	524
<i>E. diffusa</i>	AGAACAACCCCTCTTTTGCTCCAGTCACATGGATCACAGTTGACC	525
	*****	*****

**Fig. 4.5** Alignment of ITS sequences of *E. trifolii* and *E. diffusa* determined in this study. An asterisk indicates an identical base pair. There are 18 base-pair differences between the two sequences. The *E. trifolii* sequence is > 99% similar to previously deposited sequences of *E. trifolii* in GenBank, and the *E. diffusa* sequence is identical to previously deposited *E. diffusa* sequences in GenBank

pathogenic on lentil. Three experiments were carried out to confirm that the powdery mildew pathogen of lentil in the US is *E. trifolii*, and not *E. diffusa*. First, conidia of *E. trifolii* were collected from lentil and used in a detached leaf assay to determine the pathogenicity on lentil under controlled conditions. Second, an authentic species of *E. trifolii* was obtained and compared with the samples from lentil in the US. The experiment showed that *E. trifolii* does produce long flexuous chasmothecial appendages with regularly branched apices similar to lentil samples (Fig. 4.4a, b). Finally, as *E. diffusa* is a common pathogen of soybean, soybean genotypes “L84-2237” and “Harosoy” known to be susceptible to *E. diffusa* were inoculated with conidia of powdery mildew from lentil and grown side by side with infected lentil plants in the greenhouse. The lentil powdery mildew did not infect soybean plants during the entire life cycle of soybean. These evidences strongly support the conclusion that the powdery mildew pathogen found on lentil in US was *E. trifolii* (Attanayake et al. 2009).

Powdery mildews of plants in the Fabaceae are very complex and have begun to receive more and more attention. Further taxonomic studies are needed because *E. trifolii* has been regarded as a complex of similar species consisting of *E. trifolii*, *E. baeumleri* Magn., and *E. asteragali* DC. (Braun 1987). The nature of this complex needs to be verified.

## 4.4 Conclusions

Modern molecular techniques have been used for identifying fungi in a wide array of biological science disciplines. In this chapter, we presented two specific examples of how molecular techniques have helped solve practical problems in identifying fungal pathogens of cool season grain legumes. In one case, we used molecular markers (group I introns and ITS sequences) to differentiate *S. trifoliorum* from a more common and closely related species *S. sclerotiorum*. This technique of identification allowed us to determine the species identity without the time consuming process of inducing carpogenic germination and ascospore observation. This technique allowed us to identify more than 100 isolates for studies in population genetics of *S. trifoliorum*. In the second example, using rDNA ITS sequences we were able to identify a new pathogen (*E. trifolii*) of powdery mildew of lentil. There were some ambiguities in determining the species because the morphology of teleomorph resembled a previously reported species (*E. diffusa*), but the anamorph is clearly different from *E. diffusa*. By comparing ITS sequences, examining an authentic specimen of *E. trifolii* and conducting pathogenicity test of a common host of *E. diffusa*, we unequivocally determined that the lentil powdery mildew was caused by *E. trifolii*. In doing so, we actually broadened the taxonomical concept of the species *E. trifolii* to include regularly branched chasmothecial appendages. Using these two examples, we have shown that modern molecular technology plays an important role and has gained increasing widespread applications in solving practical problems in agriculture. Furthermore, similar to what was found in species of *Trichoderma* and *Hypocrea* (Druzhinina et al. 2005), our results showed that the ITS region and the adjacent rDNA could be ideal candidate DNA regions used for developing DNA barcodes for identifying these and related fungal species.

## References

- Agrawal SC, Prasad KVV (1997) Diseases of lentil. Science Publishers, Enfield, NH, pp 59–61
- Amano K (1986) Host range and geographical distribution of the powdery mildew fungi. Japan Scientific Societies Press, Tokyo, p 543
- Attanayake RN, Glawe DA, Dugan FM, Chen W (2009) *Erysiphe trifolii* causing powdery mildew of lentil (*Lens culinaris*). Plant Dis 93:797–803
- Banniza S, Parmelee JA, Morrall RAA, Tullu A, Beauchamp CJ (2004) First record of powdery mildew on lentil in Canada. Can Plant Dis Surv 84:102–103

- Beniwal SPS, Bayaa B, Weigand S, Makkouk KH, Saxena MC (1993) Field guide to lentil diseases and insect pests. International Center for Agricultural Research in the Dry Areas (ICARDA), Aleppo, Syria
- Braun U (1987) A monograph of the Erysiphales (Powdery Mildews). Beihefte zur Nova Hedwigia 89:1–700
- Braun U (1995) The powdery mildews (Erysiphales) of Europe. Gustav Fischer Verlag, New York, pp 1–307
- Braun U, Takamatsu S (2000) Phylogeny of *Erysiphe*, *Microsphaera*, *Uncinula* (Erysipheae) and *Cystotheca*, *Podosphaera*, *Sphaerotheca* (Cystothecaceae) inferred from rDNA ITS sequences – some taxonomic consequences. *Schlechtendalia* 4:1–33
- Bretag TW, Mebalds MI (1987) Pathogenicity of fungi isolated from *Cicer arietinum* (chickpea) grown in northwestern Victoria. *Aust J Exp Agric* 27:141–148
- Chen W, Gray LE, Kurlle JE, Grau CR (1999) Specific detection of *Phialophora gregata* and *Plectosporium tabacinum* in infected soybean plants. *Mol Ecol* 8:871–877
- Cother EJ (1977) Isolation of important fungi from seeds of *Cicer arietinum*. *Seed Sci Technol* 5:593–597
- Cunnington JH, Takamatsu S, Lawrie AC, Pascoe IG (2003) Molecular identification of anamorphic powdery mildews (Erysiphales). *Australas Plant Pathol* 32:421–428
- Druzhinina I, Kopchinskiy AG, Komon M, Bissett J, Szakacs G, Kubicek CP (2005) An oligonucleotide barcode for species identification in *Trichoderma* and *Hypocrea*. *Fungal Genet Biol* 42:813–828
- Epinat C, Pitrat M, Bertrand F (1993) Genetic analysis of resistance of five melon lines to powdery mildews. *Euphytica* 65:135–144
- Glawe DA (2008) The powdery mildews: a review of the world's most familiar (yet poorly known) plant pathogens. *Annu Rev Phytopathol* 46:27–51
- Glawe DA, du Toit LJ, Pelter GQ (2004) First report of powdery mildew on potato caused by *Leveillula taurica* in North America Online. *Plant Health Prog*. doi:10.1094/PHP-2004-1214-01-HN
- Henry T, Iwen PC, Hinrichs SH (2000) Identification of *Aspergillus* species using internal transcribed spacer regions 1 and 2. *J Clin Microb* 38(4):1510–1515
- Holst-Jensen A, Vaage M, Schumacher T, Johansen S (1999) Structural characteristics and possible horizontal transfer of group I introns between closely related plant pathogenic fungi. *Mol Biol Evol* 16(1):114–126
- Kohn LM (1979) Delimitation of the economically important plant pathogenic *Sclerotinia* species. *Phytopathology* 69:881–886
- Lieckfeldt E, Seifert KA (2000) An evaluation of the use of ITS sequences in the taxonomy of the Hypocreales. *Stud Mycol* 45:35–44
- Matsuda Y, Sameshima T, Moriura N, Inoue K, Nonomura T, Kakutani K, Nishimura H, Kusakari S, Takamatsu S, Toyoda H (2005) Identification of individual powdery mildew fungi infecting leaves and direct detection of gene expression by single conidium polymerase chain reaction. *Phytopathology* 95:1137–1143
- Mmbaga MT, Klopfenstein NB, Kim MS, Mmbaga NC (2004) PCR-based identification of *Erysiphe pulchra* and *Phyllactinia guttata* from *Cornus florida* using ITS-specific primers. *For Pathol* 34:321–328
- Njambere EN, Chen W, Frate C, Wu BM, Temple S, Muehlbauer FJ (2008) Stem and crown rot of chickpea in California caused by *Sclerotinia trifoliorum*. *Plant Dis* 92:917–922
- Okamoto J, Limkaisang S, Nojima H, Takamatsu S (2002) Powdery mildew of prairie gentian: characteristics, molecular phylogeny and pathogenicity. *J Gen Plant Pathol* 68:200–207
- Power KS, Steadman JR, Higgins BS, Powers TO (2001) Intraspecific variation within North American *Sclerotinia trifoliorum* isolates characterized by nuclear small subunit rDNA introns. Proceedings of the XI International Sclerotinia Workshop, Central Science Laboratory, New York, UK

- Rehnstrom AL, Free SJ (1993) Methods for the mating of *Sclerotinia trifoliorum*. *Exp Mycol* 17:236–239
- Sanchez-Ballesteros J, Gonzalez V, Salazar O, Acero J, Portal MA, Julian M, Rubio V, Bills GF, Polishook JD, Platas G, Mochales S, Pelaez F (2000) Phylogenetic study of *Hypoxyton* and related genera based on ribosomal ITS sequences. *Mycologia* 92(5):964–977
- Schneider JHM, Salazar O, Rubio V, Keijer J (1997) Identification of *Rhizoctonia solani* associated with field grown tulips using ITS rDNA polymorphism and pectic zymograms. *Eur J Plant Pathol* 103:607–22
- Takamatsu S, Hirata T, Sato Y, Nomura Y, Sato Y (1999) Phylogenetic relationships of *Microspphaera* and *Erysiphe* section *Erysiphe* (powdery mildews) inferred from the rDNA ITS sequences. *Mycoscience* 40:259–268
- Takamatsu S, Shin HD, Paksiri U, Limkaisang S, Taguchi Y, Nguyen T-B, Sato Y (2002) Two *Erysiphe* species associated with recent outbreak of soybean powdery mildew: results of molecular phylogenetic analysis based on nuclear rDNA sequences. *Mycoscience* 43:333–341
- Uhm JY, Fujii J (1983a) Ascospore dimorphism in *Sclerotinia trifoliorum* and cultural characters of strains from different-sized spores. *Phytopathology* 73:565–569
- Uhm JY, Fujii J (1983b) Heterothallism and mating type mutation in *Sclerotinia trifoliorum*. *Phytopathology* 73:569–572
- White TJ, Bruns T, Lee S, Taylor J (1990) Amplification and direct sequencing of fungal ribosomal RNA genes for phylogenetics. In: Innis MA, Gelfand DH, Sninsky JJ, White TJ (eds) *PCR protocols: a guide to methods and applications*. Academic Press, San Diego, pp 315–322

# Chapter 5

## Quantitative Detection of Fungi by Molecular Methods: A Case Study on *Fusarium*

Kurt Brunner and Robert L. Mach

**Abstract** The determination of fungal biomass in diverse samples plays a key role for questions in the fields of plant pathology and agriculture. Until a decade ago, morphological strain determination and quantification by agar-plating methods were the only techniques to quantify fungal infections. These methods were elaborate and time consuming and the obtained results might not always reflect the biological situation. At the end of the 1990s, numerous groups all over the world started with the molecular characterization of the genus *Fusarium* and defined several diagnostic sequences in the genome of the most prominent *Fusarium* species as suitable for the discrimination of isolates. Based on these characteristic sequences originally applied for taxonomic studies, quantitative PCR assays were developed from the turn of the millennium until now. PCR tests for certain species were also developed as well as tests for whole groups producing a particular class of toxins. Until now real-time PCR based *Fusarium* determinations are applied predominantly in niches in agro-biotechnology. However, to further disseminate the inexpensive and rapid quantitative PCR, the quality of analysis has to be guaranteed by defining several standards concerning the PCR procedure from DNA isolation to data analysis. Additionally, plant breeders and agronomists are familiar with toxin analysis and visual rating systems. So change in people's mind is necessary to realize the benefits of a novel technique.

### 5.1 Introduction

Fungi of the genus *Fusarium* are worldwide occurring plant pathogens which cause severe damage to numerous cultivable plants (Weiland and Sundsbak 2000; Mirete et al. 2004; Youssef et al. 2007; Li et al. 2008) with the highest economical

---

K. Brunner and R.L. Mach

Institute of Chemical Engineering, Research Area Gene Technology and Applied Biochemistry, Gene Technology Group, Vienna University of Technology, Getreidemarkt 9, A-1060, Vienna  
e-mail: rmach@mail.zserv.tuwien.ac.at

losses upon infection of maize, wheat, and barley (Windels 2000; Njanje et al. 2004). *Fusarium*-caused diseases have the potential to destroy crops within several weeks and lead to quality losses in grains in two separate ways: besides the deficit due to reduced yield and kernel size (tombstone kernels), the fungus produces numerous toxic metabolites while colonizing the plant and thereby heavily impairs the quality of cereal grains used for the food and feed industry (Marcia McMullen et al. 1997). The acute or chronic toxicity of *Fusarium*-released compounds led to the introduction of national limits for mycotoxins in many nations or even to supranational applications of regulations (e.g., limits of the European Community since 2006).

Integrated control strategies are indispensable to fight *Fusarium* diseases in modern agriculture and only the combined effect of (1) planting highly resistant varieties, (2) reasonable crop rotations, and (3) suitable tillage systems can minimize the damages caused by this destructive fungus. Although the knowledge about the *Fusarium* life-cycle and infection paths increased dramatically, biologic difficulties and economic or ecologic interests prevent achieving sustainable success in controlling these pathogenic fungi: throughout the last decade, plant breeders made substantial progress in the development of *Fusarium*-tolerant maize and wheat cultivars by identifying genetic regions which are linked to the resistance of plants (Anderson et al. 2001; Medianer 2006; Robertson-Hoyt et al. 2006). However, the resistance against *Fusarium* is spread over several distinct genetic regions (quantitative trait loci, QTLs) in the plant genome and the breeding of highly resistant plants is elaborate and time-consuming. The severity of infections due to the nonavailability of completely resistant plants is further increased by applying unsuitable cropping systems. The influence of crop rotations on the severity of *Fusarium* head blight was investigated in several studies (Petcu and Ionibã 1998; Reid et al. 2001) and the economically most lucrative cultivation of alternating maize and wheat specially turned out to be problematic. *Fusarium* nonhost plants as preceding crops of wheat and maize or as intercrops are often less profitable and thereby of low interest to farmers. Erosion causes a dramatic loss of fertile topsoil, especially in North and South America, and no-till systems have been established in endangered areas to overcome the drawback of conventional farming. Although reduced tillage systems prevent the loss of topsoil, *Fusarium* inoculum density in the soil increases compared to plow treated fields (Steinkellner and Langer 2004). According to the data of the United Nations Food and Agriculture Organization, more than 250,000 km<sup>2</sup> of US farmland are cultivated with no-till methods, closely followed by Brazil, Argentina, and Canada. In addition to the above mentioned factors other uncontrollable factors like the weather conditions at time periods crucial for infections play a key role in affecting the produce. Due to these complex interacting criteria no management systems could be established allowing a complete prevention of *Fusarium* infection of field crops to avoid mycotoxins in the food and feed chain. As the *Fusarium* problem in agriculture is not supposed to be overcome within the near future, elaborate monitoring programs have been started in many countries with the aim of observing mycotoxin patterns and fungal population dynamics in selected areas.

The traditional method used to isolate and characterize fungi is the cultivation on particular media and microscopic investigations. These conventional identification methods are very time-consuming and have to be performed by skilled personnel to prevent incorrect identification and data interpretation. Moreover, conventional methods used for fungal detection are predominantly semi quantitative by determining the colony forming units from surface sterilized grains plated on particular solid media (Cantalejo et al. 1998; Krysinska-Traczyk et al. 2007). To overcome the drawbacks of culture based identifications, throughout the last decade rapid screening technologies based on DNA identification have been developed and are nowadays well established for *Fusarium* species. In contrast to conventional detection methods, samples can be tested directly without any elaborate isolation and cultivation steps for a proper classification. These novel identification or discrimination methods include PCR based technologies like DGGE, AFLP, or RFLP and also diagnostic microarrays. All these methods are relatively insensitive to microbial backgrounds and non target organisms.

## 5.2 Quantification Strategies

The broad application of DNA-based identification technologies increased the knowledge on diagnostic DNA fragments of *Fusarium* species: ITS or IGS sequences (Mishra et al. 2003; Gagkaeva and Yli-Mattila 2004; Konstantinova and Yli-Mattila 2004; Mirete et al. 2004; Yli-Mattila et al. 2004a, b; Jurado et al. 2006; Kulik 2008), mitochondrial DNA (Láday et al. 2004a, b), the  $\beta$ -tubulin encoding gene (Gagkaeva and Yli-Mattila 2004; Mach et al. 2004; Yli-Mattila et al. 2004b), the translation elongation factor gene (Knutsen and Holst-Jensen 2004), and the calmodulin gene (Mulè et al. 2004) were sequenced from numerous *Fusarium* spp. to allow the design of highly specific PCR primers. On the other hand, the genes from biosynthesis pathways for mycotoxins (Niessen and Vogel 1998; Bakan et al. 2002; Lee et al. 2001; González-Jaén et al. 2004; Nicholson et al. 2004; Bezuidenhout et al. 2006; Baird et al. 2008) were studied accurately to distinguish between producers and nonproducers of certain toxins.

The sequence information gained throughout the different molecular taxonomic investigations and population studies forms a broad basis not only for qualitative applications but increasingly for quantitative detection methods. Although different techniques like DGGE, RFLP, and AFLP were applied for the qualitative identification of targets, only the real-time PCR tended to be practicable for quantitative detection methods.

### 5.2.1 Competitive PCR

The first steps toward *Fusarium* quantification were made around 2000. As real-time PCR technique was still in its infancy, competitive PCR was a common tool to gain information on initial amounts of target DNA in samples.



Nicholson et al. (1998) designed primer pairs specific to either *F. graminearum* or *F. culmorum* from RAPD analysis and optimized the reaction for competitive quantification. The *F. culmorum* species-specific competitive PCR assay was used to study the effect of inoculum load and timing on stem base disease of winter wheat caused by *F. culmorum*. The extent of fungal colonization, as measured by fungal DNA content, was greater on plants inoculated earlier in the season and increased with increasing conidial load. The *F. graminearum*-species specific competitive PCR assay was used to study the colonization of wheat grain by different trichothecene producing and nonproducing isolates of *F. graminearum*.

Edwards et al. (2001) were the first to quantify toxin producing *Fusarium* species based on the presence of a diagnostic fragment of a key gene for trichothecene biosynthesis. The trichodiene synthase encoding gene *tri5* is essential for the first step in trichothecene synthesis and is found only in toxin producing strains. The authors demonstrated a good correlation ( $r^2 = 0.76$ ) between the deoxynivalenol (DON) concentrations in winter wheat and the competitive PCR determined fungal biomass. In contrast to visual ratings which do not frequently correlate with DON concentrations (Hussein et al. 1991), the PCR method turned out to be suitable as a rapid test for toxin concentration. The competitive PCR technique was applied to test the efficiency of seven different fungicides for their potential to reduce *Fusarium* biomass if compared to untreated controls.

## 5.2.2 Real-Time PCR

With the availability of reliable and affordable real-time PCR cyclers this novel technique found its way into the quantitative detection of plant pathogens including numerous *Fusarium* species. Real-time PCR has several advantages over competitive PCR: the dynamic range of real-time PCR is usually five to six orders of magnitude rather than two for competitive assays. Furthermore, postreaction processing like gel electrophoresis is unnecessary and thereby the real-time detection of fluorescence saves time and a higher throughput is possible. By using probes with different fluorescent reporter dyes, amplification of more PCR products can be used to detect different strains, polymorphisms, or even single point mutations in a single tube. For the quantification of *Fusarium* in general, two different approaches for the design of specific qPCR assays were chosen: (1) the determination of one particular *Fusarium* species with a focus on selectivity to allow the quantification of the target even in a background of highly similar isolates, and (2) the simultaneous quantification of all strains which produce certain toxins like trichothecenes or fumonisins, based on genes involved in the biosynthesis of these metabolites.

### 5.2.2.1 Species Specific Quantification

Reischer et al. (2004) developed a TaqMan based PCR assay for *F. graminearum* which is the most prevalent species found in moderate climate zones. The method

targets the  $\beta$ -tubulin encoding gene *tub1* which was isolated from nine Austrian *F. graminearum* isolates and the sequence was aligned with 144 *tub1* sequences from the closely related species *F. culmorum*, *F. poae*, *F. pseudograminearum*, *F. sporotrichioides*, *F. cerealis*, and *F. lunulosporum* to guarantee the specificity of the test. The method developed in this study allows a fast, species-specific identification and quantitation of plant-infections by *F. graminearum* at very early stages where classical microbiological methods failed to detect the pathogen. The authors demonstrated that five copies of the *tub1* gene were sufficient for reliable quantification. The method can be applied on DNA extracted directly from infected plant material and is not affected by any unspecific background of either plant or fungal DNA, even from other pathogens causing head blight.

Other TaqMan-based species specific PCR assays were developed for *F. graminearum*, *F. poae*, *F. culmorum*, or *F. avenaceum* (Waalwijk et al. 2004), the predominant species associated with head blight in Europe. The applied primer pairs were designed from RAPD fragments previously developed (Nicholson et al. 1998) or taken from a previous study (Waalwijk et al. 2003). For all species, the level of quantification was below 1 pg of genomic DNA (what corresponds to 25 fungal genomes) and all assays showed a dynamic range of at least four magnitudes. Based on these quantitative tests, a comprehensive monitoring of the *Fusarium* community in the Netherlands was performed in 2001 and 2002. Forty wheat fields well distributed all over the country were chosen for analysis and most samples turned out to be infected with a mix of different *Fusarium* species with *F. graminearum* occurring as the most prominent one. The authors clearly demonstrated the advantage of reliable PCR systems combined with a high-throughput DNA extraction method over morphologic based monitoring. In contrast to conventional agar-plating techniques, the different fungal species can be quantified and usually the analyses are less time-consuming. In general, the PCR results and the data obtained by classic microscopy were quite similar but significant discrepancies were observed for several samples. The authors suppose that these differences were due to the major advantage of DNA based detection methods: the high stability of DNA allows detection of the fungal biomass that was produced during the infection of a kernel, irrespective of whether it stems from live or dead cells. Agar plate-based investigations depend on intact organisms for successful detection. Interestingly, in this study a nonlinear correlation between the fungal DNA and the DON content of samples was observed, which is in contrast to other publications (Schnerr et al. 2002; Fredlund et al. 2008; Yli-Mattila et al. 2008). However, this effect might also result from low extraction efficiencies of the weak infected kernels.

Another quantitative PCR assay has been developed recently to quantify *Fusarium solani* (Li et al. 2008), a soil-borne fungus that infects soybean roots and causes sudden death syndrome. The goal of this study was to develop a real-time quantitative assay to compare the accumulation of genomic DNA among 30 *F. solani* isolates in inoculated soybean roots. The small subunit of the ribosomal RNA gene was chosen as PCR target and a dual labeled TaqMan probe was designed to ensure the specificity of the method. The authors demonstrated the correlation

between colony forming units and DNA amount in infected root tissue. This qPCR approach provides useful information for evaluating the aggressiveness of isolates based on the degree of colonization on soybean roots and for selecting *F. solani* resistant soybean lines.

A comprehensive study on real-time PCR detection of different *Fusarium* species was published only recently (Yli-Mattila et al. 2008). Quantitative tests for *F. graminearum* and *F. poae* were developed and the correlation of fungal biomass to the production of certain toxic metabolites was demonstrated. *F. poae* and *F. langsethiae* are morphologically almost indistinguishable but the two fungi produce a different spectrum of toxins and thereby microbiologic infection studies can easily lead to misestimating the toxin content of samples. Primers were designed based on a worldwide sequence collection of IGS sequences of *F. poae*, *F. sporotrichioides*, *F. langsethiae*, and *F. kyushuense* isolates to exclusively amplify the *F. poae* fragment. Selective primers for *F. graminearum* were obtained from the sequences of the IGS regions of Finnish *F. graminearum* isolates. Subsequently, the *F. poae* specific assay was designed for use in a quantitative multiplex PCR together with a *F. langsethiae*/*F. sporotrichioides* specific primer and probe combination. The application of multiplex PCR allows the quantification of all strains in a single run and thus lowers the costs and increases the throughput of analysis. To date this is the only published quantitative multiplex tests for *Fusarium* species. Additionally, the authors included the *tox5* assay (Schnerr et al. 2001) in their monitoring study and compared the respective PCR results with microbiologic determined contamination levels and the toxin content of cereal grains. A correlation was found between the levels of *F. poae* DNA and nivalenol and enniatins in barley and between the levels of *F. graminearum* DNA and DON in oats. The correlations between *F. poae* DNA and nivalenol and *F. graminearum* DNA and DON levels were significantly higher than those between the mycotoxins and morphologically determined *Fusarium* contamination levels.

### 5.2.2.2 Group Specific Quantification Based on the Detection of Toxin Biosynthesis Genes

Frequently quantitative PCR tests are based on toxin biosynthesis key-genes as targets for amplification. In contrast to the species specific assays, a whole group of *Fusarium* spp. that is able to produce a certain class of mycotoxins is quantified in a single run, regardless of their taxonomic belonging. For many applications these types of PCR quantification might be of greater interest, as in general a good correlation between fungal biomass and the toxins in a sample is given.

Most assays developed throughout the last decade focus on trichothecene producing species as this class of metabolites turned out to be most relevant for human and animal health due to their acute toxicity. The biosynthetic pathway has previously been studied and one enzyme turned out to be a kind of key step for biosynthesis of all trichothecenes. The trichodiene synthase catalyzes the initial reaction to form trichodiene (Desjardins et al. 1993). The corresponding gene *tri5* is

located together with ten other genes for this pathway within the trichothecene cluster. This cluster is exclusively present in fungi with the capacity to produce class A and/or class B trichothecenes (Desjardins et al. 1993). The first *tri5* real-time PCR assay was published by Schnerr et al. (2001) with the *tox5* primers which were previously used for a group specific qualitative detection of toxin producers (Mulfinger et al. 2000). The test was applied to 30 wheat samples with infections of 0–78% of the kernels. Interestingly, the PCR method showed a high correlation to microbiological quantification of the infection by the plate counting method. However, for several samples the detected *Fusarium* DNA was much higher or lower than expected from the plate method. This effect is most probably due to the problem that microbiological methods can only count the number of infected kernels but give no hint of the severity of the *Fusarium* infection on a particular kernel. The intriguing question of the correlation of *Fusarium* DNA and produced toxins was further investigated in another study by the same authors (Schnerr et al. 2002). Three hundred wheat samples with DON concentrations between not detectable and 34.3 ppm were tested. Data analysis revealed a correlation coefficient of 0.96 between DON content and DNA amounts. In general the correlation appeared to be better at higher infection levels. This might have biological reasons as certain amounts of DON can be metabolized by the plants to DON-3-glucoside (Berthiller et al. 2005) and/or the efficiency of the DNA extraction varies more at lower *Fusarium* DNA-concentrations.

Strausbaugh et al. (2005) investigated the pathogenicity of *Fusarium* spp. frequently isolated from wheat and barley roots in southern Idaho during four growth-chamber experiments and two field studies. A real-time PCR assay for quantifying the presence of *F. culmorum* from infected root tissue was developed based on nucleotide sequence for the *tri5* gene. In contrast to previous studies (Schnerr et al. 2001, 2002) this test targeted highly variable regions of the *tri5* gene to allow specific *F. culmorum* tests. The TaqMan-based assay is able to quantify *F. culmorum* in root tissue down to 61 pg of total extracted DNA. Nevertheless, as the *tri5* gene is highly conserved among the trichothecene producing strains, the assay also detected *F. pseudograminearum* and *F. graminearum* and could not distinguish between these three *Fusarium* species.

Besides the class of trichothecenes, some *Fusarium* species secrete another threatening class of toxins. Especially in warmer climates the fumonisins produced mainly by *F. verticillioides* and *F. proliferatum* are found on maize but rarely on other cereals. The fumonisin biosynthetic genes are clustered (Proctor et al. 2003), and one of these genes, *fum1*, encodes for a polyketide synthase and was found to be indispensable for fumonisin biosynthesis (B18: Proctor et al. 1999). All quantitative assays for fumonisin producers published up to now focused on the detection of *fum1*. Bluhm et al. (2004) were the first researchers who used real-time PCR for the group specific detection of fumonisin producers. Nevertheless, instead of proper quantification, the assay was designed and applied to control a certain threshold limit of these strains in barley and maize samples. Another *fum1* based quantitative PCR assay was used to study the contamination of more than 420 maize samples from South African farms with fumonisin-toxigenic species (Waalwijk et al. 2008).

**Table 5.1** Overview of quantitative real-time PCR tests for *Fusarium* species

Target species	Diagnostic sequence	Reference
<i>F. graminearum</i>	<i>tub1</i>	Reischer et al. (2004)
<i>F. avenaceum</i> , <i>F. culmorum</i> , <i>F. graminearum</i> , <i>F. poae</i>	RAPD-derived	Waalwijk et al. (2004)
<i>F. solani</i>	small subunit of ribosomal RNA	Li et al. (2008)
<i>F. graminearum</i> , <i>F. poae</i>	IGS	Yli-Mattila et al. (2008)
Trichothecene producers	<i>tri5</i>	Schnerr et al. (2001)
<i>F. culmorum</i> , <i>F. graminearum</i> , <i>F. pseudograminearum</i>	<i>tri5</i>	Strausbaugh et al. (2005)
Fumonisin producers	<i>fum1</i>	Bluhm et al. (2004)
Fumonisin producers	<i>fum1</i>	Waalwijk et al. (2008)

The TaqMan based test detected *F. verticillioides*, *F. proliferatum*, *F. nygami*, and *F. globosum*. Notably, fumonisin nonproducers of *F. verticillioides* gave no response. The PCR determined DNA amount was compared with the ELISA-based measurements of fumonisin content and a correlation coefficient of 0.87 demonstrated the potential of this method for estimating the toxin content. Table 5.1 shows a summary of previously published quantitative real-time PCR based tests for various plant pathogenic *Fusarium* species.

### 5.2.3 DNA-Arrays

In many research areas microarray techniques gained a great deal of attention with the growing amount of genetic information of genera and species. Microarrays have the potential to rapidly identify DNA of different origin. In general, the hybridization methods are applied as high throughput systems but the accuracy of quantification is mostly low compared to real-time PCR analysis. A qualitative oligonucleotide array for the differentiation of toxigenic and nontoxigenic *Fusarium* isolates was developed by Nicolaisen et al. (2005). Until now only a single array based method for the quantitative detection of *Fusarium* species is available (Kristensen et al. 2007). The capture-oligo sequences for several trichothecene or moniliformin producing groups were designed based on the *tefl* sequence and 15 species can be quantified in a single run. Three different capture-probes, each spotted as triplets were included for each species to guarantee the specificity of the assay. The *Fusarium* chip showed a linear response to diluted *Fusarium* DNA of more than two magnitudes and the authors proposed a limit of quantification below 16 haploid *Fusarium* genomes. Barley, oat, wheat, and spelt samples were analyzed morphologically for toxin content and for the species pattern using the array. The results obtained by the novel hybridization method corresponded well with the established analyzes. Although a dilution series was tested to demonstrate the quantification capability of the microarray, all field samples were only tested for the absence or presence of certain species.

### 5.3 Conclusion

The quantitative determination of fungal infections is a useful tool in plant pathology for obtaining information on the aggressiveness of different isolates (Li et al. 2008), for *Fusarium* monitoring in agricultural practice, for testing fungicide efficiencies (Edwards et al. 2001) and has also been used for quality control of wheat, maize, and barley (Schnerr et al. 2001). Microbiologic and morphologic methods are time consuming – usually 7–21 days, depending on the isolates – and furthermore the accuracy of the results depends highly on skilled personnel experienced in microscopic differentiation of strains. Furthermore, the classic plate counting assays to determine colony forming units are often unable to accurately reflect the amount of fungal biomass that earlier led to the infection of plants as they depend on living organisms. In cereal grains the infection and the spread of the pathogen occurred usually 3–7 weeks before harvest. DNA is a relatively stable biomolecule and therefore represents an optimal target for gaining information on past stages of infection. Hence, the quantitative PCR is a brilliant tool for plant pathology related studies because it takes into account living mycelia actively producing toxins and also dead mycelia, which previously led to a certain grade of damage and/or had contributed to the toxin amount found in a sample.

Besides microbiologic determination, the analysis of toxins is an established method to gain information about the severity of an infection. Usually expensive HPLC or MS approaches are used to get reliable results. Although these methods are state of the art in mycotoxin analysis, the cost is extremely high and throughput limited. Since more and more countries introduced limits for toxin content in food and feed stuff, a market for commercial ELISA based tests systems was created. However, rapid tests often miss high accuracy and sample preparation is still time consuming. For the control of national mycotoxin limits the precise knowledge of the toxin content is indispensable. In contrast, for plant pathology and agriculture the concentration of a certain metabolite might not be of real interest but until a few years ago toxin tests were the best methods for gaining information about the grade of infection. Or – even worse – taking into account the toxins can only lead to false interpretation of data. Berthiller et al. (2005) demonstrated the high potential of plants to metabolize DON into deoxynivalenol-3-glucoside (D3G) which is reconverted into DON in the gastro-intestinal tract of mammals. Nowadays there are strong hints that *Fusarium* resistance breeding heads directly toward the potential of plants to hide fungal toxins like glucosides. Moreover, to save costs these analyzes are only rarely integrated in monitoring projects or in resistance determination of newly bred cultivars.

Although several studies demonstrated impressive correlations between *Fusarium* DNA and the mycotoxin concentration in cereal samples, real-time PCR can only roughly estimate the concentration of these compounds and therefore until now is unsuitable for official controls of food and feed. In contrast to food and feed analysis, the power of this method is found in all niche applications where the fungal biomass plays a key role: (1) quantitative PCR can be used to completely

substitute morphological analysis from the national *Fusarium* monitoring projects. In a few PCR runs, numerous species can be detected and for the most prominent strains quantitative assays are available which allow even the analysis of grains with mixed infections. Nevertheless, many studies have been performed with a relatively small subset of reference strains. Therefore over-regional applicability of the tests has to be verified and probably the specificity must be further optimized. (2) Tests for fungicide efficiency can easily be monitored with quantitative PCR. The determination of the DNA amount that caused the disease symptoms in comparison to untreated controls precisely reflects the grade of efficiency of a certain pesticide against *Fusarium*. The molecular analysis is inexpensive compared to HPLC/MS measurements. (3) Plant breeding and resistance evaluation (including tests for the national approval of cultivars) might be a field with high potential for real-time analysis. Although visual rating systems are well established by plant breeders, this method is elaborate as numerous ears are investigated at several time-points and the grade of infection is plotted against time. A molecular determination of fungal biomass in infected plants is cheaper than any other method and the results are not influenced by any metabolized – and thereby “hidden” – toxins.

In general, real-time PCR provides an invaluable potential to facilitate and cheapen analysis in fields like agriculture and plant breeding. However, as the method is still rather in its infancy, there are many problems to be solved in the near future. Until now no validated reference DNA is available on the market. Research groups isolate fungal DNA according to different protocols and use different approaches to determine DNA concentration (e.g., fluorimetric or photometric methods) which do not always give the same results. Furthermore DNA extraction protocols for cereal samples vary from study to study and until now no generally accepted reference method has been introduced. Only recently (Fredlund et al. 2008) the efficiencies of different protocols were compared and almost tenfold differences concerning the concentration of fungal DNA and coextracted PCR inhibitors were revealed. Combining the errors derived from inappropriate DNA-standard concentration measurement with the differences introduced by various DNA extraction protocols makes interlaboratory comparisons of results impossible. Until now no studies with ring-trials or even laborious method evaluations (e.g., repeatability, reproducibility, ruggedness etc.) are available. In general, suggestions for quality assurance for real-time PCR in agro-biotechnology made only recently (Lipp et al. 2005) should be considered as a good approach to increase the quality of analysis and raise the confidence of potential users of this novel technique. A change in people’s mindset – away from established methods – will be necessary to gain high acceptance of the quantitative PCR technique as a useful application for particular applications in plant pathology and agriculture.

**Acknowledgments** The present article was generated in the course of a *Fusarium* research project financed by the Austrian Federal Ministry of Agriculture, Forestry, Environment, and Water Management, project code FP100053.



## References

- Anderson JA, Stack RW, Liu S, Waldron BL, Fjeld AD, Coyne C, Moreno-Sevilla B, Fetch J, Mitchell M, Song QJ, Cregan PB, Frohberg RC (2001) DNA markers for *Fusarium* head blight resistance QTLs in two wheat populations. *Theor Appl Genet* 102(8):1164–1168
- Baird et al (2008) Identification of select fumonisin forming *Fusarium* species using PCR applications of the Polyketide Synthase gene and its relationship to fumonisin production in vitro. *Int J Mol Sci* 9(4):554–570
- Bakan B, Giraud-Delville C, Pinson L, Richard-Molard D, Fournier E, Brygoo Y (2002) Identification by PCR of *Fusarium culmorum* strains producing large and small amounts of deoxynivalenol. *Appl Environ Microbiol* 68(11):5472–5479
- Berthiller F, Dall'Asta C, Schuhmacher R, Lemmens M, Adam G, Krska R (2005) Masked mycotoxins: determination of a deoxynivalenol glucoside in artificially and naturally contaminated wheat by Liquid Chromatography-Tandem Mass Spectrometry. *J Agric Food Chem* 53:3421–3425
- Bluhm BH, Cousin MA, Woloshuk CP (2004) Multiplex real-time PCR detection of fumonisin-producing and trichothecene-producing groups of *Fusarium* species. *J Food Prot* 67(3): 536–543
- Bezuidenhout CC, Prinsloo M, Van der Walt AM (2006) Multiplex PCR based detection of potential fumonisin-producing *Fusarium* in traditional African vegetables. *Inc Environ Toxicol* 21:360–366
- Cantalejo MJ, Carrasco JM, Hernandez E (1998) Incidence and distribution of *Fusarium* species associated with feeds and seeds from Spain. *Rev Iberoam Micol* 15:36–39
- Desjardins AE, Hohn TM, McCormick SP (1993) Trichothecene biosynthesis in *Fusarium* species: chemistry, genetics, and significance. *Microbiol Rev* 57(3):595–604
- Edwards SG, Progozliev SR, Hare MC, Jenkinson P (2001) Quantification of trichothecene producing *Fusarium* species in harvested grain by competitive PCR to determine efficiencies of fungicides against *Fusarium* head blight of winter wheat. *Appl Environ Microbiol* 67(4):1575–1580
- Fredlund E, Gidlund A, Olsen M, Börjesson T, Spliid NHH, Simonsson M (2008) Method evaluation of *Fusarium* DNA extraction from mycelia and wheat for down-stream real-time PCR quantification and correlation to mycotoxin levels. *J Microbiol Methods* 73:33–40
- Gagkaeva TY, Yli-Mattila T (2004) Genetic diversity of *Fusarium graminearum* in Europe and Asia. *Eur J Plant Pathol* 110:551–562
- González-Jaén MT, Mirete S, Patiño B, López-Errasquín VC (2004) Genetic markers for the analysis of variability and for production of specific diagnostic sequences in fumonisin-producing strains of *Fusarium verticillioides*. *Eur J Plant Pathol* 110:525–532
- Hussein HM, Baxter M, Andrew IG, Franich RA (1991) Mycotoxin production by *Fusarium* species isolated from New Zealand maize fields. *Mycopathologia* 113:506–511
- Jurado M, Vázquez C, Sanchis V, González-Jaén MT (2006) PCR-based strategy to detect contamination with mycotoxigenic *Fusarium* species in maize. *Syst Appl Microbiol* 29:681–689
- Knutsen AK, Holst-Jensen A (2004) Phylogenetic analyses of the *Fusarium poae*, *Fusarium sporotrichioides* and *Fusarium langsethiae* species complex passed on partial sequences of the translation elongation factor-1 alpha gene. *Int J Food Prot* 95:287–295
- Konstantinova P, Yli-Mattila T (2004) IGS-RFLP analysis and development of molecular markers for identification of *Fusarium poae*, *Fusarium langsethiae*, *Fusarium sporotrichioides* and *Fusarium kyushuense*. *Int J Food Microbiol* 95:321–331
- Kristensen R, Gauthier G, Berdal KG, Hamels J, Holst-Jensen A (2007) DNA microarray to detect and identify trichothecene- and moniliformin-producing *Fusarium* species. *J Appl Microbiol* 102:1060–1070
- Krysinska-Traczyk E, Perkowski J, Dutkiewicz J (2007) Levels of fungi and mycotoxins in the samples of grain and grain dust collected from five various cereal crops in eastern Poland. *Ann Agric Environ Med* 14:159–167



- Kulik T (2008) Detection of *Fusarium tricinctum* from cereal grain using PCR assay. *J Appl Genet* 49(3):305–311
- Láday M, Juhász A, Moretti A, Szécsi A, Logrieco A (2004a) Mitochondrial DNA diversity and lineage determination of European isolates of *Fusarium graminearum*. *Eur J Plant Pathol* 110:545–550
- Láday M, Mulè G, Moretti A, Hamari Z, Juhász A, Szécsi A, Logrieco A (2004b) Mitochondrial DNA variability in *Fusarium proliferatum* (*Gibberella intermedia*). *Eur J Plant Pathol* 110:563–571
- Lee T, Oh D, Kim H, Lee J, Kim Y, Yun S, Lee Y (2001) Identification of deoxynivalenol and nivalenol-producing chemotypes of *Gibberella zeae* by using PCR. *Appl Environ Microbiol* 67(7):2966–2972
- Li S, Hartman GL, Domier LL, Boykin D (2008) Quantification of *Fusarium solani* f. sp. *glycines* isolates in soybean roots by colony-forming unit assays and real-time quantitative PCR. *Theor Appl Genet* 117:343–352
- Lipp M, Shillito R, Giroux R, Spiegelhalter F, Charlton S, Pinero D, Song P (2005) Polymerase chain reaction technology as analytical tool in agricultural biotechnology. *J AOAC Int* 88(1):136–155
- Mach RL, Kullnig-Gradinger CM, Farnleitner AH, Reischer G, Adler A, Kubicek CP (2004) Specific detection of *Fusarium langsethiae* and related species by DGGE and ARMS-PCR of a  $\beta$ -tubulin (*tub1*) gene fragment. *Int J Food Prot* 95:333–339
- Marcia McMullen M, Jones R, Gallenberg D (1997) Scab of wheat and barley: a re-emerging disease of devastating impact. *Plant Dis* 81(12):1340–1348
- Medianer T (2006) Breeding wheat and rye for resistance to *Fusarium* diseases. *Plant Breed* 116(3):201–220
- Mirete S, Vazquez C, Moulè G, Jurado M, Gonzáles-Jaén MT (2004) Differentiation of *Fusarium verticillioides* from banana fruits by IGS and EF-1 $\alpha$  sequence analysis. *Eur J Plant Pathol* 110:525–523
- Mishra PK, Fox RTV, Culham A (2003) Development of a PCR-based assay for rapid and reliable identification of pathogenic Fusaria. *FEMS Microbiol Lett* 218:329–332
- Mulfinger S, Niessen L, Vogel RF (2000) PCR based quality control of toxigenic *Fusarium* spp. in brewing malt using ultrasonication for rapid sample preparation. *Adv Food Sci* 22:38–46
- Mulè G, Susca A, Stea G, Moretti A (2004) A species specific PCR assay based on the calmodulin partial gene for identification of *Fusarium verticillioides*, *F. roliferatum* and *F. subglutinans*. *Eur J Plant Pathol* 110:495–502
- Nganje WA, Bangsund DA, Leistritz FL, Wilson WW, Tiapo NM (2004) Regional economic impacts of *Fusarium* head blight in wheat and barley. *Rev Agr Econ* 26(3):332–337
- Nicholson P, Simpson DR, Weston G, Rezanoor HN, Lees AK, Parry DW, Joyce D (1998) *Phys Mol Plant Pathol* 53:17–37
- Nicholson P, Simpson DR, Wilson AH, Chandler E, Thomsett A (2004) Detection and differentiation of trichothecene and enniatin-producing *Fusarium* species on small-grain cereals. *Eur J Plant Pathol* 110:503–514
- Nicolaisen M, Justesen AF, Thrane U, Skouboe P, Holmstrom K (2005) An oligonucleotide microarray for the identification and differentiation of trichothecene-producing and non-producing *Fusarium* species occurring on cereal grain. *J Microbiol Meth* 62:57–69
- Niessen ML, Vogel RF (1998) Group specific PCR-detection of potential trichothecene-producing *Fusarium*-species in pure cultures and cereal samples. *Syst Appl Microbiol* 21(4):618–631
- Proctor RH, Desjardins AE, Plattner RD, Hohn TM (1999) A polyketide synthase gene required for biosynthesis of fumonisin mycotoxins in *Gibberella fujikuroi* mating population A. *Fungal Genet Biol* 27:100–112
- Proctor RH, Brown DW, Plattner RD, Desjardins AE (2003) Co-expression of 15 contiguous genes delineates a fumonisin biosynthetic gene cluster in *Gibberella moniliformis*. *Fungal Genet Biol* 38:237–249

- Reischer GH, Lemmens M, Farnleitner AH, Adler A, Mach RL (2004) Quantification of *Fusarium graminearum* in infected wheat by species specific real-time PCR applying a TaqMan probe. *J Microbiol Meth* 59:141–146
- Robertson-Hoyt LA, Jines MP, Balint-Kurti PJ, Kleinschmidt CE, White DE, Payne GA, Maragos CM, Molnár TL, Holland JB (2006) QTL mapping for *Fusarium* Ear rot and Fumonisin contamination resistance in two maize populations. *Crop Sci* 46:1734–1743
- Petcu G, Ioniã S (1998) Influence of crop rotation on weed infestation and *Fusarium* spp. attack, yield and quality of winter wheat. *Rom Agric Res* 9–10:83–91
- Reid LM, Zhu X, Ma BL (2001) Crop rotation and nitrogen effects on maize susceptibility to Gibberella (*Fusarium graminearum*) ear rot. *Plant Soil* 237(1):1–14
- Schnerr H, Niessen L, Vogel RF (2001) Real-time detection of the *tri5* gene in *Fusarium* by LightCycler-PCR using SYBR Green I for continuous fluorescence monitoring. *Int J Food Microbiol* 71:53–61
- Schnerr H, Vogel RF, Niessen L (2002) Correlation between DNA of trichothecene-producing *Fusarium* species and deoxynivalenol concentrations in wheat samples. *Letters Appl Microbiol* 35:121–125
- Steinkellner S, Langer I (2004) Impact of tillage on the incidence of *Fusarium* spp. in soil. *Plant Soil* 267(1–2):13–22
- Strausbaugh CA, Overturf K, Koehn AC (2005) Pathogenicity and real-time PCR detection of *Fusarium* spp. in wheat and barley roots. *Can J Plant Pathol* 27:430–438
- Waalwijk C, de Kastelein P, Fries PM, Kerényi Z, van der Lee TAJ, Hesselink T, Köhl J, Kema GHJ (2003) Major changes in *Fusarium* spp. in wheat in the Netherlands. *Eur J Plant Pathol* 109:743–754
- Waalwijk C, van der Heide R, de Vries I, van der Lee T, Schoen C, Corainville GC, Häusler-Hahn I, Kastelein P, Köhl J, Lonnet P, Demarquet T, Kema GHJ (2004) Quantitative detection of *Fusarium* in wheat using TaqMan. *Eur J Plant Pathol* 110:481–494
- Waalwijk C, Koch SH, Ncube E, Allwood J, Flett B, de Vries I, Kema GHJ (2008) Quantitative detection of *Fusarium* spp and its correlation with fumonisin content in maize from South African subsistence farmers. *World Mycotox J* 1(1):39–47
- Weiland JJ, Sundsbak JL (2000) Differentiation and detection of sugar beet fungal pathogens using PCR amplification of actin coding sequences and the ITS region of the rRNA gene. *Plant Dis* 84(4):475–482
- Windels CE (2000) Economic and social impacts of *Fusarium* head blight: changing farms and rural communities in the Northern Great Plains. *Phytopathology* 90(1):17–21
- Yli-Mattila T, Mach RL, Alekhina IA, Bulat SA, Koskinen S, Kullnig-Gradinger CM, Kubicek CP, Klemsdal SS (2004a) Phylogenetic relationship of *Fusarium langsethiae* to *Fusarium poae* and *Fusarium sporotrichioides* as inferred by IGS, ITS,  $\beta$ -tubulin sequences and UP-PCR analysis. *Int J Food Microbiol* 95:267–285
- Yli-Mattila T, Paavanen-Huhtala S, Konstantinova P, Gagkaeva TY (2004b) Molecular and morphological diversity of *Fusarium* species in Finland and north-western Russia. *Eur J Plant Pathol* 110:573–585
- Yli-Mattila T, Paavanen-Huhtala S, Jestoi M, Parikka P, Hietaniemi V, Gagkaeva T, Sarlin T, Haikara A, Laaksonen S, Rizzo A (2008) Real-time PCR detection and quantification of *Fusarium poae*, *F. graminearum*, *F. sporotrichioides* and *F. langsethiae* in cereal grains in Finland and Russia. *Arch Phytopathol Plant Prot* 41(4):243–260
- Youssef SA, Maymon M, Zveibil A, Klein-Gueta D, Szejnberg A, Shalaby AA, Freeman S (2007) Epidemiological aspects of mango malformation disease caused by *Fusarium mangiferae* and source of infection in seedlings cultivated in orchards in Egypt. *Plant Pathol* 56:257–263

# Chapter 6

## DNA-Based Tools for the Detection of *Fusarium* spp. Pathogenic on Maize

Ivan Visentin, Danila Valentino, Francesca Cardinale, and Giacomo Tamietti

**Abstract** Pink and red ear rot of maize are common diseases in temperate cropping zones. These diseases are caused by toxigenic fungi belonging to the genus *Fusarium*. Economic losses flow from both reduced yield (shriveled grain) and compromised quality (contamination with mycotoxin). Since the etiology of these diseases is complex and the taxonomy of the genus *Fusarium* is fluid, there has been a rapid evolution of PCR-based assays for the detection and quantification of toxigenic *Fusarium* spp. in biological material, and for their assignment to the correct phylogenetic species. Following a brief overview of the symptoms and epidemiology of ear rots in maize, we discuss the toxigenicity of the causal agents and their taxonomy, and finally survey the range of DNA-based tools available for the detection, identification, and quantification of *Fusarium* spp. pathogenic on maize.

### 6.1 Introduction

Maize, like most cereals, can be infected by a range of pathogens, some of which can significantly damage the economic value of the crop. *Fusarium* spp. infection of maize has been of particular concern in recent years, because several of these pathogens produce toxic metabolites (mycotoxins) which represent significant contaminants of food and feed (Marasas et al. 1984). Although only a few mycotoxins are considered to represent a realistic threat to human or animal health, some, especially the trichothecenes, zearalenone, and fumonisins, are very stable during seed storage and food/feed processing (Widestrand and Pettersson 2001). Despite extensive toxicological studies, their significance to human health remains unclear, and even less understood is the risk of synergistic interactions when two or more

---

I. Visentin, D. Valentino, F. Cardinale, and G. Tamietti  
DiVaPRA – Plant Pathology, University of Turin, I-10095 Grugliasco, Turin, Italy  
e-mail: giacomo.tamietti@unito.it

toxins occur together in food or feed. With the decreased use of fungicides resulting from the move to lower input cropping technologies and organic farming, there is particular need to monitor the presence of these mycotoxins in cereals and cereal products.

The (molecular) diagnosis of plant pathogens requires a detailed knowledge of disease etiology and the taxonomy of the causal agents, and these are complex issues for the maize/*Fusarium* spp. interaction. Therefore, following a short survey of the biochemistry, toxicity, and mechanisms of action of the major *Fusarium* toxins which can accumulate in maize, this chapter aims to outline the epidemiology of the common *Fusarium* diseases of temperate maize, and the main taxonomic issues surrounding the *Fusarium* genus. The focus, however, is on what DNA-based tools are available to quickly and reliably classify *Fusarium* isolated from maize, and to diagnose and quantify toxigenic strains from field samples.

## 6.2 Major *Fusarium* Toxins in Maize

### 6.2.1 *Fumonisin*s

The fumonisins are a group of food-borne carcinogenic mycotoxins produced by *F. verticillioides* (Saccardo) Nirenberg, *F. proliferatum* (Matsushima) Nirenberg, and *F. nygamai* Burgess & Trimboli. They can be fatal to horses, causing extensive necrosis of brain tissue (equine encephalomalacia), to pigs by chronic accumulation of fluid in the lungs (porcine pulmonary oedema), and to rats by necrosis of the liver. They are suspected to be the etiological agent of oesophageal carcinoma in humans (Marasas et al. 1988). Wild type strains of *F. verticillioides* produce almost exclusively four B-series fumonisins, molecules consisting of two tricarballic esters attached to a carbon backbone (Bezuidenhout et al. 1988; Nelson et al. 1993). Esterification is an essential step in the maturation of the fumonisins, without which the molecule does not display full biological activity (Seefelder et al. 2003). The most common fumonisin present in naturally contaminated maize is B1 (FB1, Fig. 6.1), a molecule with an aminoicosapentol backbone with two hydroxyl groups esterified with 3-carboxy-1,5-pentanedioic acid. Less oxygenated fumonisins, which occur at levels considerably lower than FB1, are FB2 (lacking the C-10 hydroxyl group), FB3 (lacking the C-5 hydroxyl group), and FB4 (lacking both

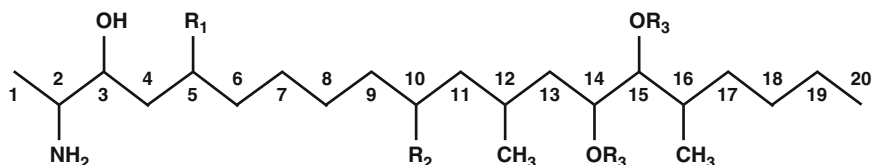


Fig. 6.1 Structure of the B-series fumonisins

groups) (Powell and Plattner 1995). The backbone is formed from the reaction between a C18 polyketide chain and one amino acid. Isotope feeding experiments have shown that C3–C20 of the backbone are derived from acetate, and that the amino group and C-1 and C-2 are derived from alanine (Blackwell et al. 1996; Branham and Plattner 1993).

The effect of fumonisin on the plant host is not well understood. Some inhibitory effects of FB1 on the growth of maize callus cells have been reported (Van Asch et al. 1992), and both the induction of foliar symptoms on sweet corn hybrids and the inhibition of H<sup>+</sup>-ATPase activity have been documented (Glenn et al. 2008, Gutierrez-Najera et al. 2005). FB1 can induce cell death in a fashion reminiscent of the hypersensitive response also in *Arabidopsis thaliana*, as a result of which FB1 has been used by some researchers to study defence-related cell death signalling events in this model plant (Asai et al. 2000). It has been suggested that FB1 acts differently in *A. thaliana* than in other plant species (Chivasa et al. 2005). However, the wide range of genetic, genomic, and physiological tools developed in *A. thaliana* has ensured that much of the exploration of the activity of the fumonisins on the plant host has been carried out in this model plant.

A natural primary hypothesis is that the toxicity of fumonisin to plant cells is, as it is for animal cells, associated with the inhibition of ceramide synthase. The structural similarity of FB1 to sphingosin has been established as being the basis for its disruption of sphingolipid metabolism, thereby perturbing various membrane functions and leading to cell death (Abbas et al. 1994; Riley et al. 1996; Williams et al. 2006). An alternative, but nonexclusive hypothesis is that FB1 perturbs plasma membrane functionality by interfering with the activity of H<sup>+</sup>-ATPase, which is the target for several fungal toxins and elicitors (Marra et al. 1996; Wevelsiep et al. 1993). Gutiérrez-Najera and coworkers identified FB1 as a potent inhibitor of plasma membrane H<sup>+</sup>-ATPase in the maize embryo. FB1 has high affinity for this enzyme, and inhibition is uncompetitive (Gutierrez-Najera et al. 2005). Uncompetitive inhibition is the most effective form of inhibition, but is rather rare in nature, possibly because of the risk it poses for metabolism (Cornish-Bowden 1986). A twofold toxicity mechanism has therefore been proposed for FB1 and its homologues: one is indirect, and acts by raising the level of endogenous sphingoid compounds present through their action on sphinganine N-acyltransferase; the second is direct, acting by uncompetitive inhibition of H<sup>+</sup>-ATPase.

## 6.2.2 *Trichothecenes*

The trichothecenes are a group of epoxysesquiterpene molecules which can be conveniently classified, on the basis of their chemical structure, into three types: type A, of which T-2 is an example, type B (such as deoxynivalenol – DON), and the macrocyclic trichothecenes, which are not produced by *Fusarium* spp. (Fig. 6.2 and not shown). The trichothecenes inhibit eukaryotic translation (McLaughlin et al. 1977), and act as virulence factors in the wheat/*Fusarium* interaction

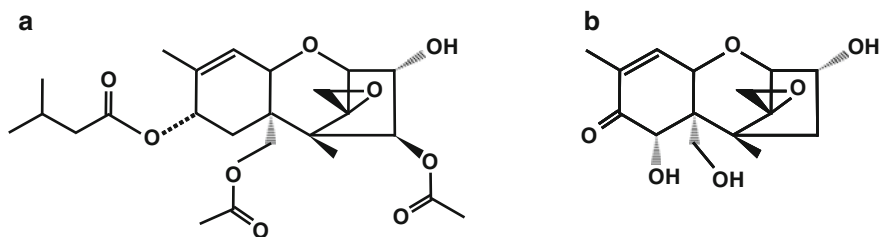


Fig. 6.2 Structure of T-2 toxin (a) and DON (b)

(Bai et al. 2002; Proctor et al. 1995). T-2 (Fig. 6.2a), which is one of the most acutely poisonous of the *Fusarium* toxins, is produced by *F. acuminatum* Ell. Kellerm, *F. equiseti* (Corda) Sacc, and *F. sporotrichioides* Scherb. T-2 toxin-treated *A. thaliana* seedlings are stunted and aberrant in their morphology, and microarray analysis in *A. thaliana* has suggested that the toxin induces a number of defence-related responses, inactivates brassinosteroid synthesis, and generates reactive oxygen species (Masuda et al. 2007). DON (Fig. 6.2b), which is much more common in wheat, barley, oat, rice and maize than T-2, is produced primarily by *F. graminearum* Schwabe (telomorph *Gibberella zeae* [Schw.] Petch) and *F. culmorum* Sacc., the causal agents, respectively, of red ear rot in maize and head blight in wheat. DON is also known as vomitoxin because of its emetic effect. The level of DON contamination in cereals varies from harvest to harvest, and is directly correlated with the presence of *F. graminearum* and *F. culmorum*. DON appears to inhibit translation in *A. thaliana* cells, but unlike T-2, this activity is not associated with the induction of a defence response (Masuda et al. 2007).

### 6.3 Epidemiology and Etiology of Maize Pink and Red Ear Rot

*Fusarium* spp. that generate pink or red ear rot are classified as belonging to the *Liseola* and *Discolor* section, respectively. The former disease is more frequent in hot dry climates, typical of the temperate production zones; the latter predominates in cooler, moister climates (Bottalico 1998; Logrieco et al. 1995). Although the importance of *Fusarium* diseases of maize has been understood for many years, high levels of genetic resistance have yet to be introduced into commercial hybrids, even though several dominant genes determining resistance to fumonisin-producing *Fusarium* spp. have been identified in various inbred lines (Clements et al. 2004).

#### 6.3.1 Pink Ear Rot

This disease occurs on isolated kernels, groups of kernels, or damaged kernels, and is recognized by the formation of a white to light pink mold (Miller 1994). Maize is

typically grown as either a continuous monoculture or in short rotations with one or two other crops. As a result, most fields retain maize debris in or on the soil, or in neighboring fields. Such plant residue is the primary source of inoculum (Smith and White 1988), as *Fusarium* spp. survive well on maize residue, either as mycelium or other survival structures (Sutton 1982). In particular, *F. verticillioides* can produce thickened surviving hyphae (Nyval and Kommdahl 1968), or colonize senescent tissues of other crops and weeds not considered as true hosts (Parry 1995). These heterothallic *Fusarium* species sporadically produce perithecia, but sexual reproduction is unlikely to play a significant role in their epidemiology. *F. verticillioides*, *F. proliferatum*, and *F. subglutinans* produce large quantities of micro- and macroconidia on crop residues, which act as the most important source of inoculum (Smith and White 1988). Microconidia are typically the more numerous and more easily wind-dispersed than macroconidia. Insects can also play a significant role in inoculum dispersion (Dowd 1998; Gilbertson et al. 1986); in Europe, *Ostrinia nubilalis* (the corn borer) is the most effective of such vectors, its larvae acquiring the spores from leaf surfaces and transporting them into the kernels (Sobek and Munkvold 1999). Silk infection is also important in the development of symptomless colonization and pink ear rot, especially where insect damage is limited (Desjardins et al. 2002; Munkvold and Desjardins 1997; Nelson et al. 1992). The influence of systemic infection from seed-borne inoculum on the development of pink ear rot is disputed. *F. verticillioides* can systemically and asymptotically colonize maize from the infected seed or the root, resulting in invasion of the kernels (Foley 1962; Munkvold et al. 1997). Although there may be certain environmental conditions which favor systemic transmission, kernel infection via this route appears to be only of minor importance under standard field conditions (Desjardins et al. 1998; Munkvold and Carlton 1997). A combination of host genetic resistance (Clements et al. 2004), pathogen variability (Carter et al. 2002; Melcion et al. 1997), and drought stress (the latter being a common event during the grain-filling period in temperate production areas) interacts to modulate the severity of the disease infection and the accumulation of mycotoxin. Several lines of evidence indicate that drought stress is associated with elevated levels of *F. verticillioides* infection and fumonisin accumulation in kernels (Marin et al. 2001).

### 6.3.2 Red Ear Rot

Red ear rot of maize is caused by one or more of *F. graminearum*, *F. culmorum*, *F. equiseti*, *F. chlamyosporum* Wollenw. & Reinking, *F. acuminatum*, *F. semitectum* Berk. & Rav., and less frequently by *F. heterosporum* Nees, *F. sporotrichioides*, *F. avenaceum* (Corda ex Fries) Sacc. (telomorph *Gibberella avenacea* Cook), and *F. poae* (Peck) Wollenw. All these fungi can heavily colonize either the stalk, resulting in premature plant death, and/or the bract, silk, and grain, resulting in the cob, starting from its tip, becoming covered in a pink or red mold (Abbas et al. 1988; Bottalico et al. 1989; Munkvold 2003a). On small grain cereals,

infection is associated with reduced seed germination, seedling death, and head blight (Garcia Júnior et al. 2007; Matusinsky et al. 2008; Osborne and Stein 2007; Xu et al. 2008). During the colonization process, a range of mycotoxins is produced, including zearalenone, zearalenol, DON, 3-acetyl DON, 15-acetyl DON, and T-2, all of which accumulate in kernels and serve to enhance disease development (Desjardins et al. 1993, Ohsato et al. 2007; Rocha et al. 2005; Wang et al. 2006). The epidemiology of the diseases incited by the fungi responsible for maize red ear rot has been widely investigated in the small grain crops, but much of the derived knowledge can be readily transferred to maize.

The causal agents survive in the seed in plant debris colonized when senescent or dead, in alternative hosts (other crops or weeds) and as chlamydozoospores on plant debris, and in the soil (Munkvold 2003a; Parry 1995). Debris from potato, sugar beet, and soybean crops have been identified as the source of inoculum for wheat head blight (Broders et al. 2007; Burlakoti et al. 2007). Seed infection is very common and efficient for these *Fusarium* spp., and allows a ready dispersal of strains (Gilbert et al. 2005; Guo et al. 2008; Shah et al. 2005). Perithecia and/or conidia are produced from colonized plant debris. *Gibberella zeae* perithecia differentiate when the temperature falls in the range 16–29°C and the substrate moisture level lies between –0.45 and –1.30 MPa (Dufault et al. 2006; Munkvold 2003a). At lower temperatures, or when precipitation exceeds 5 mm, ascospores are ejected from dehydrated perithecia, and are wind-dispersed over long distances (Broders et al. 2007; Osborne and Stein 2007; Trail et al. 2005). The aerial concentration of ascospores begins to rise between 3 and 5 pm, when relative humidity is at its lowest, and peaks at 9 pm. Compared with the population of ascospores, only small numbers of macroconidia are produced from sporodochia on colonized residues (Inch et al. 2005). The temperature optimum for this process is about 29°C and their dispersal mechanism is similar to that of ascospores (Bergstrom and Shields 2002; Tschanz et al. 1976). Within the temperature range 4–30°C and at 100% relative humidity, 50% of ascospores germinate within 33 h. Germination also succeeds at relative humidity levels as low as 53%, but the percentage of germination decreases with the relative humidity (Beyer and Verreet 2005).

Host plants are most susceptible to infection at, and shortly after anthesis (Osborne and Stein 2007), but wheat can be infected up until the hard dough stage. Late infections are associated with significant accumulations of DON but not with a loss in grain weight (Ponte et al. 2007). The critical time for *F. graminearum* infection of the small grain cereals depends on the flowering habit. Thus, barley cultivars with a gaping flower become susceptible just after anthesis, but closed flowering types are only attacked 10 days after anthesis, and this has a significant influence on the amount of mycotoxin accumulated in the grain (Yoshida et al. 2007). A detailed description of the infection process of maize grains via the silk has been given by Miller and co-workers (Miller et al. 2007). Briefly, after germination, the hyphae penetrate the silk and grow towards the cob, ultimately infecting the developing kernels directly through the silk attachment point or indirectly through the ovary wall. Cobs can also be colonized directly via the seed pedicel or glumes. Rainy and humid conditions are particularly conducive



for disease development, and air temperature has a selective effect on the identity of the pathogen – thus *F. graminearum* predominates in warm areas and *F. culmorum* in temperate or cooler ones (Munkvold 2003b, Osborne and Stein 2007). In a survey of wheat and maize grain infected by *Fusarium* spp. in NW Italy, a low incidence of wheat head blight (1.2–1.4%), and negligible red ear rot and grain mycotoxin contamination in maize were observed over the years 2005–2007, which were characterized by hot, dry weather. However, wheat head blight was extremely common in 2008 (96% for zero tillage crops, and 45% for cultivated ones), a year in which heavy rain and cool conditions prevailed during May and June. Data on maize ear rot for 2008 in the same area are not available yet (G. Tamietti et al, unpublished data). The dependence on cultivation practice underlines the role of crop residues as a source of inoculum (Schaafsma et al. 2005) although the effect can be attenuated where prevailing winds promote long-distance inoculum dispersal (Osborne and Stein 2007). *G. zeae* ascospores were abundant in the planetary boundary layer throughout crop seasons independent of the time of day, but highly dependent on the extent of cloudiness (Maldonado-Ramirez et al. 2005). Instead, no significant effect of soil management on the incidence of *Fusaria* as stem-base pathogens in winter wheat was noted (Matusinsky et al. 2008). In wheat, grain colonization by *F. graminearum* occurs when the temperature is in the range 15–30°C and when water activity (aW) is between 0.900 and 0.995, whereas DON production occurs in the narrower aW range of 0.95–0.995 (Ramirez et al. 2006). Thus cereal varieties able to dry quickly at maturity are probably less prone to DON contamination.

#### 6.4 General Species Concepts and Species Borders Within the Genus *Fusarium*

Mayden considered species concepts as being either theoretical or operational, with the latter being the most relevant in the context of diagnosis (Mayden 1997). All the three common operational species concepts – morphological, biological, and phylogenetic (respectively, MSC, BSC and PSC) – aim to recognize evolutionary distinct species. The theoretical Evolutionary Species Concept (ESC) defines a species as being “.. a single lineage of ancestor-descendent populations which maintains its identity from other such lineages and which has its own evolutionary tendencies and historical fate” (Wiley 1978). The ESC is not informative for species identification, as it is not associated with particular recognition criteria. In contrast, MSC, BSC, and PSC do specify such criteria, but none of the methods of species recognition derived from morphological, biological, and phylogenetic species recognition (respectively, MSR, BSR and PSR) are able to recognize the point at which an ancestral species split into distinct derived species, because changes in morphology, mating behavior, or gene sequences require the passage of time. Under ESC, species are recognized by MSR, BSR, or PSR, but several

examples are available of fungal species in which the borders defined in this way do not fully coincide, and this complicates the elaboration of an unequivocal evolutionary pedigree for this kingdom (Taylor et al. 2000). Phylogenetic analyzes based on variable DNA sequences are thought to be more effective in recognizing species consistent with ESC. PSR performs well because evolutionary changes in gene sequence can be recognized long before any changes in mating behavior or morphology (Taylor et al. 2000). Allelic variation at the DNA sequence level does, however, present a problem for PSR, as it can lead to the artefactual splitting of two con-specific isolates into two distinct species; this is a drawback especially in the case of a fungal species lacking a teleomorph (so BSR cannot be applied). This problem is best overcome by consideration of multiple gene genealogies (genealogical concordance phylogenetic species recognition) (Taylor et al. 2000).

The content of the genus *Fusarium*, created by Link (1809), has been variously modified. The first round of reclassifications organized the genus into 16 sections including 65 species, 55 varieties, and 22 forms (Toussoun and Nelson 1975; Wollenweber and Reinking 1935). The main discriminating criteria between sections were morphological, in particular the presence and shape of microconidia, the presence and position along the hyphae of chlamyospores, and the shape of macroconidia and basal cells. All species, varieties, and forms within a section were further characterized by the color of the stroma, the presence of sclerotia, and the number and dimensions of the macroconidial septa. This approach also relied on the observation of fungal growth on different and specific culture media. In 1983, a simpler classification method was proposed, in which the genus was divided into 12 sections and 30 species, and current taxonomic treatments are based on this concept (Burgess et al. 1994; Nelson et al. 1983). In this chapter only the *Discolor* and *Liseola* sections are considered, as all the major maize pathogens belong to one or other of these two groups.

### 6.4.1 Section *Liseola*

This section includes the fumonisin-producing maize pathogens, and comprises the four morphological species *F. moniliforme*, *F. proliferatum*, *F. subglutinans*, and *F. anthropilum* according to Nelson et al. (1983). Later this was extended to six (*F. anthropilum*, *F. fujikuroi*, *F. proliferatum*, *F. sacchari*, *F. succisae*, and *F. verticillioides*) by Nirenberg (Nirenberg 1989). *G. fujikuroi* (Sawada) Ito in Ito e K. Kimura is the teleomorph of several *Fusarium* species within Section *Liseola*, in which Hsieh et al. identified the three Mating Populations (MP) A, B, C (Hsieh et al. 1977). Subsequently, Kuhlman identified a fourth species and introduced the terminology MP-A (*G. fujikuroi* var. *moniliformis*), MP-B (*G. fujikuroi* var. *subglutinans*), MP-C (*G. fujikuroi* var. *fujikuroi*), and MP-D (*G. fujikuroi* var. *intermedia*) (Kuhlman 1989). Since this time, further MPs have been uncovered: MP-E through MP-K (Geiser et al. 2005; Klaasen and Nelson 1996; Lepoint et al. 2005; Leslie 1991; Nirenberg and O'Donnell 1998; Phan et al. 2004; Zeller et al. 2003).

**Table 6.1** Biological species (MP) in the *Liseola* section of the *G. fujikuroi* species complex (modified from (Leslie and Summerell 2006))

MP	Anamorph	Teleomorph
MP-A	<i>Fusarium verticillioides</i>	<i>Gibberella moniliformis</i>
MP-B	<i>F. sacchari</i>	<i>G. sacchari</i>
MP-C	<i>F. fujikuroi</i>	<i>G. fujikuroi</i>
MP-D	<i>F. proliferatum</i>	<i>G. intermedia</i>
MP-E	<i>F. subglutinans</i>	<i>G. subglutinans</i>
MP-F	<i>F. thapsinum</i>	<i>G. thapsina</i>
MP-G	<i>F. nygamai</i>	<i>G. nygamai</i>
MP-H	<i>F. circinatum</i>	<i>G. circinata</i>
MP-I	<i>F. kunzum</i>	<i>G. konza</i>
MP-J	<i>F. gaditjirrii</i>	<i>G. gaditjirrii</i>
MP-K	<i>F. xylarioides</i>	<i>G. xylarioides</i>

In the meanwhile, the outcomes of sexual crosses have been gradually integrated with morphological observations and DNA sequence data. The *G. fujikuroi* species complex in particular has been subjected to various DNA-based phylogenetic analyzes (see later section) (O'Donnell et al. 2000). Overall, the biological, morphological, phylogenetic approaches have produced largely congruent results, and produced the current definition of 11 species (Table 6.1).

As alluded to above, current classifications have been largely founded upon and refined by DNA sequence information, which does not rely on observations of the morphology or sexual fertility of any given isolate. In the *G. fujikuroi* complex, a number of DNA-based approaches has been deployed for this purpose, including electrophoretic karyotyping, RAPD fingerprinting, RFLP genotyping, and DNA sequence comparisons (Steenkamp et al. 1999, 2001; Voigt et al. 1995; Waalwijk et al. 1996; Xu et al. 1995). Thus for example, Xu et al.'s electrophoretic karyotyping method was able to distinguish six MPs (A-F). Increasingly, unknown isolates are assigned to a species on the basis of the DNA sequence within the ribosomal DNA, calmodulin,  $\beta$ -tubulin, and EF-1 genes (Appel and Gordon 1996; Mirete et al. 2004; Mulé et al. 2004, Steenkamp et al. 1999, 2001; Waalwijk et al. 1996). The ribosomal gene family is composed of a tandem array of 18S, 5.8S, and 28S genes, separated from one another by the internal transcribed spacer (ITS) and the intergenic spacer (IGS) regions. As the sequence of the coding regions is well conserved, universal primers can relatively easily be designed; in contrast, the ITS and IGS regions are highly variable, and it is this sequence polymorphism which is exploited for the discrimination between taxa.

### 6.4.2 Section *Discolor*

Section *Discolor* comprises 21 species, according to Gerlach and Nirenberg (1982), but only six according to Nelson et al. (Nelson et al. 1994). The species fall into two major clades, one producing type A and the other type B trichothecenes. Here, we consider the maize pathogens *F. graminearum* and *F. culmorum*, which are the main trichothecene B-producing species. While *F. culmorum* has a

rather distinctive morphology (white or yellow mycelium; stout, thick-walled, and curved macroconidia of width 4–7  $\mu\text{m}$  and length 25–50  $\mu\text{m}$ ; abundant chlamydospores occurring singly, in chains, or in clumps), the species borders of *F. graminearum* have moved significantly in recent years. *F. graminearum* has been conventionally recognized by its straight, moderately robust macroconidia produced in almost colorless sporodochia, by the absence of microconidia in the aerial mycelium, and by the production of macroconidia and chlamydospores in vegetative mycelium. One subdivision of the species has been based on differences in the ability to produce perithecia in culture (Burgess et al. 1975, Francis and Burgess 1977). This criterion correlates with different ecological behavior, since strains belonging to group I (which do not produce perithecia in agar culture and occur in arid areas) cause crown rot of wheat, while group II strains, later renamed *F. pseudograminearum*, produce perithecia in culture, are more toxigenic (DON and ZEA), and cause spikelet disease in wheat and cob rot in maize. Later, Miller et al. recognized three chemotypes (able to produce nivalenol, DON, and other acetylated derivatives to different levels) within the broader species concept of *F. graminearum* (Miller et al. 1991). O'Donnell et al. presented a phylogeny of *F. graminearum* based on six genes, which indicated a division into seven lineages (or phylogenetic species) with distinct geographic origins. One of these lineages is the producer of DON and ZEA in North America and northern Europe (O'Donnell et al. 1998). Ward et al. used sequence variation at eight toxin genes from a single cluster to identify a phylogeny which was not congruent with those suggested by other genes; the conclusion drawn was that the acquisition of the toxin genes preceded speciation, and that a distinct genetic mechanism unrelated to recombination had been responsible for the maintenance of chemotypes across the phylogenetic species within the morphospecies *F. graminearum* (Ward et al. 2002).

## **6.5 DNA Sequence-Based Diagnosis of *Fusarium* spp. Pathogenic On Maize: Species Assignment**

The advent of PCR has opened the way to developing simple diagnostic assays based on unique DNA sequence. Here, we review some of the assays which have been developed to discriminate between the *Fusarium* species pathogenic on maize – i.e., the major agents of pink ear rot (*F. proliferatum*, *F. subglutinans* and *F. verticillioides*) and red ear rot (*F. graminearum* and *F. culmorum*).

### **6.5.1 Species-Diagnostic Primers for the Causal Agents of Pink Ear Rot**

The first published PCR primers diagnostic for *F. moniliforme* (i.e., *F. verticillioides sensu* Nirenberg 1976) were designed from the sequence of a heat shock

protein gene, within which a RAPD polymorphism had been identified (Murillo et al. 1998). The Fus1-2 primer pair detected the presence of *F. verticillioides* DNA in infected plants and soils. Möller et al. developed primers, specific for both *F. verticillioides* (53-6F/R) and *F. subglutinans* (61-2F/R), based on sequences of RAPD fragments, and were able to employ these for the analysis of infected maize kernels (Möller et al. 1999). When the specificity of these primer pairs was tested against a range of other *Fusarium* spp. and a selection of other fungal species, 53-6F/R specifically amplified from template of *G. fujikuroi* MP-A, and 61-2F/R from MP-E. Template of *F. culmorum*, *F. graminearum*, or *F. proliferatum* amplified weakly and only at low annealing temperatures, and the amplicon size was not as expected. Subsequently, Patiño et al. developed the *F. verticillioides*-specific PCR primer pair VERT1/2, based on the sequence of the ribosomal IGS (Patiño et al. 2004). When tested against a panel of 54 *F. verticillioides* strains obtained from a range of geographical origins and hosts, the assay proved unable to discriminate *F. verticillioides* from *F. proliferatum* isolates from Northern Italy (Visentin et al. 2009). A further set of primer pairs were designed by Mulé et al. from the sequence of the taxonomically informative calmodulin gene; these were specific to *F. verticillioides* (VER1/2), *F. subglutinans* (SUB1/2), and *F. proliferatum* (PRO1/2), and their discriminating ability was confirmed in an analysis of 150 maize isolates, mostly from Europe and USA (Mulé et al. 2004). A *F. proliferatum*-specific primer pair (Fp3F/4R) has also been designed, based on the IGS sequence (Jurado et al. 2006). This assay was successfully validated by testing a range of *Fusarium* species, commonly associated with cereals, as well as on other fungal genera and plant material. As for the VERT1/2 assay, *F. proliferatum* could not be always discriminated from isolates of *F. verticillioides* from Northern Italy (Visentin et al. 2009). Very recently, the previously designed forward primer VERT1 (Patiño et al. 2004) was used along with a newly developed reverse primer VERT-R based on the intergenic spacer region (IGS) to detect *F. verticillioides* (Sreenivasa et al. 2008). Finally, a new pair of primers designed on the ITS region and to be used in combination with the ITS1 and ITS4 fungal universal primers was described. Although the ITS region offers no full resolution of the genus *Gibberella*, it may be very useful for the very practical and tedious task of distinguishing unambiguously these two very similar species (Visentin et al. 2009, White et al. 1990). A full list of the *Fusarium*-specific primers described here is given in Table 6.2.

### 6.5.2 Species-Diagnostic Primers for the Causal Agents of Red Ear Rot

Several diagnostic PCR assays have been developed for the causal agents of red ear rot, in particular *F. graminearum* and *F. culmorum*. The first of these to be published involved the two primer pairs UBC85F/R and OPT18F/R, extracted from informative RAPD profiles (Schilling et al. 1996). Both were tested against

**Table 6.2** Specific PCR assays for *F. proliferatum*, *F. subglutinans* and *F. verticillioides*

Primer pairs	Primer sequences	Specificity	Reference
Fus1	5'-cttggctatgggccagtgcaagac-3'	<i>F. moniliforme</i>	Murillo et al. (1998)
Fus2	5'-cacagtcacatagcattgctagcc-3'		
53-6F	5'-tttacgaggcggcgatgggt-3'	<i>F. verticillioides</i>	Möller et al. (1999)
53-6R	5'-ggccggtttacctggcttctt-3'		
61-2F	5'-ggccactcaagaggcgaaag-3'	<i>F. subglutinans</i>	Möller et al. (1999)
61-2R	5'-gtcagaccagagcaatgggc-3'		
VERT1	5'-gtcagaatccatgccagaacg-3'	<i>F. verticillioides</i>	Patiño et al. (2004)
VERT2	5'-caccgcgacaatccatcag-3'		
VER1	5'-cttcctcgcgatggttctcc-3'	<i>F. verticillioides</i>	Mulé et al. (2004)
VER2	5'-aattggccattggtattatatatcta-3'		
PRO1	5'-ctttccgccaagtctctc-3'	<i>F. proliferatum</i>	Mulé et al. (2004)
PRO2	5'-tgtcagtaactcgacgtgttg-3'		
SUB1	5'-ctctgcgtaacctttatcca-3'	<i>F. subglutinans</i>	Mulé et al. (2004)
SUB2	5'-cagtaggacgttggtattatatctaa-3'		
Fp3F	5'-cggccaccagaggatgtg-3'	<i>F. proliferatum</i>	Jurado et al. (2006)
Fp4R	5'-caacacgaatcgcttctctgac-3'		
VERT1	5'-gtcagaatccatgccagaacg-3'	<i>F. verticillioides</i>	Patiño et al. (2004)
VERT-R	5'-cgactcagggccaggaaac-3'		Sreenivasa et al. (2008)
verITS-F	5'-aaatcgcgttccccaaattga-3'	<i>F. verticillioides</i>	White et al. (1990)
ITS4	5'-tcctccgcttattgatatgc-3'		Visentin et al. (2009)
ITS1	5'-tccgtaggtgaacctcgg-3'	<i>F. proliferatum</i>	White et al. (1990)
proITS-R	5'-gcttccgcaaggctcgc-3'		Visentin et al. (2009)

a substantial collection of *Fusarium* spp. and other fungal pathogens associated with red ear rot. The UBC85F/R primers selectively amplified DNA of all the *F. graminearum* strains tested, but in some cases, also weakly amplified a fragment from a template of *F. culmorum*. The OPT18F/R pair amplified as expected from template of 65 out of 69 isolates of *F. culmorum* obtained from various countries and continents. Using a similar approach (Nicholson et al., 1998) generated the four primer pairs Fc01F/R (specific for *F. culmorum*), Fg16F/R and Fg16NF/R (*F. graminearum*), and Fcg17F/R (both *F. culmorum* and *F. graminearum*). Fg16F/R amplified selectively from 19 out of 19 isolates of *F. graminearum*, generating a polymorphic amplicon. A 400 bp product was amplified from the majority of isolates, but three isolates amplified a 470 bp product, one a 500 bp product, and one a 360 bp product. Fg16NF/R generated a monomorphic 280 bp amplicon from all the *F. graminearum* isolates, and the assay was completely specific. Fc01F/R generated a 570 bp amplicon from 21 out of 21 isolates of *F. culmorum*, and did not amplify from a template of *F. graminearum*. Fcg17F/R amplified a 340 bp fragment from all strains of *F. graminearum* and *F. culmorum*. Jurado et al. developed an assay for *F. graminearum* and *F. culmorum* based on the IGS sequence, and tested it on a diverse set of *Fusarium* spp. strains commonly associated with cereals (Jurado et al. 2005). The *F. culmorum*-specific primer pair (Fcu-F/R) amplified a ~ 200 bp fragment from all *F. culmorum* samples, while the *F. graminearum*-specific Fgr-F/R generated a ~ 500 bp amplicon from all but one of the *F. graminearum* strains tested. A full list of the red ear rot specific assays described here is given in Table 6.3.

**Table 6.3** Specific PCR assays for *F. graminearum* and *F. culmorum*

Primer pairs	Primer sequences	Specificity	References
UBC85F	5'-gcagggtttgaatccgagac-3'	<i>F. graminearum</i>	Schilling et al. (1996)
UBC85R	5'-agaatggagctaccaacggc-3'		
OPT18F	5'-gatgccagaccaagacgaag-3'	<i>F. culmorum</i>	Schilling et al. (1996)
OPT18R	5'-gatgccagacgactaagat-3'		
Fc01F	5'-atgtggaactctcgtgtgc-3'	<i>F. culmorum</i>	Nicholson et al. (1998)
FC01R	5'-cccttcttacgccaatctcg-3'		
Fg16F	5'-ctccggatattgttcgctcaa-3'	<i>F. graminearum</i>	Nicholson et al. (1998)
Fg16R	5'-ggtaggtatccgacatggcaa-3'		
Fcg17F	5'-tcgatataccgtcgcatttcc-3'	<i>F. culmorum</i> ,	Nicholson et al. (1998)
Fcg17R	5'-tacagacaccgtcaggggg-3'	<i>F. graminearum</i>	
Fg16NF	5'-acagatgacaagattcaggcaca-3'	<i>F. graminearum</i>	Nicholson et al. (1998)
Fg16NR	5'-ttc ttt gac atc tgt tea acc ca-3'		
Fcu-F	5'-gactatcattatgcttgcgagag-3'	<i>F. culmorum</i>	Jurado et al. (2005)
Fgc-R	5'-ctctcatataccctccg-3'		
Fgr-F	5'-gttgatgggtaaaagtgtg-3'	<i>F. graminearum</i>	Jurado et al. (2005)
Fgc-R	5'-ctctcatataccctccg-3'		

## 6.6 DNA Sequence-Based Diagnosis of *Fusarium* spp. Pathogenic on Maize: Toxicity

The most problematical *Fusarium* spp. pathogens are those which are toxic. Here, we describe available PCR-based methods for identifying and quantifying isolates producing fumonisin and trichothecene from field samples.

### 6.6.1 Fumonisin-Producing *Fusarium* spp

Sensitive PCR-based methods have been developed to detect the toxic species, and especially to identify nonproducing sub-populations or nontoxic strains within the toxic species. Initially, DNA markers were used in conjunction with phylogenetic methods to distinguish between groups of toxin producers and non-producers. For example, Gonzalez-Jaèn et al. developed an IGS-RFLP assay which could identify a polymorphism associated with toxic strains of *F. verticillioides* (González-Jaén et al. 2004). Other authors have highlighted the presence of intra-specific polymorphism for such assays. The application of AFLP and IGS/EF-1a sequence variation led to the definition of two *F. verticillioides* sub-groups, based on a contrast between efficient producers of fumonisin (collected from maize), and nontoxic strains (from Central and South American banana fruits) (Mirete et al. 2004; Moretti et al. 2004). The same nontoxic population was also exploited by Patiño et al. to generate an IGS-RFLP assay diagnostic for toxicity (Patiño et al. 2006). The non-toxic isolates were crossable in vitro with MP-A testers (corresponding to *G. moniliformis*), but showed only about 50% genetic similarity



with *F. verticillioides* strains isolated from maize, and a different chemotoxic profile and virulence on the two hosts (banana and maize). In this case, it was proposed that host specialization had driven the observed genetic drift, which will probably turn into speciation. Several primer pairs were then developed to discriminate toxigenic from non-toxigenic isolates. One of these – diagnostic for *F. verticillioides* fumonisin-producing strains – was based on sequence of the IGS (Patiño et al. 2004). However, since only nonproducing strains from banana were tested, and all these lack the complete FUM cluster (see below), an assay directed at any of the fumonisin biosynthetic pathway genes would have equally allowed this level of discrimination.

Because of the importance of the fumonisin-producing pathogens, some emphasis has been given to elucidating the biosynthetic and regulatory pathway of mycotoxin production. All the fumonisin biosynthetic (*FUM*) genes characterized to date have been located within a 42.5 kb region of the *F. verticillioides* genome, in the so-called “FUM cluster” (Brown et al. 2007 Proctor et al. 2003). Gene clusters in this context are distinct from gene families, which are also frequently clustered. The former implies physical proximity, co-regulation, and participation in a common metabolic pathway. The latter, in addition, implies related sequence, as individual members are thought to have evolved by localized duplication and that subsequent divergence. The significance of gene clusters in this sense has long been debated. One hypothesis holds that clustering is associated with gene co-regulation, reminiscent of prokaryotic operons and regulons (Zhang et al. 2004). Alternatively, they may represent an extended form of selfish genes, facilitating simultaneous mobilization of a discrete biosynthetic function for horizontal transfer (Walton 2000). The FUM cluster consists of 16 co-regulated genes on chromosome I, now designated *FUM1* (previously named *FUM5*), *FUM2* (previously *FUM9*), *FUM3* (previously *FUM12*), *FUM6-8*, *FUM10-11*, *FUM13-19* (Butchko et al. 2003; Proctor et al. 2003, 2006; Seo et al. 2001), and *FUM21* (Brown et al. 2007). The role of some of these genes has been deduced by deletion analysis and/or heterologous expression. The deletion of either *FUM1*, *FUM6*, or *FUM8* blocks the accumulation of all fumonisins, indicating that all are required for fumonisin production (Proctor et al. 1999; Seo et al. 2001). Their role in fumonisin biosynthesis has been inferred from homology to genes of known function and from the analysis of deletion mutants. Several PCR assays have thus been designed to target some of the genes directly involved in mycotoxin biosynthesis, and these have been used in a quantitative mode to correlate the level of fumonisin with the abundance of particular biosynthetic genes (i.e., of the toxigenic fungal strains). In particular, two assays targeting *FUM1*, which encodes a polyketide synthase, have been applied to a range of *Fusarium* spp. and other fungal genera. In both cases, the expected amplicon was observed only in fumonisin-producing strains (*F. verticillioides* and *F. proliferatum*), but an amplicon of the correct size was also generated from template of the normally non-producing species *F. subglutinans* and *F. thapsinum*. López-Errasquín et al. have also observed a significant correlation between the expression level of *FUM1* and *FUM19* and the production of fumonisin B1 (Lopez-Errasquin et al. 2007). Very recently, an additional qPCR test was developed, that targets a



**Table 6.4** PCR assays for the discrimination of fumonisin-producing *Fusarium* strains

Primer pairs	Primer sequences	References
VERTF1	5'-gcgggaattcaaaagtggcc-3'	Patiño et al. (2004)
VERTF2	5'-gagggcgcgaaacggatcgg-3'	
FUM5F	5'-gtcgagttgtgaccactgcg-3'	Bluhm et al. (2002)
FUM5R	5'-cgtatcgtcagcatgatgtagc-3'	
FUM1for	5'-ccatcacagtgggacacagt-3'	Bluhm et al. (2004)
FUM1rev	5'-cgtatcgtcagcatgatgtagc-3'	
PQF1-F	5'-gagccgagtcagcaaggatt-3'	Lopez-Errasquin et al. (2007)
PQF1-R	5'-agggttcgtgagccaagga-3'	
PQF19-F	5'-atcagcatcggtacgcctatga-3'	Lopez-Errasquin et al. (2007)
PQF19-R	5'-catgtaagttgagggaagccctgt-3'	

conserved sequence on the *FUM1* gene and gives a good correlation between the estimated total genomic DNA from fumonisin-producing *Fusarium* species, and fumonisin content in maize kernels (Waalwijk et al. 2008a, b). A list of the primer pairs diagnostic for fumonisin-producing *Fusarium* spp. reviewed here is given in Table 6.4.

### 6.6.2 *Trichothecene-Producing Fusarium spp*

The trichothecene pathway is well explored, and several trichothecene biosynthetic genes have been characterized (Desjardins et al. 1993). Bluhm et al. targeted the gene *TRI6* to produce two PCR assays diagnostic for trichothecene-producing species. These assays were functional only from template of *F. culmorum*, *F. graminearum*, or *F. sporotrichioides*, all of which are known to be good producers of trichothecenes (Bluhm et al. 2002, 2004). Assays directed at a range of other biosynthetic genes have been designed for the same purpose. One of these targets was *TRI5*, encoding the catalyst of the isomerization and cyclization of farnyl phosphate to trichodiene (Hohn and Beremand 1989), and this assay was able to detect trichothecene-producing *Fusarium* spp. both from *in vitro* cultures and from infected cereal samples (Niessen and Vogel 1998; Niessen et al. 2004). A second assay exploited the trichodiene synthase family member *TOX5*, and this was not only able to detect the presence of *F. graminearum* and *F. culmorum* DNA in cereal samples (Niessen and Vogel 1998), but also its quantitative presence could be correlated with the level of DON (Knoll et al. 2002a, b). Chemotype-specific PCR assays were developed by Ward et al. based on the sequence of the *TRI3* and *TRI2* genes (Ward et al. 2002). Finally, an assay has recently been developed based on *TRI13*, and used to explore the toxigenic potential of several Iranian isolates of *F. graminearum* (Haratian et al. 2008). Several research groups are currently working to establish quantitative PCR methods as a means of correlating the abundance of a toxigenic pathogen in a cereal sample with the amount of trichothecenes present. The necessary primer pairs target either one of the trichothecene biosynthetic genes

**Table 6.5** PCR assays for the discrimination of trichothecene-producing *Fusarium* strains

Primer pairs	Primer sequences	References
Tri6F	5'-ctctttgatcggttgcgtc-3'	Bluhm et al. (2002)
Tri6R	5'-cttgttatccgctatagtgc-3'	
Tri6for	5'-tgattacatggaggccgaatctca-3'	Bluhm et al. (2004)
Tri6rev	5'-ttcgaatgttggtgattcatagtcgtt-3'	
Tox5-1	5'-gctgctcatcactttgctcag-3'	Niessen and Vogel (1998)
Tox5-2	5'-ctgatctggtcacgctcatc-3'	
Tri13F	5'-catcatgagactgtkcrgtttggg-3'	Haratian et al. (2008)
Tri13R	5'-ttgaaagctccaatgctgtg-3'	
TMTrif	5'-cagcagmtrctcaaggtagacc-3'	Halstensen et al. (2006)
TMTrir	5'-aactgtayacraccatgccaac-3'	
Tr5F	5'-agcgactacaggtccctc-3'	Doohan et al. (1999)
Tr5R	5'-aaaccatccagttctccatctg-3'	
FGtubf	5'-ggctcgcagacaatggtgtt-3'	Reischer et al. (2004)
FGtubr	5'-gcttgtgttttcgtggcagt-3'	

(Halstensen et al. 2006; Schnerr et al. 2002) or the gene encoding beta-tubulin (Reischer et al. 2004). The PCR assays specific to trichothecene-producing *Fusarium* spp. reviewed here are listed in Table 6.5.

## 6.7 Conclusion and Future Lines of Research

Species definition can be difficult in the fungi, because morphological variation between sibling species is often lacking or difficult to recognize, and because many species lack a known teleomorph. Phylogenetic analyses are therefore particularly valuable to assign isolates to their correct species. We have discussed here a variety of DNA-based tools which allow for a rapid and reliable diagnosis of *Fusarium* spp. within the *Liseola* and *Discolor* sections, and for the detection and quantification of toxin-producing isolates. PCR-based methods are relatively straightforward and quick, but are not totally error-free. Their precision should increase as the informative loci from more isolates of different provenance are sequenced.

## References

- Abbas HK, Mirocha CJ, Meronuck RA, Pokorny JD, Gould SL, Kommedahl T (1988) Mycotoxins and *Fusarium* spp. associated with infected ears of corn in Minnesota. *Appl Environ Microbiol* 54:1930–1933
- Abbas HK, Tanaka T, Duke SO, Porter JK, Wray EM, Hodges L, Sessions AE, Wang E, Merrill AH Jr, Riley RT (1994) Fumonisin- and AAL-toxin-induced disruption of sphingolipid metabolism with accumulation of free sphingoid bases. *Plant Physiol* 106:1085–1093
- Appel DJ, Gordon TR (1996) Relationships among pathogenic and nonpathogenic isolates of *Fusarium oxysporum* based on the partial sequence of the intergenic spacer region of the ribosomal DNA. *Mol Plant Microbe Interact* 9:125–138

- Asai T, Stone JM, Heard JE, Kovtun Y, Yorgey P, Sheen J, Ausubel FM (2000) Fumonisin B1-induced cell death in arabidopsis protoplasts requires jasmonate-, ethylene-, and salicylate-dependent signaling pathways. *Plant Cell* 12:1823–1836
- Bai GH, Desjardins AE, Plattner RD (2002) Deoxynivalenol-nonproducing *Fusarium graminearum* causes initial infection, but does not cause disease spread in wheat spikes. *Mycopathologia* 153:91–98
- Bergstrom GC, Shields EJ (2002) Atmospheric spore dispersal and regional epidemiology of the *Fusarium* head blight fungus. *Phytopathology* 92:S93
- Beyer M, Verreet JA (2005) Germination of *Gibberella zeae* ascospores as affected by age of spores after discharge and environmental factors. *Eur J Plant Pathol* 111:381–389
- Bezuidehout CS, Genderblom WCA, Gorst-allman CP, Horak RM, Marasas WFO, Spiteller G, Vleggaar R (1988) Structure elucidation of the fumonisins, mycotoxins from *Fusarium moniliforme*. *J Chem Soc Lond Chem Commun* 52:743–745
- Blackwell BA, Edwards OE, Fruchier A, ApSimon JW, Miller JD (1996) NMR structural studies of fumonisin B1 and related compounds from *Fusarium moniliforme*. *Adv Exp Med Biol* 392:75–91
- Bluhm BH, Flaherty JE, Cousin MA, Woloshuk CP (2002) Multiplex polymerase chain reaction assay for the differential detection of trichothecene- and fumonisin-producing species of *Fusarium* in cornmeal. *J Food Prot* 65:1955–1961
- Bluhm BH, Cousin MA, Woloshuk CP (2004) Multiplex real-time PCR detection of fumonisin-producing and trichothecene-producing groups of *Fusarium* species. *J Food Prot* 67:536–543
- Bottalico A, Logrieco A, Visconti A (1989) *Fusarium* species and their mycotoxins in infected corn in Italy. *Mycopathologia* 107:85–92
- Bottalico A (1998) *Fusarium* disease of cereals: species complex and related mycotoxin profiles, in Europe. *Eur J Plant Pathol* 80:85–103
- Branham BE, Plattner RD (1993) Alanine is a precursor in the biosynthesis of fumonisin B1 by *Fusarium moniliforme*. *Mycopathologia* 124:99–104
- Brodgers KD, Lipps PE, Paul PA, Dorrance AE (2007) Evaluation of *Fusarium graminearum* associated with corn and soybean seed and seedling disease in Ohio. *Plant Dis* 91:1155–1160
- Brown DW, Butchko RA, Busman M, Proctor RH (2007) The *Fusarium verticillioides* FUM gene cluster encodes a Zn(II)2Cys6 protein that affects FUM gene expression and fumonisin production. *Eukaryot Cell* 6:1210–1218
- Burgess LW, Wearing AH, Toussoun TA (1975) Surveys of the fusaria associated with crown rot of wheat in eastern Australia. *Aust J Agric Res* 26:791–799
- Burgess LW, Summerell BA, Bullock S, Gott KP, Blackhouse D (1994) *Laboratory Manual for Fusarium Research*, 3rd edn. Department of Crop Sciences, University of Sydney, Sydney
- Burlakoti RR, Estrada RJ, Rivera VV, Boddada A, Secor GA, Adhikari TB (2007) Real-time PCR quantification and mycotoxin production of *Fusarium graminearum* in wheat inoculated with isolates collected from potato, sugar beet, and wheat. *Phytopathology* 97:835–841
- Butchko RA, Plattner RD, Proctor RH (2003) FUM9 is required for C-5 hydroxylation of fumonisins and complements the meiotically defined Fum3 locus in *Gibberella moniliformis*. *Appl Environ Microbiol* 69:6935–6937
- Carter JP, Rezanoor HN, Holden D, Desjardins AE, Plattner RD, Nicholson P (2002) Variation in pathogenicity associated with the genetic diversity of *Fusarium graminearum*. *Eur J Plant Pathol* 108:573–583
- Chivasa S, Ndimba BK, Simon WJ, Lindsey K, Slabas AR (2005) Extracellular ATP functions as an endogenous external metabolite regulating plant cell viability. *Plant Cell* 17:3019–3034
- Clements MJ, Maragos CM, Pataky JK, White DG (2004) Sources of resistance to fumonisin accumulation in grain and *Fusarium* ear and kernel rot of corn. *Phytopathology* 94:251–260
- Cornish-Bowden A (1986) Why is uncompetitive inhibition so rare? a possible explanation, with implications for the design of drugs and pesticides. *FEBS Lett* 203:3–6
- Desjardins AE, Hohn TM, McCormick SP (1993) Trichothecene biosynthesis in *Fusarium* species: chemistry, genetics, and significance. *Microbiol Rev* 57:595–604

- Desjardins AE, Plattner RD, Lu M, Claffin LE (1998) Distribution of fumonisin in maize ears infected with strains of *Fusarium moniliforme* that differ in fumonisin production. *Plant Dis* 82:953–958
- Desjardins AE, Munkvold GP, Plattner RD, Proctor RH (2002) *FUM1* – a gene required for fumonisin biosynthesis but not for maize ear rot and ear infection by *Gibberella moniliformis* in field tests. *Mol Plant Microbe Interact* 15:1157–1164
- Doohan FM, Weston G, Rezanoor HN, Parry DW, Nicholson P (1999) Development and use of a reverse transcription-PCR Assay to study expression of *Tri5* by *Fusarium* Species in vitro and in planta. *Appl Environ Microbiol* 65:3850–3854
- Dowd PF (1998) Involvement of arthropods in the establishment of mycotoxigenic fungi under field conditions. In: Sinha K, Bhatnagar D (eds) *Mycotoxins in agriculture and food safety*. Marcel Dekker, New York, pp 307–350
- Dufault NS, Wolf ED, de Lipps PE, Madden LV (2006) Role of temperature and moisture in the production and maturation of *Gibberella zeae* perithecia. *Plant Dis* 96:637–644
- Foley DC (1962) Systemic infection of corn by *Fusarium moniliforme*. *Phytopathology* 52:870–872
- Francis RG, Burgess LW (1977) Characteristics of two populations of *Fusarium roseum* ‘*Graminearum*’ in eastern Australia. *Trans Br Mycol Soc* 68:421–427
- Garcia Júnior D, Vechiato MH, Menten JOM, Lima MIPM (2007) Influence of *Fusarium graminearum* on the germination of wheat. *Arquivos do Instituto Biológico (São Paulo)* 74:157–162
- Geiser DM, Ivey ML, Hakiza G, Juba JH, Miller SA (2005) *Gibberella xylarioides* (anamorph: *Fusarium xylarioides*), a causative agent of coffee wilt disease in Africa, is a previously unrecognized member of the *G. fujikuroi* species complex. *Mycologia* 97:191–201
- Gerlach W, Nirenberg HI (1982) The genus *Fusarium*-A pictorial atlas. *Mitt Biol Bundesanst Land- Forstwirtschaft Berlin-Dahlem* 209:1–406
- Gilbert J, Woods SM, Turkington TK, Tekauz A (2005) Effect of heat treatment to control *Fusarium graminearum* in wheat seed. *Can J Plant Pathol* 27:448–452
- Gilbertson RL, Brown WM, Ruppel EG, Capinera JL (1986) Association of corn stalk rot *Fusarium* spp. and Western corn rootworm beetles in Colorado. *Phytopathology* 76:1309–1314
- Glenn AE, Zitomer NC, Zimeri AM, Williams LD, Riley RT, Proctor RH (2008) Transformation-mediated complementation of a FUM gene cluster deletion in *Fusarium verticillioides* restores both fumonisin production and pathogenicity on maize seedlings. *Mol Plant Microbe Interact* 21:87–97
- González-Jaén MT, Mirete S, Patiño B, López-Errasquín E, Vázquez C (2004) Genetic markers for the analysis of variability and for production of specific diagnostic sequences in fumonisin-producing strains of *Fusarium verticillioides*. *Eur J Plant Pathol* 110:525–532
- Guo XW, Fernando WGD, Seow-Brock HY (2008) Population structure, chemotype diversity, and potential chemotype shifting of *Fusarium graminearum* in wheat fields of Manitoba. *Plant Dis* 92:756–762
- Gutierrez-Najera N, Munoz-Clares RA, Palacios-Bahena S, Ramirez J, Sanchez-Nieto S, Plasencia J, Gavilanes-Ruiz M (2005) Fumonisin B1, a sphingoid toxin, is a potent inhibitor of the plasma membrane H<sup>+</sup> -ATPase. *Planta* 221:589–596
- Halstensen AS, Nordby K, Klemsdal SS, Elen O, Clasen P, Eduard W (2006) Toxigenic *Fusarium* spp. as determinants of Trichothecene mycotoxins in settled grain dust. *J Occup Env Hyg* 3:651–659
- Haratin M, Sharifnabi B, Alizadeh A, Safaie N (2008) PCR analysis of the *Tri13* gene to determine the genetic potential of *Fusarium graminearum* isolates from Iran to produce Nivalenol and Deoxynivalenol. *Mycopathologia* 166:109–116
- Hohn TM, Beremand PD (1989) Isolation and nucleotide sequence of a sesquiterpene cyclase gene from the trichothecene-producing fungus *Fusarium sporotrichioides*. *Gene* 79:131–138
- Hsieh WH, Smith SN, Snyder WC (1977) Mating groups in *Fusarium moniliforme*. *Phytopathology* 67:1041–1043

- Inch S, Fernando WGD, Gilbert J (2005) Seasonal and daily variation in the airborne concentration of *Gibberella zeae* (Schw.) Petch spores in Manitoba. *Can J Plant Pathol* 27:357–363
- Jurado M, Vazquez C, Patino B, Gonzalez-Jaen MT (2005) PCR detection assays for the trichothecene-producing species *Fusarium graminearum*, *Fusarium culmorum*, *Fusarium poae*, *Fusarium equiseti* and *Fusarium sporotrichioides*. *Syst Appl Microbiol* 28:562–568
- Jurado M, Vázquez C, Marin S, Sanchis V, González-Jaén MT (2006) PCR-based strategy to detect contamination with mycotoxigenic *Fusarium* species in maize. *Syst Appl Microbiol* 29:681–689
- Klaasen JA, Nelson PE (1996) Identification of a mating population, *Gibberella nygamai* sp. nov., within the *Fusarium nygamai* anamorph. *Mycologia* 88:965–969
- Knoll S, Mulfinger S, Niessen L, Vogel RF (2002a) Rapid preparation of *Fusarium* DNA from cereals for diagnostic PCR using sonification and an extraction kit. *Plant Pathol* 51:728–734
- Knoll S, Vogel RF, Niessen L (2002b) Identification of *Fusarium graminearum* in cereal samples by DNA detection test stipestrate. *Lett Appl Microbiol* 34:144–148
- Kuhlman EG (1989) Varieties of *Gibberella fujikuroi* with anamorph in *Fusarium* section *Liseola*. *Mycologia* 74:759–768
- Lepoint PC, Munaut FT, Maraite HM (2005) *Gibberella xylarioides* sensu lato from *Coffea canephora*: a new mating population in the *Gibberella fujikuroi* species complex. *Appl Environ Microbiol* 71:8466–8471
- Leslie JF (1991) Mating populations in *Gibberella fujikuroi* (*Fusarium* section *Liseola*). *Phytopathology* 81:1058–1060
- Leslie JF, Summerell BA (2006) The *Fusarium* laboratory manual. Blackwell, Iowa, USA
- Link HF (1809) Observaciones en ordines plantarum naturalis, Dissetatio I. *Mag Ges Naturf Freunde Berlin* 3:3–42
- Logrieco A, Moretti A, Ritieni A, Bottalico A, Corda P (1995) Occurrence and toxigenicity of *Fusarium proliferatum* from preharvest maize ear rot, and associated mycotoxins, in Italy. *Plant Dis* 79:727–731
- Lopez-Erassquin E, Vazquez C, Jimenez M, González-Jaén MT (2007) Real-Time RT-PCR assay to quantify the expression of *Fum1* and *Fum19* genes from the fumonisin-producing *Fusarium verticillioides*. *J Microbiol Methods* 68:312–317
- Maldonado-Ramirez SL, Schmale DG, Shields EJ, Bergstrom GC (2005) The relative abundance of viable spores of *Gibberella zeae* in the planetary boundary layer suggests the role of long-distance transport in regional epidemics of *Fusarium* head blight. *Agr Forest Meteorol* 132:20–27
- Marasas WF, Kriek NP, Fincham JE, van Rensburg SJ (1984) Primary liver cancer and oesophageal basal cell hyperplasia in rats caused by *Fusarium moniliforme*. *Int J Cancer* 34:383–387
- Marasas WFO, Nelson PE, Toussoun TA (1988) Reclassification of two important moniliformin-producing strains of *Fusarium*, NRRL 6022 and NRRL 6322. *Mycologia* 80:407–410
- Marin S, Albareda X, Ramos AJ, Sanchis V (2001) Impact of environment and interactions of *Fusarium verticillioides* and *Fusarium proliferatum* with *Aspergillus parasiticus* on fumonisin B1 and aflatoxins on maize grain. *J Sci Food Agric* 81:1060–1068
- Marra M, Fogliano V, Zambardi A, Fullone MR, Nasta D, Aducci P (1996) The H<sup>+</sup>-ATPase purified from maize root plasma membranes retains fusicoccin *in vivo* activation. *FEBS Lett* 382:293–296
- Masuda D, Ishida M, Yamaguchi K, Yamaguchi I, Kimura M, Nishiuchi T (2007) Phytotoxic effects of trichothecenes on the growth and morphology of *Arabidopsis thaliana*. *J Exp Bot* 58:1617–1626
- Matusinsky P, Mikolasova R, Klem K, Spitzer T, Urban T (2008) The role of organic vs. conventional farming practice, soil management and preceding crop on the incidence of stem-base pathogens on wheat. *J Plant Dis Protect* 115:17–22
- Mayden RL (1997) A hierarchy of species concepts: the denouement in the saga of the species problem. In: Claridge MF, Dawah HA, Wilson MR (eds) *Species: the units of biodiversity*. Chapman & Hall, London, UK, pp 381–424

- McLaughlin CS, Vaughan MH, Campbell LM, Wei CM, Stafford ME, Hansen BS (1977) Inhibition of protein synthesis by trichothecenes. In: Rodricks JV, Hesseltn CW, Mehlman MA (eds) Mycotoxins in human and animal health. Pathotox Publishers, Park Forest South, pp 262–272
- Melcion D, Cahagnier B, Richard-Molard D (1997) Study of the biosynthesis of fumonisins B1, B2 and B3 by different strains of *Fusarium moniliforme*. Lett Appl Microbiol 24:301–305
- Miller JD, Greenhalgh K, Wang YZ, Lu M (1991) Trichothecene chemotypes of three *Fusarium* species. Mycologia 83:121–130
- Miller JD (1994) Epidemiology of *Fusarium* diseases of cereals. In: Miller J, Trenholm H (eds) Mycotoxins in grain: compounds other than aflatoxin. Eagan Press, St. Paul, MN, USA, pp 19–36
- Miller SS, Reid LM, Harris LJ (2007) Colonization of maize silks by *Fusarium graminearum*, the causative organism of gibberella ear rot. Can J Bot 85:369–376
- Mirete S, Vázquez C, Mulé G, Jurado M, González-Jaén MT (2004) Differentiation of *Fusarium verticillioides* from banana fruits by IGS and EF-1a sequence analyses. Eur J Plant Pathol 110:515–523
- Möller EM, Chelkowski J, Geiger HH (1999) Species-specific PCR assays for the fungal pathogens *Fusarium moniliforme* and *Fusarium subglutinans* and their application to diagnose maize ear rot disease. J Phytopathol 147:497–508
- Moretti A, Mulé G, Susca A, González-Jaén MT, Logrieco A (2004) Toxin profile, fertility and AFLP analysis of *Fusarium verticillioides* from banana fruits. Eur J Plant Pathol 110:601–609
- Mulé G, Susca A, Stea G, Moretti A (2004) A species-specific PCR assay based on the calmodulin partial gene for the identification of *Fusarium verticillioides*, *F. proliferatum* and *F. subglutinans*. Eur J Plant Pathol 110:495–502
- Munkvold GP (2003a) Cultural and genetic approaches to managing mycotoxins in maize. Annu Rev Phytopathol 41:99–116
- Munkvold GP (2003b) Epidemiology of *Fusarium* diseases and their mycotoxins in maize ears. Eur J Plant Pathol 109:705–713
- Munkvold GP, Carlton WM (1997) Influence of inoculation method on systemic *Fusarium moniliforme* infection of maize plants grown from infected seeds. Plant Dis 81:211–216
- Munkvold GP, Desjardins AE (1997) Fumonisins in maize: can we reduce their occurrence. Plant Dis 81:556–565
- Munkvold GP, McGee DC, Carlton WM (1997) Importance of different pathways for maize kernel infection by *Fusarium moniliforme*. Phytopathology 87:209–217
- Murillo I, Cavallarin L, San Segundo B (1998) The development of a rapid PCR assay for detection of *Fusarium moniliforme*. Eur J Plant Pathol 104:301–311
- Nelson PE, Toussoun TA, Marasas WFO (1983) *Fusarium* species: an illustrated manual for identification. The Pennsylvania State University Press, University Park
- Nelson PE, Plattner RD, Shackelford DD, Desjardins AE (1992) Fumonisin B1 production by *Fusarium* species other than *F. moniliforme* in section *Liseola* and by some related species. Appl Environ Microbiol 58:984–989
- Nelson PE, Desjardins AE, Plattner RD (1993) Fumonisins, mycotoxins produced by *Fusarium* species: biology, chemistry, and significance. Annu Rev Phytopathol 31:233–252
- Nelson PE, Dignani MC, Anaissie EJ (1994) Taxonomy, biology, and clinical aspects of *Fusarium* species. Clin Microbiol Rev 7:479–504
- Nicholson P, Simpson DR, Weston G, Rezanoor HN, Lees AK, Parry DW, Joyce D (1998) Detection and quantification of *Fusarium culmorum* and *Fusarium graminearum* in cereals using PCR assays. Physiol Mol Plant Pathol 53:17–37
- Niessen L, Vogel RF (1998) Group specific PCR-detection of potential trichothecene-producing *Fusarium*-species in pure cultures and cereal samples. Syst Appl Microbiol 21:618–631
- Niessen L, Schmidt H, Vogel RF (2004) The use of *tri5* gene sequences for PCR detection and taxonomy of trichothecene-producing species in the *Fusarium* section *Sporotrichiella*. Int J Food Microbiol 95:305–319

- Nirenberg H (1976) Investigations on the morphological and biological differentiation in the *Fusarium* section *Liseola*. Mitteilungen aus der Biologischen Bundesanstalt für Land- und Forstwirtschaft, Berlin-Dahlem, 117 pp
- Nirenberg HI (1989) Identification of *Fusaria* occurring in Europe on cereals and potatoes. In: Chelkowski J (ed) *Fusarium: mycotoxins, taxonomy, and pathology*. Elsevier, New York, pp 179–193
- Nirenberg HI, O'Donnell K (1998) New *Fusarium* species and combinations within the *Gibberella fujikuroi* complex. *Mycologia* 90:434–458
- Nyval RF, Kommdahl T (1968) Individual thickened hyphae as survival structures of *Fusarium moniliforme* in corn. *Phytopathology* 58:1704–1707
- O'Donnell K, Cigelnik E, Nirenberg HI (1998) Molecular systematics and phylogeography of the *Gibberella fujikuroi* species complex. *Mycologia* 90:465–493
- O'Donnell K, Nirenberg HI, Aoki T, Cigelnik E (2000) A multigene phylogeny of the *Gibberella fujikuroi* species complex: detection of additional phylogenetically distinct species. *Mycoscience* 41:61–78
- Ohsato S, Ochiai-Fukuda T, Nishiuchi T, Takahashi-Ando N, Koizumi S, Hamamoto H, Kudo T, Yamaguchi I, Kimura M (2007) Transgenic rice plants expressing trichothecene 3-O-acetyltransferase show resistance to the *Fusarium* phytotoxin deoxynivalenol. *Plant Cell Rep* 26:531–538
- Osborne LE, Stein JM (2007) Epidemiology of *Fusarium* head blight on small-grain cereals. *Int J Food Microbiol* 119:103–108
- Parry DW (1995) *Fusarium* ear blight (scab) in small grain cereals – a review. *Plant Pathol* 44:207–238
- Patino B, Mirete S, González-Jaén MT, Mulé G, Rodríguez MT, Vazquez C (2004) PCR detection assay of fumonisin-producing *Fusarium verticillioides* strains. *J Food Prot* 67:1278–1283
- Patino B, Mirete S, Vázquez C, Jiménez M, Rodríguez MT, González-Jaén MT (2006) Characterization of *Fusarium verticillioides* strains by PCR-RFLP analysis of the intergenic spacer region of the rDNA. *J Sci Food Agric* 86:429–435
- Phan HT, Burgess LW, Summerell BA, Bullock S, Liew ECY, Smith-White JL, Clarkson JR (2004) *Gibberella gaditjirrii* (*Fusarium gaditjirrii*) sp. nov., a new species from tropical grasses in Australia. *Stud Mycol* 50:261–272
- Ponte EM, del Fernandes JMC, Bergstrom GC (2007) Influence of growth stage on *Fusarium* head blight and deoxynivalenol production in wheat. *J Phytopathol* 155:577–581
- Powell RG, Plattner RD (1995) Fumonisin. In: Pelletier SW (ed) *Alkaloids, chemical and biological perspectives*. Pergamon Press, Oxford, pp 247–278
- Proctor RH, Hohn TM, McCormick SP (1995) Reduced virulence of *Gibberella zeae* caused by disruption of a trichothecene toxin biosynthetic gene. *Mol Biol Evol* 8:593–601
- Proctor RH, Desjardins AE, Plattner RD, Hohn TM (1999) A polyketide synthase gene required for biosynthesis of fumonisin mycotoxins in *Gibberella fujikuroi* mating population A. *Fungal Genet Biol* 27:100–112
- Proctor RH, Brown DW, Plattner RD, Desjardins AE (2003) Co-expression of 15 contiguous genes delineates a fumonisin biosynthetic gene cluster in *Gibberella moniliformis*. *Fungal Genet Biol* 38:237–249
- Proctor RH, Plattner RD, Desjardins AE, Busman M, Butchko RA (2006) Fumonisin production in the maize pathogen *Fusarium verticillioides*: genetic basis of naturally occurring chemical variation. *J Agric Food Chem* 54:2424–2430
- Ramirez ML, Chulze S, Magan N (2006) Temperature and water activity effects on growth and temporal deoxynivalenol production by two Argentinean strains of *Fusarium graminearum* on irradiated wheat grain. *Int J Food Microbiol* 106:291–296
- Reischer GH, Lemmens M, Farnleitner A, Adler A, Mach RL (2004) Quantification of *Fusarium graminearum* in infected wheat by species specific real-time PCR applying a TaqMan Probe. *J Microbiol Methods* 59:141–146

- Riley RT, Wang E, Schroeder JJ, Smith ER, Plattner RD, Abbas H, Yoo HS, Merrill AH Jr (1996) Evidence for disruption of sphingolipid metabolism as a contributing factor in the toxicity and carcinogenicity of fumonisins. *Nat Toxins* 4:3–15
- Rocha O, Ansari K, Doohan FM (2005) Effects of trichothecene mycotoxins on eukaryotic cells: a review. *Food Addit Contam* 22:369–378
- Schaafsma AW, Tamburic-Ilicic L, Hooker DC (2005) Effect of previous crop, tillage, field size, adjacent crop, and sampling direction on airborne propagules of *Gibberella zeae*/*Fusarium graminearum*, fusarium head blight severity, and deoxynivalenol accumulation in winter wheat. *Can J Plant Pathol* 27:217–224
- Schilling AG, Moller ME, Geiger HH (1996) Polymerase chain reaction-based assays for species-specific detection of *Fusarium culmorum*, *F. graminearum* and *F. avenaceum*. *Phytopathology* 86:515–522
- Schnerr H, Vogel RF, Niessen L (2002) Correlation between DNA of trichothecene-producing *Fusarium* species and Deoxynivalenol concentrations in wheat samples. *Lett Appl Microbiol* 35:121–125
- Seefelder W, Humpf HU, Schwerdt G, Freudinger R, Gekle M (2003) Induction of apoptosis in cultured human proximal tubule cells by fumonisins and fumonisin metabolites. *Toxicol Appl Pharmacol* 192:146–153
- Seo JA, Proctor RH, Plattner RD (2001) Characterization of four clustered and coregulated genes associated with fumonisin biosynthesis in *Fusarium verticillioides*. *Fungal Genet Biol* 34:155–165
- Shah DA, Pucci N, Infantino A (2005) Regional and varietal differences in the risk of wheat seed infection by fungal species associated with fusarium head blight in Italy. *Eur J Plant Pathol* 115:13–21
- Smith DR, White DG (1988) Diseases of corn. In: Sprague GF, Dudley JW (eds) *Corn and corn improvement*, 3rd edn. American Society of Agronomy, Madison, WI, pp 687–766
- Sobek EA, Munkvold GP (1999) European corn borer larvae as vectors of *Fusarium moniliforme*, causing kernel rot and symptomless infection of maize kernels. *J Econ Entomol* 92:503–509
- Sreenivasa MY, González Jaen MT, Dass RS, Raj APC, Janardhana GR (2008) A PCR-based assay for the detection and differentiation of potential fumonisin-producing *Fusarium verticillioides* isolated from Indian maize kernels. *Food Biotechnol* 22:160–170
- Steenkamp ET, Wingfield BD, Coutinho TA, Wingfield MJ, Marasas WF (1999) Differentiation of *Fusarium subglutinans* f. sp. *pini* by histone gene sequence data. *Appl Environ Microbiol* 65:3401–3406
- Steenkamp ET, Coutinho TA, Desjardins AE, Wingfield BD, Marasas WFO, Wingfield MJ (2001) *Gibberella fujikuroi* mating population E is associated with maize and teosinte. *Mol Plant Pathol* 2:215–221
- Sutton JC (1982) Epidemiology of wheat head blight and maize ear rot caused by *Fusarium graminearum*. *Can J Plant Pathol* 4:195–209
- Taylor JW, Jacobson DJ, Kroken S, Kasuga T, Geiser DM, Hibbett DS, Fisher MC (2000) Phylogenetic species recognition and species concepts in fungi. *Fungal Genet Biol* 31:21–32
- Toussoun TA, Nelson PE (1975) Variation and speciation in the *Fusaria*. *Annu Rev Phytopathol* 13:71–82
- Trail F, Gaffoor I, Vogel S (2005) Ejection mechanics and trajectory of the ascospores of *Gibberella zeae* (anamorph *Fusarium graminearum*). *Fungal Genet Biol* 42:528–533
- Tschanz AT, Horst RK, Nelson PE (1976) The effect of environment on sexual reproduction of *Gibberella zeae*. *Mycologia* 68:327–340
- Van Asch MAJ, Rijkenberg FHJ, Coutinho TA (1992) Phytotoxicity of fumonisin B1, moniliformin, and T-2 toxin to corn callus cultures. *Phytopathology* 82:1330–1332
- Visentin I, Tamiotti G, Valentino D, Portis E, Karlovsky P, Moretti A, Cardinale F (2009) The ITS region as a taxonomic discriminator between *Fusarium verticillioides* and *Fusarium proliferatum*. *Mycol Res* (in press)



- Voigt K, Schleier S, Bruckner B (1995) Genetic variability in *Gibberella fujikuroi* and some related species of the genus *Fusarium* based on random amplification of polymorphic DNA (RAPD). *Curr Genet* 27:528–535
- Waalwijk C, de Koning JRA, Gams W (1996) Discordant groupings of *Fusarium* spp. from sections *Elegans*, *Liseola* and *Dlaminia* based on ribosomal ITS1 and ITS2 sequences. *Mycologia* 88:361–368
- Waalwijk C, de Vries IM, Köhl J, Xu X, van der Lee TAJ, Kema GHJ (2008a) Development of quantitative detection methods for *Fusarium* in cereals and their application. In: Leslie J, Bandyopadhyay R, Visconti A (eds) *Mycotoxins: detection methods, management Public Health and Agricultural Trade*. CAB International, Wallingford, UK, pp 195–205
- Waalwijk C, Koch SH, Ncube E, Allwood J, Flett B, de Vries I, Kema GHJ (2008b) Quantitative detection of *Fusarium* spp. and its correlation with fumonisin content in maize from South African subsistence farmers. *World Mycotoxin J* 1:39–47
- Walton JD (2000) Horizontal gene transfer and the evolution of secondary metabolite gene clusters in fungi: an hypothesis. *Fungal Genet Biol* 30:167–171
- Wang H, Hwang SF, Eudes F, Chang KF, Howard RJ, Turnbull GD (2006) Trichothecenes and aggressiveness of *Fusarium graminearum* causing seedling blight and root rot in cereals. *Plant Pathol* 55:224–230
- Ward TJ, Bielawski JP, Kistler HC, Sullivan E, O'Donnell K (2002) Ancestral polymorphism and adaptive evolution in the trichothecene mycotoxin gene cluster of phytopathogenic *Fusarium*. *Proc Natl Acad Sci USA* 99:9278–9283
- Wevelsiep L, Ruppig E, Knogge W (1993) Stimulation of barley plasmalemma H<sup>+</sup>-ATPase by phytotoxic peptides from the fungal pathogen *Rhynchosporium secalis*. *Plant Physiol* 101:297–301
- White TJ, Burns T, Lee S, Taylor JW (1990) Amplification and direct sequencing of fungal ribosomal RNA genes for phylogenetics. In: Innis MA, Gelfand DH, Sninsky JJ, White TJ (eds) *PCR protocol: a guide to methods and application*. Academic Press, New York, pp 315–322
- Widestrand J, Pettersson H (2001) Effect of time, temperature and solvent on the stability of T-2 toxin, HT-2 toxin, deoxynivalenol and nivalenol calibrants. *Food Addit Contam* 18:987–992
- Wiley EO (1978) The evolutionary species concept reconsidered. *Syst Zool* 27:17–26
- Williams LD, Glenn AE, Bacon CW, Smith MA, Riley RT (2006) Fumonisin production and bioavailability to maize seedlings grown from seeds inoculated with *Fusarium verticillioides* and grown in natural soils. *J Agric Food Chem* 54:5694–5700
- Wollenweber HW, Reinking OA (1935) *Die Fusarien, ihre Beschreibung. Schadwirkung und Bekämpfung*, Paul Parey, Berlin
- Xu JR, Yan K, Dickman M, Leslie JF (1995) Electrophoretic karyotypes distinguish the biological species of *Gibberella fujikuroi* (*Fusarium* section *Liseola*). *Mol Plant Microbe Interact* 8:74–84
- Xu XM, Parry DW, Nicholson P, Thomsett MA, Simpson D, Edwards SG, Cooke BM, Doohan FM, Monaghan S, Moretti A, Tocco G, Mule G, Hornok L, Béki E, Tatnell J, Ritieni A (2008) Within-field variability of *Fusarium* head blight pathogens and their associated mycotoxins. *Eur J Plant Pathol* 120:21–34
- Yoshida M, Kawada N, Nakajima T (2007) Effect of infection timing on *Fusarium* head blight and mycotoxin accumulation in open- and closed-flowering barley. *Phytopathology* 97:1054–1062
- Zeller K, Summerell BA, Bullock S, Leslie JF (2003) *Gibberella konz* (*Fusarium konzum*) sp. nov., a new species within the *Gibberella fujikuroi* complex from native prairie grasses. *Mycologia* 95:943–954
- Zhang YQ, Wilkinson H, Keller NP, Tsitsigiannis D (2004) Secondary metabolite gene clusters. In: An Z (ed) *Handbook of industrial mycology*. Marcel Dekker, New York, pp 355–386

# Chapter 7

## Molecular Detection and Identification of *Fusarium oxysporum*

Ratul Saikia and Narendra Kadoo

**Abstract** *Fusarium oxysporum* is a ubiquitous inhabitant of soils worldwide and causes diseases such as wilt, yellows, and damping-off in different plant species. Rapid and reliable detection of the pathogen is essential for undertaking appropriate and timely disease management measures. The time-consuming and laborious classical detection methods are now being increasingly replaced by culture-independent molecular detection techniques, which are much faster, more specific, and sensitive. Molecular techniques like microarrays, whole genome sequencing, DNA barcoding, metagenomics etc. can identify a large number of isolates in a single assay. Some of the emerging tools will also allow complete analysis of developmental processes that are characteristics of the fungus, including the molecular nature of pathogenicity.

### 7.1 Introduction

*Fusarium oxysporum* Schlechtend. Fr. is an important asexual species complex and is well represented among the soil borne fungi in every type of soil all over the world (Burgess 1981). *F. oxysporum* includes morphologically indistinguishable pathogenic, nonpathogenic, and even beneficial strains. The pathogenic strains cause diseases such as vascular wilt, yellows, root rot, and damping-off in a wide variety of economically important crops (Beckman and Roberts 1995), while the

---

R. Saikia

Biotechnology Division, North-East Institute of Science & Technology, Jorhat, 785006, Assam, India

e-mail: rsaikia19@yahoo.com

N. Kadoo

PMB Group, Biochemical Sciences Division, National Chemical Laboratory, Pune 411008, Maharashtra, India

e-mail: ny.kadoo@ncl.res.in

Both the authors have contributed equally to the manuscript.

nonpathogenic strains are defined as the strains for which no host plants have been identified (yet) (Lievens et al. 2008). As a species, *F. oxysporum* probably causes more economic damage to agricultural crops than any other pathogen. In spite of the broad host range of the species as a whole, individual strains usually infect only a single or a few plant species. These individual fungal strains usually show a high level of host specificity and, based on the plant species they can infect, they have been classified into more than 120 *formae speciales* (Armstrong and Armstrong 1981); for example, *F. oxysporum* f.sp. *ciceri* causes wilt only in chickpea. However, some *formae speciales* such as *F. oxysporum* f.sp. *radicis-cucumerinum*, and *F. oxysporum* f.sp. *radicis-lycopersici* have broader host ranges, which, apart from infecting cucumber and tomato respectively, can cause root and stem rot on multiple hosts from different plant families (Lievens et al. 2008). Isolates from a particular *forma specialis* can be further subdivided into physiological races based on cultivar specificity. In addition, based on the ability to form heterokaryons, *F. oxysporum* strains have been grouped into vegetative compatibility groups (VCGs; Puhalla 1985), and different *formae speciales* and races may contain multiple VCGs (Katan 1999; Katan and Di Primo 1999). Thus, with regard to effective management of the pathogen, identification below the species level is essential.

Identification of *F. oxysporum* pathotypes is traditionally based on the combination of diagnostic symptoms on the host and the presence of the fungus in the affected tissues (Baayen et al. 2000). However, this classical approach is becoming increasingly challenging because more than one *forma specialis* may infect a particular host, along with nonpathogenic strains, which are common soil and rhizosphere inhabitants (Edel et al. 2000). Genetic differences among *F. oxysporum formae speciales* have been evaluated through the analyses of pathogenicity, VCG, chromosomal features, ribosomal DNA (rDNA), mitochondrial DNA (mtDNA), and other molecular markers (Jacobson and Gordon 1990; Puhalla 1985; Katan 1999; Appel and Gordon 1995; O'Donnell et al. 1998; Alves-Santos et al. 1999). However, molecular discrimination of *F. oxysporum* is complicated by the observation that different isolates classified into a single *forma specialis* may have independent evolutionary (polyphyletic) origins (O'Donnell et al. 1998; Baayen et al. 2000; Skovgaard et al. 2001; Cramer et al. 2003), and that isolates that belong to different *formae speciales* may share a common ancestor (monophyletic origin; Kistler 1997).

Technological advances in molecular detection methods allow quick and accurate detection and quantification of plant pathogens and these are now being applied to practical problems. The information resulting from such experiments could be used to monitor the level of exposure of the crop to pathogen inoculum and to improve disease control by allowing more rational decisions to be made about the choice and use of fungicides and resistant cultivars. With all these approaches, implementation of appropriate disease management measures requires timely detection and reliable identification of the pathogen and its races. Early and reliable detection is crucial for the containment of the disease and implementation of disease control strategies when they are likely to be most effective. In recent years, the increasing use of molecular methods in fungal diagnostics has emerged

as a possible answer to the problems associated with existing phenotypic identification systems. Here we review the present scenario and emerging advances in molecular identification of plant pathogenic *F. oxysporum*, and discuss how this knowledge can help in managing the pathogen.

## 7.2 Earlier Efforts for Identification of Pathogenic *Fusarium oxysporum*

Classically, plant pathogenic fungi were characterized by a series of morphological criteria including cultural characteristics on growth media and diagnostic symptoms on the host along with the presence of the fungus in the affected tissues (Baayen et al. 2000). However, accurate identification of fungi by visual examination of such morphological criteria is very difficult and erroneous. Moreover, these methods have other major limitations such as, reliance on the ability of the fungus to be cultured, time-consuming and laborious nature of identification process, and the requirement for extensive taxonomical knowledge, which complicate timely disease management decisions. Therefore, attempts are being made to replace these methods with molecular identification techniques. As a result, in the last two decades, molecular tools have had a major impact on the identification of plant pathogens. Molecular techniques can avoid many of the drawbacks associated with classical methods of pathogen identification and can also improve our understanding of pathogen detection in different conditions. In general, these techniques are more specific, sensitive, and accurate than traditional methods, and do not demand specialized taxonomical expertise. Today, a wide range of molecular techniques are being applied to accurately identify *F. oxysporum* isolates (Table 7.1), of which those based on detection of pathogen DNA or RNA are the most predominant.

### 7.2.1 Identification Using Anonymous Markers

Anonymous marker techniques like restriction fragment length polymorphism (RFLP), random amplified polymorphic DNA (RAPD), amplified fragment length polymorphism (AFLP), etc. have been successfully used for identification of *F. oxysporum* isolates by several workers.

#### 7.2.1.1 Restriction Fragment Length Polymorphism

Restriction Fragment Length Polymorphisms (RFLPs) have been extensively used to characterize *F. oxysporum* isolates and VCGs (Flood et al. 1992; Manicom and Baayen 1993; Fernandez et al. 1994; Mes et al. 1994; Appel and Gordon 1995;

**Table 7.1** Molecular techniques used for identification, detection, or genetic diversity analysis of some *formae speciales* of *Fusarium oxysporum*

<i>F. oxysporum</i> forma <i>specialis</i>	Method of analysis	References
<i>asparagi</i>	Amplified Fragment Length Polymorphism (AFLP)	Baayen et al. (2000)
<i>albedinis</i>	DNA fingerprinting (DF), Restriction Fragment Length Polymorphism (RFLP), Random Amplified Polymorphic DNA (RAPD), Vegetative Compatibility Grouping (VCG)	Fernandez and Tantaoui (1994); Fernandez et al. (1995)
<i>cicari</i>	RFLP, VCG, RAPD, IGS-RFLP, ISSR	Perez-Artes et al. (1995); Honarreddy and Dubey (2006); Singh et al. (2006); Bayraktar et al. (2008)
<i>conglutinans</i>	DF, isozyme analysis (ISA), Plasmid DNA profile (PDP), RFLP, VCG	Bosland and Williams (1987); Kistler et al. (1987, 1991); Kistler and Benny (1989); Hirota et al. (1992)
<i>cutense</i>	Electrophoretic karyotyping (EK), DF, ISA, RFLP, RAPD, VCG, AFLP	Miao (1990); Ploetz (1990); Kistler et al. (1991); Koenig et al. (1993); Boehm et al. (1994); Bentley et al. (1995); O'Donnell et al. (1998); Baayen et al. (2000); Gerlach et al. (2000); Groenewald et al. (2006)
<i>cucumerinum</i>	DF, RAPD	Namiki et al. (1994); Lievens et al. (2007)
<i>cyclaminis</i>	DF, RFLP, VCG	Woudt et al. (1995)
<i>dianthi</i>	RFLP, VCG, AFLP	Manicom et al. (1990); Manicom and Baayen (1993); Baayen et al. (2000)
<i>elaedis</i>	RFLP, VCG	Flood et al. (1992)
<i>gladioli</i>	DF, RAPD, VCG, AFLP	Mes et al. (1994), Baayen et al. (2000)
<i>lini</i>	AFLP, VCG	Baayen et al. (2000)
<i>lycopersici</i>	ISA, RAPD, RFLP, VCG, AFLP	Elias and Schneider (1991, 1992); Elias et al. (1993); Baayen et al. (2000)
<i>melonis</i>	DF, RFLP, DNA sequence comparison (DSC), VCG	Jacobson and Gordon (1990); Namiki et al. (1994); Appel and Gordon (1995)
<i>niveum</i>	EK, DF, RFLP, VCG	Kim et al. (1993); Namiki et al. (1994)

<i>opuntiarum</i>	VCG, AFLP	Baayen et al. (2000)
<i>phaseoli</i>	RAPD	Alves-Santos et al. (2002)
<i>pisi</i>	DF, RAPD, VCG	Whitehead et al. (1992); Bodker et al. (1993); Grajal-Martin et al. (1993)
<i>radicis-cucumerinum</i>	RAPD	Lievens et al. (2007)
<i>radicis-lycopersici</i>	RFLP, VCG	Katan et al. (1991)
<i>raphani</i>	DF, ISA, PLP, RFLP, VCG	Bosland and Williams (1987); Kistler et al. (1987, 1991); Kistler and Benny (1989); Hirota et al. (1992)
<i>tulipae</i>	VCG, AFLP	Baayen et al. (2000)
<i>vasinfectum</i>	RAPD, RFLP, VCG, AFLP	Fernandez et al. (1994b); Abd-Elsalam et al. (2002a, 2004); Abo et al. (2005)

Baayen et al. 1997; Kistler 1997). Baayen et al. (1998) screened isolates of *F. oxysporum* from lily (*F. oxysporum* f.sp. *lili*) for pathogenicity, vegetative compatibility, and RFLP patterns, and compared these to reference isolates of the *formae speciales gladioli* and *tulipae*. They found that the isolates from Europe and United States shared unique RFLP patterns and belonged to the same VCG. RFLP analysis of *Fusarium* isolates from carnation by Manicom et al. (1990) and Manicom and Baayen (1993) showed two major VCGs, each characterized by a distinct RFLP pattern. Similarly, Fernandez et al. (1994) used RFLP analysis to identify four ribosomal DNA (rDNA) and seven mitochondrial DNA (mtDNA) haplotypes in *F. oxysporum* f.sp. *vasinfectum*, the causal organism of cotton wilt. Attitalla et al. (2004) evaluated isozyme analysis, mtDNA-RFLP, and high performance liquid chromatography (HPLC) to differentiate two morphologically indistinguishable *formae speciales* of *F. oxysporum*, *lycopersici*, and *radicis-lycopersici*. Although HPLC produced distinct profiles for nonpathogenic and pathogenic isolates, the direct mtDNA-RFLP technique proved to be an efficient diagnostic tool for routine differentiation of *lycopersici* and *radicis-lycopersici* isolates (Attitalla et al. 2004). However, although RFLP has been successfully used in many studies to identify *Fusarium* isolates, due to its labor-intensive nature, elaborate procedure, and the need for high amount of DNA (Garcia-Mas et al. 2000), it is being replaced by polymerase chain reaction (PCR) based techniques.

PCR allows rapid detection and identification of pathogens and overcomes most of the limitations of classical approaches. It has revolutionized the detection of pathogens and PCR-based methods are now widely used for identification of a variety of pathogens because of its rapid, sensitive, and specific nature. Many PCR-based approaches have been reported for identification of *F. oxysporum* isolates and the study of the genetic relationships among them. These fungi have been differentiated using either mycotoxigenic genes, ribosomal DNA, other genes, or unique DNA bands from RAPD analysis (reviewed by Edwards et al. 2002).

### 7.2.1.2 Random Amplified Polymorphic DNA

Random amplified polymorphic DNA (RAPD) is a quick and cost-effective method to detect pathogens and study the genetic similarity or diversity among pathogen populations. The technique has been extensively used to analyze genetic diversity among different *F. oxysporum formae speciales*, and races (Grajal-Martin et al. 1993; Bentley et al. 1994; Kelly et al. 1994; Manulis et al. 1994; Wright et al. 1996). Paavanen-Huhtala et al. (1999) analyzed 27 *F. oxysporum* isolates by RAPD and isozyme patterns; however, all the isolates could only be distinguished from each other by RAPD analysis. Mes et al. (1999) screened two races of *F. oxysporum* f.sp. *lycopersici* for vegetative compatibility and characterized them using RAPD analysis, and found that the RAPD profiles coincided with the vegetative compatibility groups.

The RAPD technique has been used to differentiate a collection of isolates into races corresponding to pathogenicity tests in cotton (Assigbetse et al. 1994) and basil (Chiocchetti et al. 1999; Chiocchetti 2001). Jimenez-Gasco et al. (2001)

identified specific RAPD amplification profiles for *F. oxysporum* f.sp. *ciceri* races 0, 1B/C, 5, and 6. Using RAPD-generated DNA probes, Wang et al. (2001) developed a sensitive and specific method for identifying *F. oxysporum* f.sp. *cucumerinum* and *F. oxysporum* f.sp. *luffae* isolates. After RAPD analysis of 13 *formae speciales* of *F. oxysporum*, they selected specific DNA bands as probes and developed *forma specialis*-specific probes for identification of *F. oxysporum* f.sp. *cucumerinum* and *F. oxysporum* f.sp. *luffae* isolates by dot blot hybridization.

Lievens et al. (2007) developed a robust RAPD marker-based assay to specifically detect and identify the cucumber pathogens *F. oxysporum* f.sp. *cucumerinum* and *F. oxysporum* f.sp. *radicis-cucumerinum*. Based on the phylogeny of *translation elongation factor-1a* (*TEF-1a*), they found that *F. oxysporum* f.sp. *cucumerinum* strains were genetically more diverse, while the *F. oxysporum* f.sp. *radicis-cucumerinum* strains clustered in a separate clade. The developed markers were implemented in a DNA array to enable parallel and sensitive detection and identification of the pathogens in complex samples from diverse origins. However, although the RAPD technique has been successfully used in many studies for detection and identification of *F. oxysporum* isolates as well as to evaluate the genetic diversity within and among pathogen populations, it suffers from well-known limitations of poor reproducibility and inter-laboratory transferability.

### 7.2.1.3 Amplified Fragment Length Polymorphism

Amplified fragment length polymorphism (AFLP) has been used in many studies for the analysis of fungal population structure (Majer et al. 1996; Gonzalez et al. 1998; DeScenzo et al. 1999; Purwantara et al. 2000; Zeller et al. 2000). Genetic variation among pathogenic isolates of *F. oxysporum* was estimated using AFLP markers by several workers (Baayen et al. 2000; Bao et al. 2002; Sivaramakrishan et al. 2002; Groenewald et al. 2006; Stewart et al. 2006). Later, the utility, reproducibility, and efficiency of AFLP technique led to its broader application in the analysis of population diversity and identification of pathogens (Baayen et al. 2000; Abd-Elsalam et al. 2002a, b; Kiprof et al. 2002; Sivaramakrishan et al. 2002; Abdel-Satar et al. 2003; Leslie et al. 2005; Gurjar et al. 2009). The technique was used to examine genetic relationships among isolates of *F. oxysporum* f.sp. *vasinfectum* by Abd-Elsalam et al. (2004) and Wang et al. (2006). Gurjar et al. (2009) identified two *F. oxysporum* f.sp. *ciceri* races (1 and 2) based on unique AFLP patterns. Sequence characterization of these race-specific AFLP products revealed significant homologies with metabolically important fungal genes. However, as AFLP is relatively costly and has a rather complicated technical procedure, it is being increasingly replaced by simpler PCR-based methods.

### 7.2.1.4 Simple Sequence Repeats

Simple sequence repeats (SSRs), also known as microsatellites, provide a powerful tool for taxonomic and population genetics studies. They have also been used in



fungal studies because of the high resolution that they provide (Bogale et al. 2005, 2006; Bayraktar et al. 2008). van der Nest et al. (2000) used inter-simple sequence repeat (ISSR) and SSR primers (random amplified microsatellites, RAMS) in PCR to develop SSR markers for *F. oxysporum*. Barve et al. (2001) assessed the genetic variability in *F. oxysporum* f.sp. *ciceri* (Foc) populations prevalent in India using 13 oligonucleotide probes and 11 restriction enzymes. Using the distribution of microsatellite repeats, it was found that races 1 and 4 were closely related as compared to race 2, while race 3 of the pathogen was very distinct.

However, as these anonymous marker techniques have several disadvantages, diagnostic DNA fragments identified with these approaches have often been converted into more simple and reliable molecular markers like sequence characterized amplified region (SCAR) or sequence tagged sites (STS). This approach has proven to be effective for the identification of several *formae speciales* and races of *F. oxysporum*. For example, Kelly et al. (1998) developed an *in planta* PCR method to detect isolates of race 5 of Foc in chickpea. The assay using RAPD-derived SCAR markers specifically identified race 5 of the pathogen from infected chickpea plants. Similarly, Jimenez-Gasco and Jimenez-Diaz (2003) sequenced previously identified Foc specific RAPD markers and designed SCAR markers to identify Foc and its four pathogenic races 0, 1A, 5, and 6. The assays were sensitive enough to detect as low as 100 pg of fungal genomic DNA. Based on RAPD analysis, Shimazu et al. (2005) developed three sets of STS markers for specific identification of three races of *F. oxysporum* f.sp. *lactucae*. These markers were specific to *F. oxysporum* f.sp. *lactucae* and did not amplify DNA from isolates of five other *F. oxysporum* *formae speciales* as well as other plant pathogenic fungi, bacteria, or plant materials examined in the study.

## 7.2.2 Identification Using Sequence-Specific Markers

Although the above-mentioned techniques have been successful in accurately identifying the pathogens in many cases, the markers can be localized anywhere in the pathogen genome and often little sequence data are available in public databases for comparison with other sequences. Therefore, extensive screening using a large collection of strains is necessary to validate the robustness of these markers. Lievens et al. (2008) listed specific PCR primers for the detection and identification of several *formae speciales* and races of *F. oxysporum*. Such markers that are based on specific DNA sequences in the pathogen genomes could be used for pathogen identification as well as for their phylogenetic studies.

### 7.2.2.1 ITS and IGS

The internal transcribed spacer (ITS) and intergenic spacer (IGS) regions of the ribosomal RNA genes possess characteristics that allow pathogen identification

(Ward 1994; Appel and Gordon 1995; Waalwijk et al. 1996; Edel et al. 2000; Bao et al. 2002; Singh et al. 2006). Bateman et al. (1996) used PCR-RFLP of a PCR product consisting of ITS1, 5.8S and ITS2 ribosomal DNAs, and eight restriction enzymes to distinguish 18 *Fusarium* haplotypes, while Edel et al. (1997) analyzed further into the 5' end of the 28S rDNA gene to distinguish five *Fusarium* haplotypes. However, neither of these methods could distinguish among *F. crookwellense*, *F. culmorum*, and *F. graminearum*, indicating that these *formae speciales* might be more closely related. Indeed, Schilling et al. (1996) later found that the DNA sequence of ITS1 region from *F. culmorum* and *F. graminearum* was identical. Additionally, species-specific primers could not be designed due to minor differences in the ITS2 region of the two *Fusarium* species. Mishra et al. (2003) developed a fluorescent marker-based PCR assay for rapid and reliable identification of five toxigenic and pathogenic *Fusarium* species viz. *F. oxysporum*, *F. avenaceum*, *F. culmorum*, *F. equiseti*, and *F. sambucinum*. The method was based on PCR amplification of species-specific DNA fragments using fluorescent oligonucleotide primers designed from ITS region of rDNA.

Similarly, Abd-Elsalam (2003) developed taxon-selective primers using ITS sequences for quick identification of the *Fusarium* genus, while Abd-Elsalam et al. (2006) identified *F. oxysporum* f.sp. *vasinfectum* (Fov) using specific primers based on the 16S and 23S rRNA genes. Based on differences in ITS sequences of *Fusarium* and *Mycosphaerella* spp., Zhang et al. (2005) developed species-specific PCR assays for rapid and accurate detection of *F. oxysporum* f.sp. *niveum* and *Mycosphaerella melonis* from diseased watermelon plants and infested soil. They also developed real-time quantitative PCR assays to detect and monitor the pathogens directly in soil samples. Zambounis et al. (2007) used PCR-RFLP and real-time PCR for detection and quantification of Australian isolates of *F. oxysporum* f.sp. *vasinfectum*. PCR-RFLP based on the rDNA-IGS region distinguished these isolates from other *formae speciales* of *F. oxysporum*. Further, they identified single-nucleotide polymorphisms (SNPs) in the 5' portion of the IGS region and developed two specific real-time PCR assays based on these SNPs for absolute quantification of genomic DNA from the isolates obtained from infected cotton tissues as well as soil samples. Similarly, three *Fusarium* species from *Dendrobium* were characterized by Latiffah et al. (2009) using PCR-RFLP of ITS in 5.8S rRNA region. They found that isolates from the same species produced similar PCR-RFLP patterns and UPGMA cluster analysis of the data clearly grouped *F. oxysporum*, *F. proliferatum*, and *F. solani* into separate clusters. Likewise, Gurjar et al. (2009) differentiated *F. oxysporum* f.sp. *ciceri* race 3 from the races 1, 2, and 4 based on the polymorphisms obtained with ITS-RFLP and ISSR approaches.

### 7.2.2.2 Transposons

Mouyna et al. (1996) analyzed the South American populations of *F. oxysporum* f.sp. *elaedis* (an oil palm pathogen) and found that they had the *palm* transposon. They also showed that the *palm* transposon was present in all the pathogenic

isolates, but was absent in all the nonpathogenic isolates, indicating that the pathogenic populations may be marked by the transposon. Fernandez et al. (1998) designed specific primers for detection of *F. oxysporum* f.sp. *albedinis* (the date palm pathogen), based on the sequences of transposable element *Fot1*. They analyzed a large number of *Fusarium* isolates, including 286 *F. oxysporum* f.sp. *albedinis* isolates, 17 other *formae speciales*, nonpathogenic *F. oxysporum* isolates, and eight other *Fusarium* species and the specific primer amplified a 400-bp fragment only in *F. oxysporum* f.sp. *albedinis*. A diagnostic PCR assay to detect pathogenic *F. oxysporum* races causing wilt in carnation was developed by Chiocchetti et al. (1999). This strategy was based on the genetic characterization of strains using different transposons and cloning and sequencing the regions flanking the insertion sites of these elements, followed by construction of race-specific primers for quick pathogen identification. Using a similar approach, Pasquali et al. (2007) developed inter-retrotransposon sequence characterized amplified regions (IR-SCAR) technique to differentiate *F. oxysporum* f.sp. *lactucae* race 1 isolates from other *F. oxysporum* and *F. oxysporum* f.sp. *lactucae* isolates. Interestingly, the robust RAPD marker-based assay developed by Lievens et al. (2007) to specifically detect and identify the economically important cucumber pathogen *F. oxysporum* f.sp. *radicis-cucumerinum* showed strong similarity with *Folyt1*, a transposable element identified in the tomato wilt pathogen *F. oxysporum* f.sp. *lycopersici*.

### 7.2.2.3 Other Genes

Mule et al. (2004) developed PCR assays for rapid identification of *F. oxysporum* and *F. proliferatum* in asparagus plants based on the *calmodulin* gene sequences, while Hirano and Arie (2006) designed specific primer sets based on nucleotide differences in *endo-polygalacturonase* (*pg1*) and *exo-polygalacturonase* (*pgx4*) genes from *F. oxysporum* f.sp. *lycopersici* and *radicis-lycopersici*, infecting tomato. A combination of amplifications from four primer sets allowed effective differentiation of the isolates into *formae speciales* and races. A PCR-RFLP technique based on *TEF-1a* gene sequences was designed by Bogale et al. (2007) to distinguish *Fusarium redolens* and three *formae speciales* of *F. oxysporum*. van der Does et al. (2008) found that, despite their polyphyletic origin, the *F. oxysporum* f.sp. *lycopersici* isolates contained an identical genomic region of at least 8 kb that was absent in other *formae speciales* as well as nonpathogenic isolates, and comprised the genes *SIX1*, *SIX2*, and *SHH1*. They further found that *SIX3*, which lies elsewhere on the same chromosome, was also unique to *F. oxysporum* f.sp. *lycopersici* isolates.

Recently, five different approaches *viz.* gene-specific markers, sequence analysis of *TEF-1a*, ITS-RFLP, ISSR, and AFLP were used to distinguish four *F. oxysporum* f.sp. *ciceri* (Foc) races, infecting chickpea (Gurjar et al. 2009). Unique AFLP patterns identified the races 1 and 2, while race 4 was distinguished from other races by the absence of amplification product of *xylanase-3* gene in this race. The Foc race 3 was differentiated from races 1, 2, and 4 based on the polymorphisms

obtained with ITS-RFLP and ISSR approaches as well as amplification profiles of *Hop78* transposon, *cutinase*, and *desaturase* genes. However, phylogenetic analysis of *TEF-1a* data from the four races revealed that race 3 was actually *Fusarium proliferatum* and not *F. oxysporum* as has been considered till now (Gurjar et al. 2009).

#### 7.2.2.4 Multiplex PCR

Multiplex PCR allows simultaneous and sensitive detection of different DNA or RNA targets in a single reaction. It can therefore, be designed to determine the presence of more than one pathogen in plant material by selectively amplifying specific sequences in two or more of them, or to detect related pathogens on multiple hosts (Louws et al. 1999). Simultaneous identification of several plant pathogens using multiplex PCR has been reported by Hamelin et al. (1996) and de Haan et al. (2000). Demeke et al. (2005) developed a species-specific PCR assay for identification of nine *Fusarium* species viz. *avenaceum*, *acuminatum*, *crookwellense*, *culmorum*, *equiseti*, *graminearum*, *poae*, *pseudograminearum*, and *sporotrichioides* in pure mycelial culture. Later, they could also simultaneously and accurately identify *F. culmorum*, *F. graminearum*, and *F. sporotrichioides* using multiplex PCR. If such specific primers are developed for common *F. oxysporum* *formae speciales* or physiological races, it would greatly simplify their multiplexed detection and identification for timely disease control. However, development of an efficient multiplex PCR requires optimization of reaction conditions in order to discriminate several amplicons per reaction (Elnifro et al. 2000).

#### 7.2.3 Limitations of PCR-Based Techniques

Although PCR-based techniques are rapid, highly sensitive, and specific, they might suffer from robustness (van der Wolf et al. 2001). The failure of PCR amplification to correctly diagnose infected and noninfected plant material has been reported in different comparative assays. Carry-over contamination of amplicons could be responsible for false-positive results, while the presence of inhibitor components in sample extracts is the main reason for false negatives. Similarly, PCR based techniques (except reverse transcriptase-PCR) can amplify the target DNA sequences from both active and nonactive or dead pathogen cells/spores (Malorny et al. 2003). Therefore, PCR might yield false positive results in some cases. Another important limitation of PCR-based identification assays is that the technique is not immediately quantitative. Although it is comparatively easy to quantify the amount of a PCR product produced as a result of a successful PCR amplification, it is difficult to estimate the amount of target DNA initially present at the start of the reaction. This is because the reaction rate is exponential; as a result, slight variations in the amplification procedure can generate different amounts of

final product from the same amount of starting material. Although, target DNA can be quantified using competitive PCR (Nicholson et al. 1998), this method is labor intensive. However, many of these limitations could be overcome by using modern techniques like real-time PCR and microarrays, which are increasingly being used for routine pathogen identification.

### 7.3 Recent Techniques for Identification of *Fusarium oxysporum*

Currently, the detection of plant pathogens is a changing, dynamic, and evolving world where established protocols can be modified or optimized only months after having been developed. Accurate and routine pathogen detection requires high levels of specificity, sensitivity, reliability, and speed. In this context, specificity can be defined as the capability to detect the pathogen in the absence of false positives and negatives, while sensitivity relates to the lowest number of pathogens reliably detected per assay or sample (Lopez et al. 2003). In addition, pathogen quantification is also becoming important, since it serves as a basis for establishing damage thresholds at which a pathogen causes disease, and action thresholds that determine when measures should be taken to limit or prevent losses (Lievens et al. 2008). As *F. oxysporum* is known to survive and remain latent in soil for many years, detection methods of high sensitivity, specificity, and reliability are required. The battery of available techniques and probes for detection of plant pathogens has increased considerably over the last few years. In addition to time benefits, there are great advantages in terms of specificity, sensitivity, and reliability with these techniques, as well as, they allow identification of the pathogen camouflaged by other microorganisms. Some of such modern techniques currently used in identification of plant pathogens are discussed below.

#### 7.3.1 Real-Time PCR

The real-time PCR technology provides escalating opportunities to identify phytopathogenic fungi and has been used in several studies for detection and identification of various *formae speciales* of *F. oxysporum* (Table 7.2). It can more accurately quantify the extent of pathogen biomass in the host tissue and, with multiplex formats, enables simultaneous detection of different pathogens (Lievens et al. 2003). The main advantage of real-time PCR assay over end-point quantitative PCR is that the amplification products can be monitored in real time as they are accumulated in the exponential phase (Schena et al. 2004), thus allowing precise measurement of fungal DNA content in the reaction.

**Table 7.2** Some examples of real time-PCR assays developed for detection and identification of *Fusarium oxysporum formae speciales*

<i>F. oxysporum forma specialis</i>	Host plant	Chemistry	References
<i>basilici</i>	<i>Ocimum basilicum</i>	Taqman	Pasquali et al. (2006)
<i>chrysanthemi</i>	<i>Argyranthemum frutescens</i>	Taqman	Pasquali et al. (2004)
<i>chrysanthemi</i>	<i>Chrysanthemum morifolium</i>	Taqman	Pasquali et al. (2004)
<i>cucumerinum</i>	<i>Cucumis sativus</i>	SYBR Green I	Lievens et al. (2007)
<i>radicis-cucumerinum</i>	<i>Cucumis sativus</i>	SYBR Green I	Lievens et al. (2007)
<i>tracheiphilum</i>	<i>Vigna unguiculata</i>	Taqman	Pasquali et al. (2004)
<i>tracheiphilum</i>	<i>Glycine max</i>	Taqman	Pasquali et al. (2004)
<i>vasinfectum</i>	<i>Gossypium</i> spp.	SYBR Green I	Abd-Elsalam et al. (2006)
<i>niveum</i>	<i>Citrullus lanatus</i>	SYBR Green I	Zhang et al. (2005)

Pasquali et al. (2004) developed a real-time PCR assay based on TaqMan chemistry to identify a new group of *F. oxysporum* f.sp. *chrysanthemi* isolates highly pathogenic on Paris daisy. They successfully identified infected plants using real-time PCR as early as the fifth day after artificial inoculation, although the plants remained symptomless until the 13th day after inoculation. Zhang et al. (2005) used real-time PCR to identify and quantify *F. oxysporum* f.sp. *niveum* and *Mycosphaerella melonis* pathogens directly from soil samples. Similarly, Abd-Elsalam et al. (2006) used real-time PCR based on the 16S and 23S rRNA genes to detect *F. oxysporum* f.sp. *vasinfectum* (Fov) in cotton. The assay detected as low as 200 fg of Fov genomic DNA in infected cotton roots, while no amplification was obtained from other plant structures such as stem and leaf. Lievens et al. (2007) developed a robust RAPD marker-based assay to specifically detect and identify the economically important cucumber pathogens *F. oxysporum* f.sp. *cucumerinum* and *F. oxysporum* f.sp. *radicis-cucumerinum*. They used the real-time PCR assay to confirm that the selected RAPD markers for *F. oxysporum* f.sp. *cucumerinum* and *F. oxysporum* f.sp. *radicis-cucumerinum* represented single copy DNA sequences. Likewise, Zambounis et al. (2007) developed two specific real-time PCR based assays based on the SNPs found in the 5' portion of the rDNA-IGS regions for quantification of genomic DNA of Australian isolates of *F. oxysporum* f.sp. *vasinfectum* from infected cotton tissues as well as soil samples.

However, like all other molecular methods based on DNA amplification, a major drawback of the system is that it is unable to distinguish between viable and dead propagules. Similarly, multiplexing in real-time PCR is limited by the number of different fluorescent dyes available. In addition, the initial and running costs of a real-time PCR system are several times more than a normal PCR system. However, considering the many benefits of the real-time PCR technology compared to normal PCR, the use of real-time PCR is still advantageous. Higgins et al. (2003) developed a portable real-time PCR instrument for performing diagnostic assays directly in the field. Such rapid real-time PCR diagnosis could result in taking appropriate and timely control measures than possible with traditional methods of pathogen

identification. Therefore, the resulting losses due to diseases as well as the cost of disease management could be greatly minimized.

### 7.3.2 Microarrays

Microarray holds promise for quick and accurate detection of plant pathogens. The potential of microarray technology in the detection and identification of plant pathogens is very high due to multiplex capabilities of the system. The application of microarrays for detection of pathogens in various environments has enabled parallel detection of multiple species in a high throughput format conducive to automation (Small et al. 2001; Loy et al. 2002). For pathogenic fungi, microarray analysis has a great potential to systematically and efficiently identify genes required for infection (Lorenz 2002; Bryant et al. 2004). A *Magnaporthe grisea* array is now commercially available from Agilent Technologies (<http://www.agilent.com/>).

A molecular detection system based on DNA array technology was developed by Lievens et al. (2003) for rapid and efficient detection of tomato vascular wilt pathogens *F. oxysporum* f.sp. *lycopersici*, *Verticillium albo-atrum*, and *V. dahliae*. The array was successfully used for sensitive detection of the tomato wilt pathogens from complex substrates like soil, plant tissues, and irrigation water as well as samples collected from tomato growers. Similarly, microarray analysis of *F. oxysporum* f.sp. *vasinfectum* genes expressed *in planta* (McFadden et al. 2006), has revealed pathogenic genes in the cotton pathogen. The expression of this gene was also positively correlated with vascular browning, which is a characteristic symptom of Fusarium wilt infection (McFadden et al. 2006). Guldener et al. (2006) reported the design and validation of the first Affymetrix GeneChip microarray based on the entire genome of *Fusarium graminearum*. It has been shown to efficiently detect genes from four other closely related species of *Fusarium graminearum*. As the genomes of some *formae speciales* of *F. oxysporum* have already been sequenced by the Broad Institute (<http://www.broad.mit.edu/>), microarray chips might become available for these and other *formae speciales* of *F. oxysporum* in the near future.

Generally, one needs to analyze conserved genes when taxonomically comparing phyla, orders, families, or genera. However, less conserved genes must be used when investigating species within a genus or taxonomic levels below the species (Lévesque 2001), such as *formae speciales* and races. Considering this, Lievens et al. (2007) developed a DNA array containing genus-, species- and *forma specialis*-specific detector oligonucleotides for the detection and identification of *F. oxysporum* f.sp. *cucumerinum* and *F. oxysporum* f.sp. *radicis-cucumerinum*. The array utilized the rRNA gene cluster to derive genus- and species-specific oligonucleotides, whereas RAPD-derived SCAR markers were used to specifically identify different *formae speciales*. Using such approach and taking into account the almost unlimited expanding possibilities of DNA arrays, a comprehensive DNA array for



the identification of all *formae speciales* (and possibly even races) of *F. oxysporum* may ultimately be realized (Lievens et al. 2008).

### 7.3.3 Gene/Genome Sequencing

One of the most robust and informative techniques useful in fungal diagnosis is nucleotide sequencing, where DNA sequence variations can be used to design species-specific primers and/or probes. Sequences of the *TEF-1a* and the mitochondrial small subunit (mtSSU) ribosomal RNA genes have been valuable in distinguishing different species (Baayen et al. 2000, 2001; O'Donnell et al. 2000; Skovgaard et al. 2001). Phylogenetic analysis of *TEF-1a* data by Gurjar et al. (2009) from four *F. oxysporum* f.sp. *ciceri* races revealed that race 3 of the pathogen was actually *Fusarium proliferatum* and not *F. oxysporum* as has been considered till now. Similarly, DNA sequences of UTP-ammonia ligase, trichothecene 3-O-acetyltransferase, a putative reductase (O'Donnell et al. 2000), nitrate reductase and phosphate permease (Skovgaard et al. 2001) have also been used successfully to distinguish different *Fusarium* species.

Elucidation of full sequence of the genome of an organism can help in designing the most accurate and sensitive method for its detection and identification. Based on genome analysis, new specific sequences could be used to design microarray chips, detection probes, or PCR primers for different pathogens. Using these, it is possible to identify not only the *formae speciales*, but also individual races of a pathogen. Genome sequencing efforts are currently in progress for several important species of the *Fusarium* genus (*F. circinatum*, *F. graminearum*, *F. oxysporum*, *F. proliferatum*, *F. sporotrichioides*, and *F. verticillioides*) (Table 7.3) and the genomes are available at Genomes OnLine Database (GOLD; <http://www.genomesonline.org/index2.htm>). In case of *F. oxysporum*, the genome of f.sp. *lycopersici* strain FGSC 4286 was sequenced at 6.8X coverage using the whole genome shotgun (WGS) sequencing method and the draft sequence is now available. Automated annotation of the draft sequence predicted over 17,000 protein-coding genes. Further analysis of these genes can elucidate host-pathogen interactions and allow the development of disease management approaches targeting important pathogenicity genes of the pathogens.

### 7.3.4 DNA Barcoding

DNA barcoding holds enormous potential for the rapid identification of organisms at the species level. It is a taxonomic method that uses a short genetic marker in an organism's DNA to identify it as belonging to a particular species. It is emerging as an important tool for the precise taxonomic identification of a wide range of species and is effective at both identifying existing species and discovering new ones.



**Table 7.3** Status of genome sequencing projects of various *Fusarium* species<sup>a</sup>

Fusarium species/ strains	Type	Genome size	Sequencing centers	Sequencing depth	Sequencing status
<i>F. circinatum</i> FSP 34	Genome	50 Mb	Inqaba Biotechnologies FABI	10x	Complete
<i>F. graminearum</i>	Genome	36 Mb	Cereal Disease Laboratory	N.A.	Incomplete
<i>F. graminearum</i>	Genome	36 Mb	Syngenta AG	N.A.	Incomplete
<i>F. graminearum</i> PH-1	Genome	36 Mb	Broad Institute IGGR	10x	Complete and Published
<i>F. oxysporum</i> f.sp. <i>lycopersici</i> FGSC 4286	Genome	17,000 ORFs	Broad Institute	6.8x	Incomplete
<i>F. proliferatum</i>	Genome	N.A.	Greenomics	N.A.	Incomplete
<i>F. sporotrichioides</i>	EST	N.A.	Univ of Oklahoma	N.A.	Incomplete
<i>F. verticillioides</i>	Genome	87 Mb	J. Craig Venter Institute USDA/ ARS	N.A.	Complete
<i>F. verticillioides</i> 7600	Genome	46 Mb	Broad Institute Syngenta	8x	Incomplete

<sup>a</sup>Status as of August 31, 2009; N.A.: Not available

A 648-bp region of the mitochondrial cytochrome c oxidase subunit I (COI) gene was initially proposed as a potential “DNA barcode” (Hebert et al. 2003). Using this new standard, databases are being developed to facilitate rapid and accurate identification of plant pathogens in general (Plant Pathogen Barcode, PPB; <http://www.plantpathogenbarcode.org/>) and fungi in particular (All Fungi Barcoding, <http://www.allfungi.com/>). Seifert et al. (2007) evaluated suitability of the COI gene in fungi by analyzing 370 strains from 58 species of *Penicillium* subgenus *Penicillium* and 12 allied species and found that the gene could be successfully used for fungal barcoding. Strains from 38 out of 58 species formed cohesive assemblages with distinct COI sequences, and all cases of sequence sharing involved known species complexes. However, there are reports that the COI gene does not work well for most true fungi and some researchers feel that the most appropriate gene for DNA barcoding of true fungi is the ITS region of the nuclear ribosomal DNA (<http://www.allfungi.com/>).

Although DNA barcoding holds great promise for species identification, its use in molecular phylogenetics is challenging. Hajibabaei et al. (2006) showed that phylogenetic trees constructed from short DNA barcodes, although approximately reflected accepted phylogenetic relationships, had low statistical support at many of the internal nodes and could seriously misrepresent some of the branching patterns. Hence, Min and Hickey (2007) assessed the effect of varying sequence length of DNA barcodes for the classification of unknown specimens at the species level as well as for phylogenetic reconstruction in fungi. They found that reducing the length of the barcode had a profound effect on the accuracy of resulting phylogenetic trees; however, the short barcode sequences still identified the fungal species accurately. They concluded that the standard short barcode sequences (~600 bp)

were suitable for species identification, but not for inferring accurate phylogenetic relationships among the fungi. Hence, it is possible that the standard DNA barcoding might accurately distinguish different *Fusarium* species; however, longer barcodes would be necessary to precisely identify different *formae speciales* and races of the *F. oxysporum* species complex.

## 7.4 Emerging Technologies for Pathogen Identification

### 7.4.1 Next-Generation Sequencing

The recently-developed “Next-Generation” sequencing platforms, such as 454 (Roche), Solexa (Illumina), and SOLiD (ABI), allow researchers to obtain several million bp of sequences affordably in a single run in an unbiased manner. Among these sequencing platforms, the 454 GS FLX instrument currently has the ability to sequence 400–600 million bp per run (with 400–500 bp individual reads) using the Titanium series reagents (<http://www.454.com/>). Due to its high accuracy, low cost, and long reads compared to the Solexa and SOLiD systems, many researchers have migrated toward the 454 sequencing platform for a variety of genome projects. As these instruments have the potential of sequencing several microbial genomes in a single run, it is very likely that the genomes of economically important plant pathogens, including various *Fusarium* species, will be shortly available. Indeed, genome sequencing projects of several *Fusarium* species are already in progress (Table 7.3). Based on the analysis of these genomes, specific oligonucleotide sequences could be used to design microarray chips, detection probes, or PCR primers for high-throughput or multiplexed detection and identification of different *F. oxysporum* strains. If the genomes of important *F. oxysporum formae speciales*, and individual races become available, the pathogenic isolates could be detected specifically even if camouflaged by other organisms.

### 7.4.2 Single-Nucleotide Polymorphisms

Detection and characterization of SNPs is also one of the promising post-genomics research tools for pathogen identification. This new technology is pushing pathogen identification to its ultimate limit—the single base pair difference. It is presumed that many plant pathogenic races or *formae speciales* differ from their closest relatives by only a few bases in different genes. The next-generation sequencing platforms can rapidly carry out deep sequencing of microbial genomes, enabling quick discovery of SNPs in different pathogenic strains of the microbial species. This will enable designing *forma specialis* or race-specific cleaved amplified polymorphic sequence (CAPS) or derived cleaved amplified polymorphic sequence (dCAPS)

markers for PCR-based identification. CAPS markers result from differential restriction digestion of gene/allele specific PCR products based on the loss or gain of restriction enzyme recognition sites due to the presence of SNPs or insertion/deletion mutations. While in dCAPS analysis, a restriction enzyme recognition site that includes the SNP is introduced into the PCR product by a primer containing one or more mismatches to template DNA (Neff et al. 1998). Zambounis et al. (2007) discovered SNPs in a portion of the IGS region of rDNA flanking the 5' end and developed specific real-time PCR-based assays for absolute quantification of genomic DNA from the Australian *Fusarium oxysporum* f.sp. *vasinfectum* isolates obtained from infected cotton tissues as well as soil samples.

### 7.4.3 Metagenomics

Another promising approach to large scale detection of microbes from diverse samples is metagenomics. It is the study of genomic content of microbial organisms directly in their natural environments, bypassing the need for isolation and culturing of individual species (Chen and Pachter 2005). Hence, metagenomics enables studies of organisms that are not culturable as well as studies of organisms in their natural environment. Using the metagenomics approach, these new sequencing technologies enable researchers to quickly and affordably identify the organisms present in a complex sample (such as soil, irrigation water, or plant tissues) without any prior knowledge. Such metagenomics approach to pathogen identification should facilitate quick identification and quantification of a range of pathogens present in the sample and enable undertaking appropriate disease control strategies well before the pathogen populations reach damage thresholds. The 454 GS FLX System is very suitable for metagenomics as the system's long reads help in accurate identification of pathogenic strains present in the sample. Researchers often use the platform for counting gene tags to analyze the relative abundance of different microbial species in different samples.

## 7.5 Potential Limitations of Molecular Identification Techniques

Currently, PCR, real-time PCR, and microarrays are the methods of choice for rapid and accurate detection of plant pathogens. However, a major problem of PCR based detection is that PCR could amplify DNA from both active and non-active or dead pathogen cells/spores. Therefore, it may yield false positive results in some cases. Similarly, false negatives can be attributed in standard PCR protocols due to the presence of compounds that inhibit the polymerases, degradation of the target DNA sequence, or reagent problems (Louws et al. 1999). Likewise, although microarray

is the most suitable technique for multiplexed detection of many isolates of *F. oxysporum* and other pathogens in a single assay, currently microarrays are expensive for routine application. Moreover, additional work is needed to address the challenges of working with environmental samples where contaminants may interfere with DNA hybridization and affect the performance of microarrays. Similarly, the lack of adequate sequence information can hamper the development of reliable molecular diagnostic assays. Moreover, techniques like DNA barcoding are presently unable to differentiate pathogenic strains from non-pathogenic ones that belong to the same microbial species. Hence, if no molecular markers are available to distinguish the pathogenic subspecies, pathogenicity test is the only way to determine whether or not a given isolate is pathogenic on a specific crop or variety.

Although technically feasible and potentially invaluable, large sequencing studies still face significant challenges. Foremost among the challenges is analyzing the tremendous amounts of data generated (Nelson 2003). It is relatively easy to characterize genes and genome of a well-studied and easily cultivated microbe; however, it would be a daunting task to understand the genomics of unknown or uncultured microbes or whole environmental genomes revealed by metagenomics approaches. For example, Tringe et al. (2005) could assemble as many as 150,000 sequence reads into contiguous sequences spanning only 1% of a soil metagenome. They estimated that 2–5 billion bp of sequence would be needed to completely cover the metagenome of a Minnesota soil. Similarly, in mixed microbial communities like agricultural soils, it will be difficult to separate, assemble, and annotate the genomes of a range of soil microflora. In addition, incorrect assembly of contiguous genomes and the formation of chimeric inserts can create problems in interpreting the data (Schloss and Handelsman 2005).

## 7.6 Conclusions and Future Prospects

Genomics research is generating fast-growing databases that can be used to design molecular assays for simultaneous detection of a large number of pathogens, coupled with novel platforms having unprecedented capabilities for multiplexing, high throughput, and portability. As these new technologies gain wide acceptance, routine detection, identification, and monitoring of plant pathogens should become more common in plant pathology. Microarray chips are now being fabricated with oligonucleotides that are either synthesized directly on a solid surface or are microspotted. Similarly, the next generation sequencing technologies like 454 and SOLiD can sequence several microbial genomes in a single run.

If the complete DNA sequence of plant pathogens is revealed, oligonucleotides specific for a pathogen can be designed and a single high-density microarray chip could accommodate oligonucleotides specific to a large number of pathogens. In the next few years, complete genome sequences of many pathogenic strains of *F. oxysporum* are likely to become available and these will help to design

PCR primers or probes very specific to the pathogen strains, enabling accurate identification of the strains even if camouflaged by other pathogens. For example, if each microarray chip contained oligonucleotides specific to each of the known *formae speciales* and races of *F. oxysporum*, it would be possible to have multiplex detection of all these pathogens in one experiment even from complex substrates like soil, plant tissues, and irrigation water. With such high-throughput technologies, integration of more strains into the detection systems of *F. oxysporum* should become possible and identification of pathogens is likely to become an easier task. However, these should be observed as management tools, to be used in combination with the knowledge of the crop and understanding of the biology of different *formae speciales* and ecology of the diseases. In this respect, the increasing availability of full-genome sequences of many plant pathogens including *formae speciales* of *F. oxysporum* is a welcome development.

With the availability of affordable and portable real-time PCR instruments (Higgins et al. 2003) and simpler protocols, molecular-based diagnosis of crop diseases is becoming a field reality. Routine diagnosis of many crop diseases is now possible in one day or less using recent innovative technologies. This, coupled with high throughput that reduces the cost per sample, should make these assays more attractive for use in crop protection. A combination of DNA microarrays with other genomic methods will certainly accelerate the efforts to characterize the function of unknown stretches of fungal genomes. The resulting database will allow complete analysis of developmental processes that are characteristics of the fungus, including the molecular nature of pathogenicity. However, new molecular detection technologies that are portable, robust, sensitive, and cost effective need to be developed for routine identification of plant pathogens directly in the field to undertake appropriate disease control measures as quickly as possible.

## References

- Abd-Elsalam KA (2003) Non-gel based techniques for plant pathogen genotyping. *Acta Microbiol Polon* 52:329–341
- Abd-Elsalam KA, Khalil MS, Aly AA, Asran-Amal A (2002a) Genetic diversity among *Fusarium oxysporum* f.sp. *vasinfectum* isolates revealed by UP-PCR and AFLP markers. *Phytopathologia Medit* 41:1–7
- Abd-Elsalam KA, Khalil MS, Aly AA, Asran-Amal A (2002b) Population analysis of *Fusarium* spp. *Phytomedizin* 3:18–19
- Abd-Elsalam KA, Omar MR, Migheli Q, Nirenberg HI (2004) Genetic characterization of *Fusarium oxysporum* f.sp. *vasinfectum* isolates by random amplification of polymorphic DNA (RAPD) and amplified fragment length polymorphism (AFLP). *J Plant Dis Protect* 111:534–544
- Abd-Elsalam KA, Asran-Amal A, Schnieder F, Migheli Q, Verreet JA (2006) Molecular detection of *Fusarium oxysporum* f.sp. *vasinfectum* in cotton roots by PCR and real-time PCR assay. *J Plant Dis Protect* 113:14–19
- Abdel-Satar MA, Khalil MS, Mohamed IN, Abd-Elsalam KA, Verreet JA (2003) Molecular phylogeny of *Fusarium* species by AFLP fingerprint. *Afr J Biotechnol* 2:51–55

- Abo K, Klein KK, Edel-Hermann V, Gautheron N, Traore D, Steinberg C (2005) High genetic diversity among strains of *Fusarium oxysporum* f.sp. *vasinfectum* from cotton in Ivory Coast. *Phytopathology* 95:1391–1396
- Alves-Santos FM, Benito EP, Eslava AP, Diaz-Minguez JM (1999) Genetic diversity of *Fusarium oxysporum* strains from common bean fields in Spain. *Appl Environ Microbiol* 65:3335–3340
- Alves-Santos FM, García-Sánchez RB, MA EAP, Díaz-Minguez JM (2002) A DNA-based procedure for in planta detection of *Fusarium oxysporum* f.sp. *phaseoli*. *Phytopathology* 92:237–244
- Appel DJ, Gordon TR (1995) Intraspecific variation within populations of *Fusarium oxysporum* based on RFLP analysis of the intergenic spacer region of the rDNA. *Exp Mycol* 19:120–128
- Armstrong GM, Armstrong JK (1981) *Formae specialis* and races of *Fusarium oxysporum* causing wilt diseases. *Fusarium: diseases, biology and taxonomy*. Pennsylvania State University Press, University Park (US), pp 391–399
- Assigbetse KB, Fernandez D, Dubois MP, Geiger JP (1994) Differentiation of *Fusarium oxysporum* f.sp. *vasinfectum* races on cotton by random amplified polymorphic DNA (RAPD) analysis. *Phytopathology* 84:622–626
- Attitalla IH, Fatehi J, Levenfors J, Brishammar S (2004) A rapid molecular method for differentiating two special forms (*lycopersici* and *radicis-lycopersici*) of *Fusarium oxysporum*. *Mycol Res* 108:787–794
- Baayen RP, van Dreven F, Krijger MC, Waalwijk C (1997) Genetic diversity in *Fusarium oxysporum* f.sp. *dianthi* and *Fusarium redolens* f.sp. *dianthi*. *Eur J Plant Pathol* 103:395–408
- Baayen RP, Forch MG, Waalwijk C, Bonants PJM, Loffler HJM, Roebroek EJA (1998) Pathogenic, genetic, and molecular characterization of *Fusarium oxysporum* f.sp. *lilii*. *Eur J Plant Pathol* 104:887–894
- Baayen RP, O'Donnell K, Bonants PJM, Cigelnik E, Kroon LPNM, Roebroek EJA, Waalwijk C (2000) Gene genealogies and AFLP analyses within the *Fusarium oxysporum* complex identify monophyletic and non-monophyletic *Formae specialis* causing wilt and rot disease. *Phytopathology* 90:891–900
- Baayen RP, O'Donnell K, Breeuwsma S, Geiser DM, Waalwijk C (2001) Molecular relationships of fungi within the *Fusarium redolens*-*F. hostae* clade. *Phytopathology* 91:1037–1044
- Bao JR, Favel DR, O'Neill NR, Lazarovits G, van Berkum P (2002) Genetic analysis of pathogenic and non-pathogenic *Fusarium oxysporum* from tomato plant. *Can J Bot* 80: 271–279
- Barve MP, Haware MP, Sainani MN, Ranjekar PK, Gupta VS (2001) Potential of microsatellites to distinguish four races of *Fusarium oxysporum* f.sp. *ciceri* prevalent in India. *Theor Appl Genet* 102:138–147
- Bateman GL, Kwasna H, Ward E (1996) Relationship among *Fusarium* spp estimated by comparing restriction fragment length polymorphisms in polymerase chain reaction-amplified nuclear rDNA. *Can J Microbiol* 42:1232–1240
- Bayraktar H, Dolar FS, Maden S (2008) Use of RAPD and ISSR markers in detection of genetic variation and population structure among *Fusarium oxysporum* f.sp. *ciceris* isolates on chickpea in Turkey. *J Phytopathol* 156:146–154
- Beckman CH, Roberts EM (1995) On the nature and genetic basis for resistance and tolerance to wilt diseases of plants. *Adv Bot Res* 21:35–77
- Bentley S, Pegg KG, Dale JL (1994) Optimization of RAPD-fingerprinting 1 to analyze genetic variation within populations of *Fusarium oxysporum* f.sp. *cubense*. *J Phytopathol* 142:64–78
- Bentley S, Pegg KG, Dale JL (1995) Genetic variation among a world-wide collection of isolates of *Fusarium oxysporum* f.sp. *cubense* analyzed by RAPD-PCR fingerprinting. *Mycol Res* 11:1378–1384
- Bodker L, Lewis BG, Coddington A (1993) The occurrence of a new genetic variant of *Fusarium oxysporum* f.sp. *pisi*. *Plant Pathol* 42:833–838

- Boehm EWA, Ploetz RC, Kistler HC (1994) Statistical analysis of electrophoretic karyotype variation among vegetative compatibility groups of *Fusarium oxysporum* f.sp. *cubense*. Mol Plant Microbe Interact 7:196–207
- Bogale M, Wingfield BD, Wingfield MJ, Steenkamp ET (2005) Simple sequence repeat markers for species in the *Fusarium oxysporum* complex. Mol Ecol Notes 5:622–624
- Bogale M, Wingfield BD, Wingfield MJ, Steenkamp ET (2006) Characterization of *Fusarium oxysporum* isolates from Ethiopia using AFLP, SSR and DNA sequence analyses. Fungal Div 23:51–66
- Bogale M, Wingfield BD, Wingfield MJ, Steenkamp ET (2007) Species-specific primers for *Fusarium redolens* and a PCR-RFLP technique to distinguish among three clades of *Fusarium oxysporum*. FEMS Microbiol Lett 271:27–32
- Bosland PW, Williams PH (1987) An evaluation of *Fusarium oxysporum* from crucifers based on pathogenicity, isozyme polymorphism, vegetative compatibility, and geographic origin. Can J Bot 65:2067–2073
- Bryant P, Venter A, Robins-Browne D, Curtis R (2004) Chips with everything: DNA microarrays in infectious diseases. Lancet Infect Dis 4:100–111
- Burgess LW (1981) General ecology of the Fusaria. In: Nelson PE, Toussoun TA, Cook RJ (eds) *Fusarium: diseases, biology and taxonomy*. Pennsylvania State University Press, University Park, Pennsylvania, USA, pp 225–235
- Chen K, Pachter L (2005) Bioinformatics for whole-genome shotgun sequencing of microbial communities. PLoS Comp Biol 1:24
- Chiocchetti A (2001) PCR Detection of *Fusarium oxysporum* f. sp. *basilici* on Basil. Plant Dis 85:607–611
- Chiocchetti A, Ghignone S, Minuto A, Gullino ML, Garibaldi A, Migheli Q (1999) Identification of *Fusarium oxysporum* f.sp. *basilici* isolated from soil, basil seed, and plants by RAPD analysis. Plant Dis 83:576–581
- Cramer RA, Byrne PF, Brick MA, Panella L, Wickliffe E, Schwartz HF (2003) Characterization of *Fusarium oxysporum* isolates from common bean and sugar beet using pathogenicity assays and random amplified polymorphic DNA markers. J Phytopathol 151:352–360
- de Haan LAM, Numansen A, Roebroek EJA, van Doorn J (2000) PCR detection of *Fusarium oxysporum* f.sp. *gladioli* race 1, causal agent of Gladiolus yellows disease, from infected corms. Plant Pathol 49:89–100
- Demeke T, Clear RM, Patrick SK, Gaba D (2005) Species-specific PCR based assays for the detection of *Fusarium* species and a comparison with the whole seed agar plate method and trichothecene analysis. Intl J Food Microbiol 103:271–284
- DeScenzo RA, Engel SR, Gomez G, Jackson EL, Munkvold GP, Weller J, Irelan NA (1999) Genetic analysis of *Eutypa* strains from California supports the presence of two pathogenic species. Phytopathology 89:884–893
- Edel V, Steinberg C, Gautheron N, Alabouvette C (1997) Evaluation of restriction analysis of polymerase chain reaction (PCR)- amplified ribosomal DNA for the identification of *Fusarium* species. Mycol Res 101:179–187
- Edel V, Steinberg C, Gautheron N, Alabouvette C (2000) Ribosomal DNA-targeted oligonucleotide probe and PCR assay specific for *Fusarium oxysporum*. Mycol Res 104:518–526
- Edwards SG, O'callaghan J, Dobson ADW (2002) PCR-based detection and quantification of mycotoxigenic fungi. Mycol Res 106:1005–1025
- Elias KS, Schneider RW (1991) Vegetative compatibility groups in *Fusarium oxysporum* f.sp. *lycopersici*. Phytopathology 81:159–162
- Elias KS, Schneider RW (1992) Genetic diversity within and among races and vegetative compatibility groups of *Fusarium oxysporum* f.sp. *lycopersici* as determined by isozyme analysis. Phytopathology 82:1421–1427
- Elias KS, Zamir D, Lichtman-Pleban T, Katan T (1993) Population: structure of *Fusarium oxysporum* f.sp. *lycopersici*: restriction fragment length polymorphisms provide genetic evidence that vegetative compatibility group is an indicator of evolutionary origin. Mol Plant Microbe Interact 6:565–572

- Elnifro EM, Ashshi AM, Cooper RJ, Klapper PE (2000) Multiplex PCR: optimization and application in diagnostic virology. *Clin Microbiol Rev* 13:559–570
- Fernandez D, Tantaoui A (1994) Random amplified polymorphic DNA (RAPD) analysis: a tool for rapid characterization of *Fusarium oxysporum* f.sp. *albedinis* isolates. *Phytopathol Mediterr* 33:223–229
- Fernandez D, Assigbetse KB, Dubois MP, Geiger JP (1994) Molecular characterization of races and vegetative compatibility groups in *Fusarium oxysporum* f.sp. *vasinfectum*. *Appl Environ Microbiol* 60:4039–4046
- Fernandez D, Ouinten M, Tantaoui A, Lourd M, Geiger JP (1995) Population genetic structure of *Fusarium oxysporum* f.sp. *albedinis* (Abstr). *Fungal Genet Newsl* 42A:34
- Fernandez D, Ouinten M, Tantaoui A, Geiger JP, Daboussi MJ, Langin T (1998) Fot1 insertions in the *Fusarium oxysporum* f. sp. *albedinis* genome provide diagnostic PCR targets for detection of the date palm pathogen. *Appl Environ Microbiol* 64:633–636
- Flood J, Whitehead DS, Cooper RM (1992) Vegetative compatibility and DNA polymorphisms in *Fusarium oxysporum* f.sp. *elaeidis* and their relationship to isolate virulence and origin. *Physiol Mol Plant Pathol* 41:201–215
- Garcia-Mas J, Oliver M, G'omez-Paniagua H, de Vicente MC (2000) Comparing AFLP, RAPD and AFLP markers for measuring genetic diversity in melon. *Theor Appl Genet* 101:860–864
- Gerlach KS, Bentley S, Moore NY, Pegg KG, Aitken AB (2000) Characterisation of Australian isolates of *Fusarium oxysporum* f.sp. *cubense* by DNA fingerprinting analysis. *Aus J Agri Res* 51:945–953
- Gonzalez M, Rodriguez MEZ, Jacabo JL, Hernandez F, Acosta J, Martinez O, Simpson J (1998) Characterization of Mexican isolates of *Colletotrichum lindemuthianum* by using differential cultivars and molecular markers. *Phytopathology* 88:292–299
- Grajal-Martin MJ, Simon CJ, Muehlbauer FJ (1993) Use of random amplified polymorphic DNA (RAPD) to characterize race 2 of *Fusarium oxysporum* f.sp. *pisi*. *Phytopathology* 83:612–614
- Groenewald S, Berg NVD, Marasas WFO, Viljoen A (2006) The application of high-throughput AFLP's in assessing genetic diversity in *Fusarium oxysporum* f.sp. *cubense*. *Mycol Res* 110:297–305
- Guldener U, Seong KU, Boddu J, Cho S, Trail F, Xu JR, Adam G, Mewes HW, Muehlbauer FJ, Kistler HC (2006) Development of a *Fusarium graminearum* Affymetrix GeneChip for profiling fungal gene expression *in vitro* and in planta. *Fungal Gen Biol* 43:316–325
- Gurjar G, Barve M, Giri A, Gupta V (2009) Identification of Indian pathogenic races of *Fusarium oxysporum* f.sp. *ciceris* with gene specific, ITS and random markers. *Mycologia* 101:480–491
- Hajibabaei M, Janzen DH, Burns JM, Hallwachs W, Hebert PDN (2006) DNA barcodes distinguish species of tropical Lepidoptera. *Proc Natl Acad Sci USA* 103:968–971
- Hamelin RC, Berube P, Gignac M, Bourassa M (1996) Identification of root rot fungi in nursery seedlings by nested multiplex PCR. *Appl Environ Microbiol* 62:4026–4031
- Hebert PDN, Cywinska A, Ball SL, de Waard JR (2003) Biological identifications through DNA barcodes. *Proc R Soc Lond B Biol Sci* 270:313–322
- Higgins JA, Nasarabadi S, Karns JS, Shelton DR, Cooper M, Gbakima A, Koopman RP (2003) A handheld real time thermal cyclers for bacterial pathogen detection. *Biosens Bioelectr* 18: 1115–1123
- Hirano Y, Arie T (2006) PCR-based differentiation of *Fusarium oxysporum* f.sp. *lycopersici* and *radicis-lycopersici* and races of *F oxysporum* f.sp. *lycopersici*. *J Genet Plant Pathol* 72: 273–283
- Hirota N, Hashiba T, Yoshida H, Kikumoto T, Ehara Y (1992) Detection and properties of plasmid-like DNA in isolates from twentythree *formae specialis* of *Fusarium oxysporum*. *Ann Phytopathol Soc Jpn* 58:386–392
- Honnareddy N, Dubey SC (2006) Pathogenic and molecular characterization of Indian isolates of *Fusarium oxysporum* f.sp. *ciceris* causing chickpea wilt. *Curr Sci* 91:661–666
- Jacobson DJ, Gordon TR (1990) Variability of mitochondrial DNA as an indicator of relationships between populations of *Fusarium oxysporum* f. sp. *melonis*. *Mycol Res* 94:734–744



- Jimenez-Gasco MM, Jimenez-Diaz RM (2003) Development of a specific polymerase chain reaction-based assay for the identification of *Fusarium oxysporum* f.sp. *ciceris* and its pathogenic races 0, IA, 5, and 6. *Phytopathology* 93:200–209
- Jimenez-Gasco MD, Perz-Artes E, Jimenez-Diaz RM (2001) Identification of pathogenic races 0, 1B/C, 5, and 6 of *Fusarium oxysporum* f.sp. *ciceris* with random amplified polymorphic DNA (RAPD). *Eur J Plant Pathol* 107:237–248
- Katan T (1999) Current status of vegetative compatibility groups in *Fusarium oxysporum*. *Phytoparasitica* 27:51–64
- Katan T, Di Primo P (1999) Current status of vegetative compatibility groups in *Fusarium oxysporum*. *Phytoparasitica* 27:273–277
- Katan T, Zamir D, Sarfatti M, Katan J (1991) Vegetative compatibility groups and subgroups in *Fusarium oxysporum* f.sp. *radicis-lycopersici*. *Phytopathology* 81:255–262
- Kelly A, Alcalá-Jimenez AR, Bainbridge BW, Heale JB, Perez-Artes E, Jimenez-Diaz RM (1994) Use of genetic fingerprinting and random amplified polymorphic DNA to characterize pathotypes of *Fusarium oxysporum* f.sp. *ciceris* infecting chickpea. *Phytopathology* 84:1293–1298
- Kelly AG, Bainbridge BW, Heale JB, Perez-Artes E, Jimenez-Diaz RM (1998) In planta-polymerase-chain-reaction detection of the wilt-inducing pathotype of *Fusarium oxysporum* f.sp. *ciceris* in chickpea (*Cicer arietinum* L.). *Physiol Mol Plant Pathol* 52:397–409
- Kim DH, Martyn RD, Magill CW (1993) Chromosomal polymorphism in *Fusarium oxysporum* f.sp. *niveum*. *Phytopathology* 83:1209–1216
- Kiprop EK, Baudoin JP, Mwang'ombe AN, Kimani PM, Mergeai G, Maquet A (2002) Characterization of Kenyan isolates of *Fusarium udum* from pigeonpea [*Cajanus cajan* (L) Mill sp] by cultural characteristics, aggressiveness and AFLP analysis. *J Phytopathol* 150:517–527
- Kistler HC (1997) Genetic diversity in the plant-pathogenic fungus *Fusarium oxysporum*. *Phytopathology* 87:474–479
- Kistler HC, Benny U (1989) The mitochondrial genome of *Fusarium oxysporum*. *Plasmid* 22:86–89
- Kistler HC, Bosland PW, Benny U, Leong S, Williams PH (1987) Relatedness of strains of *Fusarium oxysporum* from crucifers measured by examination of mitochondrial and ribosomal DNA. *Phytopathology* 77:1289–1293
- Kistler HC, Momol EA, Benny U (1991) Repetitive genomic sequences for determining relatedness among strains of *Fusarium oxysporum*. *Phytopathology* 81:331–336
- Koenig RL, Kistler HC, Ploetz RC (1993) Restriction fragment length polymorphism analysis of *Fusarium oxysporum* f.sp. *cubense*. In: 6th Int Congr Plant Pathol. National Research Council of Canada, Ottawa, pp 158
- Latiffah Z, Nur-Hayati MZ, Baharuddin S, Maziah Z (2009) Identification and Pathogenicity of *Fusarium* species associated with root rot and stem rot of *Dendrobium*. *Asian J Plant Pathol* 3:14–21
- Leslie JF, Zeller KA, Lamprecht SC, Rheeder JP, Marasas WFO (2005) Toxicity, pathogenicity, and genetic differentiation of five species of *Fusarium* from sorghum and millet. *Phytopathology* 95:275–283
- Lévesque CA (2001) Molecular methods for detection of plant pathogens – what is the future. *Can J Plant Pathol* 24:333–336
- Lievens B, Brouwer M, Vanachter ACRC, Lévesque CA, Cammue BPA, Thomma BPHJ (2003) Design and development of a DNA array for rapid detection and identification of multiple tomato vascular wilt pathogens. *FEMS Microbiol Lett* 223:113–122
- Lievens B, Claes L, Vakalounakis DJ, Vanachter ACRC, Thomma BPHJ (2007) A robust identification and detection assay to discriminate the cucumber pathogens *Fusarium oxysporum* f.sp. *cucumerinum* and f.sp. *radicis-cucumerinum*. *Environ Microbiol* 9:2145–2161
- Lievens B, Rep M, Thomma BPHJ (2008) Recent developments in the molecular discrimination of *formae speciales* of *Fusarium oxysporum*. *Pest Manag Sci* 64:781–788
- Lopez MM, Bertolini E, Olmos A, Caruso P, Gorris MT, Llop P, Penyalver R, Cambra M (2003) Innovative tools for detection of plant pathogenic viruses and bacteria. *Int Microbiol* 6: 233–243

- Lorenz MC (2002) Genomic approaches to fungal pathogenicity. *Curr Opin Microbiol* 5:372–378
- Louws FJ, Rademaker JLW, Brujin FJ (1999) The three Ds of PCR-based genomic analysis of phyto-bacteria: diversity, detection, and disease diagnosis. *Ann Rev Phytopathol* 37:81–125
- Loy A, Lehner A, Lee N, Adamczyk J, Meier H, Ernst J, Schleifer K, Wagner M (2002) Oligonucleotide arrays for 16S rRNA genebased detection of all recognized lineages of sulfate-reducing Prokaryotes in the environment. *Appl Environ Microbiol* 68:5064–5081
- Majer D, Mithen R, Lewis B, Vos P, Oliver RP (1996) The use of AFLP fingerprinting for the detection of genetic variation in fungi. *Mycol Res* 100:1107–1111
- Malorny B, Tassios PT, Radstrom P, Cook N, Wagner M, Hoorfar J (2003) Standardization of diagnostic PCR for the detection of foodborne pathogens. *Intl J Food Microbiol* 83:39–48
- Manicom BQ, Baayen RP (1993) Restriction fragment length polymorphisms in *Fusarium oxysporum* f.sp. *dianthi* and other fusaria from *Dianthus* species. *Plant Pathol* 42:851–857
- Manicom BQ, Bar-Joseph M, Kotze JM, Becker MM (1990) A restriction fragment length polymorphism probe relating vegetative compatibility groups and pathogenicity in *Fusarium oxysporum* f.sp. *dianthi*. *Phytopathology* 80:336–339
- Manulis S, Kogan N, Reuven M, Ben-Yephet Y (1994) Use of the RAPD technique for identification of *Fusarium oxysporum* f.sp. *dianthi* from carnation. *Phytopathology* 84:98–101
- McFadden HG, Wilson IW, Chapple RM, Dowd C (2006) *Fusarium* wilt (*Fusarium oxysporum* f.sp. *vasinfectum*) genes expressed during infection of cotton (*Gossypium hirsutum*). *Mol Plant Pathol* 7:87–101
- Mes JJ, van Doorn J, Roebroek EJA, van Egmond E, van Aartrijk J, Boonekamp PM (1994) Restriction fragment length polymorphisms, races and vegetative compatibility groups within a worldwide collection of *Fusarium oxysporum* f.sp. *gladioli*. *Plant Pathol* 43:362–370
- Mes JJ, Weststeijn EA, Herlaar F, Lambalk JJM, Wijbrandi J, Haring MA, Cornelissen BJC (1999) Biological and molecular characterization of *Fusarium oxysporum* f.sp. *lycopersici* divides race I isolates into separate virulence groups. *Phytopathology* 89:156–160
- Miao VPW (1990) Using karyotype variability to investigate the origins and relatedness of isolates of *Fusarium oxysporum* f.sp. *cubense*. In: Ploetz RC (ed) *Fusarium* wilt of banana. The American Phytopathological Society, St Paul, MN, pp 55–62
- Min XJ, Hickey DA (2007) Assessing the effect of varying sequence length on DNA barcoding of fungi. *Mol Ecol Notes* 7:365–373
- Mishra PK, Fox RTV, Culham A (2003) Development of a PCR-based assay for rapid and reliable identification of pathogenic Fusaria. *FEMS Microbiol Lett* 218:329–332
- Mouyna I, Renard JL, Brygoo Y (1996) DNA polymorphism among *Fusarium oxysporum* f.sp. *elaedis* populations from oil palm, using a repeated and dispersed sequence “Palm”. *Curr Genet* 30:174–180
- Mule G, Susca A, Stea G, Moretti A (2004) Specific detection of the toxigenic species *Fusarium proliferatum* and *F. oxysporum* from asparagus plants using primers based on calmodulin gene sequences. *FEMS Microbiol Lett* 230:235–240
- Namiki F, Shiomi T, Kayamura T, Tsuge T (1994) Characterization of the *formae specialis* of *Fusarium oxysporum* causing wilts of cucurbits by DNA fingerprinting with nuclear repetitive DNA sequences. *Appl Environ Microbiol* 60:2684–2691
- Neff M, Neff J, Chory J, Pepper A (1998) dCAPS, a simple technique for the genetic analysis of single nucleotide polymorphisms: experimental applications in *Arabidopsis thaliana* genetics. *Plant J* 14:387–392
- Nelson KE (2003) The future of microbial genomics. *Environ Microbiol* 5:1223–1225
- Nicholson P, Simpson DR, Weston G, Rezanoor HN, Lees AK, Parry DW, Joyce D (1998) Detection and quantification of *Fusarium culmorum* and *Fusarium graminearum* in cereals using PCR assays. *Physiol Mol Plant Pathol* 53:17–37
- O’Donnell K, Kistler HC, Cigelnik E, Ploetz RC (1998) Multiple evolutionary origins of the fungus causing Panama disease of banana: concordant evidence from nuclear and mitochondrial gene genealogies. *Proc Natl Acad Sci USA* 95:2044–2049

- O'Donnell K, Kistler HC, Tacke BK, Casper HH (2000) Gene genealogies reveal global phylogeographic structure and reproductive isolation among lineages of *Fusarium graminearum*, the fungus causing wheat scab. *Proc Natl Acad Sci USA* 97:7905–7910
- Paavananen-Huhtala S, Hyvonen J, Bulat SA, Yli-Mattila T (1999) RAPD-PCR, isozyme, rDNA RFLP and rDNA sequence analyses in identification of Finnish *Fusarium oxysporum* isolates. *Mycol Res* 103:625–634
- Pasquali M, Marena L, Fiora E, Piatti P, Gullino ML, Garibaldi A (2004) Real-time PCR for the identification of a highly pathogenic group of *Fusarium oxysporum* f.sp. *chrysanthemi* on *Argyranthemum frutescens* L. *J Plant Pathol* 86:51–57
- Pasquali M, Piatti P, Gullino ML, Garibaldi A (2006) Development of a real-time polymerase chain reaction for the detection of *Fusarium oxysporum* f.sp. *basilici* from basil seed and roots. *J Phytopathol* 154:632–636
- Pasquali M, Dematheis F, Gullino ML, Garibaldi A (2007) Identification of race 1 of *Fusarium oxysporum* f.sp. *lactucae* on lettuce by inter-retrotransposon sequence-characterized amplified region technique. *Phytopathology* 97:987–996
- Perez-Artes E, Roncero MIG, Diaz RMJ (1995) Restriction fragment length polymorphism analysis of the mitochondrial DNA of *Fusarium oxysporum* f.sp. *ciceri*. *J Phytopathol* 143:105–109
- Ploetz RC (1990) Variability in *Fusarium oxysporum* f.sp. *cubense*. *Can J Bot* 68:1357–1363
- Puhalla JE (1985) Classification of strains of *Fusarium oxysporum* on the basis of vegetative compatibility. *Can J Bot* 63:179–183
- Purwantara A, Barrins JM, Cozijnsen AJ, Ades PK, Howlet BJ (2000) Genetic diversity of the *Leptosphaeria maculans* species complex from Australia, Europe and North America using amplified fragment length polymorphism analysis. *Mycol Res* 104:772–781
- Schena L, Franco N, Ippolito A, Gallitelli D (2004) Real-time quantitative PCR: a new technology to detect and study phytopathogenic and antagonistic fungi. *Eur J Plant Pathol* 110:893–908
- Schilling AG, Möller EM, Geiger HH (1996) Polymerase chain reaction-based assays for species-specific detection of *Fusarium culmorum*, *F. graminearum*, and *F. avenaceum*. *Phytopathology* 86:515–522
- Schloss PD, Handelsman J (2005) Metagenomics for studying unculturable micro-organisms: cutting the Gordian knot. *Genome Biol* 6:229
- Seifert KA, Samson RA, Dewaard JR, Houbraken J, Levesque CA, Moncalvo JM, Louis-Seize G, Hebert PD (2007) Prospects for fungus identification using CO1 DNA barcodes, with *Penicillium* as a test case. *Proc Natl Acad Sci USA* 104:3901–3906
- Shimazu J, Yamauchi N, Hibi T, Satou M, Horiuchi S, Shirakawa T (2005) Development of sequence tagged site markers to identify races of *Fusarium oxysporum* f.sp. *lactucae*. *J Gen Plant Pathol* 71:183–189
- Singh BP, Saikia R, Yadav M, Singh R, Chauhan VS, Arora DK (2006) Molecular characterization of *Fusarium oxysporum* f.sp. *ciceri* causing wilt of chickpea. *Afr J Biotechnol* 5:497–502
- Sivaramakrishnan S, Kannan S, Singh SD (2002) Genetic variability of fusarium wilt pathogen isolates of chickpea (*Cicer arietinum* L) assessed by molecular markers. *Mycopathologia* 155:171–178
- Skovgaard K, Nirenberg HI, O'Donnell K, Rosendahl S (2001) Evolution of *Fusarium oxysporum* f.sp. *vasinfectum* races inferred from multigene genealogies. *Phytopathology* 91:1231–1237
- Small J, Call D, Brockm F, Straub T, Chandler D (2001) Direct detection of 16S rRNA in soil extracts by using oligonucleotide microarrays. *Appl Environ Microbiol* 67:4708–4716
- Stewart JE, Kim MS, James RL, Dumroese RK, Klopfenstein NB (2006) Molecular characterization of *Fusarium oxysporum* and *Fusarium commune* isolates from a conifer nursery. *Phytopathology* 96:1124–1133
- Tringe SG, von Mering C, Kobayashi A, Salamov AA, Chen KN, Chang HW et al (2005) Comparative metagenomics of microbial communities. *Science* 22:554–557
- van der Does HC, Lievens B, Claes L, Houterman PM, Cornelissen BJC, Rep M (2008) The presence of a virulence locus discriminates *Fusarium oxysporum* isolates causing tomato wilt from other isolates. *Environ Microbiol* 10:1475–1485

- van der Nest MA, Steenkamp ET, Wingfield BD, Wingfield MJ (2000) Development of simple sequence repeat (SSR) markers in *Eucalyptus* from amplified inter-simple sequence repeats (ISSR). *Plant Breed* 119:433–436
- van der Wolf JM, van Beckhoven JRCM, Bonanats PJM, Schoen CD (2001) New technologies for sensitive and specific routine detection of plant pathogenic bacteria. In: de Boer SH (ed) *Plant pathogenic bacteria*. Kluwer, Dordrecht, pp 75–77
- Waalwijk C, De Koning JRA, Baayen RP, Gams W (1996) Discordant groupings of *Fusarium* spp from sections *Elegans*, *Liseola* and *Dlaminia* based on ribosomal ITS1 and ITS2 sequences. *Mycologia* 88:316–328
- Wang PH, Lo1 HS, Yeh Y (2001) Identification of *F. oxysporum* cucumerinum and *F. oxysporum* luffae by RAPD-generated DNA probes. *Lett Appl Microbiol* 33:397–401
- Wang B, Brubaker CL, Tate W, Woods MJ, Matheson BA, Burdon JJ (2006) Genetic variation and population structure of *Fusarium oxysporum* f.sp. *vasinfectum* in Australia. *Plant Pathol* 55:746–755
- Ward E (1994) In: Blakemen JP, Williamson B (eds) *Use of polymerase chain reaction for identifying plant pathogens*. CAB International, Oxon, UK
- Whitehead DS, Coddington A, Lewis BG (1992) Classification of races by DNA polymorphism analysis and vegetative compatibility grouping in *Fusarium oxysporum* f.sp. *pisi*. *Physiol Mol Plant Pathol* 41:295–305
- Woudt LP, Neuvel A, Sikkema A, van Grinsven MQJM, de Milliano WAJ, Campbell CL, Leslie JF (1995) Genetic variation in *Fusarium oxysporum* from cyclamen. *Phytopathology* 85:1348–1355
- Wright KGF, Guest DI, Wimalajeewa DLS, Van Heeswijck R (1996) Characterisation of *Fusarium oxysporum* isolated from carnation based on pathogenicity, vegetative compatibility and random amplified polymorphic DNA (RAPD) assay. *Eur J Plant Pathol* 102:451–457
- Zambounis AG, Paplomatas E, Tsafaris AS (2007) Intergenic spacer-RFLP analysis and direct quantification of Australian *Fusarium oxysporum* f.sp. *vasinfectum* isolates from soil and infected cotton tissues. *Plant Dis* 91:1564–1573
- Zeller KA, Jurgenson JE, El-Assiuty EM, Leslie JF (2000) Isozyme and amplified fragment length polymorphisms (AFLPs) from *Cephalosporium maydis* in Egypt. *Phytoparasitica* 28:121–130
- Zhang Z, Zhang J, Wang Y, Zheng X (2005) Molecular detection of *Fusarium oxysporum* f.sp. *niveum* and *Mycosphaerella melonis* in infected plant tissues and soil. *FEMS Microbiol Lett* 249:39–47

# Chapter 8

## Molecular Chemotyping of *Fusarium graminearum*, *F. culmorum*, and *F. cerealis* Isolates From Finland and Russia

Tapani Yli-Mattila and Tatiana Gagkaeva

**Abstract** PCR assays that yield markers that are predictive of NIV versus DON production or 3ADON versus 15ADON production were performed for 60 *Fusarium graminearum* isolates, most of which were from Finland and Russia. None of the *F. graminearum* isolates originating from Finland and north-western Russia produced any PCR fragment with DON and NIV specific primers, which indicates that they have a 3ADON chemotype. All *F. graminearum* isolates from southern Russia and most of the isolates from Asia and Germany produced fragments typical of the 15ADON chemotype. All *F. culmorum* isolates belonged to 3ADON chemotype, while all *F. cerealis* isolates belonged to NIV chemotype. The highest DON levels were found in the 3ADON molecular chemotype isolates of Finland, north-western Russia, and central Russia. In the combined 3ADON molecular chemotype isolates, DON production was clearly higher than in the combined 15ADON chemotype isolates.

### 8.1 Introduction

*Fusarium* head blight (FHB) caused by *Fusarium graminearum* (sexual state *Gibberella zeae*) and related *Fusarium* species is among the most important fungal disease of cereals worldwide (McMullen et al. 1997; Langseth et al. 1999; Bottalico and Perrone 2002; Gagkaeva and Yli-Mattila 2004; Ward et al. 2008). FHB

---

T. Yli-Mattila

Laboratory of Plant Physiology and Molecular Biology, Department of Biology, University of Turku, 20014 Turku, Finland  
e-mail: tymat@utu.fi

T. Gagkaeva

Laboratory of Mycology and Phytopathology, All-Russian Institute of Plant Protection (VIZR), 196608 St. Petersburg-Pushkin, Russia  
e-mail: t.gagkaeva@yahoo.com

pathogens cause significant yield and quality losses and they pose a serious threat to food safety, because they produce mycotoxins. The most important mycotoxins are trichothecenes, such as deoxynivalenol (DON), nivalenol (NIV) and T-2, and zearalenone (ZEN). Multilocus molecular phylogenetic analyses have resolved the *F. graminearum sensu lato* as 13 phylogenetically distinct species (O'Donnell et al. 2000, 2004, 2008; Starkey et al. 2007; Yli-Mattila et al. 2009b). *F. graminearum sensu stricto* is the dominant FHB pathogen in most parts of Europe and North America (Láday et al. 2004; O'Donnell et al. 2000, 2004; Tóth et al. 2005; Yli-Mattila et al. 2009c). Recently *F. graminearum* has been spreading northward in Europe (e.g., Waalwijk et al. 2003; Nicholson et al. 2003) and has been replacing the closely related *F. culmorum*, which produces less DON than *F. graminearum* (Langseth et al. 1999; Jennings et al. 2004a; Jestoi et al. 2004, 2008). However, in some recent studies, *F. culmorum* was still recovered more frequently than *F. graminearum* in cereals e.g., in England, Wales, north-western Russia, and Finland based on percent contamination levels (Shipilova and Gagkaeva 1992; Jennings et al. 2004a, b).

In Finland, FHB (Fig. 8.1) was first reported in the 1930s as a problem in oats (Rainio 1932). *F. graminearum* was reported in Finnish cereals as early as the 1960s (Ylimäki 1981), and subsequently in 1972 (Uoti and Ylimäki 1974); 1976–1977 (Ylimäki et al. 1979); 1982–1984 (Rizzo 1993) and 1998 (Eskola et al. 2001; Yli-Mattila et al. 2002). The highest DON levels have been found in oat (Hietaniemi et al. 2008; Yli-Mattila et al. 2004a, b, 2008a, b, 2009a). High DON levels have also been found in spring wheat and barley, especially in central and western Finland, when harvesting has been delayed. The lowest levels have been found in winter rye and wheat, which are harvested early. Only low levels of ZEN



**Fig. 8.1** Symptoms on spring wheat (cultivar Mahti) 4 weeks after artificial inoculation in Finland

have been found in Finnish field samples (Yli-Mattila et al. 2004a), although *F. graminearum* and *F. culmorum* are the main producers of ZEN (Bottalico and Perrone 2002; Jestoi et al. 2008).

Based on quantitative TaqMan real-time PCR (qPCR) analysis of DNA recovered from cereal grains, *F. graminearum* is already more common than *F. culmorum* in Finland and a highly significant correlation has been found between *F. graminearum* DNA and DON in Finnish oat, barley, and spring wheat (Yli-Mattila et al. 2008a, b), which is in agreement with the results obtained in winter wheat in Sweden (Fredlund et al. 2008). In Finnish barley, *F. culmorum* also seems to contribute to DON production. The highly significant correlation between the level of *F. graminearum*/*F. culmorum* DNA and DON is in agreement with previous results of Waalwijk et al. (2004) and Nicholson et al. (2003) in Europe and Sarlin et al. (2006) in North America.

In Russia, FHB caused by *F. graminearum* was first reported at the end of nineteenth century in the Far East region, where the environmental conditions are favorable to FHB (Voronin 1890). This fungus has not been detected in Siberia and the Ural regions, while in the southern Russia region (North Caucasus), where the first outbreak was reported in 1933 (Pronicheva 1935), *F. graminearum* is the most common causal agent of FHB. Since it was first detected in the North Caucasus region, FHB has reached epidemic levels several times in southern Russia during 1960s, 80s, and 90s and caused reduction of cereal yields (Ivanchenko 1960, Kirienkova 1992). In central Russia, where *F. avenaceum* tends to be the predominant cause of FHB, *F. graminearum* isolates have been found on the central-chernozem territory since 1980s (Selivanova et al. 1991). In the north-western region of Russia, this pathogen was not found until 2003, but since then this pathogen has become more common in this region (Gagkaeva et al. 2009).

There are three distinct subpopulations of *F. graminearum* in the European part of Russia: southern, central, and north-western, which is adjacent to the Finnish population. The distance from the north-western and Finnish population to the southern population is ca. 2,000 km. Central population is located between them and is about 1,000 km from both of them. European *F. graminearum* populations are geographically separated from those in the Russian Far East and China by ca. 6,000 km (Fig. 8.2).

*F. graminearum* isolates can be divided into two main groups (chemotypes) based on mycotoxin production and production profiles. One group produces DON and its acetylated derivatives and the other group produces NIV and its acetylated derivatives. The DON group can be further divided into 3ADON producers and 15ADON producers. The genetic basis of DON versus NIV production results from differences in Tri7 and Tri13 genes. Chemotype-specific PCR primers (Ward et al. 2002; Jennings et al. 2004a, b; Starkey et al. 2007) and multilocus genotyping that utilizes a suspension microarray (Ward et al. 2008) have been developed to predict the chemical phenotype (chemotype) of *F. graminearum* isolates. The chemotypes have also been called chemotype IA (producing 3ADON), IB (producing 15ADON) and II (producing NIV) (Miller et al. 1991). Trichothecene chemotype differences are apparently adaptive and trichothecene chemotype polymorphism has been



**Fig. 8.2** The origin (*black circles*) of *Fusarium* isolates. The origin (*black spots*) of *F. graminearum* isolates in Far East and southern and central Russia have been marked with *arrows* and names. The three populations of *F. graminearum* in north-western Russia/Finland (A), southern and central Russia (B) and Far East (C) have been marked with *black circles*

maintained through multiple speciation events by balancing selection (Ward et al. 2002). The 15ADON chemotype of *F. graminearum* is dominant in USA (Ward et al. 2008), England, and Wales (Jennings et al. 2004a, b) based on molecular and chemical analyses. Recent analyses of 3ADON populations in North America revealed that they had higher average growth rates, produced significantly more conidia, and accumulated significantly more trichothecene than isolates from sympatric 15ADON populations (Ward et al. 2008). NIV chemotype is relatively common e.g., in UK (Jennings et al. 2004b) and in some parts of southern USA (Gale et al. 2007).

The chemical structures of DON and NIV differ from one another only by the presence or absence of a hydroxyl function at carbon atom 4 (C-4) of the core trichothecene molecule; NIV has the C-4 hydroxyl and DON does not. The trichothecene biosynthetic gene *Tri13* is responsible for this structural difference; the *Tri13* protein catalyzes the C-4 hydroxylation. In NIV-producing strains, *Tri13* is functional and the C-4 position is hydroxylated, whereas in DON-producing strains the gene is non-functional due to multiple insertions and deletions in its coding region, and the C-4 position is not hydroxylated (Lee et al. 2002, Brown et al. 2002). Another trichothecene biosynthetic gene, *Tri7*, is responsible for acetylation of the C-4 hydroxyl and thereby is responsible for converting NIV to 4-acetylnivalenol (4-NIV). In DON-producing strains of *F. graminearum*, *Tri7* is also non-functional due to multiple insertions and deletions (Lee et al. 2002; Brown et al. 2001). In at least some DON-producing strains, the nonfunctional *Tri7* contains multiple repetitions of 11-bp sequence which occur only once in the functional *Tri7* of NIV producers (Lee et al. 2001).



In northern Europe, most *F. graminearum* and *F. culmorum* isolates previously studied possessed a 3ADON chemotype (Miller et al. 1991; Langseth et al. 1999; Chandler et al. 2003; Jestoi et al. 2004, 2008) based on chemical and molecular analysis, while in southern-European Russia the 15ADON chemotype was dominant (Leonov et al. 1990). In England and Sweden, the *Tri7* gene of the trichothecene cluster was absent in all *F. graminearum* and *F. culmorum* isolates of the 3ADON chemotype (Chandler et al. 2003; Jennings et al. 2004a, b). In China also it was absent in all *F. asiaticum* (former *F. graminearum* lineage 6) isolates of the 3ADON chemotype (Zhang et al. 2007). A more specific way to separate 3ADON and 15ADON isolates is to use primers based on *Tri3* gene (Ward et al. 2002, Jennings et al. 2004b).

Genetic variation of Finnish and Russian *F. graminearum* isolates has been studied previously by different molecular methods (Yli-Mattila et al. 2004b, Gagkaeva and Yli-Mattila 2004) and by chemical analyses (Jestoi et al. 2004, 2008). In the present study, we reexamined most of these archived isolates as well as some new isolates, for two chemotype-specific PCR markers (Lee et al. 2001, Waalwijk et al. 2003), pathogenicity assays to wheat seedlings, and for DON and ZEN production in culture. The results were compared to those obtained with the previously described multilocus genotyping assay (Yli-Mattila et al. 2009a).

## 8.2 Materials and Methods

### 8.2.1 *Fusarium Isolates*

Isolates used in this study are listed in Tables 8.1 and 8.2 together with their geographic origin (Fig. 8.2), substrate, and results. Most isolates were obtained from small cereals grains. Grain samples were collected in different regions of Russia between 1998 and 2004, in Heilongjiang province (Harbin) of China in 1999 and in Germany in 1998. Six *F. graminearum* isolates from Finland were isolated from grain, root, and stem base. Six additional Finnish *F. graminearum* isolates of the years 2002 and 2003, used in molecular chemotyping, were obtained from grain (Table 8.1). Every isolate was single-spore subcultured and identified by morphological methods (Gerlach and Nirenberg 1982, Marasas et al. 1984, Figs. 8.3 and 8.4). The identification of each *F. graminearum* isolate was confirmed by PCR with species-specific primers Fg11f and Fg11r (Doohan et al. 1998, Waalwijk et al. 2003).

At present all isolates (except for 6 Finnish *F. graminearum* isolates 02–1, 02–3, 02–11, 03–26, 03–27 and 03–28) are stored in the Collection of Laboratory of Mycology and Phytopathology, All-Russian Institute of Plant Protection (VIZR), Russia and ARS Culture Collection (NRRL), Peoria, IL.

**Table 8.1** List of *F. graminearum* isolates used in mycotoxin (ng ml<sup>-1</sup>) and molecular chemotype (GzTri7f1/r1 and Tri13f/r primers) analyses. Six Finnish isolates of the years 2002 and 2003 are without NRRL number. Abbreviations: n.a. = not analyzed, Ru = Russia, CE = central Russia, FE = Far East, NW = north-western Russia, SE = southern Russia

Number in NRRL culture collection	Origin (code for Finnish isolates of the years 2002 and 2003)	Host	Tissue	Year	Toxins, mg ml <sup>-1</sup>		Chemotype-specific primers		Suggested chemotype
					DON	ZEN	GzTri7	Tri13	
45589	Finland, Espoo	Barley	Root	1986	81	<4	–	–	3ADON
45590	Finland, Jalasjärvi	Barley	Stem	1986	138	251	–	–	3ADON
			base						
45595	Finland, Pori	Wheat	Root	1986	399	120	–	–	3ADON
45602	Finland, Ylistaro	Oat	Stem	1993	104	11480	–	–	3ADON
			base						
45845	Finland, Isokyrö (02–06)	Barley	Grain	2002	n.a.	n.a.	–	–	3ADON
45846	Finland, Marttila (02-05)	Barley	Grain	2002	n.a.	n.a.	–	–	3ADON
	Finland, Isokyrö (02-11)	Barley	Grain	2002	n.a.	n.a.	–	–	3ADON
	Finland, Isokyrö (02-01)	Wheat	Grain	2002	n.a.	n.a.	–	–	3ADON
	Finland, Isokyrö (02-03)	Wheat	Grain	2002	n.a.	n.a.	–	–	3ADON
	Central Finland (03-26)	Oat	Grain	2003	n.a.	n.a.	–	–	3ADON
	Central Finland (03-27)	Oat	Grain	2003	n.a.	n.a.	–	–	3ADON
	Eastern Finland (03-28)	Oat	Grain	2003	n.a.	n.a.	–	–	3ADON
45633	Ru, CE, Bryansk	Wheat	Grain	2004	17	<4	n.a.	n.a.	n.a.
45634	Ru, CE, Bryansk	Wheat	Grain	2004	<4	28	n.a.	n.a.	n.a.
45635	Ru, CE, Bryansk	Wheat	Grain	2004	29	188	n.a.	n.a.	n.a.
45636	Ru, CE, Tula	Wheat	Grain	2004	258	<4	n.a.	n.a.	n.a.
45574	Ru, FE, Kamen-Ribolov	Wheat	Grain	1998	15	<4	–	–	3ADON
45615	Ru, FE, Kamen-Ribolov	Wheat	Grain	2003	50	107	–	–	3ADON
45616	Ru, FE, Kamen-Ribolov	Wheat	Grain	2003	13	27	–	–	3ADON
45617	Ru, FE, Kamen-Ribolov	Wheat	Grain	2001	12	25	–	–	3ADON
45630	Ru, FE, Kamen-Ribolov	Wheat	Grain	2003	142	741	n.a.	n.a.	n.a.
45575	Ru, FE, Kamen-Ribolov	Wheat	Grain	1998	<4	795	+	+	15ADON
45599	Ru, FE, Kamen-Ribolov	Wheat	Grain	1998	<4	237	+	+	15ADON
45605	Ru, FE, Kamen-Ribolov	Wheat	Grain	1998	16	<4	+	+	15ADON
45614	Ru, FE, Kamen-Ribolov	Wheat	Grain	2003	20	<4	+	+	15ADON
45579	Ru, FE, Khabarovsk	Wheat	Grain	1998	50	251	+	–	15ADON
45577	Ru, FE, Khabarovsk	Wheat	Grain	1998	8	<4	+	–	15ADON
45606	Ru, FE, Khabarovsk	Wheat	Grain	1998	45	2510	+	+	15ADON
45618	Ru, FE, Ussuriysk	Wheat	Grain	2003	80	43	+	+	15ADON
45628	Ru, FE, Ussuriysk	Wheat	Grain	2002	50	2630	n.a.	n.a.	n.a.
45611	Ru, NW, Leningrad	Wheat	Grain	2003	80	269	–	–	3ADON
45612	Ru, NW, Leningrad	Barley	Grain	2003	224	690	–	–	3ADON
45622	Ru, NW, Leningrad	Barley	Grain	2003	102	251	–	–	3ADON
45623	Ru, NW, Leningrad	Barley	Grain	2003	317	100	–	–	3ADON
45624	Ru, NW, Leningrad	Barley	Grain	2004	200	3550	–	–	3ADON
45625	Ru, NW, Leningrad	Barley	Grain	2004	564	245	–	–	3ADON
45637	Ru, NW, Leningrad	Barley	Grain	2004	170	1410	n.a.	n.a.	n.a.
45584	Ru, SE, Krasnodar	Wheat	Grain	1998	20	<4	+	+	15ADON
45585	Ru, SE, Krasnodar	Wheat	Grain	1998	<4	<4	+	–	15ADON
45586	Ru, SE, Krasnodar	Wheat	Grain	1997	166	12880	+	+	15ADON
45591	Ru, SE, Krasnodar	Wheat	Grain	1997	<4	<4	+	+	15ADON
45600	Ru, SE, Krasnodar	Wheat	Grain	1997	8	186	+	+	15ADON
45578	Ru, SE, North Ossetia	Wheat	Grain	1998	36	243	+	+	15ADON
45580	Ru, SE, North Ossetia	Wheat	Grain	1998	32	126	+	+	15ADON
45581	Ru, SE, North Ossetia	Wheat	Grain	1998	63	5010	+	–	15ADON
45582	Ru, SE, North Ossetia	Wheat	Grain	1998	<4	126	+	–	15ADON
45583	Ru, SE, North Ossetia	Wheat	Grain	1998	87	3980	+	+	15ADON

(continued)

**Table 8.1** (continued)

Number in NRRL culture collection	Origin (code for Finnish isolates of the years 2002 and 2003)	Host	Tissue	Year	Toxins, mg ml <sup>-1</sup>		Chemotype-specific primers		Suggested chemotype
					DON	ZEN	GzTri7	Tri13	
45596	Ru, SE, North Ossetia	Wheat	Grain	1998	<4	243	+	+	15ADON
45607	Ru, SE, North Ossetia	wheat	Grain	2004	<4	200	+	+	15ADON
45608	Ru, SE, North Ossetia	wheat	Grain	2004	316	7080	-	+	15ADON
45609	Ru, SE, North Ossetia	wheat	Grain	2004	6	1260	+	+	15ADON
45610	Ru, SE, North Ossetia	wheat	Grain	2004	<4	56	-	+	15ADON
45619	Ru, SE, North Ossetia	Barley	Grain	2002	8	158	+	+	15ADON
45620	Ru, SE, North Ossetia	Barley	Grain	2002	24	1200	+	+	15ADON
45621	Ru, SE, North Ossetia	Wheat	Grain	2000	21	200	+	+	15ADON
45626	Ru, SE, North Ossetia	Wheat	Grain	2004	10	64	n.a.	n.a.	n.a.
45627	Ru, SE, North Ossetia	Wheat	Grain	2002	<4	76	n.a.	n.a.	n.a.
45629	Ru, SE, North Ossetia	Wheat	Grain	2002	399	<4	n.a.	n.a.	n.a.
45631	Ru, SE, North Ossetia	Wheat	Grain	2004	<4	<4	n.a.	n.a.	n.a.
45632	Ru, SE, North Ossetia	Wheat	Grain	2004	32	23	n.a.	n.a.	n.a.
45576	China, Harbin	Wheat	Grain	1999	12	562	+	+	15ADON
45587	China, Harbin	Wheat	Grain	1999	<4	1350	-	-	3ADON
45588	China, Harbin	Wheat	Grain	1999	126	2510	-	+	15ADON
45593	China, Harbin	Wheat	Grain	1999	41	1200	+	-	15ADON
45594	China, Harbin	Wheat	Grain	1999	8	190	+	+	15ADON
45603	China, Harbin	Wheat	Grain	1998	10	813	+	+	15ADON
45604	China, Harbin	Wheat	Grain	1999	159	63	-	-	3ADON
45592	Germany, Falkenhagen	Wheat	Grain	1998	n.a.	126	+	+	15ADON
45597	Germany, Falkenhagen	Wheat	Grain	1998	<4	129	+	+	NIV
45613	Germany, Falkenhagen	Wheat	Grain	1998	n.a.	n.a.	+	-	15ADON
45601	Germany, Reinshof	Wheat	Grain	1998	<4	295	+	+	15ADON
45598	Germany, Rocking	Wheat	Grain	1998	<4	447	+	+	15ADON

## 8.2.2 DNA Extraction and PCR Chemotyping

The chloroform-octanol method was used for DNA extraction as described by Paavanen-Huhtala et al. (1999). Amplifications with chemotype-specific primers GzTri7f1/r1 (Lee et al. 2001) and Tri13f/r (Waalwijk et al. 2003) were performed for 60 *F. graminearum* isolates using a PTC-200 DNA Engine thermal cycler. According to previous investigations NIV producers generate a PCR fragment of 162 with primers GzTri7f1/r1 and a PCR fragment of 415 bp with primers Tri13f/r, while DON producers generate a PCR fragment of 162 bp plus a multiple of 11 bp with primers GzTri7f1/r1 and a PCR fragment of 234 bp with primers Tri13f/r. Amplifications were performed in 25- $\mu$ l volumes containing Dynazyme reaction buffer (Finnzymes, Espoo, Finland), 150  $\mu$ M each of dNTP and 1–10 ng of fungal DNA. The thermal cycler conditions used were as described by Lee et al. (2001), except that annealing was performed at 52°C. PCR reactions were repeated at least twice. PCR products from 23 isolates obtained with primers GzTri7f1 and GzTri7r1 were separated by electrophoresis in 2% MetaPhor agarose gel (FMC BioProducts, Rockland, ME, USA) in order to measure the length of the PCR product.

**Table 8.2** *F. culmorum*, *F. cerealis*, and *F. graminearum* isolates and chemotypes identified by MLGT analyses. Abbreviations: Ru = Russia, CE = central Russia, FE = Far East, NW = north-western Russia, SE = southern Russia

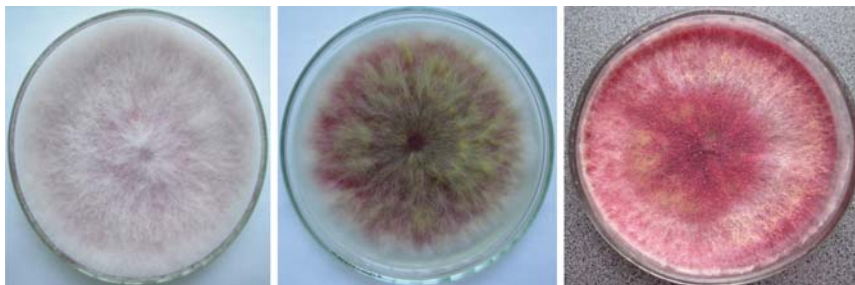
NRRL #	Origin	Host	Tissue	Year	MLGT identification	MLGT chemotype
45592	Germany, Falkenhagen	Wheat	Grain	1998	<i>graminearum</i>	15ADON
45597	Germany, Falkenhagen	Wheat	Grain	1998	<i>graminearum</i>	NIV
45598	Germany, Rocking	Wheat	Grain	1998	<i>graminearum</i>	15ADON
45601	Germany, Reinshof	Wheat	Grain	1998	<i>graminearum</i>	15ADON
45613	Germany, Falkenhagen	Wheat	Grain	1998	<i>graminearum</i>	15ADON
45642	Ru, FE, Khabarovsk	Wheat	Ear	2006	<i>cerealis</i>	NIV
45726	Ru, NW, Arhangelsk	Solani	Potato	2002	<i>culmorum</i>	3ADON
45727	Finland, Marttila	Wheat	Grain	2004	<i>culmorum</i>	3ADON
45752	Finland, Marttila	Wheat	Grain	2004	<i>culmorum</i>	3ADON
45758	Ru, CE, Moscow	Wheat	Grain	2005	<i>culmorum</i>	3ADON
45759	Ru, CE, Moscow	Wheat	Grain	2005	<i>culmorum</i>	3ADON
45765	China, Harbin	Wheat	Grain	2003	<i>cerealis</i>	NIV
45766	China, Harbin	Wheat	Grain	2003	<i>cerealis</i>	NIV
45770	China, Harbin	Wheat	Grain	2003	<i>cerealis</i>	NIV
45771	Ru, CE, Moscow	Wheat	Grain	2004	<i>culmorum</i>	3ADON
45774	Ru, NW, Kaliningrad	Barley	Grain	2006	<i>culmorum</i>	3ADON
45775	China, Harbin	Wheat	Grain	2003	<i>cerealis</i>	NIV
45776	Ru, CE, Moscow	Wheat	Grain	2005	<i>culmorum</i>	3ADON
45777	Ru, Ural region, Bashkiria	Wheat	Root	2005	<i>culmorum</i>	3ADON
45778	Ru, Ural, Bashkiria	Wheat	Root	2005	<i>culmorum</i>	3ADON
45783	Ru, SE, Rostov	Cirsium sp.	Leaf	2004	<i>culmorum</i>	3ADON
45784	Ru, SE, Rostov	Cirsium sp.	Leaf	2004	<i>culmorum</i>	3ADON
45788	Ru, SE, North Ossetia	Cirsium sp.	Leaf	2004	<i>cerealis</i>	NIV
45803	Byelorussia	Wheat	Ear	2003	<i>culmorum</i>	3ADON
45804	Ru, NW, Pskov	Cirsium sp.	Leaf	2004	<i>culmorum</i>	3ADON
45829	Kyrgyzstan	Cirsium sp.	Stem	2005	<i>culmorum</i>	3ADON
45830	Kyrgyzstan	Cirsium sp.	Stem	2005	<i>culmorum</i>	3ADON
45831	Ru, NW, Leningrad	Cirsium sp.	Stem	2005	<i>culmorum</i>	3ADON
45850	Finland, Marttila	Barley	Grain	2002	<i>culmorum</i>	3ADON
45851	Finland, Marttila	Wheat	Grain	2002	<i>culmorum</i>	3ADON
45852	Finland, Marttila	Wheat	Grain	2002	<i>culmorum</i>	3ADON
45854	Finland, Marttila	Wheat	Grain	2003	<i>culmorum</i>	3ADON
45855	Western Finland, Etelä-Pohjanmaa	Oat	Grain	2003	<i>culmorum</i>	3ADON
45856	Southern Finland, Uusimaa	Barley	Grain	2003	<i>culmorum</i>	3ADON
45858	SW Finland, Satakunta	Oat	Grain	2003	<i>culmorum</i>	3ADON
45859	SW Finland, Varsinais-Suomi	Wheat	Grain	2003	<i>culmorum</i>	3ADON
45861	Southern Finland, Uusimaa	Wheat	Grain	2003	<i>culmorum</i>	3ADON
45897	Western Finland, Isokyrö	Barley	Grain	2001	<i>culmorum</i>	3ADON
45898	Finland, Marttila	Barley	Grain	2001	<i>culmorum</i>	3ADON

**Table 8.3** Gene sequences amplified by multiplex PCR and ASPE (allele-specific primer extension, Ward et al. 2008) probes used for MLGT analysis

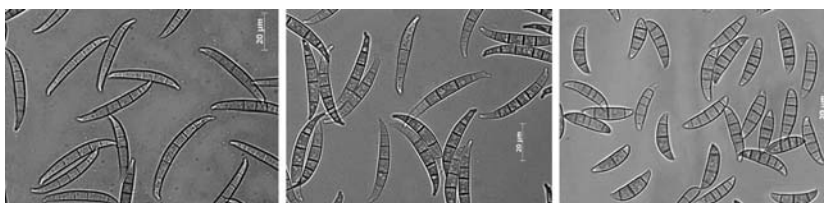
Region	Size (bp)	Probe	Target		
Reductase	702	RED-2	<i>F. meridionale</i>		
		RED-ce	<i>F. cerealis</i>		
		RED-cu	<i>F. culmorum</i>		
		RED-p	<i>F. pseudograminearum</i>		
		RED-3	<i>F. boothi</i>		
		RED-4	<i>F. mesoamericanum</i>		
		RED-9	<i>F. brasilicum</i>		
		Tri-101	911	AT-b	B-FHB clade
				AT-g	Fg complex
AT-1	<i>F. austroamericanum</i>				
AT-2	<i>F. meridionale</i>				
AT-ce	<i>F. cerealis</i>				
AT-cu	<i>F. culmorum</i>				
AT-p	<i>F. pseudoamericanum</i>				
AT-sp	<i>Fusarium</i> sp.				
AT-3	<i>F. boothi</i>				
AT-4	<i>F. mesoamericanum</i>				
AT-5	<i>F. acaciae-mearnsii</i>				
AT-6	<i>F. asiaticum</i>				
AT-7	<i>F. graminearum</i>				
AT-8	<i>F. cortaderiae</i>				
EF	456			EF-g	Fg complex
				EF-1	<i>F. mesoamericanum</i>
		EF-L	<i>F. lunulosporum</i>		
		EF-sp	<i>Fusarium</i> sp.		
		EF-5	<i>F. acaciae-mearnsii</i>		
		EF-7	<i>F. graminearum</i>		
		EF-8	<i>F. cortaderiae</i>		
		MAT	1040	MAT-L	<i>F. lunulosporum</i>
MAT-6	<i>F. asiaticum</i>				
MAT-9	<i>F. brasilicum</i>				
Tri-3	912	T3-15ADON	15ADON		
		T3-3ADON	3ADON		
		T3-NIV	NIV		
Tri-12	1163	T12-15ADON	15ADON		
		T12-3ADON	3ADON		
		T12-NIV	NIV		

### 8.2.3 Multilocus Genotyping

The species and trichothecene chemotype composition of German *F. graminearum* isolates and *F. culmorum* and *F. cerealis* isolates were investigated using multiplex PCR with six primer pairs followed by a 37 probe version (Table 8.3) of six gene sequences of the multilocus genotyping (MLGT) assay. The products of the first PCR were used as templates in the multilocus genotyping assay. Multiplex amplifications, allele-specific primer extensions, microsphere hybridization, and



**Fig. 8.3** *Fusarium graminearum* (left), *F. cerealis* (middle), and *F. culmorum* (right) conidia on SNA medium after 2 weeks in the dark



**Fig. 8.4** *Fusarium graminearum* (left), *F. cerealis* (middle) and *F. culmorum* (right) conidia on SNA medium after two weeks in the dark

detection were performed as described by Ward et al. (2008). Hybridization and detection were performed using a Luminex 100 flow cytometer.

### 8.2.4 Mycotoxin Analyses

A panel of 62 and 63 *F. graminearum* isolates was screened for DON and zearalenone (ZEN) production by indirect ELISA (enzyme linked immunosorbent assay, Kononenko and Burkin 2002). Every isolate was cultivated for 7 days in a small glass bottle (diameter 18 mm) with 1 ml PSA medium at 23°C. Then cultures of isolates were extracted with 1 ml of acetonitrile: water (6:1) and extracts were analyzed by ELISA, with detection limit 20 ng ml<sup>-1</sup> of extract.

### 8.2.5 Pathogenicity Analysis

The pathogenicity of *F. culmorum* (45726, 45776, 45777, 45784, 45803), *F. graminearum* (45618, 45633, 45702, 45710, 45720, 45744, 45827, 45636, 45638, 45713, 45762, 45799, 45832), and *F. cerealis* (45775, 45788, 45642) isolates was examined according to the modified method of Chelkowski and Manka (1983).

Surface sterilized grains of winter wheat (cv. Moscovskay 39) were kept for one day in sterile water. Then healthy germinated grains were placed on the surface of the fungal colony, which was grown for one week on potato sucrose agar (PSA). The experiments were performed in 2 replicates, with 30 grains in three Petri dishes per replicate. In controls, 50 grains in five Petri dishes were placed on the surface of PSA medium in 2 replicates. The length of the seedlings and necrosis were estimated after one week of incubation in darkness at 23°C. The length of every seedling was measured and the mean of every isolate was compared to control. The symptoms of necrosis on the seedlings were evaluated using a scale with classes: 0 = healthy seedlings, 1 = small spots of necrosis on seedlings, 2 = nearly 50% of the seedlings covered by brown lesions, 3 = more than 50% of the seedlings have brown lesions or the seedlings are dead.

### 8.3 Results

#### 8.3.1 Molecular Chemotype Determination with *Tri7* and *Tri13* Primer Pairs

When we analyzed the molecular chemotype results from the gel, we could find that none of the six *F. graminearum* isolates originating from north-western region of Russia and 12 isolates from Finland produced any PCR fragment with primers GzTri7f1/r1 and Tri13f/r (Tables 8.1 and 8.4). According to Kimura et al. (2003); Chandler et al. (2003) and Jennings et al. (2004a, b) the isolates which do not produce any PCR fragment with GzTri7f1/r primers belong to the chemotype 3ADON. So, it was possible to divide the isolates into 3ADON and 15ADON molecular chemotypes based on the presence or absence of amplicons, which in previous studies (Lee et al. 2001; Waalwijk et al. 2003) were shown to be markers for DON-producing isolates.

Most isolates of the suggested 15ADON molecular chemotype yielded the DON-specific amplification fragment with GzTri7f1/r1 (31/34 isolates) and

**Table 8.4** Frequency of PCR fragments produced by *F. graminearum* isolates with chemotype-specific primers GzTri7f1/r1 and Tri13f/r

Origin of isolates	<i>n</i>	% of isolates producing the PCR fragment, bp			
		GzTri7f1/r1		Tri13f/r	
		161	(161 + x11)	412	234
Finland	12	0	0	0	0
North-western Russia	6	0	0	0	0
Southern Russia	18	0	89	0	83
Far East of Russia	12	0	75	0	50
China	7	0	71	0	71
Germany	5	20	80	20	60
Total	60				

Tri13f/r primers (28/34 isolates). Six of the suggested 15ADON molecular chemotype isolates (NRRL 45579, 45577, 45585, 45581, 45582, and 45613) did not yield an amplicon with the GzTri7f1/r1 primer pair but did yield an amplicon with the Tri13f/r primer pair, while three isolates (NRRL 45608, 45610, and 45588) yielded an amplicon only with the primer pair Tri13f/r (Table 8.1).

Most of the isolates from Asia (13/19 isolates), southern Russia (18/18 isolates), and Germany (4/5 isolates) produced fragments typical of the 15ADON molecular chemotype by at least one of the two primer pairs. Only one isolate (Germany, G.8-8) had an NIV molecular chemotype based on PCR products (Tables 8.1 and 8.4).

The size of the PCR product obtained in 15ADON isolates with GzTri7f1/r1 primers was greatest in three isolates from North Ossetia collected in 1998 (206 bp). In the rest of 15ADON molecular chemotype isolates, the size was 173-195 bp (2–6 copies of the 11 bp repetition) and the biggest 15ADON group (11/22 isolates) had a PCR product of 184 bp. A single strain yielded an amplicon of 162 bp with primers GzTrif1/ri, and this is indicative of NIV production. The size variation of the PCR product between the 15ADON isolates was smaller than between the 50 isolates of Lee et al. (2001), who found 2–16 copies of the 11 bp repeat that occurs within *Tri7*.

### 8.3.2 *Multilocus Genotyping*

The results of German *F. graminearum* isolates with MLGT assay were in accordance with the results obtained with molecular chemotype assays. All *F. culmorum* isolates possessed the 3ADON molecular chemotype. In contrast, all six isolates of *F. cerealis* possessed the NIV molecular chemotype (Table 8.2). The species identifications of the isolates in Table 8.2 could also be confirmed by using the MLGT assay.

### 8.3.3 *DON and ZEN Production*

There were differences in mycotoxin production between *F. graminearum* isolates from different regions. Most *F. graminearum* isolates produced DON (47/62 isolates) and ZEN (51/63 isolates) (Table 8.1). The highest DON levels were produced by isolates with the 3ADON molecular chemotype that were from Finland and north-western Russia. Isolates from southern Russia with the 15ADON molecular chemotype produced lower levels of DON. Among all isolates with the 3ADON molecular chemotype, DON production was higher ( $154 \pm 39$  ng ml<sup>-1</sup>) than among all isolates with the 15ADON molecular chemotype ( $37 \pm 11$  ng ml<sup>-1</sup>). In contrast, there was no apparent difference in the levels of ZEN production between isolates with the 3ADON and 15ADON markers ( $1159 \pm 723$  ng ml<sup>-1</sup>



**Table 8.5** DON and ZEN production (mean  $\pm$  SE) by *F. graminearum* isolates in 3ADON and 15ADON chemotypes

Origin of isolates	Chemotype (n)	Toxin production, ng ml <sup>-1</sup>	
		DON	ZEN
Finland	3ADON (4)	180 $\pm$ 74	2964 $\pm$ 2839
North-western Russia	3ADON (6)	248 $\pm$ 72	851 $\pm$ 546
Southern Russia	15ADON (18)	45 $\pm$ 19	1831 $\pm$ 808
Far East of Russia	3ADON (4)	23 $\pm$ 9	41 $\pm$ 23
	15ADON (8)	28 $\pm$ 10	481 $\pm$ 305
China	3ADON (2)	82	438
	15ADON (5)	39 $\pm$ 22	1055 $\pm$ 399
Germany	15ADON (2/3)	<4	254 $\pm$ 93
	NIV (1)	<4	129
Total	50/51		

**Table 8.6** Pathogenicity of *F. graminearum* (15 ADON and 3 ADON chemotypes), *F. culmorum* (3ADON chemotype), and *F. cerealis* (NIV chemotype) to seedlings of winter wheat cv. Moskovskay 39 as compared to controls

<i>Fusarium</i> sp.	Chemotype	No. of isolates	The length of seedlings as compared to controls, %	Necrosis, score
<i>F. graminearum</i>	15 ADON	7	20.82 $\pm$ 4.6	2.63 $\pm$ 0.2
<i>F. graminearum</i>	3 ADON	6	11.93 $\pm$ 2.6	2.94 $\pm$ 0.05
<i>F. culmorum</i>	3 ADON	5	18.7 $\pm$ 3.6	2.9 $\pm$ 0.06
<i>F. cerealis</i>	NIV	3	27.8 $\pm$ 5.6	2.6 $\pm$ 0.3
Control			100	0

in 3ADON isolates and 1362  $\pm$  438 ng ml<sup>-1</sup> in 15ADON isolates), except in Russian Far East, where the isolates of the 15ADON chemotype produced clearly more ZEN than the combined isolates of 3ADON chemotype (Table 8.5), while in this area no clear difference was found in DON production between 3ADON and 15ADON isolates. The highest ZEN levels were produced by the *F. graminearum* isolates from southern Russia and by one Finnish isolate from oats (Table 8.1).

### 8.3.4 Pathogenicity of Isolates

We analyzed the pathogenicity of isolates by determining their effect on seed germination, growth, and disease symptoms in the moderate resistant wheat cultivar Moskovskay 39. Seeds treated with all isolates of *Fusarium* resulted in significantly shorter seedlings than untreated, control seeds. In addition, large lesions were observed on seedlings resulting from treated seeds but not on seedlings resulting from untreated seeds (Table 8.6). *F. graminearum* isolates with 3ADON marker inhibited seed germination and reduced seedling growth significantly more than those with 15ADON marker. *F. culmorum* isolates with the 3ADON markers

also reduced seed germination and seedling growth more than *F. graminearum* isolates with 15ADON marker. The three *F. cerealis* isolates with NIV marker reduced seed germination and seedling growth less than the *F. graminearum* and *F. culmorum* isolates examined. The isolates examined exhibited a similar trend with respect to necrotic lesions. Isolates of *F. graminearum* and *F. culmorum* with the 3ADON molecular chemotype caused larger necrotic lesions on seedlings than isolates of *F. graminearum* with the 15ADON marker or isolates of *F. cerealis* with the NIV marker.

## 8.4 Discussion

Although the 3ADON and 15ADON genetic markers of multilocus genotyping are highly correlated with trichothecene production profiles, there is no evidence that the genetic differences corresponding to the different PCR markers are the cause of the chemotypes with different production profiles. The *Tri3* protein catalyzes acetylation of the C-15 hydroxyl, but *Tri3* seems to be fully functional in both 3ADON and 15ADON producers. The *Tri12* protein is an efflux pump that most likely pumps trichothecenes out of the cells in which they are synthesized (Desjardins 2006). So, it is not clear, how the genetic differences corresponding to the markers at *Tri3* and *Tri12* could lead to the differences in 3ADON and 15ADON production. This is in contrast to the *Tri7* and *Tri13* markers, for which it is quite clear that the genetic differences corresponding to the PCR markers directly cause the difference in the trichothecene production profiles.

One *F. graminearum* strain from Far East has been shown to give a positive signal with the 3ADON probe from the *Tri12* gene and with the 15ADON probe from the *TRI3* gene suggesting that it may reflect recombination between isolates with these two chemotypes (Yli-Mattila et al. 2009b). The result is similar to the information of the article of Mirocha et al. (2003), according to whom Yoshizawa and Morooka (1973) had found a 3,15ADON isolate of *F. graminearum* in wheat and to the chromatographic analysis of one single-spore isolate from southern Russia, which produced both 3ADON and 15ADON based on chemical chromatographic analysis (Leonov et al. 1988).

Kimura et al. (2003), Chandler et al. (2003) and Jennings et al. (2004a, b) have shown that isolates, which do not produce any PCR fragment with GzTri7f1/r primers belong to the chemotype 3ADON, because the *Tri7* gene is deleted from all 3ADON isolates. Based on the results of the present work it also seems that isolates with the 3ADON molecular marker in most cases do not produce any PCR fragment with primers Tri13f/r. The only exception was one Chinese isolate (45603), which produced a PCR fragment with primers GzTri7f1/r and Tri13f/r. Ji et al. (2007) have also found Chinese 3ADON isolates of *F. asiaticum* and *F. graminearum*, which produced a PCR fragment with Tri13f/r primers.

Forty-six of the 51 *F. graminearum* isolates tested with both the MLGT assay by Yli-Mattila et al. (2009b) and chemotype specific primer pair GzTri7f1/r1 in the present work produced concordant results. Ten isolates of Table 8.1 (45610, 45629, 45845, 45846, 02–01, 02–03, 02–11, 03–26, 03–27, 03–28) were not analyzed by MLGT assay. Most of the 15ADON molecular chemotype isolates produced the DON-specific amplification fragment both with GzTri7f1/r1 (31/34 isolates) and Tri13f/r primers (25/34 isolates). Seven of the 15ADON molecular marker chemotype isolates (isolates 45577, 45579, 45581, 45582, 45585, 45593, and 45613), which gave a positive result with GzTri7f1/r1 primers, did not produce the DON-specific amplification product with primers Tri13f/r. Only one *F. graminearum* isolate from China (isolate 45587), which gave a negative result with both primer pairs and was identified as a 3ADON molecular chemotype isolate in the present work, was later found to be a 15ADON molecular chemotype isolate based on MLGT assay (Yli-Mattila et al. 2009b). In addition, isolates 45588 from China and 45608 from North Ossetia having the 15ADON molecular marker (based on MLGT analysis) gave a negative result with primer pair GzTri7f1/r1. The 26 isolates of 3ADON chemotype (based on MLGT analysis) did not produce any amplification product, except for two isolates from North Ossetia (isolate 45596) and China (isolate 45603), which produced an amplification product both with Tri13f/r and GzTri7f1/r primers.

The molecular chemotype and MLGT results of the present work and those of Yli-Mattila et al. (2009b) are consistent with previous mycotoxin analyses of pure cultures of Finnish FHB isolates on autoclaved rice (Jestoi et al. 2004, 2008) and analyses of field samples (Yli-Mattila et al. 2008a, b), according to which Finnish *F. graminearum* and *F. culmorum* isolates belong to 3ADON chemotype.

The idea that most 3ADON molecular chemotype isolates do not produce any PCR fragment with GzTri7f1/r and Tri13f/r primers is in agreement with the results of Waalwijk et al. (2003). According to Waalwijk et al. (2003) 26% of the Dutch *F. culmorum* isolates and 14% of the Dutch *F. graminearum* isolates did not produce any fragment with GzTri7f1/r primers, while 21% and 12% of the isolates of the same species did not produce any fragment with Tri13 primers. This probably means that ca. 20–25% of these Dutch *F. culmorum* and ca. 12–14% of the Dutch *F. graminearum* isolates belonged to the 3ADON molecular chemotype.

Genotyping by chemotype-specific PCR may indicate only that mycotoxin gene is present, but it does not guarantee that the mycotoxin is produced or predict the levels of mycotoxin produced. According to the results of the present paper, 3ADON molecular genotypes produce usually more DON than 15ADON molecular genotypes, which is in agreement with the results obtained in certain areas of North America (Ward et al. 2008). According to Ward et al. (2008) and Yli-Mattila et al. (2008b, 2009b), 3ADON molecular chemotype frequencies among *F. graminearum* are increasing in certain areas of North America and Russian Far East, while in Russian Far East a new 3ADON producing species of *F. graminearum* species complex, *Fusarium ussurianum*, was recently found. In 1998 ten of 14 *F. graminearum* isolates collected in Russian Far East and Harbin in China were of the 15ADON molecular chemotype, while in 2006 twelve of 18 *F. graminearum* isolates had the 3ADON molecular chemotype (Yli-Mattila et al. 2009b).

3ADON molecular chemotype isolates of *F. graminearum* and *F. culmorum* inhibited more strongly the growth of wheat seedlings and caused more necrotic lesions than 15ADON molecular chemotype isolates of *F. graminearum* and NIV isolates *F. cerealis*. This is in accordance with higher DON production of 3ADON molecular chemotype isolates in the present work and previous investigations (Ward et al. 2008) as compared to 15ADON molecular chemotype isolates. Only 3ADON molecular chemotype of *F. graminearum* was detected in the population of north-western Russia, where *F. graminearum* was not found until 2003. This population is probably related to the older 3ADON molecular chemotype population in Finland. Since, fitness is better (Ward et al. 2008) and 3ADON phytotoxicity and pathogenic potential are higher in 3ADON molecular chemotype isolates as compared to 15ADON molecular chemotype isolates, the increase of 3ADON chemotype of *F. graminearum* on new cereal production areas may be dangerous both for plant and mammal health.

**Acknowledgments** We are indebted to Drs. A. Burkin and G. Kononenko from Laboratory of Mycotoxicology, All-Russian Institute for Veterinary Sanitation, Hygiene, and Ecology, Moscow, Russia for performing mycotoxins analyses. The visits of Dr. T. Yli-Mattila to the All-Russian Plant Protection Institute and the visits of Dr. T. Gagkaeva to the University of Turku were supported financially by the Academy of Finland (no. 126917 and 131957) and the Nordic network project New Emerging Mycotoxins and Secondary Metabolites in Toxicogenic Fungi of Northern Europe (project 090014), which is funded by the Nordic Research Board. The authors are grateful to Drs. K. O'Donnell and T. Ward from USDA Research Institute in Peoria in USA for comments on the previous version of the manuscript and to Dr. Robert Proctor from the same institute for comments on the final version and for linguistic revision.

## References

- Bottalico A, Perrone G (2002) Toxicogenic *Fusarium* species and mycotoxins associated with head blight in small-cereals in Europe. *Eur J Plant Pathol* 108:611–624
- Brown DW, McCormick SP, Alexander HJ, Proctor RH, Desjardins AE (2001) A genetic and biochemical approach to study trichothecene diversity in *Fusarium sporotrichioides* and *Fusarium graminearum*. *Fungal Genet Biol* 32:121–133
- Brown DW, McCormick SP, Alexander HJ, Proctor RH, Desjardins AE (2002) Inactivation of cytochrome P450 is a determinant of trichothecene diversity in *Fusarium* species. *Fungal Genet Biol* 36:224–233
- Chandler EA, Simpson DR, Sthonsett MA, Nicholson P (2003) Development of PCR assays to *Tri7* and *Tri13* trichothecene biosynthetic genes, and characterisation of chemotypes of *Fusarium graminearum* and *Fusarium cerealis*. *Phys Mol Plant Pathol* 62:355–367
- Chelkowski J, Manka M (1983) The ability of *Fusaria* pathogenic to wheat, barley and corn to produce zearalenone. *Phytopathologische Zeitschrift-J Phytopathol* 106:354–359
- Desjardins AE (2006) *Fusarium* mycotoxins: Chemistry, Genetics and Biology. American Phytopathology Society, St Paul, MN
- Doohan FM, Parry DW, Jenkinson P, Nicholson P (1998) The use of species-specific PCR-based assays to analyse *Fusarium* ear blight of wheat. *Plant Pathol* 47:197–205
- Eskola M, Parikka P, Rizzo A (2001) Trichothecenes, ochratoxin A and zearalenone contamination and *Fusarium* infection in Finnish cereal samples in 1998. *Food Addit Contam* 18:707–718

- Fredlund E, Gidlund A, Olsen M, Börjesson T, Spliid NHH, Simonsson M (2008) Method evaluation of *Fusarium* DNA extraction from mycelia and wheat for down-stream real-time PCR quantification and correlation to mycotoxin levels. *J Microbiol Methods* 73:33–40
- Gagkaeva T, Yli-Mattila T (2004) Genetic diversity of populations of *Fusarium graminearum* in Europe and Asia. *Eur J Plant Pathol* 110:551–562
- Gagkaeva TYu, Levitin MM, Nazarova LN, Sanin SS (2009) Infected grain and complex of *Fusarium* fungi on the territory of Russia Federation for 2004–2006 years. *Agro XXI* (n4–6): 4–6
- Gale LR, Harrison SA, Milus EA, Ochocki JE, O'Donnell K, Ward TJ, Kistler, HC (2007) Diversity in *Fusarium graminearum sensu stricto* from the U.S: an update. In: Proceedings of the 2007 National Fusarium Head Blight Forum. The Westin Crown Center, Kansas City, Missouri 2–4 December 2007, p 26
- Gerlach TR, Nirenberg H (1982) The genus *Fusarium* – a pictorial atlas. Kommissionsverlag Paul Parey, Berlin
- Hietaniemi V, Rämö S, Koivisto T, Pitkänen T, Ketoja E, Kartio M, Varimo K, Peltone S (2008) Viljojen mykotoksiinit Suomessa. In Happonen A (ed) Maataloustieteen Päivät 2008. Suomen Maataloustieteellisen Seuran tiedotteita no 23. Cited August 26, 2009. Published on January 9, 2008. ISBN 978-951-9041-51-3 (in Finnish)
- Ivanchenko MY (1960) Causal organisms of *Fusarium* head blight and their teleomorph stage in North Ossetia. *Plant Protection* 12:26–28 (in Russian)
- Jennings P, Coates ME, Turner JA, Chandler EA, Nicholson P (2004a) Determination of deoxynivalenol and nivalenol chemotypes of *Fusarium culmorum* isolates from England and Wales by PCR assay. *Plant Pathol* 53:182–190
- Jennings P, Coates ME, Walsh K, Turner JA, Nicholson P (2004b) Determination of deoxynivalenol- and nivalenol-producing chemotypes of *Fusarium graminearum* isolates from wheat crops in England and Wales. *Plant Pathol* 53:643–652
- Jestoi M, Paavananen-Huhtala S, Uhlig S, Rizzo A, Yli-Mattila T (2004) Mycotoxins and cytotoxicity of Finnish *Fusarium* strains grown on rice cultures. In: Canty SM, Boring T, Wardwell J, Ward RW (eds) Proceedings of the 2nd International Symposium on Fusarium Head Blight; incorporating the 8th European Fusarium seminar; 2004, 11–15; Orlando, FL. USA. Michigan State University, East Lansing, MI, pp 405–409
- Jestoi M, Paavananen-Huhtala S, Parikka P, Yli-Mattila T (2008) *In vitro* and *in vivo* mycotoxin production of *Fusarium* isolated from Finnish grains. *Arch Phytopathol Plant Prot* 41:545–558
- Ji L, Cao T, Hu T, Wang S (2007) Determination of deoxynivalenol and nivalenol chemotypes of *Fusarium graminearum* isolates from China by PCR assay. *J. Phytopathol* 155:505–512
- Kimura M, Tokai T, O'Donnell K, Ward TJ, Fujimura M, Hamamoto H, Shibata T, Yamaguchi I (2003) The trichothecene biosynthesis gene cluster of *Fusarium graminearum* F15 contains a limited number of essential pathway genes and expressed non-essential genes. *FEBS Lett* 539:105–110
- Kirienkova AE (1992) *Fusarium* head blight of cereals in Krasnodar krai. In: Goncharov VT (ed) *Fusarium* head blight of cereals Krasnodar. 27:28 (in Russian)
- Kononenko GP, Burkin AA (2002) *Fusarium* toxins in grain food. *Vete pathol* 2:128–132 (in Russian)
- Láday M, Juhász Á, Mule G, Moretti A, Szécsi Á, Logrieco A (2004) Mitochondrial DNA diversity and lineage determination of European isolates of *Fusarium graminearum* (*Gibberella zeae*). *Eur J Plant Pathol* 110:545–550
- Langseth W, Bernhoft A, Rundberget T, Kosiak B, Gareis M (1999) Mycotoxin production and cytotoxicity of *Fusarium* strains isolated from Norwegian cereals. *Mycopathologia* 144:103–113
- Lee T, Han Y-K, Kim K-H, Yun S-H, Lee Y-W (2002) *Tri13* and *Tri7* determine deoxynivalenol- and nivalenol-producing chemotypes of *G. zeae*. *Appl Env Microbiol* 68:2148–2154
- Lee T, Oh DW, Kim H-S, Lee J, Kim Y-H, Youn S-H, Lee YW (2001) Identification of deoxynivalenol- and nivalenol-producing chemotypes of *Gibberella zeae*. *Appl Environ Microbiol* 67:2966–2972

- Leonov AN, Kononenko GP, Soboleva NA (1990) Production of DON-related trichothecenes by *Fusarium graminearum* Schw from Krasnodarski krai of the USSR. *Mycotox Res* 6:54–60
- Marasas WFO, Nelson PE, Toussoun TA (1984) Toxigenic *Fusarium* species: Identity and Mycotoxicology. Pennsylvania State University Press, University Park, Pennsylvania
- McMullen M, Jones R, Gallenberg D (1997) Scab of wheat and barley: a re-emerging disease of devastating impact. *Plant Dis* 81:1340–1346
- Miller JD, Greenhalgh R, Wang Y, Lu M (1991) Trichothecene chemotypes of three *Fusarium* species. *Mycologia* 83:121–130
- Mirocha CJ, Xie W, Filho ER (2003) Chemistry and detection of *Fusarium* mycotoxins. In: Leonard KJ, Bushnell WR (eds) *Fusarium* head blight of wheat and barley. APS Press, St. Paul, pp 144–164
- Nicholson P, Chandler E, Draeger RC, Gosnan NE, Simpson DR, Thomsett M, Wilson AH (2003) Molecular Tools to Study Epidemiology and Toxicology of *Fusarium* Head Blight of Cereals. *Eur J Plant Pathol* 109:691–702
- O'Donnell K, Kistler HC, Tacke BK, Casper HH (2000) Gene genealogies reveal global phylogeographic structure and reproductive isolation among lineages of *Fusarium graminearum*, the fungus causing wheat scab. *Proc Natl Acad Sci USA* 97:7905–7910
- O'Donnell K, Ward TJ, Geiser DM, Kistler HC, Aoki T (2004) Genealogical concordance between the mating type locus and seven other nuclear genes supports formal recognition of nine phylogenetically distinct species within the *Fusarium graminearum* clade. *Fungal Genet Biol* 41:600–623
- O'Donnell K, Ward TJ, Aberra D, Kistler HC, Aoki T, Orwig Kimura M, Bjørnstad Å, Klemsdal S (2008) Multilocus genotyping and molecular phylogenetics resolve a novel head blight pathogen within the *Fusarium graminearum* species complex from Ethiopia. *Fungal Genet Biol* 45:1514–1522
- Paavanen-Huhtala S, Hyvönen J, Bulat SA, Yli-Mattila T (1999) RAPD-PCR, isozyme, rDNA RFLP and rDNA sequence analyses in identification of Finnish *Fusarium oxysporum* isolates. *Mycol Res* 103:625–634
- Pronicheva LL (1935) *Fusarium* head blight of wheat in Azovo-Chernomorskoi krai in 1934 and effect on yield. *Plant Protection*. 9:129:137 (in Russian)
- Rainio AJ (1932) Punahome *Fusarium roseum* Link. – *Gibberella saubinettii* (Mont.) Sacc. ja sen aiheuttamat myrkytykset kaurassa (*Fusarium roseum* beim Hafer und dadurch hervorgerufene Vergiftungen). *Valtion Maatalouskoetöiminnan Julkaisuja* 50:1–45 (in Finnish)
- Rizzo AF (1993) Determination of major naturally occurring *Fusarium* toxins in Finnish grains and feeds. The hemolytic activity of DON and T-2 toxin, and the lipid peroxidation induced in experimental animals. Ph.D. thesis, University of Helsinki
- Sarlin T, Yli-Mattila T, Jestoi M, Rizzo A, Paavanen-Huhtala S, Haikara A (2006) Real-time PCR for quantification of toxigenic *Fusarium* species in barley and malt. *European J Plant Pathol* 114:371–380
- Selivanova TN, Baikova OV, Chernenko VYu (1991) *Fusarium* head blight in central-chernozem region. In Morosova LN (ed) *Problems of protection of cereals against Fusarium head blight and others diseases*. Minsk. 64:67 (in Russian)
- Shipilova NP, Gagkaeva TY (1992) *Fusarium* head blight in north-western region of Russia. *Plant Prot*. N11:7–8 (in Russian)
- Starkey DE, Ward TJ, Aoki T, Gale LR, Kistler HC, Geiser DM, Suga H, Toth B, Varga T, O'Donnell K (2007) Global molecular surveillance reveals novel *Fusarium* head blight species and trichothecene toxin diversity. *Fungal Genet Biol* 44:1191–1204
- Tóth B, Mesterházy Á, Horváth Z, Bartók T, Varga M, Varga J. (2005) Genetic variability of central European isolates of the *Fusarium graminearum* species complex. *Eur J Plant Pathol* 113:35–45
- Uoti J, Ylimäki A (1974) The occurrence of *Fusarium* species in cereal grain in Finland. *Ann Agric Fenniae* 13:5–17

- Voronin MC (1890) About temulent corn in the South-Ussuriiskij region. Botanical notes. SPb, Russia. 3, 1:13–21 (in Russian)
- Waalwijk C, Kastelein P, de Vries I, van der Kerenski Z, Lee T, Hesselink T, Kema G (2003) Major changes in *Fusarium* spp. in wheat in the Netherlands. Eur J of Plant Pathol 109:743–754
- Waalwijk C, van der Heide R, de Vries I, van der Lee T, Schoen C, Costrel-de Corainville G, Häuser-Hahn I, Kastelein P, Köhl J, Lonnet P, Demarquet T, Kema GHJ (2004) Quantitative Detection of *Fusarium* Species in Wheat Using TaqMan. Eur J Plant Pathol 110:481–494
- Ward TJ, Bielawski JP, Kistler HC, Sullivan E, O'Donnell K (2002) Ancestral polymorphism and adaptive evolution in the trichothecene mycotoxin gene cluster of phytopathogenic *Fusarium*. Proc Natl Acad Sci USA 99:9278–9283
- Ward TJ, Clear R, Rooney A, O'Donnell K, Gaba D, Patrick S, Starkey D, Gilbert J, Geiser D, Nowicki T (2008) An adaptive evolutionary shift in *Fusarium* head blight pathogen populations is driving the rapid spread of more toxigenic *Fusarium graminearum* in North America. Fungal Genet Biol 45:473–484
- Ylimäki A (1981) The mycoflora of cereal seeds and some feedstuffs. Ann Agric Fenniae 20:74–88
- Ylimäki A, Koponen H, Hintikka E-L, Nummi M, Niku-Paavola M-L, Ilus T, Enari TM (1979) Mycoflora and occurrence of *Fusarium* toxins in Finnish grain. Technical Research Centre of Finland, Materials and Processing Technology publication 21 (pp. 1–28). Valtion Painatuskeskus, Helsinki
- Yli-Mattila T, Paavanen-Huhtala S, Parikka P, Hietaniemi V, Jestoi M, Rizzo A (2004a) Toxigenic fungi and mycotoxins in Finnish cereals. In: Logrieco A, Visconti A (eds) An overview on toxigenic fungi and mycotoxins in Europe. Kluwer Academic Publishers, The Netherlands, pp 83–100
- Yli-Mattila T, Paavanen-Huhtala S, Parikka P, Konstantinova P, Gagkaeva T (2004b) Molecular and morphological diversity of *Fusarium* species in Finland and northwestern Russia. Eur J Plant Pathol 110:573–585
- Yli-Mattila T, Paavanen-Huhtala S, Parikka P, Konstantinova P, Gagkaeva T, Eskola M, Rizzo A (2002) Occurrence of *Fusarium* fungi and their toxins in Finnish cereals in 1998 and 2000. J Appl Genet 43A: 207–214
- Yli-Mattila T, Paavanen-Huhtala S, Parikka P, Hietaniemi V, Jestoi M, Gagkaeva T, Sarlin T, Haikara A, Laaksonen S, Rizzo A (2008a) Real-time PCR detection and quantification of *Fusarium poae*, *F. graminearum*, *F. sporotrichioides* and *F. langsethiae* as compared to mycotoxin production in grains in Finland and Russia. – Arch. Phytopathol Plant Prot 41:243–260
- Yli-Mattila T, O'Donnell K, Ward T, Gagkaeva T (2008b) Trichothecene chemotype composition of *Fusarium graminearum* and related species in Finland and Russia. J Plant Pathol 90:S60
- Yli-Mattila T, Gagkaeva T, Ward TJ, Aoki T, Kistler HC, O'Donnell K (2009b) A novel Asian clade within the *Fusarium graminearum* species complex includes a newly discovered cereal head blight pathogen from the Far East of Russia. Mycologia (in press)
- Yli-Mattila T, Parikka P, Lahtinen T, Ramo S, Kokkonen M, Rizzo A, Jestoi M, Hietaniemi V (2009b) *Fusarium* DNA levels in Finnish cereal grains. In: Gherbawy Y, Mach L, Rai M (eds) Current Advances in Molecular Mycology. Nova Science Publishers, Inc., New York, pp 107–138
- Yoshizawa T, Morooka N (1973) Deoxynivalenol and its monoacetate. New mycotoxins from *Fusarium roseum* and moldy barley. Agric Biol Chem 37:2933–2934
- Zhang J-B, Li H-P, Dang F-J, Qu B, Xu Y-B, Zhao C-S, Lia Y-C (2007) Determination of the trichothecene mycotoxins chemotypes and associated geographical distribution and phylogenetic species of the *Fusarium graminearum* clade from China. Mycol Res 111:967–975

## Chapter 9

# Molecular Characterization and Diagnosis of *Macrophomina phaseolina*: A Charcoal Rot Fungus

Bandamaravuri Kishore Babu, Ratul Saikia, and Dilip K. Arora

**Abstract** *Macrophomina phaseolina* is a global pathogen that inflicts losses on many agriculturally important crops worldwide, particularly in warm and tropical environments. Efforts to divide *M. phaseolina* into subspecies have been unsuccessful largely due to the extreme intraspecific variations in morphology and pathogenicity. The failure to adequately identify and detect *M. phaseolina* using conventional culture-based morphological techniques has led to the development of nucleic acid-based molecular approaches. PCR-based methods are highly sensitive and specific and have the potential to replace traditional technologies. Recently, species-specific oligonucleotide primers and digoxigenin (DIG)-labeled probe were designed at internal transcribed spacer (ITS) region for identification and detection of *M. phaseolina*. Accurate diagnosis and early detection of pathogens is an essential step in agriculture and environmental monitoring including plant disease management. The main objective of this review is to outline various molecular tools used for detection, identification, and characterization of *M. phaseolina* isolates. We also emphasize the significance of advanced technique such as real-time polymerase chain reaction (PCR) for qualitative and quantitative assays.

---

B.K. Babu

Environmental Microbiology Lab, Department of Environmental Engineering, Chosun University, Gwang ju-501759, South Korea  
e-mail: kishore\_bandam@yahoo.co.in

B.K. Babu and D.K. Arora

National Bureau of Agriculturally Important Microorganisms (ICAR), Mau, Uttar Pradesh 275101, India  
e-mail: aroradilip@yahoo.co.in

R. Saikia

Biotechnology Division, North-East Institute of Science & Technology (CSIR), Jorhat 785006, Assam, India  
e-mail: rsaikia19@yahoo.com



## 9.1 Introduction

*Macrophomina phaseolina* (Tassi) Goid. is a primarily soilborne pathogen with wide distribution, varied host range, greater longevity, and higher competitive saprophytic ability (Chattanaver et al. 1988; Das 1988; Singh et al. 1988; Sobti and Bansal 1988; Abbaiah and Satayanarayan 1990; Das and Sankar 1990; Osunlaja 1990; Singh et al. 1990; Srivastava and Singh 1990; Kaur and Mukhopadhyay 1992; Siddiqui and Mahmood 1992; Mukherjee 1993). About 500 plant diseases are caused by the fungus (Su et al. 2001). The fungus is also associated with seeds and it has been shown that infection leads to both pre- and postemergence mortality, causing seed-to-seedling transmission of the pathogen (Pun et al. 1998). The pathogen occurs both inter- and intracellularly. The amount of internal inoculum is directly related with the degree of symptoms expressed (Sharma and Singh 2000). The pathogen attacks the root system of the plants and causes dissolution of all tissues except the xylem. Wilting followed by withering and death of aerial parts are characteristic symptoms of the disease (Edmunds 1964). The infected roots have abundant mycelia and sclerotia, but rarely pycnidia are produced on infected roots (Knox-Davies 1967). Both pycnidiospores and sclerotia have been implicated in the propagation of this fungus. The pathogen is plurivorous, causing ashy stem and blight or charcoal rot; root and stem show destruction of the cortex. The fungus is also the causal agent of the charcoal rot disease of many crops (Mihail 1992). In some cases, as in histological sections of roots infected with *M. phaseolina* showed destroyed cortical parenchyma, both giant cell and also cortical were invaded by mycelia (Suárez et al. 1998). Inhibition of penetration through the outer cell wall of the upper epidermis may be attributable to an osmophilic layer below the cell wall. Disruption of the host cell walls and subsequent host cell death were preceded by massive colonization of the host (Joye and Paul 1992).

In this chapter, we will provide up-to-date information for the detection and identification of *M. phaseolina*. We will also discuss on molecular markers that have detected a wide range of genetic variations among the isolates.

## 9.2 Classification and Nomenclature

*Macrophomina phaseolina* belongs to subdivision Duteromycotina, class Coelomycetes (Mihail 1992), order Sphaeropsidales, family Sphaerioidaceae, and genus *Macrophomina*. The genus *Macrophomina* contains only one species: *phaseolina* (Sutton 1980).

The successive changes in nomenclature led to confusion in adopting the correct name of *Macrophomina*. The monotypic genus *Macrophomina* was established by Petrak (1923) as *M. philippinensis*. Subsequently, Ashby (1927) examined the type material of this fungus, compared it with several other genera, and established earlier binomial for the fungus as *Macrophomina phaseoli* Maubl. Consequently,

Ashby proposed the combination *M. phaseoli* (Maubl.) (Ashby) for *M. phaseoli* Maubl. and relegated the synonym *M. cajani* P. Syd. and Butler, *M. chorchori* Sawada, *M. sesami* Sewada, *M. philippinensis* Petrak, *Sclerotium bataticola* Taub., *Rhizoctonia bataticola* (Taub.) Butler, and *Dothiorella cajani* (P. Syd. and Butler) Petrak and H. Syd. Goidanich (1947) reviewed the taxonomy of *Macrophomina*. Petrak (1923) named this as *M. phaseolina* Tassi. in place of *M. phaseoli* Maubl. From 1947 onwards, the two names i.e., *M. phaseoli* (Maubl.) (Ashby) and *M. phaseolina* (Tassi.) Goid, became well established in psychopathological literature as the cause of charcoal rot of several important crop plants. After 1977, several other names were suggested for the fungus and ultimately *Macrophomina phaseolina* (Tassi.) Goid was accepted as the correct name (CMI description of pathogenic fungi and bacteria no. 275). The sclerotial phase of *M. phaseolina* is known as *R. bataticola* (Thakurji 1979; Punithalingam 1982).

### 9.3 Identification and Characterization

The biggest problem before mycologists/plant pathologists is to identify/detect thousands of different isolates of this fungus from the cultures in infected roots, soil, and seed lots. Identification and detection of *M. phaseolina* is very difficult because the isolates are morphologically very similar. Different scientists have adopted different methods to distinguish *M. phaseolina* isolates. Among the methods that are most applicable are (1) morphological and cultural characterization, (2) biochemical methods, and (3) polymerase chain reaction (PCR) based molecular techniques.

#### 9.3.1 Morphological and Cultural Characteristics

*M. phaseolina* forms black colonies on potato dextrose agar (PDA) medium, and grows profusely at temperatures ranging from 15 to 40°C. However, the optimum growth occurs at 30–35°C. Some of the isolates can be identified on the basis of morphological characteristics and their thermophilic nature (Satto et al. 1999). The shape of the sclerotia, in most cases, is irregular except for a few which are round to oblong (Mandal et al. 1998). The mycelium is septate, 1.5–2.5 µm wide, hyaline at first turning to honey or black color. Fructification consists of globose or subglobose pycnidium, which is formed only on infected plants and consists of 3–4 layers of blackish-brown, thin-walled angular cells and sclerotia. Pycnidia can be detected in epidermis. Sclerotia are black, and their size on infected plants as well as on media is variable. Under laboratory conditions, sclerotium is hyaline to light brown in color measuring 89 µm in diameter, whereas in soil it measures from 50 to 120 µm in diameter (Upadhayay et al. 2002).

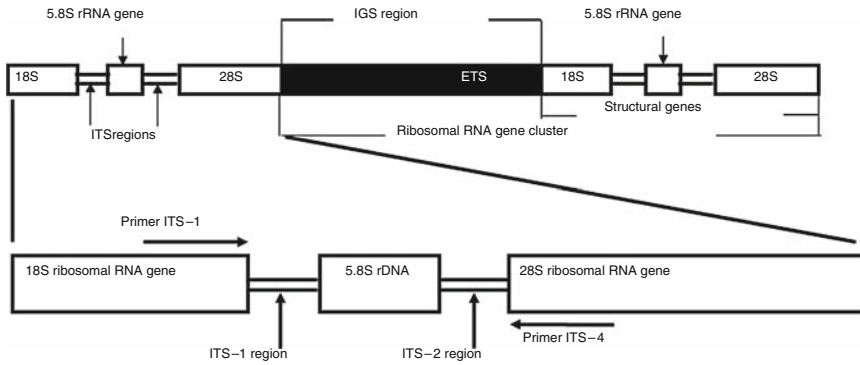
Insufficient morphological variability within the genus has led some workers to partition this fungus on the basis of cultural characteristics (Reichert and Hellinger 1947). Chromogenicity, sporulation ability, and pycnidial size are also known to diverge greatly (Crall 1948; Dhingra and Sinclair 1978; Pearson 1982). Traits with less variability would be more useful when trying to group the isolates. Different investigators have differentiated strains of this fungus on the basis of their ability to utilize nitrate as a nitrogen source (Correll et al. 1986; Correll et al. 1987; Larkin et al. 1988; Bayman and Cotty 1989). *M. phaseolina* have three types of growth patterns, viz., dense, feathery, and restricted, on chlorate-containing minimal medium (120 mM potassium chlorate). Earlier it was found that the utilization of chlorate was used as a marker for identifying host-specific isolates in *M. phaseolina* (Pearson et al. 1986; Cloud and Rupe 1991). Recent studies on the mechanism of chlorate assimilation and genetic basis for chlorate sensitivity have found no correlation with host specificity. It was also observed that chlorate-sensitive isolates were distinct from chlorate-resistant isolates within a given host (Su et al. 2001; Das et al. 2008). Therefore, the chlorate phenotype might not be useful for studying host specialization in *M. phaseolina*.

### 9.3.2 *Biochemical and Serological Characterization*

Biochemical methods such as protein electrophoresis as well as fatty acid and isozyme profiles have also been applied for the characterization and differentiation of fungal taxa (Buth 1984; Faris et al. 1986). Immunological methods are highly specific and sensitive, which may provide a possible solution for detection and quantification of plant pathogenic fungi (Kitagawa et al. 1989; Eparvier and Alabouvette 1994; Jamaux and Spire 1994) and are reliable as quantitative techniques for ecological studies (Balesdent et al. 1995). However, there are no considerable reports on the use of biochemical as well as serological techniques to detect and quantify *M. phaseolina*. Srivastava and Arora (1997) have described a double-antibody sandwich enzyme-linked immunosorbent assay (DAS-ELISA) technique using polyclonal antisera raised from soluble mycelial protein, cell wall proteins, and ribosomal proteins. Polyclonal antibodies that rose from soluble and cell wall protein found no significant polymorphism within the isolates of *M. phaseolina*. Ribosomal-specific antibodies detected in *M. phaseolina* at infected chickpea roots and use of these ribosomal-specific antibodies for the detection of *M. phaseolina* take place under some particular environmental conditions only. Therefore, this technique was limited to taxonomic identification and detection of *M. phaseolina*.

### 9.3.3 *Molecular Methods for Characterization of M. phaseolina*

In recent years, there has been immense progress in the development of molecular biological tools and technologies. These have been increasingly applied to the study



**Fig. 9.1** General Physical map of rDNA gene cluster in fungal genome: The complete repeat unit is represented with genes location and spacer regions. *ITS* Internal transcribed spacers; *IGS* Intergenic spacers. primers ITS-1 and ITS-4 are showing the specific binding position

of fungal plant pathogens (Leong and Holden 1989; Bridge and Arora 1998). The DNA sequences that encode for RNAs have been extensively used to study the taxonomic relationships and genetic variations in fungi (Bruns et al. 1992; Hibbert 1992). The ribosomal RNA gene cluster is found both in nucleus and mitochondria, and consists of both highly conserved and variable regions (White et al. 1990).

The fungal nuclear rRNA genes are arranged as tandem repeats with several hundred copies per genome. The conserved sequences found in the large subunit and small subunit genes have been exploited to study the many relationships among distantly related fungi (Gaudet et al. 1989; Bowman et al. 1992; Bruns et al. 1992). The spacer regions between the subunits, called the internal transcribed spacers (ITS), and between the genes clusters, called the intergenic spacers (IGS), are considerably more variable than the subunit (Fig. 9.1). These genes have been used widely for studies on the relationships among species within a single genus or among interspecific populations (O'Donnel 1992; Molina et al. 1993; Li et al. 1994; Buscot et al. 1996; Arora et al. 1996; Singh et al. 2006).

### 9.3.3.1 Molecular Tools Used for Characterization of *M. phaseolina*

#### Restriction Fragment Length Polymorphism

Though there are many examples of the use of restriction fragment length polymorphism (RFLP) of spacer regions for discriminating between closely related species within a fungal genus, in the case of *M. phaseolina* the ITS region has shown no variations among isolates in restriction patterns of DNA fragments amplified by PCR covering the ITS region, 5.8S rRNA and part of 25S rRNA (Su et al. 2001; Babu et al. 2007). However, Purkayastha et al. (2006) found some degree of polymorphism in restriction patterns of the ITS region, including part of 25S

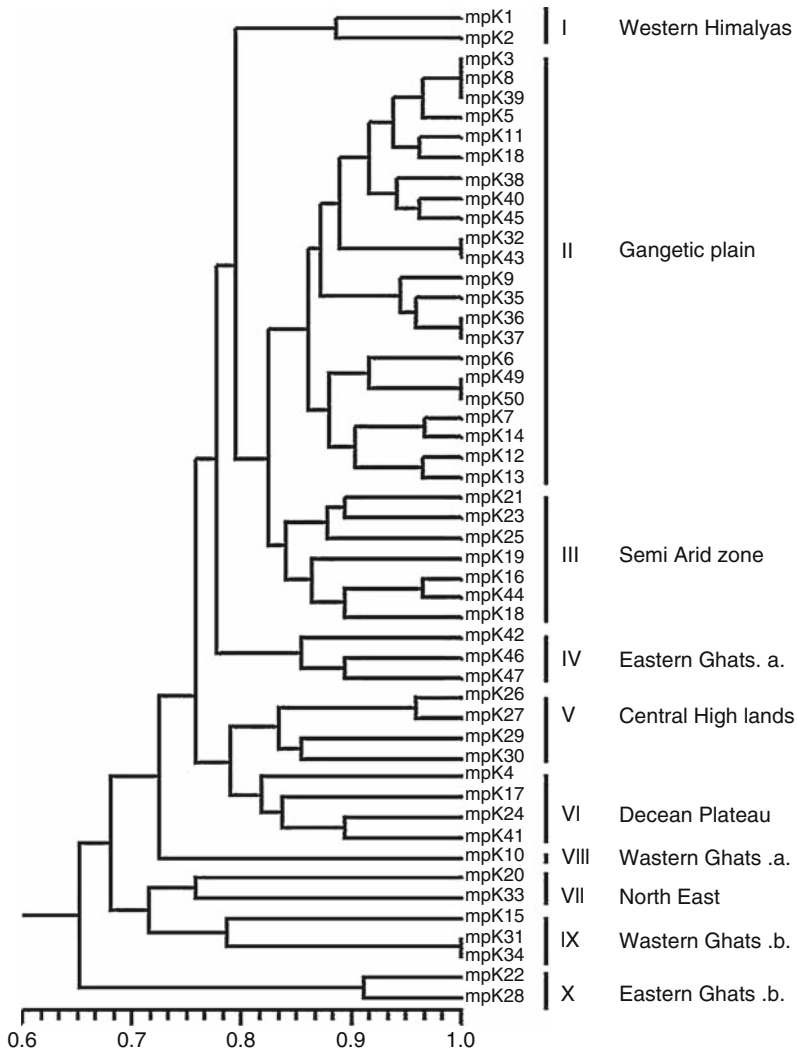
rDNA, indicating the RFLP analysis was not suitable for detection of genetic diversity of *M. phaseolina*.

### PCR-Fingerprinting Techniques

Molecular fingerprinting techniques such as amplified fragment length polymorphism (AFLP), restriction fragment length polymorphism, random amplified polymorphic DNA (RAPD), and simple sequence repeats (SSR) have been used to unveil genetic variability in this soilborne filamentous fungi. Various studies have been devoted to the genetic diversity and pathogenic variability of *M. phaseolina*; however, only a single species has been recognized in the genus *Macrophomina*, but high levels of variation in pathogenicity have been observed (Mayek-Pérez et al. 2001; Su et al. 2001). Jana et al. (2003) developed taxonomic markers for population studies by using a single RAPD primer that distinguishes isolates of *M. phaseolina* from soybean, sesame, ground nut, chickpea, cotton, common bean, and 13 other hosts. The genetic diversity of *M. phaseolina* could favor its survival and adaptation to variable environments because of significant morphological (Mayek-Pérez et al. 1997), physiological (Mihail and Taylor 1995), pathogenic, and genetic (Chase et al. 1994; Vandemark et al. 2000; Mayek-Pérez et al. 2001; Pecina-Quintero et al. 2001; Su et al. 2001; Alvaro et al. 2003; Jana et al. 2003, 2005a, b) diversity. However, there is no clear evidence to suggest formae specialis, or subspecies. Recently, sorghum isolates of Indian origin were distinguished on the basis of chlorate sensitivity (Das et al. 2008). The correlation between genotype and geographical or biological origin was obtained with single RAPD marker among the Indian isolates of *M. phaseolina* collected from different hosts and various agroclimatic zones (Babu et al. 2009a). The Unweighted Pair Group Method with Arithmetic mean (UPGMA) dendrogram obtained by 10-mer random primer OPB-08 separated 50 isolates physiological races has into 10 groups at 65–80% similarity (Fig. 9.2). The 10 clusters correlated well with the geographical locations, with exceptions for isolates obtained from Eastern Ghats (IV and X) and Western Ghats (VIII and IX) and Western Ghats (Fig. 9.2). There was a segregation of isolates from these two geographical locations into two clusters, thus distributing 10 genotypes into 8 geographical locations. The presence of two monomorphic bands suggests that the isolates might have evolved from a common ancestor but due to geographical isolation followed by natural selection and genetic drift they might have segregated into subpopulations (Babu et al. 2009a). Similarly, Reyes-Franco et al. (2006) reported significant variations among the pathotypes obtained from different continents.

#### 9.3.3.2 Diagnostic Tools Developed for Identification and Detection

Molecular methods have recently been described to resolve genetic variation among the isolates of *M. phaseolina* (Das et al. 2008; Jana et al. 2005a, b;



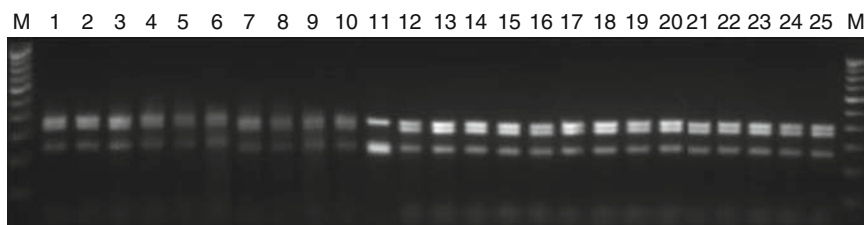
**Fig. 9.2** UPGMA-SAHN clustering dendrogram constructed by the data obtained from the primer OPB-8 in RAPD assay of *Macrophomina phaseolina* isolates labeled as 1–50 mpk. Geographical clusters I to X. Scale in the dendrogram shows the genetic similarity coefficient calculated according to Jaccard (1908). (Taken from Babu et al. 2009a)

Purkayastha et al. 2006). These techniques are useful for grouping of isolates rather than their identification. Oligonucleotide-specific primers or probes targeting the ITS region have been reported to selectively detect several agriculturally important fungi such as *Trichoderma*, *Hypocrea* (Irina et al. 2005), *Fusarium* (Edel et al. 2000), *Verticillium* (Nazar et al. 1991), and *Phytophthora* (Lee et al. 1993). The most interesting thing about *Macrophomina* is that it has only one species (Sutton

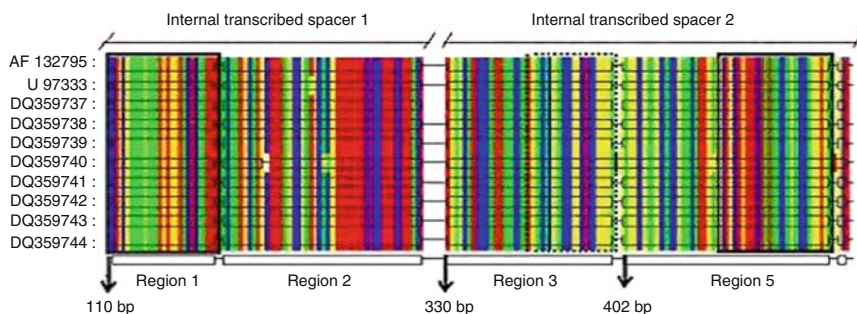
1980) but thousands of isolates. However, the screening of the GenBank for ITS sequences revealed the existence of very few sequences that showed some degree of variation among the isolates. Sequence variation in the rRNA genes may allow the use of these genes as targets for differential amplification.

### PCR-Based Identification

ITS-RFLP of *M. phaseolina* could not detect variations within the different isolates (Su et al. 2001, Babu et al. 2007) (Fig. 9.3). Sequencing and alignment of eight isolates collected from different hosts and diverse ecological conditions, along with two sequences from the GenBank, revealed various conserved and variable regions in the ITS sequences. For a better understanding of these regions, the amplified ITS sequence was virtually divided into five regions (Fig. 9.4). Region 4 (not depicted in



**Fig. 9.3** RFLP analysis of ITS region digested with *HpaI* showing similar restriction pattern with different *Macrophomina phaseolina* isolates (Taken from Babu 2008)



**Fig. 9.4** Development of specific oligonucleotide primers and probe: Alignment of ITS-1 and ITS-2 sequences from eight isolates of *Macrophomina phaseolina* and two reference sequences (AF132795 and U97333) from GenBank database. Nucleotides are shown as color bars (A-red, G-yellow, T-blue and C-green). Regions 1, 2, 3 and 5 are completely aligned, 5.8S RNA gene is not shown and the region 4 omitted because of the variability. Solid line rectangles indicate specific nucleotide areas used for the development of specific oligonucleotide primers and the dashed ones show the specific region used for probe designing. The position of the first nucleotide of region 1 and others are according to the reference sequence AF132795 (Taken from Babu et al. 2007)



**Table 9.1** Species-specific oligonucleotides

Sl. No.	Primer/Probe	Sequence
1	MPKF1 (primer)	5'-CCG CCA GAG GAC TAT CAA AC-3'
2	MPKR1 (primer)	5'-CGT CCG AAG CGA GGT GTA TT-3'
3	MPKH1 (probe)	5'-GCT CTG CTT GGT ATT GGG C-3'

the figure) was deleted, as it contained sequences that showed variations among the isolates of *M. phaseolina*. Further sequence alignment with other closely related genera of soilborne fungi helped to identify two regions that were conserved among *Macrophomina* isolates but exhibited a high degree of variability among isolates of other genera. The two primers designed from these selected regions of ITS showed specificity in the PCR assay. Optimization of the PCR conditions and validation of primers yielded a specific 350-bp amplicon for *M. phaseolina* isolates. The absence of the 350-bp product in other species of soilborne fungi, bacteria, and actinomycetes confirmed that the primers can be utilized to selectively and specifically identify *M. phaseolina*. Thus PCR assays with primers MpKR1 and MpKF1 could be used to rapidly identify *M. phaseolina*.

#### Hybridization Probes

Further, species-specific oligonucleotide probe MpKH1 was also designed within the ITS region (Table 9.1) (Babu et al. 2007). The DIG-labeled probe could detect the target sequences at varying concentrations with little or no background. The probe was also shown to be specific for *M. phaseolina* and no signals were obtained with nonspecific target ITS sequences (Fig. 9.4). Though the probe would be a good diagnostic tool for the detection within the PCR-amplified product of pure cultures, in direct field detection with soil DNA it had shown false-positive signal and nonspecific binding with closely related species (Babu 2008). Therefore, hybridization assays developed for *M. phaseolina* based on ITS region have been limited to certain specific conditions.

### 9.4 Recent Developments in the Diagnostics of *M. phaseolina*

Previously, we demonstrated molecular identification and detection tools for *M. phaseolina* (Babu et al. 2007) in which rDNA gene cluster had been selected as a target for designing of specific primers and probe. Even though primers were showing greater specificity, hybridization assay using DNA probe was not always sensitive because of its small size (20 bp). Furthermore, like post-PCR analysis, dot-blot techniques are very time-consuming and require additional skills. The diagnostic technique has greatly improved by the introduction of real-time PCR technology based on fluorescence detection and quantification during PCR



amplification. Modern quantitative (qPCR) technology employing either nonspecific fluorogenic DNA-binding dyes, such as SYBR Green, or sequence-specific fluorogenic hybridization probes, such as TaqMan (Cook and Schlitzer 1981; Guiver et al. 2001) detection chemistry, has been described for a range of plant pathogens (Falcao et al. 1993; Widjoatmodjo et al. 1999; Arvanitidou et al. 2000; Hao-Zhi and Ruey 2006) including assays for the detection both in the laboratory (Doggett 2000; Stultz et al. 2001) and in the field (Spencer and Spencer 1997). Therefore, recently we developed real-time qPCR assay to quantify *M. phaseolina* abundance in soils and plants by using TaqMan and SYBR Green assay techniques. The techniques were targeting on ~1 kb sequence characterized amplified region (SCAR) of *M. phaseolina*, and two sets of specific primers were designed for SYBR green (MpSyK) and TaqMan (MpTqK) assays. Both the assays were reproducible and accurately quantified *M. phaseolina* population in soils and plant samples. No cross hybridization and no increasing fluorescent signal exceeding the baseline threshold were observed with the tested microbes, except when *M. phaseolina* DNA was used as template. Limit of quantification (LOQ) of *M. phaseolina* DNA in sclerotial suspension was calculated as 200 pg/ $\mu$ l equivalent to 1 ng, which is equivalent to  $2 \times 10^4$  CFU  $g^{-1}$  per soil. Further, we demonstrated the application of a species-specific real-time qPCR assay useful for the detection of *M. phaseolina* population in soil (Babu et al. 2009b).

## 9.5 Future Prospects

Sequence data in public databases are constantly increasing; as a result, integration of more strains into detection systems of *M. phaseolina* will become possible, and identification of this pathogen is likely to become an easier task which would also help current detection and characterization methods. The resulting database will allow the complete analysis of developmental processes that are characteristics of the fungus, including the molecular nature of pathogenicity. Like some other phytopathogenic fungi, in the next few years complete genome sequences might be available for *M. phaseolina* also, and a combination of DNA microarrays with other genomic methods will certainly accelerate the effort to characterize this fungus. The escalating effect of biology, bioinformatics, and genomics may facilitate tracing out *M. phaseolina* genetic resources and their potential application in disease management also.

## 9.6 Conclusion

In this review, an overview of our current knowledge regarding the biology of *M. phaseolina* with emphasis on diagnosis is given. Although several attempts have been made to examine the pathogenic and genetic variability of the species, further

work is needed to clarify, for example, the adaptability to multiple hosts and the validity of species evolution in the genus *Macrophomina*. Similarly, our knowledge on the PCR identification and hybridization assays for detection has been enhanced. Therefore, further studies should be pursued to quantify the population of this important plant pathogen in the field. Besides, diagnosis genes involved in the pathogenesis and characterization of host-specific toxins would hasten efficient breeding and the development of resistance traits.

**Acknowledgment** The work is supported by a Network Project, sponsored by Indian Council of Agricultural Research (ICAR), Government of India, New Delhi. The authors are thankful to the funding agency.

## References

- Abbaiah K, Satyanarayan A (1990) Stem canker on black gram (*Vigna mungo*) in Andhra Pradesh. Indian J Plant Protect 18:136
- Alvaro MRA, Ricardo VA, Carlos AAA, Valdemar PC, David SJF, Silvana RRM, Luis CB, Mauro CP, Claudio GPC (2003) Genotypic diversity among Brazilian isolates of *Macrophomina phaseolina* revealed by RAPD. Fitopatol Brasil 28:279–285
- Arora DK, Hirsch PR, Kerry BR (1996) PCR-based molecular discrimination of *Verticillium chlamydosporum* isolates. Mycol Res 100:801–809
- Arvanitidou M, Spaia S, Velegraki A, Pazaroglou M, Kanetidis D, Pangidis P, Askepidis N, Katsinas C, Vayonas G, Katsouyannopoulos V (2000) High level of recovery of fungi from water and dialysate in haemodialysis units. J Hosp Infect 45:225–230
- Ashby SF (1927) *Macrophomina phaseolina* (Maubl.) Comb. Nov. The pycnidial stage of *Rhizoctonia bataticola* (Taub.). Butl Trans Br Mycol Soc 12:141–147
- Babu KB (2008) Genomic fingerprinting and development of molecular probes for identification and detection of *Macrophomina phaseolina*. Ph.D. Thesis, Bundelkhand University, India
- Babu KB, Srivastava AK, Saxena AK, Arora DK (2007) Identification and detection of *Macrophomina phaseolina* by using species-specific oligonucleotide primers and probe. Mycologia 99:733–739
- Babu KB, Reddy SS, Sukumar M, Arora DK (2009b) SCAR derived, Quantitative Real-Time PCR assay for enumeration of phytopathogenic fungi - *Macrophomina phaseolina*. Appl Environ Microbiol. unpublished data
- Babu KB, Reddy SS, Yadav KM, Sukumar M, Mishra V, Saxena AK, Arora DK (2009a) Geo-diversity among Indian isolates of *Macrophomina phaseolina* by using RAPD marker. Indian J Microbiol (In press)
- Balesdent MH, Destheux C, Gall PR, Rouxel T (1995) Quantification of *Leptosphaeria maculans* growth in cotyledons of *Brassica napus* using ELISA. J Phytopathol 143:65–73
- Bayman P, Cotty PJ (1989) Vegetative compatibility groups in *Aspergillus flavus*. Phytopathology 79:1186 (Abstr.)
- Bowman BH, Taylor JW, Browlee AG, Lee J, Lu S, White TJ (1992) Molecular evolution of the fungi: relationship of basidiomycetes and chytridiomycetes. Mol Biol Evol 9:285–296
- Bridge PD, Arora DK (1998) Interpretation of PCR methods for species definition. Application of PCR in mycology. CAB International, pp 63–84
- Bruns TD, Vilgalys R, Barns SM, Gonzalez D, Hibbert DS, Lane DJ, Simon LS, Szaro TM, Weisburg WG, Sogin ML (1992) Evolutionary relationships within fungi: analysis of nuclear small subunit rRNA sequences. Mol Phyl Evol 1:231–241

- Buscot F, Wipf D, Di Battista C, Munch JC, Botton B, Martin F (1996) DNA polymorphism in molds: PCR-RELP analysis of the ribosomal DNA spacers and microsatellite-primed PCR. *Mycol Res* 100:63–71
- Buth DG (1984) The application of electrophoretic data in systematic studies. *Annu Rev Ecol Syst* 15:501–522
- Chase TE, Jiang Y, Mihail JD (1994) Molecular variability in *Macrophomina phaseolina*. *Phytopathology* 84:1149
- Chattanaver SN, Adiver SS, Nargound VB, Rao SS, Kulkarni S (1988) Laboratory evaluation of fungicide against *Rhizoctonia bataticola* causing root rot of Casuarina. *Curr Res* 17:160–161
- Cloud GL, Rupe JC (1991) Morphological instability in a chlorate medium of isolates of *Macrophomina phaseolina* from soybean and sorghum. *Phytopathology* 81:892–895
- Cook WL, Schlitzer RL (1981) Isolation of *Candida albicans* from freshwater and sewage. *Appl Environ Microbiol* 41:840–842
- Correll JC, Puhalla JE, Schneider RW (1986) Identification of *Fusarium oxysporum* f.sp.*apii* on the basis of colony size, virulence, and vegetative compatibility. *Phytopathology* 76:396–400
- Correll JC, Klittich CJR, Leslie JF (1987) Nitrate nonutilizing mutants of *Fusarium oxysporum* and their use in vegetative compatibility tests. *Phytopathology* 77:1640–1666
- Crall JM (1948) Charcoal rot of soybean caused by *Macrophomina phaseoli* (Maubl.) Ashby. Ph. D. dissertation, University of Missouri, Columbia, p 148
- Das ND (1988) Effect of different sources of carbon, nitrogen and temperature on growth and sclerotial production of *Macrophomina phaseolina* (Tassi) Goid, causing root rot/charcoal rot disease of castor. *Indian J Plant Pathol* 6:97–98
- Das ND, Sankar GRM (1990) Effect of root rot disease caused by *Macrophomina phaseolina* Tassi (Goid). Of castor (*Ricinus comunis*) by statistical modeling of cultural practices of carbendazim applications. *Indian J Mycol Plant Pathol* 20:234–240
- Das IK, Fakrudin B, Arora DK (2008) RAPD cluster analysis and chlorate sensitivity of some Indian isolates of *Macrophomina phaseolina* from sorghum and their relationships with pathogenicity. *Microbiol Res* 163:215–224
- Dhingra OD, Sinclair JB (1978) Biology and pathology of *Macrophomina phaseolina* Vicosia. *Imprensia Universitaria, Universidade Federal de Vicosia, Brazil*, pp 166
- Doggett MS (2000) Characterization of fungal biofilms within a municipal water distribution system. *Appl Environ Microbiol* 66:1249–1251
- Edel V, Steinberg C, Gautheron N, Alabouvette C (2000) Ribosomal DNA-targeted oligonucleotide probe and PCR assay specific for *Fusarium oxysporum*. *Mycol Res* 104:518–526
- Edmunds LK (1964) Combined relation of plant maturity, temperature, and soil moisture to charcoal stalk rot development in grain sorghum. *Phytopathology* 54:514–517
- Eparvier A, Alabouvette C (1994) Use of ELISA and GUS-transformed strains to study competition between pathogenic and non-pathogenic *Fusarium oxysporum* for root colonization. *Biocont Sci Technol* 4:35–47
- Falcao DP, Leite CQF, Simoes MJS, Giannini MJSM, Valentini SR (1993) Microbial quality of recreational waters in Araraquara, SP, Brazil. *Sci Total Environ* 128:37–49
- Faris MA, Sabo FE, Cloutier Y (1986) Intraspecific variation in gel electrophoresis patterns of soluble mycelial proteins of *Phytophthora megasperma* isolated from alfalfa. *Can J Bot* 64:262–265
- Gaudet J, Julien J, Lafay JF, Brygoo Y (1989) Phylogeny of some *Fusarium* species, as determined by large subunits rRNA sequence comparison. *Mol Biol Evol* 6:227–242
- Goidanich (1947) Differential responses of *Guayule* (*Parthenium arginatum gray*) genotypes to sulture filtrate and toxin from *Macrophomina phaseolina* (Tassi) Goid. *Kuti. Jo; Schading RL, Latigo GC, Bradfold JM. Phytopathologisete Zeitschrift* 145(7):305–311
- Guiver M, Levi K, Oppenheim BA (2001) Rapid identification of *Candida* species by TaqMan PCR. *J Clin Pathol* 54:362–366
- Hao-Zhi Y, Ruey FL (2006) Selection of internal control genes for real-time quantitative RT-PCR assays in the oomycete plant pathogen *Phytophthora parasitica*. *Fungal Genet Biol* 43:430–438

- Hibbert DS (1992) Ribosomal RNA and fungal systematics. *Trans Mycol Soc Jpn* 33:533–556
- Irina SD, Alexei GK, Monika K, John B, George S, Christian PK (2005) An oligonucleotide barcode for species identification in *Trichoderma* and *Hypocrea*. *Fungal Genet Biol* 42:813–828
- Jaccard P (1908) Nouvelles recherches sur la distribution florale. *Société Vaudoise des Sci Naturelles Bull* 44:223–70
- Jamaux I, Spire D (1994) Development of polyclonal antibody based immunoassay for the early detection of *Sclerotinia sclerotium* in rapeseed petals. *Plant Pathol* 43:847–862
- Jana TK, Sharma TR, Prasad RD, Arora DK (2003) Molecular characterization of *Macrophomina phaseolina* and *Fusarium* species by a single primer RAPD technique. *Microbiol Res* 158:249–257
- Jana TK, Sharma TR, Singh NK (2005a) SSR-based detection of genetic variability in the charcoal root rot pathogen *Macrophomina phaseolina*. *Mycol Res* 109:81–86
- Jana TK, Singh NK, Koundal KR, Sharma TR (2005b) Genetic differentiation of charcoal rot pathogen, *Macrophomina phaseolina*, in to specific groups using URP-PCR. *Can J Microbiol* 51:159–164
- Joye GF, Paul RN (1992) Histology of infection of *Hydrilla verticillata* by *Macrophomina phaseolina*. *Weed Sci* 40:288–295
- Kaur NP, Mukhopadhyay AN (1992) Integrated control of chickpea wilt complex by *Trichoderma* and chemical methods in India. *Trop Pest Manag* 38:372–375
- Kitagawa T, Sakamoto Y, Furumi K, Ogura H (1989) novel enzyme immunoassay for specific detection of *Fusarium oxysporum* F.sp. *cucumerinum* and for general detection of various *Fusarium* species. *Phytopathology* 79:162–165
- Knox-Davies PS (1967) Mitosis and aneuploidy in the vegetative hyphae of *Macrophomina phaseolina*. *Am J Bot* 54:1290–1295
- Larkin RP, Hopkins DL, Martin FN (1988) Differentiation of strains and pathogenic races of *Fusarium oxysporum* F.sp. *niveum* based on vegetative compatibility. *Phytopathology* 78:1542 (Abstr.)
- Lee SB, White TJ, Taylor JW (1993) Detection of *Phytophthora* species of oligonucleotide hybridization to amplified ribosomal DNA spacers. *Phytopathology* 83:177–181
- Leong SA, Holden DW (1989) Molecular genetic approaches to the study of fungal pathogenesis. *Annu Rev Phytopathol* 27:463–481
- Li KN, Rouse DI, German TL (1994) PCR primers that allow intergeneric differentiation of ascomycetes and their application to *Verticillium* spp. *Appl Environ Microbiol* 60:4324–4331
- Mandal R, Sinha MK, Ray MKG, Mishra CBP, Chakrabarty NK (1998) Variation in *Macrophomina phaseolina* (Tassi) Goid causing stem rot of jute. *Environ Ecol* 16:424–426
- Mayek-Pérez N, López-Castañeda C, Acosta-Gallegos JA (1997) Variación en características culturales *in vitro* de aislamientos de *Macrophomina phaseolina* y su virulencia en frijol. *Agrociencia* 31:187–195
- Mayek-Pérez N, Lopez-caataneda C, Gonzalez-Chavira M, Garch-Espinosa R, Acosta-Gallegos J, de la Vega OM, Simpson J (2001) Variability of Mexican isolates of *Macrophomina phaseolina* based on pathogenesis and AFLP genotype. *Physiol Mol Plant Pathol* 59:257–264
- Mihail JD (1992) In Methods for research on soilborne phytopathogenic fungi. In: Singleton LL, Mihail JD, Rush CM (eds) St Paul, MN, USA, American Phytopathological Society Press, pp 134–136
- Mihail JD, Taylor SJ (1995) Interpreting variability among isolates of *Macrophomina phaseolina* in pathogenicity, pycnidium production and chlorate utilization. *Can J Bot* 10:1596–1603
- Molina FI, Jong S, Huffman JL (1993) PCR amplification of the 3 external transcribed and intergenic spacers of the ribosomal DNA repeat unit in three species of *Saccharomyces*. *FEMS Microbiol Lett* 108:259–264
- Mukherjee PK (1993) Biological control of collar rot, dry root rot wilt and gray mold of chickpea. Patancheru AP, India, p 36

- Nazar RN, Hu X, Schmidt J, Culham D, Robb J (1991) Potential use of PCR-amplified ribosomal intergenic sequences in the detection and differentiation of *Verticillium* wilt pathogens. *Physiol Mol Plant Pathol* 39:1–11
- O'Donnel KL (1992) Ribosomal DNA internal transcribed spacers are highly divergent in the phytopathogenic ascomycetes *Fusarium sambucinum* (*Gibberella pulicaris*). *Curr Genet* 22:213–220
- Osunlaja SD (1990) Tillage effects on incidence and severity of root and stalk rot caused by *Macrophomina phaseolina* in South West Nigeria. *J Phytopathol* 130:312–316
- Pearson CAS (1982) *Macrophomina phaseolina* Casual organism of charcoal rot of soybean. I. Laboratory test for resistance. II. Implications of conidia in epidemology. III. Anti microbial activity of toxins. M. Sc. Thesis, Kansas State University, Manhattan, p 59
- Pearson CAS, Leslie JF, Schwenk FW (1986) Variable resistance in *Macrophomina phaseolina* from corn, soybean and soil. *Phytopathology* 76:646–649
- Pecina-Quintero V, Alvarado MJ, Williams-Alanis H, Almaraz RT, Vandemark GJ (2001) Detection of double stranded RNA in *Macrophomina phaseolina*. *Mycologia* 92:900–907
- Petrak F (1923) *Kykologische Notizen VI*. *Anal Mycologicity* 21:314–315
- Pun KB, Sabitha D, Valluvapardasan V (1998) Studies on seed-borne nature of *Macrophomina phaseolina* in okra. *Plant Dis Res* 13:162–164
- Punithalingam E (1982) Conidiation and appendage formation in *Macrophomina phaseolina* (Tassi) Goid. *Nova Hedwigia* 36:249–290
- Purkayastha S, Kaur B, Dilbaghi N, Chaudhary A (2006) Characterization of *Macrophomina phaseolina*, the charcoal rot pathogen of cluster bean, using conventional techniques and PCR-based molecular markers. *Plant Pathol* 55:106–116
- Reichert I, Hellinger E (1947) On the occurrence, morphology and parasitism of *Sclerotium bataticola*. *Palest J Bot* 6:107–147
- Reyes-Franco MC, Hernandez-Delgado S, Beas-Fernandez R, Medina-Fernandez M, Simpson J, Mayek-Pérez N (2006) Pathogenic and genetic variability within *Macrophomina phaseolina* from Mexico and other countries. *J Phytopathol* 154:447–453
- Satto T, Tomioka K, Nakanishi T, Koganezawa H (1999) Charcoal rot of yacon (*Smallanthus sonchifolius* (Poepp. et Endl.) H. Robinson), Oca (*Oxalis tuberosa* Molina) and pearl lupin (Tarwi, *Lupinus mutabilis* Sweet) caused by *Macrophomina phaseolina* (Tassi) Goid. *Bull Shikoku Natl Agri Exp Station* 64:1–8
- Sharma K, Singh T (2000) Seed and seedling infection of *Rhizoctonia bataticola* in *Vigna radiata*. *J Mycol Plant Pathol* 30:15–18
- Siddiqui ZA, Mahmood I (1992) Biological control of root rot disease complex of chickpea caused by *Meloidogyne incognita* race 3 and *Macrophomina phaseolina*. *Nematologia Mediterranea* 20:199–202
- Singh D, Nema KG, Singh D (1988) Effect of soil amendment on *Rhizoctonia bataticola* causing dry root rot of chickpea. *International Chickpea Newslett* 17:23–25
- Singh A, Bhowmik TP, Chaudhary BS (1990) Effect of soil amendment with inorganic and organic sources of nitrogenous manures on the incidence of root rot and seed yield in sesamum. *Indian Phytopathol* 43:442–443
- Singh BP, Saikia R, Yadav M, Singh R, Chauhan VS, Arora DK (2006) Molecular characterization of *Fusarium oxysporum* f. sp. *ciceri* causing wilt of chickpea. *Afr J Biotechnol* 5:497–502
- Sobti AK, Bansal RK (1988) Cultural variability among three isolates of *R. bataticola* from groundnut. *Indian Phytopathol* 41:149–151
- Spencer JFT, Spencer DM (1997) Ecology: where yeasts are. In: Spencer JFT, Spencer DM (eds) *Yeasts in natural and artificial habitats*. Springer-Verlag, Germany, pp 48–58
- Srivastava AK, Arora DK (1997) Evaluation of a polyclonal antibody immunoassay for detection and quantification of *Macrophomina phaseolina*. *Plant Pathol* 46:785–794
- Srivastava AK, Singh RB (1990) Effect of organic amendment on interaction of *Macrophomina phaseolina* and *Meloidogyne incognita* on fresh bean (*Phaseolus vulgaris*). *New Agric* 1:99–100

- Stultz JR, Snoeyenbos-West O, Methe B, Lovley DR, Chandler DP (2001) Application of the 5' fluorogenic exonuclease assay (TaqMan) for quantitative ribosomal DNA and rRNA analysis in sediments. *Appl Environ Microbiol* 67:2781–2789
- Su G, Suh SO, Schneider RW, Russin JS (2001) Host specialization in the charcoal rot fungus, *Macrophomina phaseolina*. *Phytopathology* 91:120–126
- Suárez ZH, Rosales LC, Rondón A, González MS (1998) Histological alterations on *Psidium guajava* roots caused by the nematode *Meloidogyne incognita* race 1 and the fungi *Macrophomina phaseolina* and *Fusarium oxysporum*. *Fitopatología Venezolana* 11:44–47
- Sutton BC (1980) The coelomycetes: fungi imperfecti with pycnidia, acervuli and stromata. *Commonw Mycol Inst Assoc Appl Biol*, Kew, England, p 696
- Thakurji (1979) Chemical control of *Macrophomina phaseolina* root rot of jute. *Indian Phytopathol* 32:280–281
- Upadhyay RK, Arora DK, Dubey OP (2002) *Indian Pest Management*, vol II. Aditya Books Pvt. Ltd., New Delhi, India, pp 131–147
- Vandemark G, Martnez O, Pecina V, Alvarado M de J (2000) Assessment of genetic relationships among isolates of *Macrophomina phaseolina* using simplified AFLP technique and two different methods of analysis. *Mycologia* 92:656–664
- White TJ, Bruns T, Lee S, Taylor JW (1990) Amplification and direct sequencing of fungal ribosomal RNA genes for Phylogenetics. In: Innis MA, Gelland DH, Sninsky JJ, White TJ (eds) *PCR Protocols: a guide to methods and applications*. Academic Press, San Diego, pp 315–322
- Widjoatmodjo MN, Borst A, Schukkink RAF, Box ATA, Tacken NMM, Van Gemen B, Verhoef J, Top B, Fluit AC (1999) Nucleic acid sequence-based amplification (NASBA) detection of medically important *Candida* species. *J Microbiol Methods* 38:81–90

# Chapter 10

## Molecular Diagnosis of Ochratoxigenic Fungi

Daniele Sartori, Marta Hiromi Taniwaki, Beatriz Iamanaka,  
and Maria Helena Pelegrinelli Fungaro

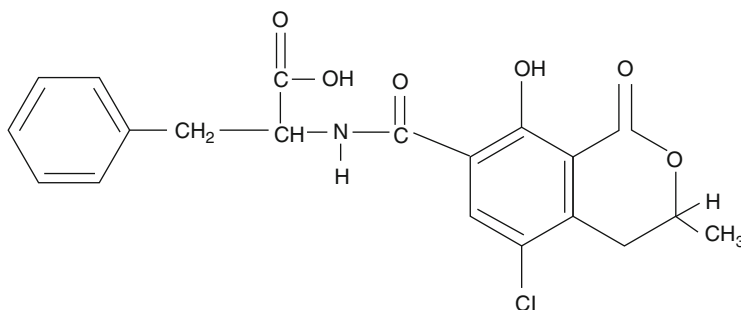
**Abstract** Ochratoxin A (OTA) is one of the most abundant food-contaminating mycotoxins. Its presence in several agricultural commodities has been considered a problem worldwide. This toxin is mainly produced by two genera of fungi: *Aspergillus* and *Penicillium*. Ochratoxin A has nephrotoxic, immunosuppressive, and carcinogenic effects; consequently, contamination with OTA presents a major risk for human and animal health. Over the last 5 years, several studies have developed PCR-based assays for identifying and quantifying OTA-producing fungi in food samples. The main objective of these assays is to allow the detection of microorganisms capable of producing OTA, prior to ochratoxin production and accumulation. Several of these attempts will be reviewed and discussed in this chapter.

### 10.1 Introduction

Filamentous fungi can produce a vast variety of secondary metabolites and are rich in genes that encode proteins involved in their biosynthesis (Khaldi et al. 2008). In contrast to the primary metabolites that are common and of vital importance for all living organisms, secondary metabolites are not necessary for survival and cellular differentiation, and their synthesis is often limited to a single family, genus, species, or even strain of fungus (Bennett and Ciegler 1983). The secondary metabolites include mycotoxins, which are small organic molecules with diverse chemical structures and biological activities. Mycotoxins are toxic compounds that are occasionally very hazardous to animals and humans. The main source of mycotoxin exposure is from consuming plant foods, which can be contaminated during harvesting, transport, storage or manufacture, or even in the field (Smith and

---

D. Sartori, M.H. Taniwaki, B. Iamanaka, and M.H.P. Fungaro  
Centro de Ciências Biológicas, Departamento de Biologia Geral, Universidade Estadual de Londrina, Caixa Postal 6001, CEP 86051-970, Londrina-Paraná, Brazil  
e-mail: fungaro@uel.br



**Fig. 10.1** The chemical structure of ochratoxin A

Henderson 1991). There is a risk to human health not only through the intake of contaminated foods of vegetal source, but also through foods of animal origin due to mycotoxin-contaminated animal feed ingested by animals. Due to the different molecular structures of these mycotoxins, their influences on human and animal health have a variety of effects; they may be neurotoxic, teratogenic, immunosuppressive, nephrotoxic, hepatotoxic, or carcinogenic (Geisen 1998). About 20 different mycotoxins are significant to human health (Geisen 1998; Bennett and Klich 2003), and demand exists for rapid and reliable techniques to detect mycotoxins and mycotoxin producers (Russell and Paterson 2006).

Ochratoxins are a class of mycotoxins produced by some fungal species. There are three types of ochratoxin — A, B, and C — but ochratoxin A (7-(L- $\beta$ -phenylalanyl-carbonyl)-carboxyl-5-chloro-8-hydroxy-3,4-dihydro-3*R*-methyl isocoumarin, or OTA; Fig. 10.1) is the most toxic and is one of the most common food mycotoxins. Although this toxin was described many years ago, it has only recently begun to receive considerable attention (van der Merwe et al. 1965). As reviewed by Petzinger and Weidenbach (2002), OTA-contaminated foods are abundant in several countries. About 57% of approximately 6,500 food samples examined in Europe contained amounts of OTA above the detection limit of 0.01  $\mu\text{g kg}^{-1}$  (Wolff et al. 2000). The most important examples are grains, coffee beans, spices, nuts, grapes, and figs (Bayman et al. 2002; Jorgensen and Jacobsen 2002; Battilani et al. 2003; Taniwaki et al. 2003). OTA is not totally decomposed during most food processing steps such as cooking, washing, and fermenting. Because of this, OTA has also been detected in manufactured food products such as bread, beer, wine, coffee, and chocolate (Jorgensen 1998; Visconti et al. 2001).

Kidneys are the main target organs of OTA. Nephrotoxic effects have been demonstrated in all the mammalian species tested so far. For humans, there is abundant circumstantial evidence connecting OTA ingestion with severe nephropathy (Mantle and McHugh 1993; Maaroufi et al. 1995; Wafa et al. 1998). The carcinogenicity of OTA in rodents is also well established, although in humans a correlation between cancer and exposure to OTA has not been proven directly. Based on these facts, the International Agency for Research on Cancer (IARC 1993) classified OTA as a possible human carcinogen (group 2B) in 1993. More



recent studies have documented significant effects of OTA on immune response. According to Petzinger and Weidenbach (2002), these additional effects have gained increased attention since it was observed that they may occur even at very low concentrations of OTA.

Based on the risk that OTA presents to human health, the European Union has imposed regulations on maximum levels of OTA in cereals and cereal products, dried vine fruit, and all products derived from these items, as well as roasted and soluble coffee. For dried vine fruits (raisins, currants, and sultanas), the maximum tolerable level of OTA is set at  $10 \mu\text{g kg}^{-1}$ ; the maximum level permitted in wines and grapes is  $2 \mu\text{g kg}^{-1}$ . For raw cereal grains and all cereal-derived products for direct human consumption, the maximum tolerable levels of OTA are  $5 \mu\text{g kg}^{-1}$  and  $3 \mu\text{g kg}^{-1}$ , respectively. Finally, the maximum level of OTA in coffee is  $5 \mu\text{g kg}^{-1}$  for both roasted coffee beans and ground coffee and  $10 \mu\text{g kg}^{-1}$  for instant coffee (Official Journal of The European Union, 2005). The European Union is at present considering whether a maximum level for OTA should be established in other foods, such as cocoa.

A particular species of fungus may produce several mycotoxins, but not all fungi produce mycotoxins. In addition, the type and quantity of a certain mycotoxin are associated with specific strains, while environmental conditions and available nutrients are determinants for the growth of the fungus and its mycotoxin production.

The economically most important OTA producers were recently reviewed by Varga and Kozakiewicz (2006): *Penicillium verrucosum* in cereals (Lund and Frisvad 2003); *Aspergillus niger* and *A. carbonarius* in grapes (Battilani and Pietri 2002); *Aspergillus ochraceus*, *A. niger* and *A. carbonarius* in coffee (Bucheli and Taniwaki 2002; Taniwaki et al. 2003), and *Aspergillus alliaceus* in figs (Bayman et al. 2002). However, recent advances in molecular biology and fungal metabolite analysis resulted in the description of some important new OTA-producing species by European researchers (Frisvad et al. 2004). *Aspergillus westerdijkae*, which closely resembles *A. ochraceus*, is now recognized as the main OTA producer in coffee.

The severe consequences of OTA contamination demand efficient and cost-effective methodologies for detecting OTA producers in food. In this chapter, we present some of the relevant molecular approaches that have been used to detect and quantify the main OTA producers in food.

### ***10.1.1 Molecular Markers for the Detection of Ochratoxigenic Fungi***

The traditional schemes for the isolation and identification of ochratoxigenic fungi from food samples are time-consuming and require a high knowledge of fungal taxonomy. Even with taxonomic expertise, identification is commonly difficult in some genera of fungi that contain a large number of closely related species. The application of molecular biology techniques can help to overcome these problems

because it can reduce the time for identification from days to hours and also allow precise species identification. Polymerase chain reaction (PCR) is a technique that was developed in 1985 for the *in vitro* amplification of specific segments of DNA (Saiki et al. 1985; Mullis and Faloona 1987). This technique has allowed the precise identification and fast detection of ochratoxigenic species without the need for isolating pure cultures.

The selection of target sequence specific for a given mycotoxin-producing fungus is a key process in the development of a PCR-based diagnostic assay. These target sequences used for designing PCR primers may be didactically divided into two groups: (a) anonymous DNA sequences and (b) functional genes (Carter and Vetrie 2004). Anonymous DNA sequences are obtained from an unbiased sample of genomic DNA and may or may not contain functional genes. Developing markers from anonymous sequences requires comparative analyses between the DNA profiles of related species generated from randomly amplified fragments by random amplified polymorphic DNA (RAPD) or amplified fragment length polymorphism (AFLP) (Williams et al. 1990; Vos et al. 1995). Both methodologies have proven to be powerful taxonomic instruments, especially at low taxonomic positions. The amplification patterns produced by RAPD and AFLP analysis allow discrimination between species and distinct isolates of a single species. Polymorphisms are recognized by the presence or absence of amplified fragments at each RAPD or AFLP locus. DNA bands that are exclusively present in all isolates of a certain toxigenic species may be cloned and sequenced. Once an RAPD or AFLP marker is sequenced, it can be converted into a robust PCR-based marker. Thus, RAPD and AFLP have been applied successfully for revealing specific marker sequences (Schmidt et al. 2003, 2004b; Fungaro et al. 2004a; Sartori et al. 2006). Such sequences have been used to design species-specific primers that allow the identification and detection of some ochratoxigenic species in food samples.

As mentioned above, the sequences of functional genes may also be used as targets for PCR primers to detect mycotoxigenic fungi. However, in contrast to other mycotoxins, the OTA biosynthetic pathway has not been well characterized in any of the OTA-producing species; consequently, the genes that encode enzymes involved in the biosynthesis of this secondary metabolite are poorly known. Because of this, the several PCR-based assays developed during the last 5 years have used genes that were not associated to mycotoxin biosynthesis: ribosomal RNA,  $\beta$ -tubulin, and calmodulin genes (Perrone et al. 2004; Patiño et al. 2005; Morello et al. 2007).

### ***10.1.2 PCR-Detection and Quantification of Ochratoxigenic Species with Sequences Not Associated to Mycotoxin Biosynthesis***

Ochratoxin A was discovered as a secondary metabolite of *A. ochraceus* strains, which belongs to *Aspergillus* section *Circumdati*. Based on a polyphasic taxonomy,

which takes into account all accessible phenotypic and genotypic data and integrates them in a consensus classification, 20 species are distinguished into *Aspergillus* section *Circumdati*. The taxonomy of this section remains in progress, and Frisvad et al. (2004) recently proposed the division of *A. ochraceus* into two species, *A. ochraceus* and *A. westerdijkiae*. Several species in the section *Circumdati* are able to produce OTA in culture medium, but the main culprit species for the presence of OTA in food are *A. ochraceus* and *A. westerdijkiae* (Frisvad et al. 2004).

*A. westerdijkiae* and *A. ochraceus* are very similar, and several isolates previously identified as *A. ochraceus* are now recognized as *A. westerdijkiae*, including the original OTA-producing strain (NRRL 3174). Amplification and sequencing of the ITS1-5.8S-ITS2 region from several Brazilian strains of both species showed specific nucleotide variations that distinguish *A. westerdijkiae* and *A. ochraceus* (Fungaro et al. 2004b). In ITS1, all sequences of *A. westerdijkiae* differed from the *A. ochraceus* sequences by possessing a C instead of a T at positions 76 and 80. In addition, *A. ochraceus* has a deletion of a T at position 89. In ITS2, specific nucleotides at position 494–495 (AT) characterized the strains of *A. westerdijkiae*, compared to a TC at this position in *A. ochraceus*. Moreover, a T at position 487 is deleted only in *A. ochraceus* strains. Similarly, Morello et al. (2007) detected 39 species-specific single nucleotide polymorphisms within the  $\beta$ -tubulin genes from *A. westerdijkiae* and *A. ochraceus*, most of them (97.4%) in intronic regions. Eleven nucleotide substitutions and one heptanucleotide insertion/deletion were found in intron 3 (107 bp). Intron 4 (103 bp) was found to have six substitutions, one pentanucleotide insertion/deletion, and one dinucleotide insertion/deletion. Seven substitutions were found in intron 5 (87 bp).

The first report of a diagnostic PCR assay for *A. ochraceus* occurred in 2003 (Schmidt et al. 2003). The authors investigated the genetic relatedness among 70 strains with AFLP markers. A certain number of AFLP bands characteristic for *A. ochraceus* were detected. Three of these bands were cloned and sequenced, after which the sequences were used to design three primer pairs specific for *A. ochraceus*. The specificity of the primer pair OCA-V/OCA-R (Table 10.1) was tested with DNA of several different target strains as well as the closely related *Aspergillus* and *Penicillium* spp. and DNA isolated from noninfected green coffee. However, this primer pair is able to amplify DNA sequence from both *A. ochraceus* and *A. westerdijkiae* because it was developed previous to the division of formal *A. ochraceus* species into the two species mentioned above.

Patiño et al. (2005) developed a specific PCR assay (OCRA1/OCRA2; Table 10.1) for the detection of *A. ochraceus* on the basis of ITS sequence comparison between several strains of *Aspergillus* species. The specificity of the primer pair was tested on a number of *Aspergillus*, *Penicillium*, *Cladosporium*, *Botrytis*, and *Alternaria* strains commonly associated with grapes, cereals, and coffee. A single fragment of about 400 bp was only amplified from the genomic DNA of *A. ochraceus* strains. No product was amplified from genomic DNA from *Aspergillus* isolates other than *A. ochraceus* or from other genera. According to the authors, the sensitivity of the PCR assay based on ITS sequences was higher (1 and 10 pg of DNA template per reaction) than one based on a single copy gene (0.1 and

**Table 10.1** Primer sequences used for the detection of ochratoxin-A producing fungi

Species	Utility	Target region	Primer pair	Reference
<i>A. ochraceus</i>	Species-specific detection	AFLP marker	F5' ATACCACCGGTCTAATGCA R5' TGCCGACAGACCGAGTGGATT	Schmidt et al. (2003)
<i>A. ochraceus</i>	Species-specific detection	rRNA gene	F5' CTTCCTTAGGGTGGCACAGC R5' GTTGTCTTTCAGCGTCGGCC	Patiño et al. (2005)
<i>A. ochraceus</i>	Species-specific detection	<i>pkS</i> gene	F5' CATCTGGCGCAA'CGCTCTATCTTTC R5' CAATCACCCGAGGTCCAAGAGCCTCG	Dao et al. (2005)
<i>A. westerdijkiae</i>	Species-specific detection and quantification	$\beta$ -tubulin gene	F5' TGATACCTTGGCGCTTGTGACG R5' CGGAAGCTAAAAAATGAAGAG	Morello et al. (2007)
<i>A. niger</i>	Species-specific detection	RAPD marker	F5' CAGTCGTCCAGTACCCCTAAC R5' GAGCGAGGCTGATCTAAATG	Sartori et al. (2006)
<i>A. carbonarius</i>	Species-specific detection	rRNA gene	F5' GCATCTGCCCCCTCGG R5' GGTTGGAGTTGTGGCCAG	Patiño et al. (2005)
<i>A. carbonarius</i>	Species-specific detection	<i>pkS</i> gene	F5' TGGGTATGCCGGGTGAGGGTAT R5' CCGTAGGCTTCGAAAAACTGACAC	Dobson and O'Callaghan (2004)
<i>A. carbonarius</i>	Species-specific detection and quantification	<i>cmdA</i> gene	F5' CCGATG GAGGTCATGACATGA R5' AATGCGAACCCGGATATAACTTCTG	Mulè et al. (2006)
<i>A. carbonarius</i>	Species-specific detection	AFLP marker	F5' GAAITCACACACATCATAGC R5' TTA ACTAGGATTTGGCATTTGA AC	Schmidt et al. (2004a, b)
<i>A. carbonarius</i>	Species-specific detection and quantification	<i>pkS</i> gene	F5' AATATATCGACTATCTGGACGAGCG R5' CCCCTAGCGTCTCCCGAAG	Atoui et al. (2007)
<i>A. carbonarius</i>	Species-specific detection	RAPD marker	F5' AGGCTAATGTTGATAACGGATGAT R5' GCTGCAGTATGGACCTTAGAG	Fungaro et al. (2004a)
<i>A. carbonarius</i>	Species-specific detection	<i>pkS</i> gene	F5' CCCTGATCCTCGTATGATAGCG-3' R5' CCGGCCTTAGATTCTCTCAC-3'	Selma et al. (2008)
<i>A. carbonarius</i>	Species-specific detection	<i>cmdA</i> gene	F5' AAGCGAATCGATAGTCCACAAGAATAC R5' TCTGGCAGAAGTTAATATCCGGTT	Perrone et al. (2004)
<i>P. verrucosum</i>	Species-specific detection	<i>pkS</i> gene	F5' TGCACGACCGGGACAAATCA R5' CCGTAGGCCCTCCACAAAATCTG	Dobson and O'Callaghan (2004)
<i>P. nordicum</i>	Species-specific detection	<i>nrips</i> gene	F5' AGTCTTCGCTGGGTGCTCC R5' CAGCACTTTCCCTCCATCTATCC	Bogs et al. (2006)
<i>P. nordicum</i>	Species-specific detection	<i>pkS</i> gene	F5' TACGGCCATCTTGAGCAACGGCACTGCC R5' ATGCCTTCTGGGTCCGATA	Geisen et al. (2004)

1 ng of DNA template per reaction). The authors did not mention the new species *A. westerdijkiae*, and the primer pair presumably does not distinguish between *A. westerdijkiae* and *A. ochraceus*.

Morello et al. (2007) further exploited the genetic variation found between the  $\beta$ -tubulin gene sequences obtained from *A. ochraceus* and *A. westerdijkiae* with the aim of developing primers specific for *A. westerdijkiae*. The primer pair Bt2Aw-F/Bt2Aw-R was designed to specifically amplify *A. westerdijkiae* (Table 10.1). A 347-bp amplicon was visualized in all *A. westerdijkiae* isolates, but no PCR product was observed in *A. ochraceus* isolates. The Bt2Aw primers were successfully applied in detecting the 347-bp amplicon when using DNA collected from coffee beans inoculated with *A. westerdijkiae*.

The ochratoxigenic species *Aspergillus carbonarius* and *A. niger* belong to section *Nigri*, which is an important group of species in food mycology. As discussed in Samson et al. (2007), black aspergilli are one of the more complex groups in terms of classification and identification, and numerous taxonomic schemes have been proposed. The differences between some species belonging to section *Nigri* are very slight and their discrimination requires molecular analysis. A total of 16 species are recognized in *Aspergillus* section *Nigri*: *A. aculeatus*, *A. brasiliensis*, *A. carbonarius*, *A. costaricaensis*, *A. ellipticus*, *A. ellipsoides*, *A. japonicus*, *A. foetidus*, *A. homomorphus*, *A. heteromorphus*, *A. lacticoffeatus*, *A. niger*, *A. piperis*, *A. sclerotioniger*, *A. tubingensis*, and *A. vadensis*, with the latter taxon recently described as a new species (Samson et al. 2004; de Vries et al. 2005). *A. niger* sensu stricto, *A. tubingensis*, *A. foetidus* and *A. brasiliensis* are morphologically identical and collectively have been called the *A. niger* aggregate (Parenicová et al. 2001). Although the taxa included in the *A. niger* aggregate are morphologically indistinguishable, they differ in their ability to produce OTA and other metabolites. The ability of species other than *A. niger* sensu stricto within *A. niger* aggregate to produce OTA remain uncertain, probably due to the complexity of species identification.

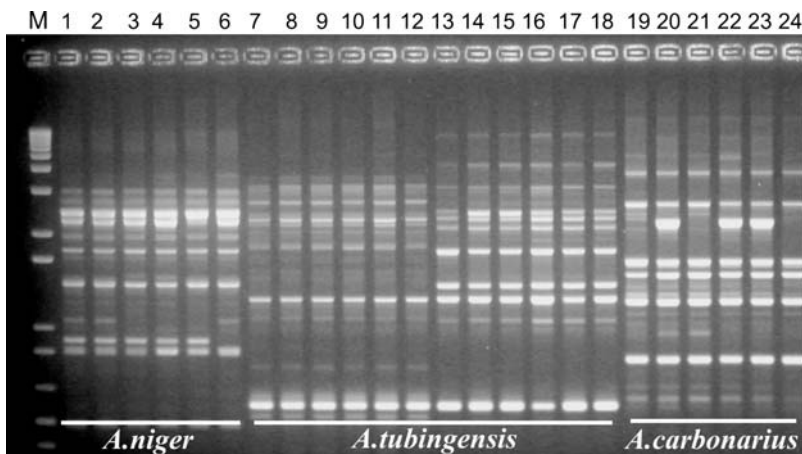
PCR-restriction fragment length polymorphism (RFLP) analysis of the ITS1-5.8S-ITS2 region allows the four *A. niger* aggregate taxa to be classified in two patterns (N and T). *A. foetidus* and *A. tubingensis* are classified as type T, and *A. niger* and *A. brasiliensis* are classified as type N by the Cabañes group (Accensi et al. 1999; Accensi et al. 2001). According to these authors, all OTA-producing strains were classified as pattern N, while none of the pattern T isolates produced OTA. Ueno et al. (1991) described an *A. foetidus* isolate that is able to produce OTA. However, according to Samson et al. (2004), no strains of *A. foetidus* sensu stricto produce OTA. Consistent with this analysis, the strain CBS 618.78 of *A. foetidus* that was described as an OTA producer was later shown to be *A. niger* and not *A. foetidus* (Samson et al. 2004).

Although it was assumed for several years that *A. tubingensis* was not able to produce OTA (Samson et al. 2004), two research groups recently found OTA-producing isolates of this species (Medina et al. 2005; Perrone et al. 2006). We have analyzed several isolates within the *A. niger* aggregate (obtained from Brazilian coffee beans and dried fruit from worldwide origin) in our own laboratory and

found that only *A. niger* sensu stricto was an OTA producer; i.e., none of the *A. tubingensis* or *A. foetidus* isolates analyzed was able to produce OTA (unpublished data). This situation demonstrates the importance of the development of specific markers for the identification and detection of a particular ochratoxigenic fungal species.

A specific PCR assay for the detection of *A. carbonarius* was developed by Patiño et al. (2005) based on ITS sequences. The primer pair CAR1/CAR2 generated an amplicon of 420 bp exclusively from *A. carbonarius* genomic DNA (Table 10.1). Schmidt et al. (2004b) used AFLP to detect specific markers for *A. carbonarius*. A certain number of amplified fragments were found to be specific to this species. The marker fragments were cloned, sequenced, and used to design a specific primer pair to detect this species. The primer pairs A1B-fw/A1B-rv and C1B-fw/C1B-rv amplify 189 bp and 351 bp fragments, respectively, in all *A. carbonarius* isolates tested (Table 10.1). Based on an alignment of calmodulin (*cmdA*) gene sequences, Perrone et al. (2004) identified regions suitable to design specific PCR primers for the detection of *A. carbonarius*. The primer pair CARBO1/2 produced a PCR product of 371 bp with a sensitivity of about 12 pg when using pure total genomic DNA. Although the PCR assay was useful in screening isolates of black aspergilli from grapes, the authors did not use it to detect *A. carbonarius* strains directly from sample materials.

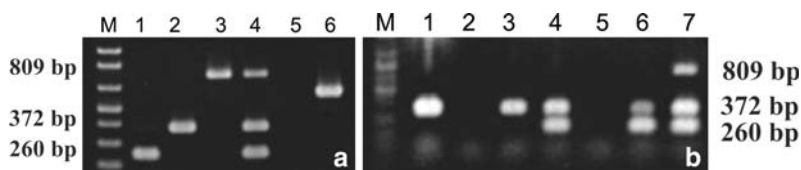
Several strains representing closely related black aspergilli, i.e., *A. carbonarius*, *A. niger*, and *A. tubingensis*, were analyzed by RAPD with the aim of developing species-specific primers for the detection of *A. carbonarius* in coffee beans (Fungaro et al. 2004a). A typical RAPD pattern is shown in Fig. 10.2. Some



**Fig. 10.2** Amplification of polymorphic DNA from *A. niger* (lanes 1–6), *A. tubingensis* (lanes 7–18), and *A. carbonarius* (lanes 19–24) strains with the OPX7 random primer. The molecular weight standard (M) is a 1-kb DNA ladder

DNA bands were present in all *A. carbonarius* strains and absent in all strains of *A. niger* and *A. tubingensis*. One of these bands was cloned and sequenced, and then used to design a primer pair specific to *A. carbonarius* (OPX7<sub>809</sub>-F/OPX7<sub>809</sub>-R) (Table 10.1). Using this primer-pair, the authors successfully detected an amplicon of 809 bp when DNA from coffee beans infected with *A. carbonarius* strains was used. No cross-reaction was observed with DNA from coffee beans infected with closely related black aspergilli. Similarly, based on RAPD markers, Sartori et al. (2006) developed specific primers to detect *A. niger* (Table 10.1). The primer pair denoted OPX7<sub>372F</sub>/ OPX7<sub>372R</sub> generated an amplicon of 372 bp in all *A. niger* stricto sensu isolates, and no amplification product was observed in reactions using DNA from related species. This PCR assay was successfully applied in detecting *A. niger* in coffee beans.

Brazil is the largest coffee bean producer and exporter in the world. Studies concerning fungi with the potential for colonizing Brazilian coffee beans and producing OTA showed that *A. ochraceus* (now *A. westerdijkiae*), *A. carbonarius*, and *A. niger* are the major species in Brazilian coffee beans. Based on this observation, our group developed a multiplex PCR assay that can detect these three target fungi species directly from coffee bean samples (Sartori et al. 2006). Multiplex PCR (m-PCR) is a procedure that allows the simultaneous amplification of more than one target sequence in a single PCR reaction, decreasing the number of reactions that must be performed to assess the possible presence of different species in a food sample. Sartori et al. (2006) first analyzed the value of the m-PCR assay with DNA obtained from coffee beans inoculated with these three species. Figure 10.3a shows the amplification profiles from simultaneous use of the primer pairs designed for *A. westerdijkiae*, *A. carbonarius*, and *A. niger*. Amplification products of 260, 809, and 372 bp in a single PCR reaction confirmed the presence of



**Fig. 10.3** (a) Amplification products obtained from DNA isolated from inoculated coffee beans. Lane 1: DNA from coffee beans inoculated with *A. ochraceus* amplified with OCA V and OCA R primers; lane 2: DNA from coffee beans inoculated with *A. niger* amplified with OPX7F<sub>372</sub> and OPX7R<sub>372</sub> primers; lane 3: DNA from coffee beans inoculated with *A. carbonarius* amplified with OPX7F<sub>809</sub> and OPX7R<sub>809</sub> primers; lane 4: multiplex PCR using DNA from coffee beans inoculated with *A. ochraceus*, *A. niger*, and *A. carbonarius* amplified with all three sets of primer pairs; lane 5: negative control (DNA from coffee beans without fungal inoculation); lane 6: positive PCR control (*A. niger* DNA amplified with the primers ITS1 and ITS4). (b) Multiplex PCR obtained from naturally contaminated coffee beans. Lane 1: detection of *A. niger*; lane 2: no fungi detected; lane 3: detection of *A. niger*; lane 4: detection of *A. niger* and *A. ochraceus*; lane 5: no fungi detected; lane 6: detection of *A. niger* and *A. ochraceus*; lane 7: positive control of the multiplex assay (DNA from coffee beans inoculated with *A. carbonarius*, *A. niger* and *A. ochraceus*). Reproduced from Sartori et al. (2006) with permission)



*A. westerdijkiae*, *A. carbonarius*, and *A. niger*, respectively. The usefulness of the multiplex PCR assay was also analyzed in coffee bean samples collected on farms. As shown in Fig. 10.3b, this methodology successfully allowed the detection of amplification products from naturally occurring fungi in coffee beans.

*Penicillium verrucosum* has been commonly isolated from cereal crops and is the principal OTA-producing fungus in cool, damp climatic regions (Pitt and Hocking 1997). This species is morphologically very similar to the related species *P. nordicum*, which is mainly isolated from proteinaceous foods like cheese and fermented meat (Larsen et al. 2001; Castellá et al. 2002). *P. nordicum* is a high OTA producer in vitro, but until now the ability of this species to produce OTA in its natural environment has not been tested (Bogs et al. 2006).

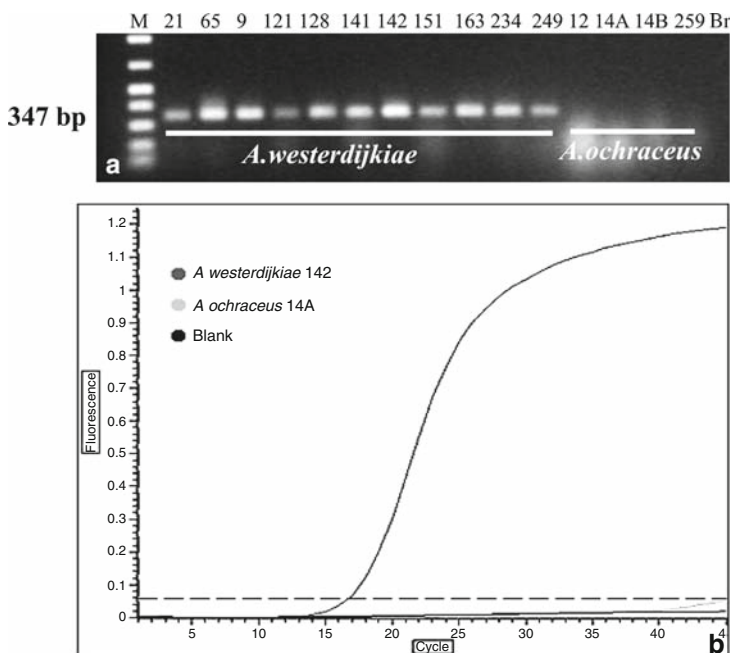
Castellá et al. (2002) used RAPD, AFLP, and ITS sequencing to characterize two groups of *Penicillium* OTA-producing strains that differed in their ability to produce OTA, with group I containing mainly high-producing strains, and group II containing moderate to nonproducing strains. The strains from group I originate from foods, such as cheese and meat products, while the strains from group II originate from plants. The ribosomal ITS1-5.8S-ITS2 sequences were similar, except for two single nucleotide exchanges in several strains of each group. Group I was recognized as *P. nordicum* and Group II as *P. verrucosum*. The authors did not attempt to design species-specific primers to detect either species of *Penicillium*.

Although conventional PCR is a valuable tool for detecting and monitoring mycotoxigenic fungi, it is not appropriate to quantify a given fungus species in a food sample. Small differences in reaction efficiency per cycle can result in a substantial difference in the final product quantity, and so it is very difficult to extrapolate the initial concentration of the template in the sample from the final product (Hill 1996). Fortunately, the introduction of the real-time PCR technology has increased the reliability of PCR results compared to those obtained by conventional methods, thus opening new avenues for quantifying ochratoxigenic fungi in food. Real-time PCR is more sensitive than classical PCR and does not require gel electrophoresis. The analysis can be concluded in less than 5 h. These attributes of real-time PCR significantly reduce time and manual labor, making it appropriate for large-scale analyses.

The use of fluorophores is common to most of these methods and is described in detail by Boysen et al. (2000). By using real-time PCR it is possible to detect an increase in fluorescence emission during the reaction which is proportional to the initial copy number of the target sequence. The initial amount of template DNA is inversely proportional to a parameter measured for each reaction, which is denoted as the threshold cycle ( $C_t$ ). The  $C_t$  value is the PCR cycle when the fluorescence signal increases above the background threshold. The application of this method to natural samples can provide an estimate of infection by a given species.

Because *A. westerdijkiae* consistently produces large amounts of OTA, Morello et al. (2007) evaluated the potential of the real-time PCR approach for quantification of this species in coffee beans (Fig. 10.4). A real-time PCR standard curve was obtained with a range of initial amounts of *A. westerdijkiae* total DNA (20; 10; 5; 1; 0.5 and 0.1 ng per reaction) showing a good correlation ( $r^2 = 0.982$ ). Green

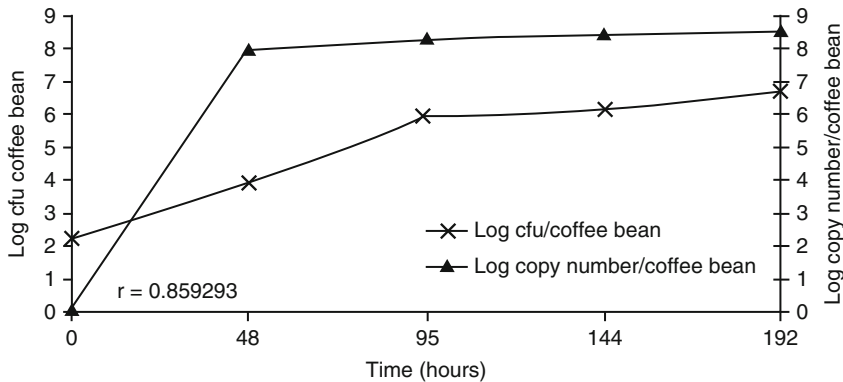




**Fig. 10.4** Discrimination between *A. westerdijkiae* and *A. ochraceus* by (a) conventional PCR and (b) real-time PCR. Reproduced from Morello et al. (2007) with permission

coffee beans were inoculated with  $10^6$  *A. westerdijkiae* conidia and incubated for 192 h at 28°C. DNA extraction and a colony forming unit (cfu) assay were performed every 48 h. A high correlation was observed between the cfu data and the fungal DNA content in the coffee beans (Fig. 10.5). The authors also assessed the sensitivity of this method in order to detect *A. westerdijkiae* in coffee beans. Serial dilutions ( $10^{-1}$ – $10^{-9}$ ) of DNA extracted from infected coffee beans after 48 h of incubation generated a positive signal at up to  $10^{-5}$  dilution, showing that less than 10 and more than 1 single copy of the *A. westerdijkiae* haploid genome can be detected by this methodology. This value also indicated that less than 10 haploid genomes could be detected per 0.1 g of coffee beans. Thus, the real-time PCR assay was more than 100 times more sensitive than the cfu technique.

A quantitative real-time PCR assay was developed to detect and quantify *A. carbonarius* in grapes as a possible tool for predicting potential ochratoxigenic risk (Mulè et al. 2006). The species-specific primers and probes used by the authors were derived from conserved regions of the *A. carbonarius* calmodulin gene. The quantification of fungal genomic DNA in naturally contaminated grapes was performed using the TaqMan signal versus spectrophotometrically measured DNA quantities ( $\log_{10}$ ) calibration curve with a linearity range from 50 to  $5 \times 10^{-4}$  ng of DNA. A positive correlation ( $r^2 = 0.92$ ) was found between *A. carbonarius* DNA content and OTA concentration in naturally contaminated grape samples.



**Fig. 10.5** Comparison of cfu data and the haploid genome copy number of *A. westerdijkiae* in inoculated coffee beans. Reproduced from Morello et al. (2007) with permission

The sensitivity of the PCR method is crucial in the detection of foodborne microorganisms. Unfortunately, there is no standard for reporting sensitivity. Some authors refer to sensitivity as the minimum picograms of DNA that can be detected (Bluhm et al. 2002; Schmidt et al. 2004a; Patiño et al. 2005), others refer to it as the minimum percentage of infected grains in a sample (Schmidt et al. 2004a), and more recently, the lowest detectable number of haploid genomes was also used (Mulè et al. 2006). To eliminate confusion and uncertainties regarding sensitivity, a single method for sensitivity calculation should be adopted. We suggest that the number of haploid genomes per gram of sample is the most convenient metric with which to indicate PCR sensitivity.

### 10.1.3 PCR-Based Detection and Quantification of Ochratoxigenic Species with Biosynthetic Pathway Genes

Various enzymes can be expected to catalyze key reactions in the formation of OTA based on its structure. Some teams of researchers are currently looking for genes related to OTA biosynthesis (Lebrihi et al. 2003; Geisen et al. 2004; Atoui et al. 2006; O'Callaghan et al. 2006; Bogs et al. 2006). A polyketide synthase is predicted to be involved in OTA biosynthesis because the isocoumarin group of OTA is a pentaketide likely to be formed from acetate and malonate via a polyketide synthesis pathway (O'Callaghan et al. 2003).

The diversity of polyketide synthase genes has been investigated in *A. carbonarius* (Atoui et al. 2006). Two nonconserved sequences in the acyltransferase domain of a polyketide synthase gene, denoted *Ac12RL3*, were used as a target sequence to specifically detect *A. carbonarius* by PCR. The primer pair *Ac12RL\_OTAF/*

Ac12RL\_OTAR (Table 10.1) generated a 141-bp PCR product in all *A. carbonarius* isolates studied, while no other species gave a positive result with this PCR primer set (Atoui et al. 2007). This specific primer pair was successfully employed to directly quantify *A. carbonarius* in grape samples.

With the same objective, i.e., to quantify *A. carbonarius* in grape samples, Atoui et al. (2006) used a specific primer pair (Ac12RL\_OTAF/Ac12RL\_OTAR) (Table 10.1) that was designed from the acyltransferase (AT) domain of the polyketide synthase sequence (Ac12RL3) to amplify a 141-bp PCR product. Using real-time PCR conjugated with SYBR Green I dye, the authors found a positive correlation ( $r^2 = 0.81$ ) between *A. carbonarius* DNA content and OTA concentration in 72 grape samples.

A real-time PCR system based on the *otapks*PN sequence was used to monitor the growth and OTA production of *P. nordicum* in wheat (Geisen et al. 2004). A strong correlation between the copy numbers of the *otapks*PN gene and cfu was observed.

Several analytical methods for the detection of OTA are available, and the level of this mycotoxin can readily be measured very accurately in food. However, this kind of analysis only returns a positive result once the toxins have been formed. Similarly, several methods for the detection of ochratoxigenic species have been described, but the presence of an ochratoxigenic fungus in a food sample does not ultimately indicate the production of OTA. The formation of OTA depends strongly on environmental conditions such as substrate, water activity, pH, and temperature. Based on these points, the measurement of mycotoxin gene expression would allow more meaningful monitoring of OTA in food; these genes are frequently expressed some days prior to the mycotoxin production and thus would allow an early warning (Schmidt-Heydt and Geisen 2007). According to some authors, the expression analysis of key mycotoxin biosynthetic genes might be useful as Hazard Analysis and Critical Control Point (HACCP) for the food industry (Geisen et al. 2004; Niessen 2007).

The first relevant report of the cloning and characterization of putative polyketide synthase gene (*pks*) from OTA-producing *Aspergillus* was provided by O'Callaghan et al. (2003). These authors used a molecular strategy denoted "Suppression Subtractive Hybridization PCR-Based." The predicted amino acid sequence of a 1.4-kb clone shared 28–35% identity with acyltransferase regions from fungal polyketide synthases found in the databases. Based on reverse transcription PCR studies, the authors showed that this *pks* gene is expressed only under OTA-permissive conditions and only during the early stages of mycotoxin synthesis. A mutant in which the *pks* gene has been interrupted was not able to synthesize OTA. The authors later examined OTA production by *A. ochraceus* grown under different nutritional and environmental conditions. Quantifications of *pks* transcript accumulation showed that *pks* transcription is tightly linked to OTA production (O'Callaghan et al. 2006). As reviewed by Niessen (2007), the University College Cork (Ireland) filed world wide (WO 2004/072224) as well as European (EP 1592705A2) patent applications based on Irish priority application (IE 20030095) based on O'Callaghan's results. The patent claims cover the use of the sequence for the purpose of detecting OTA producers as well as its use for primer walking.

Geisen et al. (2004) used degenerate primers to detect and characterize a portion of a polyketide synthase gene from *Penicillium nordicum*. All analyzed *P. nordicum* strains possessed the fragment, whereas the closely related ochratoxigenic *P. verrucosum* strains did not. An expression analysis of this gene demonstrated that it is highly induced under OTA-producing conditions but only at low levels under nonproducing conditions. In addition, a strong congruence between *otapksPN* gene expression and OTA production in wheat was observed.

Microarray technology is suitable to analyze gene expression on a global level and may be useful for detecting mycotoxigenic fungi before mycotoxins are produced. For this purpose, the mRNA from a given sample is used to generate a labeled sample, termed the “target,” which is hybridized with a large number of DNA sequences that are immobilized on a solid surface in an ordered array. Schmidt-Heydt and Geisen (2007) developed a microarray (DNA chip) that contains oligonucleotides homologous to genes from several fungal species that are responsible for the biosynthesis of mycotoxins. Consequently, this microarray covers most of the known relevant mycotoxin biosynthesis genes.

However, it is important to state that although this gene is really more expressed by a positive strain under OTA-permissive conditions, no information is available about the expression of this gene by OTA-nonproducing strains. A preliminary investigation carried out by our group showed that the *pks* gene, described by O’Callaghan et al. (2003), is in fact significantly more expressed by *A. westerdijkiae* when grown in OTA-permissive conditions than when grown in OTA-restrictive conditions. However, when we cultivated two negative strains in permissive conditions, the *pks* gene was expressed at levels similar to those of a positive strain, even though they did not produce OTA (unpublished data). This probably occurs because other secondary metabolites require the function of the *pks* gene. This observation stresses the importance of identifying genes that are differentially expressed between OTA-producing strains and OTA-nonproducing strains.

## 10.2 Conclusions

Over the last 5 years, several molecular assays for the identification and fast detection of ochratoxigenic species without the need for isolating pure cultures have been published. These assays include conventional PCR, real-time PCR, RT real-time PCR, and microarray technology. Until now, they have been used in research laboratories to detect putative mycotoxin-producing fungi in culture or even in food samples to obtain information on the epidemiology and ecology of ochratoxigenic species or to acquire basic information on gene expression. The use of molecular assays in routine analyses in the food and feed industries remains a challenge. Specificity, sensitivity and simplicity of analysis are all areas that must be improved before these molecular assays become useful for practical applications. Furthermore, OTA biosynthesis is poorly understood relative to the synthesis pathways of other economically important mycotoxins. Better knowledge of the

genes involved in OTA biosynthesis is necessary to effectively predict the risk of OTA production. Even so, we are optimistic that molecular technologies will be useful for large-scale analyses in the near future, and will be regularly used as a preventive approach to minimize ochratoxin entry into the food chain.

## References

- Accensi F, Caño J, Figueira L, Abarca ML, Cabañes FJ (1999) New PCR method to differentiate species in the *Aspergillus niger* aggregate. FEMS Microbiol Lett 180:191–196
- Accensi F, Abarca ML, Caño J, Figueira L, Cabañes FJ (2001) Distribution of ochratoxin A producing strains in the *A. niger* aggregate. Antonie Van Leeuwenhoek 79:365–370
- Atoui A, Dao P, Mathieu F, Lebrihi A (2006) Amplification and diversity analysis of ketosynthase domains of putative polyketide synthase genes in *Aspergillus ochraceus* and *Aspergillus carbonarius* producers of ochratoxin A. Mol Nutr Food Res 50:448–493
- Atoui A, Mathieu F, Lebrihi A (2007) Targeting a polyketide synthase gene for *Aspergillus carbonarius* quantification and ochratoxin A assessment in grapes using real-time PCR. Int J Food Microbiol 115:313–318
- Battilani P, Pietri A (2002) Ochratoxin A in grapes and wine. Eur J Plant Pathol 108:639–643
- Battilani P, Pietri A, Bertuzzi T, Languisio L, Giorni P, Kozakiewicz Z (2003) Occurrence of ochratoxin A – producing fungi in grapes grown in Italy. J Food Prot 66:633–636
- Bayman P, Baker JL, Doster MA, Michailides TJ, Mahoney NE (2002) Ochratoxin production by the species *Aspergillus ochraceus* group and *Aspergillus alliaceus*. Appl Environ Microbiol 68:2326–2329
- Bennett JW, Ciegler A (1983) Secondary metabolism and differentiation in fungi. Marcel Dekker, New York
- Bennett JW, Klich M (2003) Mycotoxins. Clin Microbiol Rev 16:497–516
- Bluhm BH, Flaherty JE, Cousin MA, Woloshuk CP (2002) Multiplex polymerase chain reaction assay for the differential detection of trichothecene and fumonisin producing species of *Fusarium* in corn meal. J Food Prot 65:1955–1961
- Bogs C, Battilani P, Geisen R (2006) Development of a molecular detection and differentiation system for ochratoxin A producing *Penicillium* species and its application to analyse the occurrence of *Penicillium nordicum* in cured meats. Int J Food Microbiol 107:39–47
- Boysen ME, Jacobson J, Schnurer J (2000) Molecular identification of species from the *Penicillium roqueforti* group associated with spoiled. Appl Environ Microbiol 66:1523–1526
- Bucheli P, Taniwaki MH (2002) Research on the origin and the impact of post-harvest handling and manufacturing on the presence of ochratoxin A in coffee. Food Addit Contam 19:655–665
- Carter PN, Vetrie D (2004) Applications of genomic microarrays to explore human chromosome structure and function. Hum Mol Genet 13:297–302
- Castellá G, Larsen TO, Cabañes FJ, Schmidt H, Alboresi A, Niessen L, Färber P, Geisen R (2002) Molecular characterization of ochratoxin A producing strains of the genus *Penicillium*. Syst Appl Microbiol 25:74–83
- Dao HP, Mathieu F, Lebrihi A (2005) Two primer pairs to detect OTA producers by PCR method. Int J Food Microbiol 104:61–67
- Dobson A, O’Callaghan J (2004) Detection of ochratoxin A producing fungi. Patent no. WO 2004/072224 A2
- Frisvad JC, Frank JM, Houbraken J, Kujipers AFA (2004) New ochratoxin A producing species of *Aspergillus* section *Circumdati*. Stud Mycol 50:23–43
- Fungaro MHP, Vissotto PC, Sartori D, Vilas-Boas LA, Furlaneto MC, Taniwaki MH (2004a) A molecular method for detection of *Aspergillus carbonarius* in coffee beans. Curr Microbiol 49:123–127

- Fungaro MHP, Magnani M, Vilas-Boas LA, Vissotto PC, Furlaneto MC, Vieira MLC, Taniwaki MH (2004b) Genetic relationships among Brazilian strains of *Aspergillus ochraceus* based on RAPD and ITS sequences. *Can J Microbiol* 50:985–988
- Geisen R (1998) PCR methods for the detection of mycotoxin producing fungi. In: Bridge PD, Arora KK, Reddy CA, Elander RP (eds) *Applications of PCR in micology*. CAB International, Cambridge, UK, pp 243–266
- Geisen R, Mayer Z, Karolewicz A, Färber P (2004) Development of a real time PCR system for detection of *Penicillium nordicum* and for monitoring ochratoxin A production in foods by targeting the ochratoxin polyketide synthase gene. *Syst Appl Microbiol* 27:501–507
- Hill WE (1996) The polymerase chain reaction: applications for the detection of foodborne pathogens. *Crit Rev Food Sci Nutr* 36:123–173
- IARC (International Agency for Research on Cancer) (1993) Ochratoxin A. Monographs on the evaluation of carcinogenic risks to humans: some naturally occurring substances, food items and constituents, heterocyclic aromatic amines and mycotoxines. IARC Monographs on the Evaluation of Carcinogenic Risks to Humans 56:489–521
- Jorgensen K (1998) Survey pork, poultry, coffee, beer and pulses for ochratoxin A. *Food Addit Contam* 15:550–555
- Jorgensen K, Jacobsen JS (2002) Occurrence of ochratoxin A in Danish wheat and rye, 1992–1999. *Food Addit Contam* 19:1184–1189
- Khalidi N, Collemare J, Lebrun M, Wolfe KH (2008) Evidence for horizontal transfer of a secondary metabolite gene cluster between fungi. *Gen Biol* 9:R18.1–R18.10
- Larsen TO, Svendsen A, Smedsgaard J (2001) Biochemical characterization of ochratoxin A-producing strains of the genus *Penicillium*. *Appl Environ Microbiol* 67:3630–3635
- Lebrihi A, Mathieu F, Borgida LP, Guyonvarch AM (2003) Method for the detection of ochratoxin A or citrinin-producing fungi. European patent No. EP1329521
- Lund F, Frisvad JC (2003) *Penicillium verrucosum* in wheat and barley indicates presence of ochratoxin A. *J Appl Microbiol* 95:1117–1123
- Maaroufi K, Achour A, Betbeder AM, Hammami M, Ellouz F, Creppy EE, Bacha H (1995) Foodstuffs and human blood contamination by the mycotoxin ochratoxin A: correlation with chronic interstitial nephropathy in Tunisia. *Archiv Toxicol* 69:552–558
- Mantle PG, McHugh KM (1993) Nephrotoxic fungi in foods from nephropathy households in Bulgaria. *Mycol Res* 97:205–212
- Medina A, Mateo R, López-Ocaña L, Valle-Algarra FM, Jimenez M (2005) Study of Spanish grape mycobiota and ochratoxin A production by isolates of *Aspergillus tubingensis* and other members of *Aspergillus* section *Nigri*. *Appl Environ Microbiol* 71(8):4696–4702
- Morello LG, Sartori D, Martinez ALO, Vieira MLC, Taniwaki MH, Fungaro MHP (2007) Detection and quantification of *Aspergillus westerdijkiae* in coffee beans based on selective amplification of  $\beta$ -tubulin gene by using real-time PCR. *Int J Food Microbiol* 119:270–276
- Mulè G, Susca A, Logrieco A, Stea G, Visconti A (2006) Development of a quantitative real-time PCR assay for the detection of *Aspergillus carbonarius* in grapes. *Int J Food Microbiol* 111 (Suppl 1):S28–S34
- Mullis KB, Faloona FA (1987) Specific synthesis of DNA *in vitro* via a polymerase-catalyzed chain reaction. *Methods Enzymol* 155:335–335
- Niessen L (2007) PCR-based diagnosis and quantification of mycotoxin producing fungi. *Int J Food Microbiol* 119:38–46
- O’Callaghan J, Caddick MX, Dobson AD (2003) A polyketide synthase gene required for ochratoxin A biosynthesis in *Aspergillus ochraceus*. *Microbiology* 149:3485–3491
- O’Callaghan J, Stapleton PC, Dobson AD (2006) Ochratoxin A biosynthetic genes in *Aspergillus ochraceus* are differentially regulated by pH and nutritional stimuli. *Fungal Genet Biol* 43:213–221
- Parenticová L, Skouboe P, Frisvad J, Samson R, Rossen L, Hoor-Suykerbyuk MT, Visser J (2001) Combined molecular and biochemical approach identifies *Aspergillus japonicus* and *Aspergillus aculeatus* as two species. *Appl Environ Microbiol* 67:521–527

- Patiño B, González-Salgado A, González-Jaén MT, Vázquez C (2005) PCR detection assays for the ochratoxin producing *Aspergillus carbonarius* and *Aspergillus ochraceus* species. *Int J Food Microbiol* 104:207–214
- Perrone G, Susca A, Stea G, Mulè G (2004) PCR assay for identification of *Aspergillus carbonarius* and *Aspergillus japonicus*. *Eur J Plant Pathol* 110:641–649
- Perrone G, Mulè G, Susca A, Battilani P, Pietri A, Logrieco A (2006) Ochratoxin A production and amplified fragment length polymorphism analysis of *Aspergillus carbonarius*, *Aspergillus tubingensis* and *Aspergillus niger* strains isolated from grapes in Italy. *Appl Environ Microbiol* 72:680–685
- Petzinger E, Weidenbach A (2002) Mycotoxins in the food chain: the role of ochratoxins. *Liv Produc Sci* 76:245–250
- Pitt JL, Hocking AD (1997) *Fungi and food spoilage*. Blackie Academic and Professional, London
- Russell R, Paterson M (2006) Identification and quantification of mycotoxigenic fungi by PCR. *Proc Biochem* 41:1467–1474
- Saiki R, Scharf S, Faloona F, Mullis K, Horn GT, Ehrlich HA, Arnheim M (1985) Enzymatic amplification of  $\beta$ -globin genomic sequences and restriction site analysis for diagnosis of sickle cell anemia. *Science* 239:487–491
- Samson RA, Houbraken JAMP, Kujipers AFA, Frank JM, Frisvad JC (2004) New ochratoxin A or sclerotium producing species in *Aspergillus* section *Nigri*. *Stud Mycol* 50:45–61
- Samson RA, Noomin P, Meijer M, Houbraken J, Frisvad JC, Varga J (2007) Diagnostic tools to identify black *Aspergilli*. *Stud Mycol* 59:129–145
- Sartori D, Furlaneto MC, Martins MK, Paula MRF, Pizzirani-Kleiner A, Taniwaki MH, Fungaro MHP (2006) PCR method for the detection of potential ochratoxin-producing *Aspergillus* species in coffee beans. *Res Microbiol* 157:350–354
- Schmidt H, Ehrmann M, Vogel RF, Taniwaki MH, Niessen L (2003) Molecular Typing of *Aspergillus ochraceus* and construction of species specific SCAR-primers based on AFLP. *Syst Appl Microbiol* 26:138–146
- Schmidt H, Bannier M, Vogel RF, Niessen L (2004a) Detection and quantification of *Aspergillus ochraceus* in green coffee by PCR. *Lett Appl Microbiol* 38:464–469
- Schmidt H, Taniwaki MH, Vogel RF, Niessen L (2004b) Utilization of AFLP markers for PCR-based identification of *Aspergillus carbonarius* and indication of its presence in green coffee samples. *J Appl Microbiol* 97:899–909
- Schmidt-Heydt M, Geisen R (2007) A microarray for monitoring the production of mycotoxins in foods. *Int J Food Microbiol* 117:131–140
- Selma MV, Martínez-Culebras PV, Aznar R (2008) Real-time PCR based procedures for detection and quantification of *Aspergillus carbonarius* in wine grapes. *Int J Food Microbiol* 122:126–134
- Smith JE, Henderson RS (1991) *Mycotoxins and animal foods*. CRC Press, London, pp 816–841
- Taniwaki MH, Pitt JI, Teixeira AA, Iamanaka BT (2003) The source of ochratoxin A in Brazilian coffee and its formation in relation to processing methods. *Int J Food Microbiol* 82:173–179
- Ueno Y, Kawakura O, Sugiura Y, Horiguchi K, Nakajima M, Yamamoto K, Sato S (1991) Use of monoclonal antibodies enzyme-linked immunosorbent assay and immunoaffinity column chromatography to determine ochratoxin A in porcine sera coffee products and toxin-producing fungi. In: Castegnaro M, Plestina R, Dirheimer G, Chernozemsky IN, Bartsch H (eds) *Mycotoxins, Endemic Nephropathy and Urinary Tract Tumours*, IARC – Sci – Publ. Lyon, France, pp 71–75
- Van der Merwe KJ, Steyn PS, Fourie L, Scott DB, Theron JJ (1965) Ochratoxin A, a toxic metabolite produced by *Aspergillus ochraceus* Wilh. *Nature* 205:1112–1113
- Varga J, Kozakiewicz Z (2006) Ochratoxin A in grapes and grape-derived products. *Trends Food Sci Technol* 17:72–81
- Visconti A, Pascale M, Cewntonze G (2001) Determination of ochratoxin A in wine and beer by immunoaffinity column cleanup and liquid chromatographic analysis with fluorometric detection: collaborative study. *J AOAC Intern* 8:1818–1827

- Vos P, Hogers R, Bleeker M, Reijans M, Van de Lee T, Hornes M, Frijters A, Pot J, Peleman J, Kuiper M, Zabeau M (1995) AFLP: a new technique for DNA fingerprinting. *Nucl Acids Res* 23:4407–4414
- de Vries RP, Frisvad JC, van de Vondervoort PJI, Burgers K, Kujipers AFA, Samson RA, Visser J (2005) *Aspergillus vadensis*, a new species of the group of black aspergilli. *Antonie Van Leeuwenhoek* 87:195–203
- Wafa EW, Yahya RS, Sobh MA, Eraky I, el-Baz M, el-Gayar HA, Betbeder AM, Creppy EE (1998) Human ochratoxycosis and nephropathy in Egypt: a preliminary study. *Hum Experim Toxicol* 17:124–129
- Williams JGK, Kubelik AR, Livak KJ, Rafalski JA, Tingey SV (1990) DNA polymorphisms amplified by arbitrary primers are useful as genetic markers. *Nucleic Acids Res* 18:6531–6536
- Wolff J, Bresch H, Cholmakov-Bodechtel C, Engel G, Garais M, Majerus P, Rosner H, Scheur R (2000) Ochratoxin A: contamination of foods and consumer exposure. *Archiv Lebensmitt* 51:81–128



# Chapter 11

## Molecular Barcoding of Microscopic Fungi with Emphasis on the Mucoralean Genera *Mucor* and *Rhizopus*

Youssuf Gherbawy, Claudia Kesselboth, Hesham Elhariry,  
and Kerstin Hoffmann

**Abstract** A broad range of fungi were isolated from different geographic regions and substrates and identified according to traditional and modern methods. A total of 120 different isolates were assigned to the phyla, Basidiomycota with 8 isolates, Ascomycota with 75 isolates, and “Zygomycota” with 37 isolates. Although morphological characters were able to differentiate the isolates to their phyla and in most cases to the correct genera, a combination of several methods is always recommended because characterization and identification of unknown fungal isolates is highly error-prone if relying on single methods. Sequence-based identification turned out to be reliable for most Ascomycetes and Zygomycetes. But with the ongoing questionable trend to rely on sequences as first source information for species separation, the most serious problems are the annotation problems in public reference databases, the inconsistency of described taxa, and the available reference data.

### 11.1 Introduction and Background

The characterization and identification of organisms is fundamental in biological life sciences. Each individual in general is regarded to be composed of numerous, if not countless, characters. Every definable character could be used for descriptive and comparative studies concerning all applied aspects of life. Such characters could be features of morphology, biochemical composition, physiological characters,

---

Y. Gherbawy and C. Kesselboth

Botany Department, Faculty of Science, South Valley University, 83523 Qena, Egypt

K. Hoffmann

Institute of Microbiology, School of Biology and Pharmacy, University of Jena, Neugasse 25,  
07743 Jena, Germany

e-mail: Hoffmann.Kerstin@uni-jena.de

H. Elhariry

Biological Sciences Department, Faculty of Science, Taif University, P.O. Box 888 Taif, Kingdom  
of Saudi Arabia

ecological properties, metabolic characteristics, or molecular features ranging from mere nucleotide and amino acid sequences to structures, functions, and regulation.

Molecular data have several advantages over other characters because they are not subjected to the highly subjective eye of an investigator if morphological criteria are investigated. Also, they are independent from environmental or nutritional conditions influencing metabolism, cell composition, or cellular appearance. Moreover, molecular data by means of nucleic acid sequences are quite easy to access compared to chemotaxonomical criteria, which require cost-intensive laboratory equipment, as for performance of gas chromatography–mass spectrometry. A major drawback is that chemotaxonomical markers are prone to external influences and physiological variability and therefore hard to reproduce. But a solely single nucleotide sequence of a certain gene marker is not capable to designate an organism to a species or reveal the actual features displayed by that organism. In the end, a pure sequence is useless information without further data on the organism of its origin, the locality of its isolation, and its preferred substrate. In this respect, the identification of an organism must not depend on single methods; it should rather be supported by a bunch of different criteria. Comparing and analysing all available data gives insight into the biodiversity of the Earth and allows the reconstruction of the evolutionary history of the organism. Well-supported taxonomic relationships are necessary for the precise and reliable classification of new and unknown specimens. Consequently, the reconstruction of phylogenetic relationships works for well-studied species only, if based solely on molecular information without knowledge of morphological, physiological, or ecological features. The exploration of new specimens clearly depends on more than one criterion. Taxonomic systems based on reconstructed phylogenetic relationships are essential for a sustainable organisation of biological information and a deeper understanding of the evolution and species diversification (Fenchel and Finlay 2006; Wheeler 2004). Identification and classification of unknown specimens requires a broad sample of well-defined and described reference specimens for comparison (Meyer and Paulay 2005; Hoffmann et al. 2009b). Storage of available information in public databases, and type strains maintained and accessible from culture collections, as well as a consensus in taxonomical classification through the scientific community, are indispensable for precise assignments of species.

At the present time, the trend tends to rely mainly if not exclusively on molecular data to identify biological specimens with the focus on so-called “DNA barcodes”, a term created in 1993 (Arnot et al. 1993). The now well-established Consortium for the Barcode of Life (CBOL, <http://barcoding.si.edu>) is aimed to coordinate the research on DNA barcodes and to establish global standards with an open-access database about species diversity.

The search for the universal barcode marker, which distinguishes all living beings or at least large organismic groups is presently a subject of heavy scientific debate. So far, the most promising barcodes for the identification of animals are sequences of the mitochondrial cytochrome oxidase subunit I (*COI* or *coxI*) (Hebert et al. 2003). *coxI* has been successfully applied in various studies identifying a broad range of taxa (Hebert et al. 2004a, b; Johnson and Cicero 2004; Tavares and Baker 2008). But *coxI* shows also some applicational difficulties, for instance

in the differentiation of parapatric species which do not share a common ecological habitat (Moritz and Cicero 2004; Aliabadian et al. 2009). Additional promising sequences for metazoan phylogenetics target the small ribosomal subunit (16S rDNA), the internal transcribed spacer (ITS), and the cytochrome b (*cob*) (Bradley and Baker 2001; Helbig and Seibold 1999; Lemer et al. 2007; Park et al. 2007; Vences et al. 2005). Although *cox1* was also proven to be suitable for the identification of algae (Saunders 2005), it is not useful for land plants because of the high intra–interspecific variability in the evolutionary rates of the mitochondrial DNA. An applicable DNA barcode marker for land plants is still discussed. The nuclear ITS region, the plastid *trnHspbA* intergenic spacer, and the *rbcL* gene were suggested by several authors (Chase et al. 2005; Kress et al. 2005; Kress and Erickson 2007; Newmaster et al. 2006). For fungi, *cox1* is also proposed and was successfully tested for *Penicillium* (Seifert et al. 2007). But, introns, which were reported occasionally (Woo et al. 2003), or the lack of mitochondrial genomes arising from missing mitochondria in anaerobic gut fungi (Yarlett et al. 1986), as well as non-vertical inheritance of mitochondrial genes caused by parasexuality-driven hyphal anastomoses over the species barrier, disqualifies *cox1* as the universal marker for fungi. However, alternative barcode markers like the widely used internal transcribed spacer (ITS) region of the nuclear ribosomal DNA cluster are in some cases insufficiently variable to reliably separate the species apart (Skouboe et al. 1999). Because of their frequent lack of distinguishable morphological characters, especially fungi necessitate a robust DNA-based identification system. Although molecular identification is well-established for distinctive fungal groups, a standardised protocol which is over-all applicable is still missing.

The aim of the present study is to elucidate common problems in barcoding concerning the eukaryotic kingdom fungi with emphasis on Zygomycetes exemplified with the prominent genera *Mucor* and *Rhizopus*. Traditionally, four major phyla are distinguished within the kingdom Fungi: Chytridiomycota, Zygomycota, Ascomycota and Basidiomycota. But in recent years, it has become evident that this traditional scheme does not reflect the phylogenetic relationships among fungi, especially within the basal fungal lineages. Although the monophyletic phyla Asco- and Basidiomycota are well-characterised sister groups today and combined to the subkingdom of the Dikarya, the classification of the basal fungal lineages is still in flux (Sugiyama 1998; van de Peer et al. 2000; Berbee and Taylor 2001; James et al. 2006; Hibbett et al. 2007). Major changes in recent years were the establishment of the phyla Glomeromycota (Schüßler et al. 2001), Blastocladiomycota (James et al. 2007), and Neocallimastigomycota (Hibbett et al. 2007) formerly embedded in Zygomycota and Chytridiomycota. Both these phyla harbour several important pathogens of plants, fungi, animals, and man, causing chytridiomycoses or zygomycoses. With a presumed 70% increase of zygomycotic infection diseases between the years 1940 and 2000 (Roden et al. 2005), Zygomycetes are of growing medical importance, especially for patients with immunocompromised systems and diabetes mellitus, or for intravenous drug users (e.g. Greenberg et al. 2004; Metellus et al. 2008; Nucci and Marr 2005; Ribes et al. 2000; Walsh et al. 2004). This increase was notably significant even before the beginning of voriconazole prophylaxis and the treatment of aspergillosis infections in immunocompromised patients

(Roden et al. 2005; Rogers 2008; Trifilio et al. 2007). Common zygomycotic infections affect the rhino-orbito-cerebral tract, the respiratory tract, gastrointestinal tract, or skin (Iwen et al. 2007; Roden et al. 2005). Species involved in mycoses belong mainly to the order Mucorales and can be classified to the epidemiologically and clinically important genera *Rhizopus*, *Mucor*, *Lichtheimia* (formerly *Absidia*), *Cunninghamella*, *Rhizomucor*, and *Apophysomyces* (Diwakar et al. 2007; Iwen et al. 2007; de Hoog et al. 2000; Ribes et al. 2000). Because of the growing significance of infections and their different sensibility to antifungal drugs, precise identification down to species level is indispensable (Bal 2006; Cuenca-Estrella et al. 2006; Singh et al. 2005). Comprehensive studies concerning clinically important fungi revealed *Rhizopus arrhizus* (formerly *R. oryzae*), *R. microsporus*, and *Mucor circinelloides* as the most frequent agents of mucormycoses (Alastruey-Izquierdo et al. 2009; Alvarez et al. 2009). Each of these species has a different susceptibility to antifungals (Alastruey-Izquierdo et al. 2009; Almyroudis et al. 2007; Dannaoui et al. 2003). The possibility to identify clinically important Zygomycetes based on DNA markers was successfully demonstrated in recent years (Iwen et al. 2005, 2007; O'Donnell et al. 2001; Schwarz et al. 2006; Voigt et al. 1999; Voigt and Wöstemeyer 2001; White et al. 2006). We want to show the synergistic supplementation of different easy-to-access data aiming at the identification of fungi with emphasis on the mucoralean genera *Mucor* and *Rhizopus*. Although DNA markers usually allow an easier (in theory) distinction of clinically important taxonomic groups, morphology is still essentially required for supporting the species designations and the description of newly identified species (Alastruey-Izquierdo et al. 2010; Hoffmann et al. 2007, 2009b).

## 11.2 Methodical Section

### 11.2.1 Isolation, Cultivation and Maintenance of Strains

A considerable number of soil and air-borne fungi were isolated from Saudi Arabian fruits and soil, Germany, and Austria (Tables 11.1–11.4). Fungal isolates were cultivated for maintenance and isolation of genomic DNA was done on MEX solid media (30 gL<sup>-1</sup> malt extract supplemented with 5 gL<sup>-1</sup> yeast extract and 20 gL<sup>-1</sup> agar). All strains with a FSU number are deposited at the Fungal Reference Centre, University of Jena, and available upon request ([www.prz.uni-jena.de](http://www.prz.uni-jena.de)).

### 11.2.2 Morphological Identification

Morphological identification was performed in following the guidelines of description keys commonly used for species identification and the therein recommended

**Table 11.1** Basidiomycetes, isolated from Saudi Arabian fruits and soil. Because of lacking morphological traits, a secure identification was not possible. Sequence BLAST results of ITS sequences are given, but were not useful for correct species assignments. Taxonomical affiliations for the best BLAST hits are indicated according to the taxonomy at NCBI. All BLAST results belong to: Basidiomycota, Agaricomycotina, Agaricomycetes

FSU-no.	GenBank Acc.no.	ITS sequence BLAST results	BLAST identity (%)	Taxonomical affiliations
6258/ 6280	GQ221186	<i>Bjerkandera adusta</i>	98–100	Polyporales, Coriolaceae
	GQ221187	<i>Thanatephorus cucumeris</i>	98–100	Cantharellales, Ceratobasidiaceae
6263/ 6282	GQ221188 GQ221189	<i>Phlebia radiata</i>	98–100	Corticiales, Corticiaceae
6301/ 6404	GQ221190 GQ221191	<i>Sistotrema brinkmannii</i>	99	Corticiales, Corticiaceae
		<i>Lactarius chrysorrhoeus</i>	99	Russulales, Russulaceae
	GQ221192	<i>Coprinopsis cothurnata</i>	99	Agaricales, Psathyrellaceae
		<i>Merulius tremellosus</i>	97–99	Corticiales, Corticiaceae
6418	GQ221193	<i>Trametes versicolor</i>	98–99	Polyporales, Coriolaceae
		<i>T. ochracea</i>	99	Polyporales, Coriolaceae
		<i>Tricholoma robustum</i>	99	Agaricales, Tricholomataceae
		<i>Phellinus igniarius</i>	98	Hymenochaetales, Hymenochaetaceae

media and methods. For the identification of Zygomycetes the following keys were used: Benjamin (1979), Ellis and Hesseltine (1965, 1966), Hesseltine and Ellis (1961, 1964, 1966), Zycha et al. (1969), Schipper (1973, 1975, 1976, 1984, 1990), Schipper and Stalpers (1984), and Alastruey-Izquierdo et al. (2010). Species of the phyla Asco- and Basidiomycota were identified using Samson and Frisvad (2004), Raper and Fennell (1965), Raper and Thom (1949), Leslie and Summerell (2006), and Wollenweber and Reinking (1935). Some prominent morphological features for differentiation are summarised in Figs. 11.1–11.3.

### 11.2.3 Extraction of Genomic DNA and PCR Amplification

Extraction of genomic DNA and PCR amplification of marker genes were done as described elsewhere (Einax and Voigt 2003). The primers for amplification were ITS1/4 for the internal transcribed spacer regions 1 and 2 (White et al. 1990), cmd5/6 for calmodulin fragments (Hong et al. 2005), and bt2a/b for beta-tubulin fragments (Glass and Donaldson 1995). The amplicons were purified using the adsorption to glass particles described by Vogelstein and Gillespie (1979). Purified fragments were subjected to direct sequencing using the PCR primers as sequencing primers.

**Table 11.2** Ascomycetes, isolated in Saudi Arabia. Accepted identities based on considerations combined from morphological data and sequence BLAST results of ITS, beta-tubulin or calmodulin sequences

FSU-no.	GenBank Acc.no.	Identification based on morphology	Identification verified by sequence BLAST, [BLAST identity]	Final identification
CK1 (9285, 9286, 9306, 9308, 9641, 9653) <sup>a</sup> , 9289 <sup>b</sup> , (9313, 9314, 9315, 9317) <sup>c</sup> 9295 <sup>d</sup>	GQ221095 GQ221096–GQ221104	<i>Acrostagmus</i> sp. <i>Alternaria</i> sp.	ITS: <i>A. luteoalbus</i> [99%] ITS (9285=9286=9289= 9306=9308= 9313=9314=9317=9641=9653 / 9315): <i>Alternaria</i> sp. [99%]	<i>A. luteoalbus</i> <i>Alternaria</i> sp.
9293 <sup>d</sup>	GQ221105, GQ221159	<i>Aspergillus candidus</i> <i>Aspergillus</i> sp.	n.d. ITS: <i>Eurotium chevalieri</i> , <i>A. cristatus</i> , <i>E. anstelodami</i> , <i>A. ruber</i> [98%] Btub: <i>Eurotium chevalieri</i> [100%]	<i>A. candidus</i> <i>A. chevalieri</i>
9429 <sup>f</sup> (6264, 6405) <sup>x</sup>	GQ221106, GQ221160 GQ221107, GQ221161, GQ221087	<i>Aspergillus flavus</i> var. <i>oryzae</i> <i>Aspergillus fumigatus</i>	ITS: <i>A. flavus</i> var. <i>oryzae</i> [99%] Btub: <i>A. flavus</i> var. <i>oryzae</i> [99%] ITS (6405): <i>A. fumigatus</i> [100%] Btub (6264): <i>A. fumigatus</i> [100%] Cmd (6264): <i>A. fumigatus</i> [99%]	<i>A. flavus</i> var. <i>oryzae</i> <i>A. fumigatus</i>
(6276, 6279) <sup>b</sup> 9297 <sup>b</sup> 6408 <sup>h</sup>	GQ221164–GQ221165, GQ221089– GQ221090 GQ221108, GQ221162 GQ221109, GQ221163, GQ221088	<i>Aspergillus niger</i> var. <i>niger</i> <i>Aspergillus sclerotiorum</i> <i>Aspergillus ustus</i>	Btub: <i>A. niger</i> var. <i>niger</i> [99%] Cmd: <i>A. niger</i> var. <i>niger</i> , <i>A. awamori</i> [98%] ITS: <i>A. sclerotiorum</i> , <i>A. persii</i> , <i>A. bridgeri</i> [99%] Btub: <i>A. sclerotiorum</i> , <i>A. persii</i> [97–98%] ITS: <i>A. sclerotiorum</i> , <i>A. ustus</i> [99%] Btub: <i>A. insuetus</i> , <i>A. ustus</i> [96–97%] Cmd: <i>A. insuetus</i> , <i>A. ustus</i> [94–96%] ITS: <i>A. pullulans</i> [100%] ITS: <i>B. heveae</i> [99%]	<i>A. niger</i> var. <i>niger</i> <i>A. sclerotiorum</i> <i>A. ustus</i>
9292 <sup>b</sup> 9320 <sup>c</sup>	GQ221110 GQ221111	<i>Aureobasidium</i> sp. <i>Bipolaris</i> sp. <i>Botrytis</i> sp.	ITS: <i>A. pullulans</i> [100%] ITS: <i>B. heveae</i> [99%]	<i>A. pullulans</i> <i>B. heveae</i> <i>B. cinerea</i>

(6277, 6296, 6297, 6298, 6300, 6409) <sup>h</sup> , (9640, 9647) <sup>f</sup> , 6289 <sup>x</sup>	GQ221112–GQ221119, GQ221166–GQ221171		ITS=6277=6296=6297=6300; 6289=6298=6409=9640=9647; <i>B. cinerea</i> , <i>B. fabae</i> , <i>Sclerotinia sclerotiorum</i> [99%]
(6270, 6290, 6292, 6295) <sup>h</sup>	GQ221120–GQ221123, GQ221091	<i>Chaetomium</i> sp.	ITS (6295=6270=6290=6292); <i>C. globosum</i> [100%]
9312 <sup>c</sup>	GQ221124	<i>Cochliobolus</i> sp.	Cmd (6270); <i>C. globosum</i> [99%]
9290 <sup>e</sup>	GQ221125, GQ221172	<i>Cochliobolus</i> sp.	ITS: <i>C. kusanoi</i> , <i>Drechslera portulacae</i> [94%]
9674 <sup>a</sup>	GQ221126	<i>Chaetomiaceae</i>	ITS: <i>C. spicifer</i> [100%] Btub; <i>C. sp.</i> [90%]
9309 <sup>a</sup>	GQ221127, GQ221173, GQ221092	<i>Emericella quadrilineata</i>	ITS: <i>Corynascus kawaiensis</i> [99%] ITS: <i>E. quadrilineata</i> , <i>E. nidulans</i> , <i>Emericella miyajii</i> [100%] Btub: <i>E. miyajii</i> , <i>A. parvathecicus</i> , <i>E. quadrilineata</i> [99–100%] Cmd: <i>E. quadrilineata</i> [100%]
9303 <sup>a</sup>	GQ221128	<i>Engyodontium</i> sp.	ITS: <i>E. album</i> [96%]
9305 <sup>a</sup>	GQ221129	<i>Exserohilum</i> sp.	ITS: <i>Exserohilum rostratum</i> [99%]
(8671, 9302, 9427, 9428, 9643, 9298) <sup>a</sup> , (9294, 9300) <sup>b</sup> , 6261 <sup>e</sup> , 9296 <sup>f</sup> , 9642 <sup>g</sup> , (9301, 9304) <sup>j</sup>	GQ221130–GQ221138, GQ221140, GQ221141, GQ221175–GQ221176	<i>Fusarium</i> sp.	ITS: diverse <i>Fusarium</i> sp. [98–100%] Btub (9298, 9304): diverse <i>Fusarium</i> sp. [94–99%] <sup>z</sup>
9311 <sup>d</sup>	GQ221139, GQ221174	<i>Fusarium oxysporum</i>	ITS: <i>F. solani</i> , <i>F. oxysporum</i> [99–100%] Btub: <i>F. solani</i> , <i>F. oxysporum</i> [100%] n.d.
8673 <sup>g</sup> , 9639 <sup>f</sup>		<i>Geotrichum candidum</i> var. <i>citri-aurantii</i> n.d.	<i>G. candidum</i> var. <i>citri-aurantii</i>
9310 <sup>a</sup>	GQ221142	<i>Paecilomyces</i> sp.	ITS: <i>Microsphaeropsis arundinis</i> [100%]
9299 <sup>d</sup>	GQ221177		Btub: <i>P. variotii</i> [97%]

(continued)

Table 11.2 (continued)

FSU-no.	GenBank Acc.no.	Identification based on morphology	Identification verified by sequence BLAST, [BLAST identity]	Final identification
(6268, 6267, 6406) <sup>h</sup> , 6265 <sup>x</sup>	GQ221143–GQ221146, GQ221178–GQ221181	<i>Penicillium chrysogenum</i>	ITS: <i>P. chrysogenum</i> [100%] Btub: <i>P. chrysogenum</i> [98–100%]	<i>P. chrysogenum</i>
6269 <sup>h</sup>	GQ221147	<i>Penicillium</i> sp.	ITS: <i>P. expansum</i> [99%]	<i>P. expansum</i>
6293 <sup>h</sup> , 6294 <sup>x</sup>	GQ221148	<i>Penicillium molle</i>	ITS: diverse <i>Penicillium</i> sp. [100%] <sup>3</sup>	<i>P. molle</i>
(6278, 6281) <sup>h</sup>	GQ221149–GQ221150, GQ221182–GQ221183, GQ221093–GQ221094	<i>Penicillium</i> sp.	ITS: <i>P. commune</i> , <i>P. griseoroseum</i> , <i>P. solitum</i> var. <i>crustosum</i> , <i>P. italicum</i> [99%] Btub: <i>P. solitum</i> var. <i>crustosum</i> [98–100%] Cmd: <i>P. solitum</i> var. <i>crustosum</i> , <i>P. hirsutum</i> var. <i>allii</i> [99%]	<i>P. solitum</i> var. <i>crustosum</i>
8674 <sup>a</sup>	GQ221151	<i>Pestalotiopsis</i> sp.	ITS: <i>P. clavisporea</i> , <i>P. photiniae</i> [100%]	<i>Pestalotiopsis</i> sp.
9307 <sup>a</sup>	GQ221152	<i>Cochliobolus</i> sp.	ITS: <i>Pseudocochliobolus verruculosus</i> [100%]	<i>P. verruculosus</i>
9646 <sup>b</sup>	GQ221153	<i>Cladosporium</i> sp.	ITS: <i>Retrocois fusiformis</i> [100%]	<i>R. fusiformis</i>
(9425, 9426, 9431) <sup>a</sup>	GQ221154–GQ221156, GQ221184–GQ221185	<i>Trichoderma</i> sp.	ITS: diverse <i>Trichoderma</i> sp. [98–100%] Btub (9425, 9431): <i>Trichoderma viride</i> [93%] ITS: diverse <i>Ulocladium</i> sp. [99%]	<i>Trichoderma</i> sp. <i>Ulocladium</i> sp.
9287 <sup>b</sup> , 9319 <sup>c</sup>	GQ221157–GQ221158	<i>Ulocladium</i> sp.	ITS: diverse <i>Ulocladium</i> sp. [99%]	<i>Ulocladium</i> sp.

<sup>1</sup>No adequate reference sequence in database for *Botrytis fabae*, but morphological clearly *B. cinerea*

<sup>2</sup>All these *Fusarium* species belong to different species with 1–20% sequence differences based on an ITS1-5.8S rDNA-ITS2 alignment (data not shown)

<sup>3</sup>No ITS sequence for *Penicillium molle* available

Substrates of isolation: (a) soil, (b) air, (c) wheat, (d) floor, (e) date palm, (f) guava, (g) apricot, (h) *Calotropis procera*, (j) banana, (x) unknown



**Table 11.3** Zygomycetes, isolated in Saudi Arabia. Accepted identities based on considerations combined from morphological data and sequence BLAST results of ITS sequences

FSU-no.	GenBank Acc. no.	Identification based on morphology	Identification verified by sequence BLAST, [BLAST identity]	Final identification
(6254, 9673) <sup>a</sup> , 6256 <sup>b</sup>	GQ221194– GQ221196	<i>Actinomucor elegans</i>	<i>A. elegans</i> [99%]	<i>A. elegans</i>
(6257, 6259) <sup>a</sup> , 9637 <sup>c</sup>	GQ221197– GQ221199	<i>Mucor circinelloides</i> f. <i>griseo-cyanus</i>	<i>M. circinelloides</i> [99–100%]	<i>M. circinelloides</i> f. <i>griseo-cyanus</i>
9654 <sup>c</sup>	GQ221200	<i>Mucor hiemalis</i>	<i>Rhizomucor variabilis</i> , <i>M. circinelloides</i> , <i>M. hiemalis</i> , <i>M. racemosus</i> , [98–99%]	<i>M. hiemalis</i>
9635 <sup>a</sup>	GQ221201	<i>Mucor varians</i>	<i>Rhizomucor variabilis</i> , <i>M. circinelloides</i> , <i>M. hiemalis</i> , <i>M. racemosus</i> , [98–99%]	<i>M. varians</i>
(6255, 6262, 9651, 9655) <sup>a</sup> , 9648 <sup>d</sup> (6253, 6266) <sup>x</sup>	GQ221202– GQ221207	<i>Rhizopus arrhizus</i> var. <i>arrhizus</i>	<i>R. arrhizus</i> var. <i>arrhizus</i> [100%]	<i>R. arrhizus</i> var. <i>arrhizus</i>

Substrates of isolation: (a) Soil, (b) Date palm, (c) Poultry farm soil, (d) apricot, (x) Unknown

### 11.2.4 The Fungal Subphylum Mucoromycotina

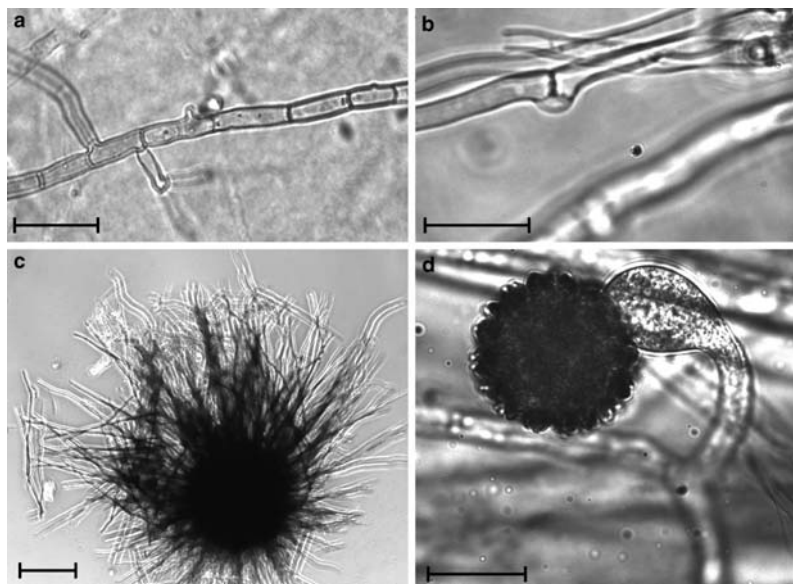
Out of ten families of the order Mucorales (Mucoromycotina, “Zygomycota”) species representatives for 26 genera were analysed on the basis of sequences of the 18S rDNA, 28S rDNA, actin (*act*), and translation elongation factor 1alpha (*tef*). The sequences were retrieved from Genbank (Table 11.5) and subjected to maximum parsimony, maximum likelihood, Bayesian inference, and distance based phylogenetic reconstructions (Fig. 11.4).

### 11.2.5 Reconstruction of Multigene Phylogenetic Trees

Single alignments were carried out using ClustalX version 1.83 (Higgins and Sharp 1988, 1989; Thompson et al. 1997). The alignment consists of 41 taxa and 3,503 characters (1,215 characters for 18S rDNA, 389 characters for 28S rDNA, 807 characters for *act*, and 1,092 characters for *tef*). Bayesian inference with MrBayes v3.0b4 (Huelsenbeck and Ronquist 2001; Ronquist and Huelsenbeck 2003) was initiated from a random starting tree. Two runs with each four chains were

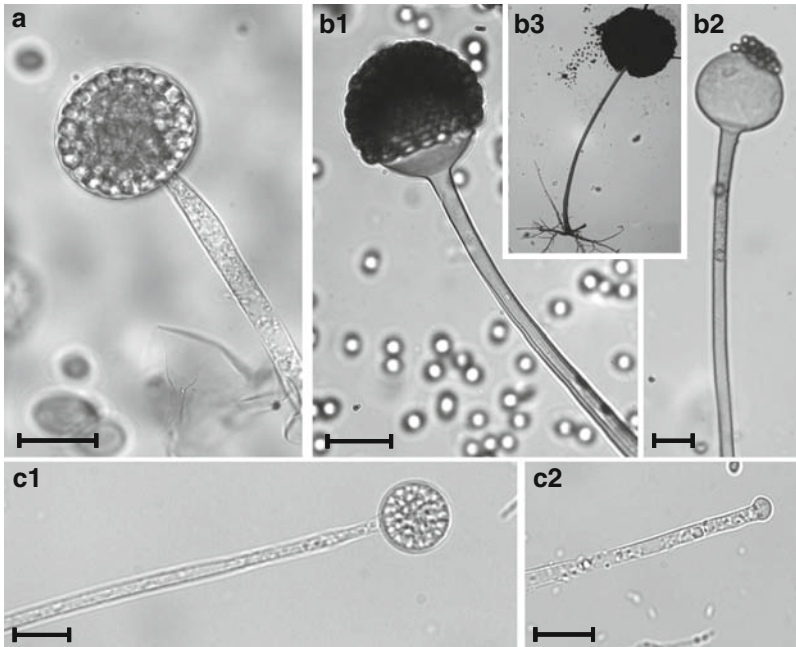
**Table 11.4** Zygomycetes, isolated from various substrates in Europe. Accepted identities based on considerations combined from morphological data and sequence BLAST results of ITS sequences

FSU-no.	GenBank Acc. no.	Origin of isolation (isolated by)	Identification based on morphology	Identification verified by sequence BLAST, [BLAST identity]	Final identification
6510-6516, 6521, 6526	GQ221208–GQ221209	Waddenmeer, Vlieland, The Netherlands	<i>Cunninghamella echinulata</i>	FSU6521, 6526 diverse <i>Cunninghamella</i> sp. [89–92%]	<i>C. echinulata</i>
6250, 6520, 6523	GQ221210–GQ221211, GQ221217	6250: human skin, Germany; 6520: cow; 6523: dung of pigeon, Innsbruck, Austria	<i>Lichtheimia corymbifera</i>	<i>L. corymbifera</i> [98–100%]	<i>L. corymbifera</i>
6524	GQ221212	soil, Geisenheim, Germany	<i>Morierella alpina</i>	<i>M. alpina</i> [100%]	<i>M. alpina</i>
6251, 6252, 6518	GQ221218–GQ221219, GQ221213	6251, 6252: human ear, nail, Germany; 6518: Austria	<i>Mucor circinelloides</i> f. <i>circinelloides</i>	<i>M. circinelloides</i> [99%]	<i>M. circinelloides</i> f. <i>circinelloides</i>
6517	GQ221214	Snail, Austria	<i>Mucor fragilis</i>	<i>M. fragilis</i> [99%]	<i>M. fragilis</i>
6519, 6530	GQ221215, GQ221220	6519: soil, Geisenheim, Germany; 6530: human sole of foot, Germany	<i>Mucor hiemalis</i>	<i>M. hiemalis</i> [99–100%]	<i>M. hiemalis</i>
6274	GQ221221	Human nail, Germany	<i>Mucor plumbeus</i>	<i>M. plumbeus</i> [98%]	<i>M. plumbeus</i>
6527	GQ221216, GQ221222	Soil, Innsbruck, Austria	<i>Umbelopsis isabellina</i>	n.d.	<i>U. isabellina</i>
6522, 6529	GQ221216, GQ221222	6522: soil, Martell, Italy; 6529: human nail, Germany	<i>Zygorhynchus moelleri</i>	<i>Z. moelleri</i> [99%]	<i>Z. moelleri</i>



**Fig. 11.1** Light microscopic images of several easy-for-differentiation characters typically for the fungal phyla. (a) regularly septated mycelium typical for Asco- and Basidiomycetes; (b) clamp of basidiomycetes; (c) Perithecium, the sexual reproductive structure of some Ascomycetes (*Chaetomium* sp.); (d) Zygospore, the sexual reproductive structure of Zygomycetes. Scale bar: (a–b, d) 20  $\mu$ m; (c) 100  $\mu$ m

conducted for 5,000,000 generations with samples from every 5,000 generation. After discarding the first 25% of the generated trees (burn-in) the consensus tree was calculated using the halfcompat option. Posterior probabilities (in percent) at the nodes represent node confidence values. The Bayesian inferred tree is presented in Fig. 11.4. Distance analysis with distance measure Jukes-Cantor assuming minimum evolution was done with PAUP\* v4.0b10 (Swofford 1998); negative branch lengths were prohibited. Bootstrap supports (BS) (Felsenstein 1985; 50% majority rule) were obtained by 1,000 replicates and Jukes-Cantor distances. In Maximum Parsimony, the starting tree was obtained by stepwise addition of the sequences. The sequences were added on a simple basis and one tree was held at each step. Tree-bisection-reconnection (TBR) was the branch-swapping algorithm. Steepest descent was not in effect. “MulTrees” option was in effect. Two trees were retained. The bootstrap support (BS) was calculated with fast-heuristic search and 1,000 replicates. Maximum Likelihood was also carried out using a heuristic search. The number of substitution types was 2 (HKY85 variant) as was the transition/transversion ratio. Assumed nucleotide frequencies were empirical. A molecular clock was not enforced. The starting branch lengths were obtained by the Rogers–Swofford approximation method (Rogers and Swofford 1998). Using stepwise addition of the sequences and choosing as-is for the addition, the starting tree was obtained. TBR was the branch-swapping algorithm. Steepest descent was not in

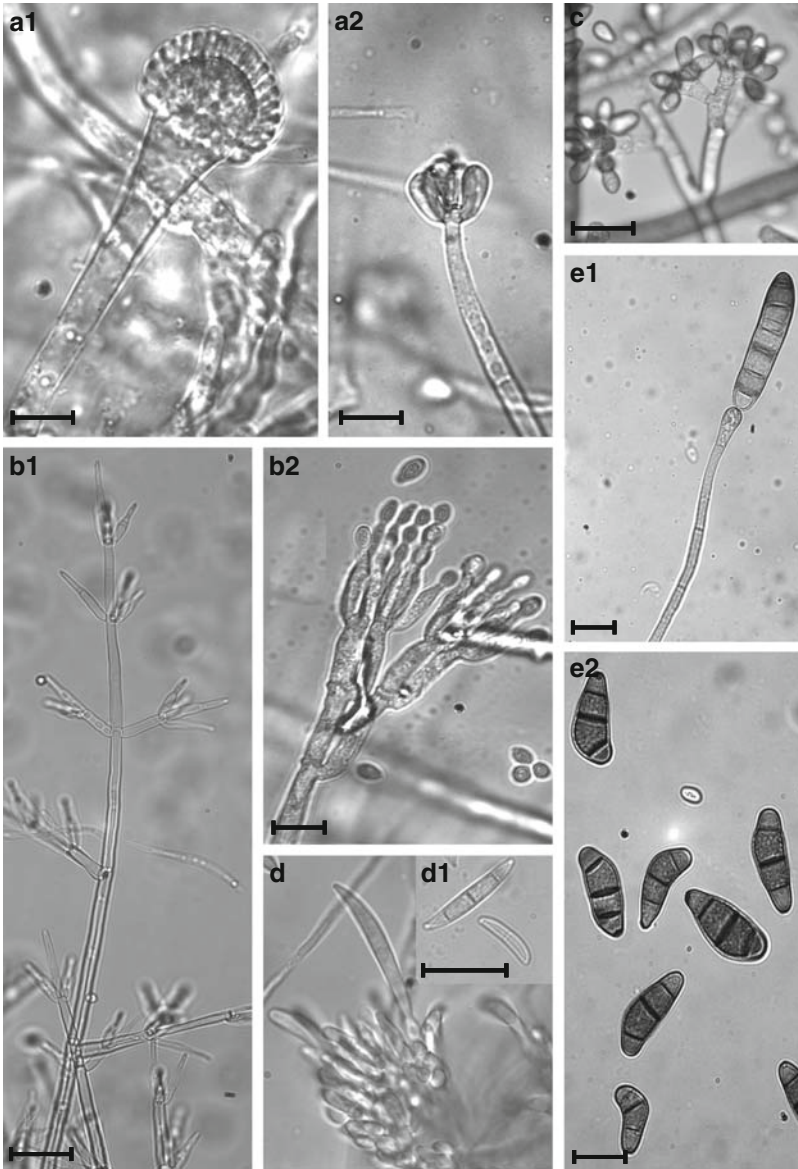


**Fig. 11.2** Light microscopic images of asexual reproductive structures of zygomycetes. (a) sporangium with endogenous mitospores (*Mucor circinelloides*); (b1) apophysate sporangium of *Rhizopus arrhizus*; (b2) remaining columella after spore release of *R. arrhizus*; (b3) Sporangium of *R. arrhizus* arising opposite rhizoids; (c) Sporangium and columella of *Umbelopsis isabellina*, a fungus of the phylogenetic basal family Umbelopsidaceae (Fig. 11.4). Scale bar: (a–b) 20  $\mu\text{m}$ ; (c) 10  $\mu\text{m}$

effect. “MulTrees” option was in effect. The bootstrap support (BS) was calculated with fast-heuristic search and 100 replicates. Trees and Bootstrap supports of parsimony, likelihood, and distance analyses supported the topology and branch support from the Bayesian inference analyses, and are therefore not shown. BS values equal or greater than 75% in all analyses are indicated as bold branches in Fig. 11.4.

### 11.2.6 Analysis of the Internal Transcribed Spacer Regions 1 and 2 Including 5.8S rDNA

For several isolates of *Rhizopus stolonifer*, *R. arrhizus*, and *Mucor circinelloides* ITS1-5.8S rDNA-ITS2 sequences were generated within this study and deposited in GenBank as accession numbers AM933543-55, AM937531-2, GQ221197-99, GQ221202-07, GQ221218-19, GQ221213. One sequence for *Lichtheimia corymbifera* was generated as outgroup taxon (AM937530). The following sequences



**Fig. 11.3** Light microscopic images of diverse asexual reproductive structures and conidia observed in Ascomycetes. (a) phialides arising directly from the conidiogenous cell (**a1** *Aspergillus fumigatus*, **a2** *Stachybotrys* sp.); (b) or phialides arising from metulae (**b1** *Acrostalagmus luteoalbus*, **b2** *Penicillium* sp.); c) polyblastic conidiogenesis of *Botrytis cinerea*; (d) conidiophores arising from aggregated hyphae, the sporodochia of *Fusarium* sp., macro- and microconidium (**d1**); (e) septated conidia of *Bipolaris heveae* (**e1**) and *Cochliobolus verruculosus* (**e2**). Scale bars: (a, b2) 10 µm; (b1, c, d1, e) 20 µm

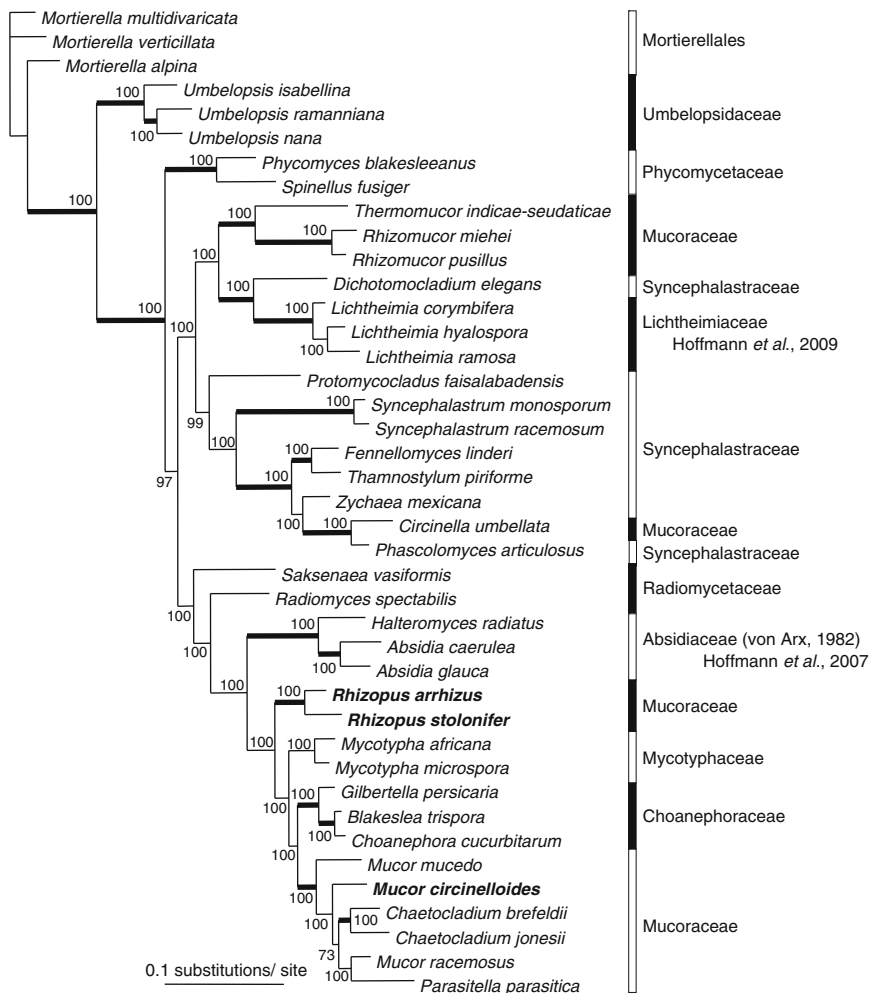
**Table 11.5** Sequences retrieved from GenBank for the reconstruction of phylogenetic trees (Fig. 11.4)

Strain	GenBank accession nos.			
	ACT	TEF	18S rDNA	28S rDNA
<i>Absidia caerulea</i> <sup>NT</sup>	AJ287133	AF157226	AF113405	AF113443
<i>Absidia glauca</i>	AJ287135	X54730	AF157118	AF157172
<i>Blakeslea trispora</i>	AJ287143	AF157235	AF157124	AF157178
<i>Chaetocladium brefeldii</i>	AJ287144	AF157236	AF157125	AF157179
<i>Chaetocladium jonesii</i>	AJ287145	AF157237	AF157126	AF157180
<i>Choanephora cucurbitarum</i>	AJ287147	AF157239	AF157127	AF157181
<i>Circinella umbellata</i>	AJ287148	AF157240	AF157128	AF157182
<i>Dichotomocladium elegans</i>	AJ287153	AF157245	AF157131	AF157185
<i>Fennellomyces linderi</i> <sup>T</sup>	AJ287158	AF157250	AF157135	AF157189
<i>Gilbertella persicaria</i>	AJ287159	AF157251	AF157136	AF157190
<i>Halteromyces radiatus</i> <sup>T</sup>	AJ287161	AF157253	AF157138	AF157192
<i>Lichtheimia corymbifera</i>	AJ287134	AF157227	AF113407	AF113445
<i>Lichtheimia hyalospora</i> <sup>T</sup>	AJ287132	AF157225	AF157117	AF157171
<i>Lichtheimia ramosa</i>	EU826377	EU826382	EU826361	EU826370
<i>Mortierella alpina</i>	EU736236	EU736263	EU736290	EU736317
<i>Mortierella multidivariata</i>	AJ287168	AF157260	AF157144	AF157198
<i>Mortierella verticillata</i>	AJ287170	AF157262	AF157145	AF157199
<i>Mucor circinelloides</i>	AJ287173	AF157264	AF113427	AF113467
<i>Mucor mucedo</i>	AJ287176	AF157267	X89434	AF113470
<i>Mucor racemosus</i> <sup>T</sup>	AJ287177	AF157268	AF113430	AF113471
<i>Mycotypha africana</i> <sup>IT</sup>	AJ287180	AF157271	AF157147	AF157201
<i>Mycotypha microspora</i>	AJ287181	AF157272	AF157148	AF157202
<i>Parasitella parasitica</i>	AJ287182	AF157273	AF157149	AF157203
<i>Phascolomyces articulatus</i> <sup>T</sup>	AJ287183	AF157274	AF157150	AF157204
<i>Phycomyces blakesleeanus</i>	AJ287184	AF157275	AF157151	AF157205
<i>Protomycoladus faisalabadensis</i>	AJ287189	AF157280	AF157156	AF157210
<i>Radiomyces spectabilis</i>	AJ287190	AF157281	AF157157	AF157211
<i>Rhizomucor miehei</i>	AJ287191	AF157282	AF113432	AF113473
<i>Rhizomucor pusillus</i>	AJ287192	AF157283	AF113433	AF113474
<i>Rhizopus arrhizus</i>	AJ287198	AF157289	AF113440	AF113481
<i>Rhizopus stolonifer</i>	AJ287199	AF157290	AF113441	AF113482
<i>Saksenaea vasiformis</i> <sup>T</sup>	AJ287200	AF157291	AF113442	AF113483
<i>Spinellus fusiger</i>	AJ287201	AF157292	AF157159	AF157213
<i>Synccephalastrum monosporum</i>	AJ287203	AF157294	AF157161	AF157215
<i>Synccephalastrum racemosum</i>	AJ287204	AF157295	X89437	AF113484
<i>Thamnostylum piriforme</i>	AJ287207	AF157298	AF157164	AF157218
<i>Thermomucor indicae-seudaticae</i> <sup>T</sup>	AJ287208	AF157299	AF157165	AF157219
<i>Umbelopsis isabellina</i>	AJ287209	AF157300	AF157166	AF157220
<i>Umbelopsis nana</i>	AJ287210	AF157301	AF157167	AF157221
<i>Umbelopsis ramanniana</i>	AJ287166	AF157258	X89435	AF113463
<i>Zychaea mexicana</i> <sup>T</sup>	AJ287212	AF157303	AF157169	AF157223

T-type strain; IT-isotype strain; NT-neotype strain

were retrieved from GenBank as references: AB113022 and AB113023 (*R. stolonifer* var. *stolonifer* CBS150.83 and CBS609.82), DQ119009 (*R. microsporus* var. *chinensis*, CBS631.82 type), DQ119011 (*R. microsporus* var. *oligosporus* CBS339.62), DQ119014 (*R. microsporus* var. *rhizopodiformis* IP676.72), DQ119010





**Fig. 11.4** Bayesian inferred phylogram based on aligned nucleotide sequences encoding actin, translation elongation factor 1alpha, small and large subunit ribosomal RNA from 38 mucoralean fungi with 3 species of the Mortierellales as outgroup (see Table 11.5). Family affiliations are according to Kirk et al. (2008), Hoffmann et al. (2007, 2009b). Branch support values (posterior probabilities) are given and branch support values equal or greater than 75% in all analyses are indicated as *bold branches*

(*R. microsporus* var. *microsporus* IP1124.75), DQ641325 (*R. caespitosus* CBS427.87), DQ641324 (*R. homothallicus* CBS336.62 type), DQ119031 (*R. arrhizus* var. *arrhizus* CBS112.07 type), AY213687 (*R. schipperae* CBS138.95 type), AB113016 (*R. sexualis* CBS336.39 type), DQ118991 (*M. circinelloides* f. *circinelloides* CBS195.68 neotype), AJ271061 (*M. circinelloides* f. *lusitanicus* CBS277.49), and DQ118984 (*Lichtheimia corymbifera* CBS120805). Furthermore, appropriate

sequences were retrieved from the genome projects of *M. circinelloides* f. *lusitanicus* CBS277.49 (scaffold 3 and 12, as of March-29-2009; <http://www.jgi.doe.gov>) and *Rh. arrhizus* var. *arrhizus* (supercontig 3.6 2078935-2079563 and 2042075-2042703, as of March-29-2009; [http://www.broad.mit.edu/annotation/genome/rhizopus\\_oryzae](http://www.broad.mit.edu/annotation/genome/rhizopus_oryzae)). The phylogenetic analysis of the ITS sequences was based on the Bayesian inference and is shown in Fig. 11.5.

### **11.2.7 Random Amplified DNA Polymorphisms**

Genomic DNA from several isolates of *R. stolonifer*, *R. arrhizus*, and *M. circinelloides* (Table 11.6) were amplified with the primers V6 (Lopandic et al. 1996) and M13 (O'Donnell et al. 1999). The random amplified DNA polymorphism (RAPD) profiles obtained were manually transferred into a binary data matrix (0 and 1 for absence and presence of RAPD bands) and subjected to distance based UPGMA analysis using PAUP\* v4.0b10 (Swofford 1998). The combined matrices of both RAPD analyses consist of 49 characters in the case of *Mucor* and 68 characters for *Rhizopus*. RAPD analyses and corresponding trees are displayed in Figs. 11.6 and 11.7.

### **11.2.8 Sequence Similarity Matrices for *Rhizopus* and *Mucor* sp.**

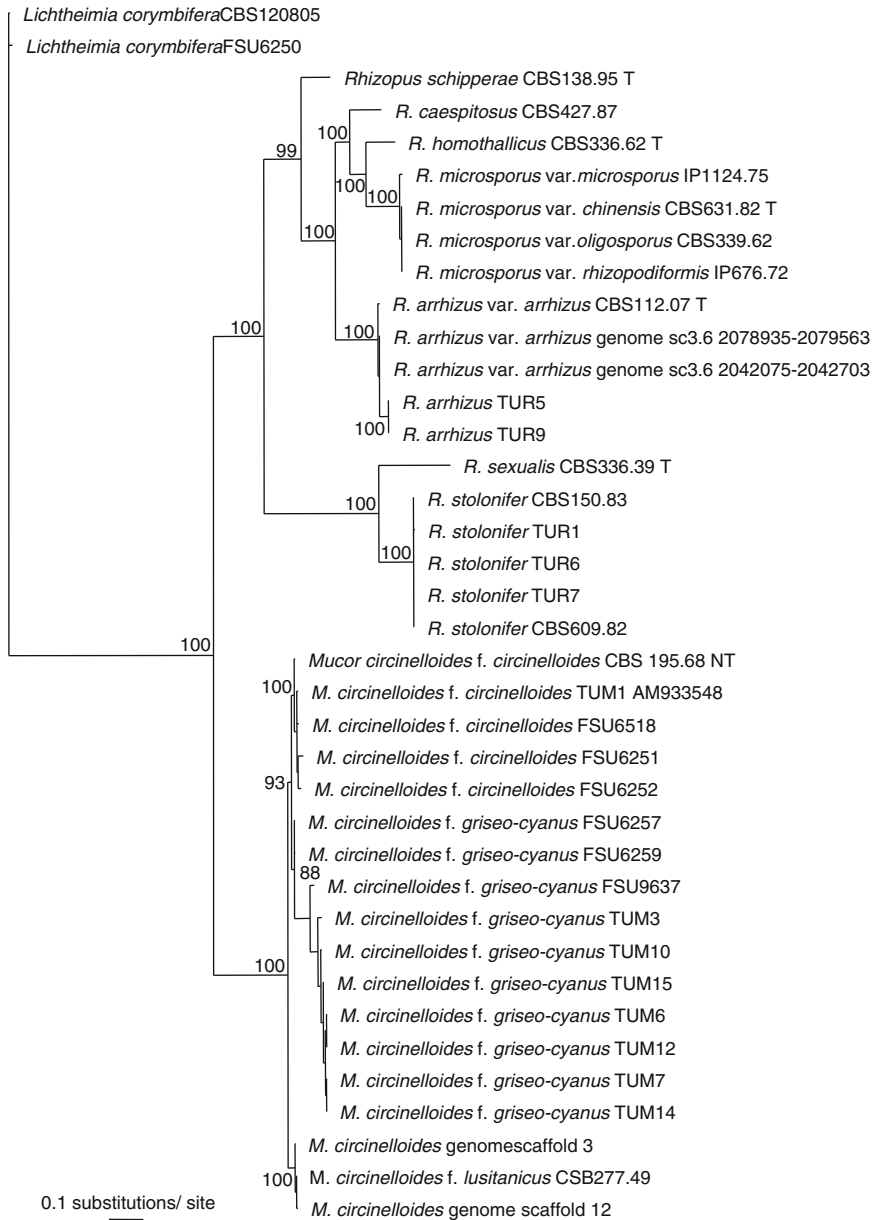
Sequence similarity matrices were generated from the alignments, which were also used for the phylogenetic reconstructions. But it turned out that missing characters need to be omitted, and thus the aligned DNA matrix needs to be shortened to equal ends (Tables 11.7 and 11.8).

## **11.3 Results and Discussion**

### **11.3.1 Diversity and Coarse Scale Identification of Fungal Species Isolated From Saudi Arabian Soil and Fruits**

A total of 120 different fungi were isolated, divided into Basidiomycota with 8 isolates, Ascomycota with 75 isolates out of 20 different genera with at least 26 species, and “Zygomycota” with 37 isolates belonging to 8 different genera and 13 species (Tables 11.1–11.4). Each phylum is characterised by specific features allowing a relative rough and easy assignment of its species. Often no more than a light microscope is necessary for the first rough identification. More or less

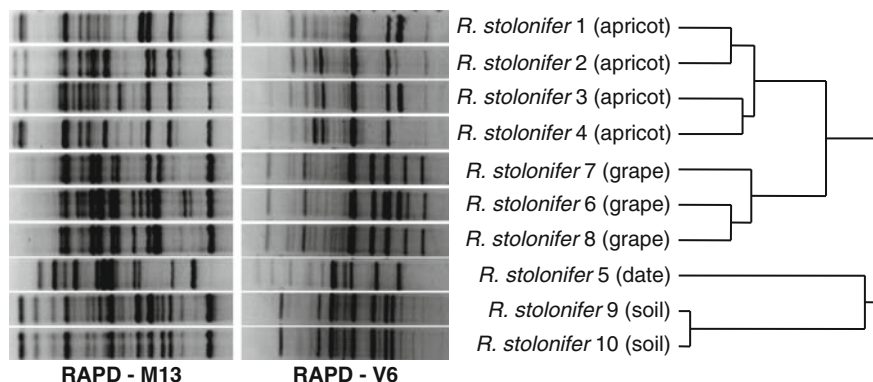




**Fig. 11.5** Bayesian inferred phylogram of aligned ITS sequences from different species and subspecies of *Mucor circinelloides* and *Rhizopus* sp. Branch support values are Posterior Probabilities. Strain numbers are given. Type or neotype strains are indicated by "T" or "NT"

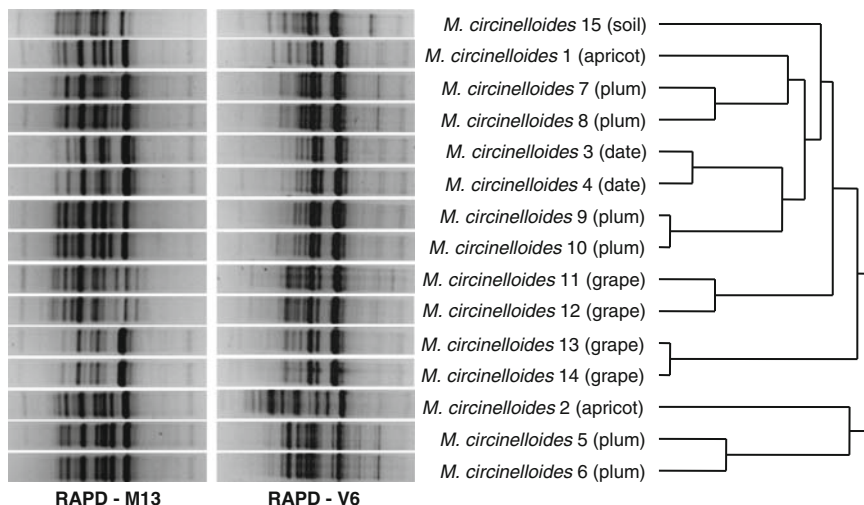
**Table 11.6** *Rhizopus* sp. and *Mucor circinelloides* strains isolated from different substrates

Species	Isolation code	Substrate
<i>R. arrhizus</i>	TUR5	Date
<i>R. arrhizus</i>	TUR9-10	Soil
<i>R. stolonifer</i>	TUR1-4	Apricot
<i>R. stolonifer</i>	TUR6	Plum
<i>R. stolonifer</i>	TUR7-8	Grape
<i>M. circinelloides</i>	TUM1-2	Apricot
<i>M. circinelloides</i>	TUM3-4	Date
<i>M. circinelloides</i>	TUM5-10	Plum
<i>M. circinelloides</i>	TUM11-14	Grape
<i>M. circinelloides</i>	TUM15	Soil



**Fig. 11.6** RAPD analyses of several isolates of *Rhizopus* sp. from Saudi Arabia. The profiles of two different primers, M13 and V6, were combined and subjected to distance based UPGMA analysis. The combined matrix consists of 68 characters

regularly septated mycelia are typical for the hyphal growth of Asco- and Basidiomycota (Fig. 11.1a) in contrast to the nearly unseptated (but if septae are present, than irregularly septated) mycelium of the “Zygomycota”. Eponymous for each phylum are the sexual structures of reproduction, namely basidium, ascus (Fig. 11.1c), and zygospore (Fig. 11.1d). For microscopic fungi with only a limited number of distinctive, phylogenetic relevant morphological characters, the asexually developed mitospore- and their associated structures, possess great diagnostic importance. Although the Basidiomycetes isolated within this study did not form any distinctive features, e.g. anamorphic structures or even fruiting bodies in culture, the occurrence of regularly septated mycelium with clamps was diagnostic for dikaryotic mycelia of the Basidiomycetes (Fig. 11.1a, b). Because of the lack of suitable morphological parameters, a continuing morphological identification was not possible for any of the basidiomycetous isolates. A more detailed identification was attempted using nucleotide sequence data of the nuclear ITS region. Three



**Fig. 11.7** RAPD analyses of several isolates of *Mucor circinelloides* from Saudi Arabia. The profiles of two different primers, M13 and V6, were combined and subjected to distance based UPGMA analysis. The combined matrix consists of 49 characters

isolates could be assigned to order and family level, and with good BLAST results to the species level, namely *Phlebia radiata* and *Merulius tremellosus*. (Table 11.1). For both species, the BLAST search was unequivocal for the genus level, but because of the lack of reliable reference sequences, the species level delimitation remains still somewhat uncertain. The other five isolates could not be assigned by ITS to order or below-order level. As a result, neither ITS sequences nor morphological traits are sensitive enough to differentiate between the anamorphic stages of basidiomycetes, if obvious distinctive features of the hyphae are missing. For that purpose the development of alternative gene markers are mandatory.

Asco- and Zygomycetes differ in their type of mitospore formation. An exogenous sporulation is typical for Ascomycetes but atypical for Zygomycetes. The latter ones produce their mitospores endogenously within sporangia, sporangiola, and merosporangia. The sporangia in the order Mucorales are more or less globose (to subglobose) with a distinctive columella of varying size and shape (Fig. 11.2). The columella is synapomorphic for the Mucorales (Voigt et al. 2009).

One of the most prominent exogenous spore disposals is the delimitation from special conidiogenous cells, the phialides in Ascomycetes. Phialides arise either directly from the conidiogenous cell (Fig. 11.3a) or from metulae (Fig. 11.3b). Conidial disposal can also take part from polyblastic conidiogenous cells, which arrange terminally on tree-like branches (Fig. 11.3c). Other ascomycetes bear their conidiophores on aggregated hyphae, the sporodochia (Fig. 11.3d). The ascomycetous mitospores appear in various shapes, types, and cellular integrities. While the



**Table 11.8** Sequence identity matrix of ITS sequences from different isolates of *Mucor circinelloides*

	<i>M. c. f. l.</i> genome	<i>M. c. f. l.</i> neotype	<i>M. c. f. c.</i> isolate 1	<i>M. c. f. c.</i> FSU6251	<i>M. c. f. c.</i> FSU6252	<i>M. c. f. g-c.</i> isolate 3	<i>M. c. f. g-c.</i> iso.6././..15	<i>M. c. f. g-c.</i> FSU6257	<i>M. c. f. g-c.</i> FSU6259	<i>M. c. f. g-c.</i> FSU9637
<i>M. c. f. lusitanicus</i> genome	ID									
<i>M. c. f. circinelloides</i> NT	95	ID								
<i>M. c. f. circinelloides</i> isolate 1	96	100	ID							
<i>M. c. f. circinelloides</i> FSU6251	94	97	98	ID						
<i>M. c. f. circinelloides</i> FSU6252	95	99	99	97	ID					
<i>M. c. f. griseo-</i> <i>cyanus</i> isolate 3	92	95	95	93	94	ID				
<i>M. c. f. g-c.</i> iso. 6,7,10,12,14,15	91	94	94	92	93	98	ID			
<i>M. c. f. griseo-</i> <i>cyanus</i> FSU6257	96	98	98	96	97	95	94	ID		
<i>M. c. f. griseo-</i> <i>cyanus</i> FSU6259	96	99	99	96	98	96	94	99	ID	
<i>M. c. f. griseo-</i> <i>cyanus</i> FSU9637	96	98	98	96	96	95	95	99	99	ID

mitospores of the ascomycetes can be uni- or multicellular, septated or unseptated (Figs. 11.3d1 and e), the mitospores of the zygomycetes are always unicellular and unseptated. On the basis of the anatomy of 75 ascomycete isolates, 74 (99%) could be identified to genus level, but only 43 (57%) could be identified to species level. From 64 species the ITS region, from 27 species the beta-tubulin gene, and from 8 species the calmodulin gene were sequenced. Those 99 sequences were subjected to BLAST searches. In all cases an identification of the genus was possible. An assignment to species level was possible for 56% of the ITS sequences, 82% for the nucleotide sequences encoding beta-tubulin, and 100% for those encoding calmodulin. Consequently, the application of the ITS as barcode marker is ambivalent. While ITS works nicely for molecular barcoding of the ascomycetous genera *Trichoderma*, *Hypocrea*, or *Trichophyton* (Druzhinina et al. 2005; Summerbell et al. 2007), it is not variable enough to distinguish between species in the genera *Penicillium* (Skouboe et al. 1996, 1999) and *Fusarium* (possessing non-orthologous copies of ITS2, O'Donnell and Cigelnik 1997; O'Donnell et al. 1998). In *Aspergillus*, the ITS is quite useful to separate different sections from each other but also not useful to distinguish between species in *Aspergillus* (Balajee et al. 2007). Obviously, the species delimitations are narrower than in other genera. Alternative barcode markers were evaluated and successfully applied. These are partial sequences of the gene encoding translation elongation factor 1alpha (*tef*) for *Fusarium* (Geiser et al. 2004) and the genes encoding beta-tubulin or calmodulin for the most studied ascomycetous genera (Geiser et al. 2007; Hong et al. 2006; Samson et al. 2004).

For Zygomycetes, the situation is somewhat different. Here the morphological markers are discriminative enough to gain a proper above and below species-level identification for all isolates. On the other hand, the ITS sequences facilitated a proper identification of genera, but not of species. Only 80% zygomycetes could be reliably identified down to the species level. The missing fifth (20%) of misapplied classifications occurred because of (1) missing reference material (e.g. for *M. varians* and *M. circinelloides* f. *griseo-cyanus*), or (2) morphologically problematic reference and type strains (FSU9654; *M. hiemalis* and *Rhizomucor variabilis* are morphologically quite similar; see discussion in Hoffmann et al. 2009a). But by carefully judging these possible problems, ITS possesses a high sensitivity and is a very powerful tool for a rough classification of Zygomycetes, but tends to be more precise in combination with phenotypic criteria. Thus, a single method of identification should always be supplemented with an additional support by different unlinked nucleotide sequence barcode markers in combination with morphological and physiological markers. Nevertheless, an advantage of ITS over others is that the primers are universally applicable and the sequences are usually diverse enough to distinguish between taxa down to the species level. A major drawback of the ITS lies in its repetitive nature and in the resulting escape of single copies from concerted evolution leading to different ITS sequence types in Zygomycetes (Schwarz et al. 2006). However, a critical vision of all paralogs of the ITS increases the quantity and the quality of the discriminating signal for zygomycete identification (Alastruey-Izquierdo et al. 2010).

In summary, apart from the choice of the right molecular barcode marker, the most serious problems in the molecular identification are still caused by a lack in the availability of suitable reference sequences (Hoffmann et al. 2009a) and their annotation in the public data bases of the International Nucleotide Sequence Database Collaboration (Nilsson et al. 2006). If sequence material is thought to be the primary information source for identification of isolates as intended in the various international barcode projects, an all-encompassing database of perfectly described, annotated voucher specimens is indispensable. Such an effort for an organised molecular identification of fungi was initiated by the creation of Mycobank at [www.mycobank.org](http://www.mycobank.org), an initiative of the Centraalbureau voor Schimmeltcultures Utrecht in the Netherlands (Crous et al. 2004). Mycobank provides onward links to DNA databases and nomenclatural novelties accessible in Mycobank, IndexFungorum, GBIF, and other international biodiversity initiatives for the realisation of a species bank that eventually links all databases of life.

### ***11.3.2 Diversity and Morphological Identification of the Mucoralean Genera Rhizopus and Mucor***

Within the order Mucorales (Mucoromycotina) two prominent genera exist, namely *Rhizopus* and *Mucor*. Whereas *Rhizopus* comprises closely related taxa (BS 100% in Fig. 11.4; Voigt et al. 1999; Voigt and Wöstemeyer 2001), the genus *Mucor* forms a highly polyphyletic group (Fig. 11.4; O'Donnell et al. 2001; Hoffmann et al. 2009a; Voigt et al. 2009). Both genera harbour species of ubiquitous soil fungi mainly living as saprobes. But under certain conditions some species could be responsible not only for agricultural and food spoilage but also for mucormycoses in humans and animals (Michailides and Spotts 1990; Ogawa et al. 1992; Ribes et al. 2000; Voigt et al. 1999).

The genus *Rhizopus* EHRENBERG with its type *R. stolonifer* is characterised by apophysate sporangia, stolons, and rhizoids. The sporangiophores arise mostly opposite the rhizoids (Fig. 11.2b3; Ehrenberg 1820; Schipper 1984; Schipper and Stalpers 1984). Traditional classification was mainly based on morphology (Zycha et al. 1969). In a revision, the genus was divided into three groups: the *R. arrhizus* (formerly *R. oryzae*) group, the *R. microsporus* group, and the *R. stolonifer* group (Schipper 1984; Schipper and Stalpers (1984). *R. arrhizus* represents a single species group; whereas the group of *R. microsporus* harbours its varieties, *R. m. var. microsporus*, *R. m. var. rhizopodiformis*, *R. m. var. oligosporus*, *R. m. var. chinensis*, and also *R. homothallicus*. The *R. stolonifer* group contained initially two species, *R. stolonifer* and *R. sexualis* comprising the varieties *R. s. var. stolonifer*, *R. s. var. lyococcus*, and *R. s. var. sexualis* and *R. s. var. americanus*, respectively (Schipper and Stalpers 1984). But later the varieties were elevated at the rank of species, e.g. *R. americanus* (Zheng et al. 2000) and *R. lyococcus* (Liou et al. 2007). On the basis of 28S rDNA (LSU, D1/D2 region), the members

of the *R. lyococcus* group can be clearly distinguished from the *R. stolonifer* group. This is concordant with the appearance of recurved sporangiophores exclusively found in the *R. lyococcus* group (Liou et al. 2007). In a monograph on the genus *Rhizopus* morphological traits, growth temperature, mating behaviour, and molecular systematics were considered as the main descriptive characters (Zheng et al. 2007). The authors accepted ten species and seven varieties, but no groups.

The Dictionary of the Fungi (Kirk et al. 2008) and the database of IndexFungorum ([www.indexfungorum.org](http://www.indexfungorum.org); as of 31th August 2009) recognise nine to ten species, respectively and eight varieties in the genus *Rhizopus*. Out of 155 entries in IndexFungorum, six entries were re-classified in four other genera, twelve entries were synonymous for *R. stolonifer*, and more than 70 entries were synonyms for *R. arrhizus* var. *arrhizus*. From the latter species, the clinical isolate RA99-880 (FGSC9543; NRRL43880) was sequenced and published by the Broad Institute of the Harvard University and the Massachusetts Institute of Technology (MIT). This species was chosen as one important representative agent of mucormycoses in order to gain knowledge on genes and their impact on pathobiology ([www.broad.mit.edu](http://www.broad.mit.edu)).

*R. arrhizus* differs from *R. stolonifer* by smaller sized and darker coloured sporangia, by the ornamentation of the zygospores, and by its high thermotolerance allowing colonisation of warm-blooded animals including humans (Schipper 1984).

Within the present study, several isolates from fruits collected in Saudi Arabia could be identified as members of the groups *R. stolonifer* and *R. arrhizus*. Identification was performed on the basis of micromorphology and DNA polymorphisms generated by nucleotide sequences and DNA fingerprints (Figs. 11.5 and 11.6).

On the other hand, the genus *Mucor* FRESENIUS with its type *M. mucedo* is characterised by the formation of non-apophysate sporangia (Fig. 11.2a) and the lack of stolons and rhizoids (Fresenius 1850; Schipper 1975).

As the genus *Mucor* is highly polyphyletic (O'Donnell et al. 2001; Voigt and Wöstemeyer 2001), the number of accepted species varies between 50 and 75 (Kirk et al. 2008; [www.indexfungorum.org](http://www.indexfungorum.org); as of 31th August 2009). Out of currently 700 entries in IndexFungorum, 116 entries were re-classified in forty other genera and fifteen were synonyms for the type species *M. mucedo*. The genome of *M. circinelloides* f. *lusitanicus* CBS 277.49 was sequenced by the Joint Genome Institute ([www.jgi.doe.gov](http://www.jgi.doe.gov)). *M. circinelloides* is currently divided into four formae with a total of 25 synonyms. The formae *circinelloides*, *lusitanicus*, *janssenii*, and *griseo-cyanus* differ mainly in their colony colour, sporangiospores, and appearance of the columellae (Schipper 1976). Differentiation between these formae still remains largely on morphological traits. Nucleotide sequence comparisons of the different formae are reported Sect. 11.3.5 of this chapter.

*M. circinelloides* is not closely related to any other species of *Mucor*. Its closest relatives are *M. mucedo* and *M. racemosus* as well as the facultative parasites *Parasitella* and *Chaetocladium* (100% BS, Fig. 11.4).



### **11.3.3 Phylogenetic Relevance of Morphological Markers**

While the common morphological characteristics of both genera, *Rhizopus* and *Mucor*, turned out to be very similar, only those of *Rhizopus* bear phylogenetic relevance, which allows a secure assignment to the genus. The combination of the criteria “stolons and rhizoids, apophysate sporangia, sporangiophores arising opposite the rhizoids” define a well-supported distinct evolutionary group, whereas the appearance of “non-apophysate sporangia and the lack of stolons and rhizoids” is not enough to describe the genus *Mucor*, because it matches also with the main characteristics of many other genera polyphyletic in *Mucor* (Fig. 11.4). As outlined in Sect. 11.3.1. the construction of an online platform linking all databases harbouring nucleotide sequences, as well as distinctive morphological and growth physiological criteria of the type strains from the core Mucoraceae, will help to revise the genus delimitations towards a natural system reflected in a monophyletic concept of the taxa.

### **11.3.4 Fine Scale Identification of *Rhizopus* Isolates Based on Combined Morphological and Molecular Characters**

Although various species of *Rhizopus* are morphologically very similar, there are some phylogenetic applicable characters allowing affiliations to different species complexes and species. Especially the complexity of rhizoids, length of sporangiophores, size of sporangia, appearance of zygospores, temperature range for growth, and preferred substrates differentiate between the three species complexes (as outlined in detail by Schipper and Stalpers 1984).

Thus, the species of *Rhizopus* isolated within this study were unequivocally identified by the application of the morphological traits mentioned before. The species designations were successfully supported by analyses of DNA sequence (Tables 11.3–11.4).

### **11.3.5 Synergistic Application of DNA-Polymorphism and DNA-Sequence Generating Tools**

Based on RAPD analyses, the isolates of *R. arrhizus* differ largely from those of *R. stolonifer* (Fig. 11.6). Two isolates of *R. arrhizus* from soil (samples 9 and 10) were identical in their banding patterns but differed largely from isolate 5, which was collected from a date fruit (Fig. 11.6). Nevertheless, the analysis of the ITS1 and 2 revealed no differences between the isolates from soil and date (Fig. 11.5, Table 11.7). In a sequence identity matrix, these isolates of *R. arrhizus* show highest similarities (97–98%) to the type of *R. arrhizus* CBS112.07 and to the

strain RA99-880 used in the genome project (Table 11.7). *R. arrhizus* is the sister group to *R. microsporus* complex with the species *R. microsporus*, *R. caespitosus*, and *R. homothallicus*. *R. schipperae* appears basal to *R. arrhizus* / *R. microsporus* supported by 99% PP (Fig. 11.5). According to sequence similarities and the original description, *R. schipperae* belongs clearly to the *R. microsporus* complex (Table 11.7; Weitzman et al. 1996). Sequence similarities within the *R. microsporus* complex range between 73–77% (except *R. schipperae* with ca. 60%) and are around 62–71% to the group of *R. arrhizus* (Table 11.7). The *R. microsporus* group and the *R. arrhizus* group are together the sister group to the *R. stolonifer* group including *R. sexualis* (100% PP, Fig. 11.5; Schipper 1984; Schipper and Stalpers 1984). RAPD analyses of different isolates from Saudi Arabian fruits show clearly two distinctive groups, each with more or less similar banding patterns, but on an average, the isolates collected from apricots show fewer bands than isolates collected from grapes (Fig. 11.6). ITS-sequence similarities within the species *R. stolonifer* are 84% between isolates from apricots and grapes, 84% between the apricot isolate and strain CBS150.83, and 99% between the grape isolate and CBS150.83 (Table 11.7). All isolates show similarities of 60–67% to *R. sexualis*. The differences between *R. sexualis* and *R. stolonifer* are similarly compared to those of *R. microsporus* versus *R. arrhizus*, thus indicating well-described and supported taxonomic group affiliations. Species of the genus *Rhizopus* seem to develop a certain host-specificity (Fig. 11.6). This is not the case in *M. circinelloides* (Fig. 11.7).

Although there are obvious correlations between the analyses of ITS sequences and RAPDs for *Rhizopus* isolates, there is no further correlation between these two analyses of the different isolates of *Mucor circinelloides*. On the basis of the ITS sequences, the isolates 6, 7, 10, 12, 14, and 15 are identical (data not shown, 100%) with closest similarity to isolate 3 (98%, Table 11.8). But an unequivocal assignment to different formae could not be achieved. Although the two formae isolated from Saudi Arabia were differentiated on the basis of the morphological criteria as *M. circinelloides* f. *circinelloides* and *M. circinelloides* f. *griseo-cyanus*, there is no reference sequence available from the latter forma. Both formae could be separated by their different size of the sporangiospores and the shape of their columellae.

On the basis of ITS sequence overall similarities, only the forma *lusitanicus* is clearly distinguishable from both other formae with 4–9% sequence dissimilarities (Table 11.8). But the sequence of the neotype from *M. circinelloides* f. *circinelloides* CBS195.68 shows 98–99% sequence identity to *M. circinelloides* f. *griseo-cyanus* FSU6257, FSU6259, and FSU9637. This similarity is higher than that of 97% with the isolate FSU6251, which was identified as *M. circinelloides* f. *circinelloides* (Table 11.8). Isolates of *M. circinelloides* f. *griseo-cyanus* show sequence dissimilarities between themselves ranging from 1–6% and sequence dissimilarities from 1–8% to the isolates of *M. circinelloides* f. *circinelloides*. This high deviations in sequence similarities is below forma-level and does therefore not facilitate a sufficient differentiation between the two formae. But evaluating the sequence alignment, few nucleotide positions occur that may help to tell the formae apart (Fig. 11.8). Within the 550 basepair long ITS1-5.8S rDNA-ITS2 alignment, 15



as a substitute for an adenosine. At position 367 is an inserted thymidine and at position 382 a thymidine instead of a cytosine. Such specific nucleotide positions within aligned sequences serve as markers, which differentiate between species and subspecies when the whole sequence is not able to separate properly. Unlike *Rhizopus* and its fruit-dependent ITS variances, there are no such differences within the isolates and formae of *M. circinelloides* and their substrate collection.

Primer V6 shows no correlations between the origin of the isolate, e.g., with similar patterns for isolates 3 & 4 (from date) and 9 & 10 (from plum) (Fig. 11.7). Dissimilar patterns were also observed, e.g., the isolated pairs 7 & 8, 9 & 10, and 5 & 6, which all originate from plums (Fig. 11.7). Even there are more bands for the RAPD primer M13; there is also no correlation between origin and below-species level designation possible. But primer M13 could differentiate between e.g. 3 & 4 (date) and 9 & 10 (plum). The similar RAPD patterns for both primers between the pairs 3 & 4, 5 & 6, 9 & 10, 11 & 12, and 13 & 14 suggest that these species originate from a common clonal line and do presumably belong to *M. circinelloides* f. *griseo-cyanus* (Fig. 11.7). Thus, the species of *Rhizopus* are more host-specific than the isolates of *Mucor circinelloides*. Consequently, it can be argued that host specificity may take part at the species level rather than at the below-species level. More detailed information about the molecular identification of food- and fruitborne *Rhizopus* and *Mucor* strains are published elsewhere (Gherbawy and Hussien 2009).

### **11.3.6 Evaluation of Potential Barcoding Methods and the Impact of Extended Species Recognition**

Species of the investigated genera *Rhizopus* and *Mucor* harbour important agents of post harvest diseases and mucormycoses. A fast, accurate, cost-saving method to unequivocally assign an unknown isolate to a species would be of great interest. Although there are only few species, which cause mucormycoses (mainly *Rhizopus arrhizus* and *Mucor circinelloides*), there exist different sensitivities against anti-fungals (Ribes et al. 2000; Dannaoui et al. 2003; Alastruey-Izquierdo et al. 2009). Thus, profound studies on the geographic occurrence and diversity, genetic variability, and epidemiological significance of important fungal species are required. DNA barcodes like ITS, IGS, 28S rDNA sequences and RAPDs already proved to be useful markers to differentiate species and varieties for well-supported and well-studied fungal groups (this study; Liou et al. 2007; Liu et al. 2008; Hoffmann et al. 2009a). However, molecular barcoding based on short standardised DNA regions is neither a tool for phylogenetic reconstructions nor for taxonomical purposes. Molecular barcoding solely provides means for the linkage of a sample specimen to already existing taxonomical, systematic, and phylogenetic information. But a non-negligible advantage of molecular barcoding is its ability for aiding ecologists to gain insights into species diversity and identity of environmental samples, a goal in well-timed pest control (Valentini et al. 2009).

### 11.3.7 *The Pressing Need for Reliable Species Identification*

The present systematics of Zygomycetes suggests a more generalised lifestyle than that in derived fungi. Host specificity is manifested already on species level, whereas many derived fungi show broad host ranges on species level and small host ranges on sub-species levels. For instance, the ascomycetous genus *Fusarium* is well-studied because of its agricultural importance as causative agent of the head blight of wheat as well as crown and stem rots causing immense yield losses and mycotoxin envenomations in humans and animals after the consumption of infected grains. Epidemiological studies revealed a very broad host range with different *formae speciales* of *Fusarium* spp. based on their specificities to certain host plants (Michielse and Rep 2009).

Probably because of the underestimation of the plant and animal damaging potential of zygomycetous fungi, the number of currently described species is most likely undervalued. With a denser monitoring of their diversity and their epidemiology the identification of a broader spectrum of species also defined by substrate specificity can be predicted. In recent years several studies were published, reducing existing species to the status of “synonyms” resulting in the aforementioned high number of synonyms (e.g. Hoffmann et al. 2007, 2009a, b; Alastruey-Izquierdo et al. 2010; Zheng et al. 2007). For example, more than 70 synonyms were described for *R. arrhizus* (Zheng et al. 2007; IndexFungorum). Few physiological and chemotaxonomical characters not commonly used for the identification of Zygomycetes, such as differences in the utilisation of carbon and nitrogen sources, the formation of specific compounds (cell wall sugars, fatty acids etc.), or the quantity of sporulation, were not accepted by the scientific community leading to a considerable reduction of the number of species by Zycha (1935) and others. On the other hand, the ability to produce organic acids was recently considered in species recognition, separating the *R. arrhizus* group once again into *R. arrhizus* var. *arrhizus* and *R. arrhizus* var. *delemar* (Abe et al. 2003; Zheng et al. 2007). Substrate specificities combined with established and accepted morphological and phylogenetic approaches could be a useful tool to differentiate and restore already described species to accomplish a natural system of species, which does also consider evolutionary distances in order to gain an increase in the objectivity of setting species limitations. The resulting refinement in the definition of the phylogenetic species concept (Taylor et al. 2000) allows a more reliable and precise identification of a fungal specimen and is essential for comparative verifications of industrial, environmental, or pathogenic strains (Ogawa et al. 1992; Hachmeister and Fung 1993; Voigt et al. 1999; Hageskal et al. 2006).

## 11.4 Conclusions

For the identification and the classification of specimens, a conscientious plan of the approaches with careful judgement of the obtained data is mandatory and will lead to sustainable results. The combination of different scientific expertise will solve the puzzle of diverse characters.

With the concatenation of traditional with molecular approaches and its advantage of universal applicability, the identification of fungi will rapidly develop and achieve a more precise delimitation of taxonomical groups than single criteria.

But what could be the contribution of the DNA barcodes? The database of the Consortium for the Barcode of Life (<http://www.barcoding.si.edu>) is also supposed to help non-taxonomists in the assignment of an unknown specimen to a well-described voucher specimen based on short barcode sequences, which are easy to obtain. These barcodes are thought of for the protection of the Earth's biodiversity which is preceded by the elucidation of the Earth's biodiversity. Molecular barcodes are essential where no other opportunities for identification are possible, e.g. missing discriminating data or under axenic conditions not cultivable specimens. The protection of endangered life forms, and the control of pests and their vectors are only few of the objectives examples supporting barcode research (CBOL, <http://barcoding.si.edu>). But we should not forget that DNA barcodes were not designed for the identification of new species. DNA barcodes are often not sufficient enough for the exploration of new species and will probably fail (Aliabadian et al. 2009). Nevertheless, with the ability to identify fungal species on the basis of sequence information, a trend can be detected in disregarding characters other than DNA sequences for the identification and the description of species. Trusting in a single or few non-descriptive characters is a highly alarming trend. For instance, single BLAST searches could be using inaccurate sequence data (Balajee et al. 2009; Bridge et al. 2003). Although there are constant changes in the terminology of fungal morphology and taxonomy, descriptive traditional characters are essential and must not be neglected.

Furthermore, molecular, biochemical, ecological, and physiological parameters can efficiently reveal morphologically identical species, cryptic species. The exploration of cryptic species is accelerating in recent years, for example in the dikaryomycotean genera *Trichoderma* (Gams and Bissett 1998), *Fusarium* (Baayen et al. 2000; O'Donnell 2000; O'Donnell et al. 2000), *Armillaria* (Pegler 2000), *Aspergillus* (Geiser et al. 1998; Pringle et al. 2005), or *Penicillium*.

With the identification and the development of characters which are independent from external influences, and therefore, less error-prone than other criteria, the DNA markers are often preferred over morphological data. Because of the occasionally large intra-specific variability, the lack of sufficient distinctive characters, or the dependence upon physiological parameters (Schipper 1973; Zycha et al. 1969), informative phenotypic data are often hard to obtain and to reproduce. But without reliable morphological data, an assignment of molecular data to a specific reference fungal specimen is not possible (Hoffmann et al. 2009a). Without reliable reference strains and reference sequences a molecular identification is impossible. With the ongoing trend to identifying fungal specimens using DNA barcodes, a broad-ranged and well-defined taxonomic database is crucial (Meyer and Paulay 2005) because barcodes are only useful to assign unidentified specimens to already known and described species. The same way, DNA markers can distinguish morphological cryptic species; molecular biologically cryptic species can be differentiated



by morphology. Therefore, the combination of phenotypic and molecular data is highly recommended.

A gap located between the proposed total number of fungal species of at least 1.5 million (Hawksworth 1991; Kirk et al. 2001; Hawksworth 2001) and the number described so far, which ranges between 72,000 and 120,000 (Hawksworth and Rossman 1997; Hawksworth 2001), implies a large number of still undiscovered and undescribed species. Once the problems of DNA barcoding, resulting from insufficient sampling of voucher specimens, insufficient barcode markers (e.g. paralogues), or bad taxonomy of voucher specimens because of misidentification or because poly- or paraphyletic species are avoided, the large scaled molecular identification of fungi will be a powerful and rapid procedure for the assessment of the fungal organisms in the biosphere (Hebert et al. 2004a; Wiemers and Fiedler 2007; Funk and Omland 2003; Moritz and Cicero 2004).

**Authors' Contributions and Competing Interests** The authors declare that they have no competing interests. CK is a graduate student and performed identification by traditional analyses as well as sequencing of all fungi except the species related to the *Rhizopus* sp. – *Mucor circinelloides* part. YG and NG collected all Saudi Arabian fungal isolates and did all experiments related to the *Rhizopus* sp. – *Mucor circinelloides* part, including identification, sequencing, and RAPD analyses. YG provided inspiring ideas and contributed to the discussion of the results. KH performed the phylogenetic analyses, coordinated the work, and wrote the manuscript.

**Acknowledgements** The authors wish to thank Martin Kirchmair (University of Innsbruck, Austria) who kindly provided the zygomycetes strains FSU6510-6527 and Roman Schwarz (Medizinisches Versorgungszentrum, Mönchengladbach, Germany) who kindly provided the zygomycetes strains FSU6529, FSU6530, FSU6250-6252, FSU6274.

## References

- Abe A, Sone T, Sujaya I-N, Saito K, Oda Y, Asano K, Tomita F (2003) rDNA ITS sequences of *Rhizopus oryzae*: its application to classification and identification of lactic acid producers. *Biosci Biotechnol Biochem* 67:1725–1731
- Alastruey-Izquierdo A, Castelli MV, Cuesta I, Monzon A, Cuenca-Estrella M, Rodriguez-Tudela JL (2009) Activity of posaconazole and other antifungal agents against Mucorales strains identified by sequencing of internal transcribed spacers. *Antimicrob Agents Chemother* 53:1686–1689
- Alastruey-Izquierdo A, Hoffmann K, Hoog de GS, Rodriguez-Tudela JL, Voigt K, Bibashi E, Walther G (2010) Species recognition and clinical relevance of the zygomycetous genus *Lichtheimia* (syn. *Mycocladius*, *Absidia* pp). in revision
- Aliabadian M, Kaboli M, Nijman V, Vences M (2009) Molecular identification of birds: performance of distance-based DNA barcoding in three genes to delimit parapatric species. *PLoS ONE* 4:e4119
- Almyroudīs N, Sutton D, Fothergill A, Rinaldi M, Kusne S (2007) In vitro susceptibilities of 217 clinical isolates of Zygomycetes to conventional and new antifungal agents. *Antimicrob Agents Chemother* 51:2587–2590

- Alvarez E, Sutton DA, Cano J, Fothergill AW, Stchigel A, Rinaldi MG, Guarro J (2009) Spectrum of zygomycete species identified from clinically significant specimens in the United States. *J Clin Microbiol* doi:10.1128/JCM00036-09
- Arnot DE, Roper C, Bayoumi RA (1993) Digital codes from hypervariable tandemly repeated DNA sequences in the *Plasmodium falciparum* circumsporozoite gene can genetically barcode isolates. *Mol Biochem Parasitol* 61:15–24
- Baayen RP, O'Donnell K, Bonants PJM, Cigelnik E, Kroon LPNM, Roebroek EJA, Waalwijk C (2000) Gene genealogies and AFLP analyses in the *Fusarium oxysporum* complex identify monophyletic and nonmonophyletic formae speciales causing wilt and rot disease. *Phytopathology* 90:891–900
- Bal AM (2006) Importance of identification of zygomycetes in the era of newer antifungal agents. *Transpl Infect Dis* 8:122–123
- Balajee SA, Houbraken J, Verweij PE, Hong S-B, Yaguchi T, Varga J, Samson RA (2007) *Aspergillus* species identification in the clinical setting. *Stud Mycol* 59:39–46
- Balajee SA, Borman AM, Brandt ME, Cano J, Cuenca-Estrella M, Dannaoui E, Guarro J, Haase G, Kibbler CC, Meyer W, O'Donnell K, Petti CA, Rodriguez-Tudela JL, Sutton D, Velegriaki A, Wickes BL (2009) Sequence-based identification of *Aspergillus*, *Fusarium* and Mucorales in the clinical mycology laboratory: where are we and where should we go from here? *J Clin Microbiol* 47:877–884
- Benjamin RK (1979) Zygomycetes and their spores. In: Kendrick B (ed) *The whole fungus the sexual-asexual synthesis*. National Museum of Natural Science. National Museums of Canada and The Kananaskis Foundation Ottawa, Canada, pp 573–616
- Berbee LM, Taylor JW (2001) Fungal molecular evolution: gene trees and geologic time In: McLaughlin DJ, McLaughlin EG, Lemke PA (eds) *The Mycota*, vol 7B. Systematics and evolution, Springer, Berlin, Germany, pp 229–245
- Bradley RD, Baker RJ (2001) A test of the genetic species concept: cytochrome b sequences and mammals. *J Mammal* 82:960–973
- Bridge PD, Roberts PJ, Spooner BM, Panchal G (2003) On the unreliability of published DNA sequences. *New Phytol* 160:43–48
- Chase MW, Salamin N, Wilkinson M, Dunwell JM, Kesanakurthi RP, Haidar N, Svolainen V (2005) Land plants and DNA barcodes: short-term and long-term goals. *Philos Trans R Soc London B* 360:1889–1895
- Crous PW, Gams W, Stalpers JA, Robert V, Stegehuis G (2004) Mycobank: an online initiative to launch mycology into the 21<sup>st</sup> century. *Stud Mycol* 50:19–22
- Cuenca-Estrella M, Gomez-Lopez A, Mellado E, Buitrago MJ, Monzon A, Rodriguez-Tudela JL (2006) Head-to-head comparison of the activities of currently available antifungal agents against 3, 378 Spanish clinical isolates of yeasts and filamentous fungi. *Antimicrob Agents Chemother* 50:917–921
- Dannaoui E, Meletiadis J, Mouton JW, Meis JF, Verweij PE, The Eurofung Network (2003) In vitro susceptibilities of Zygomycetes to conventional and new antifungals. *J Antimicrob Chemother* 51:45–52
- de Hoog GS, Guarro J, Gené J, Figueras MJ (2000) *Atlas of clinical fungi*. 2nd edn. Centraalbureau voor Schimmelcultures/University Rovira i Virgili, Utrecht, The Netherlands, Reus, Spain
- Diwakar A, Dewan RK, Chowdhary A, Randhawa HS, Khanna G, Gaur SN (2007) Zygomycosis – a case report and overview of the disease in India. *Mycoses* 50:247–254
- Druzhinina IS, Kopchinskiy AG, Komon M, Bissett J, Szakacs G, Kubicek CP (2005) An oligonucleotide barcode for species identification in *Trichoderma* and *Hypocrea*. *Fungal Genet Biol* 42:813–828
- Ehrenberg CG (1820) *De mycetogenesi* as Acad C.L.C.N.C Praesidem Epistola Nova Acta Academiae Caesareae Leopoldino-Carolinae Germanicae. *Naturae Curiosorum* 10:159–222
- Einax E, Voigt K (2003) Oligonucleotide primers for the universal amplification of beta-tubulin genes facilitate phylogenetic analyses in the regnum Fungi. *Org Divers Evol* 3:185–194
- Ellis JJ, Hesselstine CW (1965) The genus *Absidia*: globose-spored species. *Mycologia* 57:222–235



- Ellis JJ, Hesseltine CW (1966) Species of *Absidia* with ovoid sporangiospores II. *Sabouraudia* 5:59–77
- Felsenstein J (1985) Confidence limits of phylogenies: an approach using the bootstrap. *Evolution* 39:783–791
- Fenchel T, Finlay BJ (2006) The diversity of microbes: resurgence of the phenotype. *Philos Trans R Soc B* 361:1965–1973
- Fresenius G (1850) *Mucor mucedo*. *Beiträge zur Mykologie* 1:7
- Funk DJ, Omland KE (2003) Species-level paralogy and polyphyly: frequency, causes, and consequences, with insights from animal mitochondrial DNA. *Annu Rev Ecol Syst* 34:397–423
- Gams W, Bissett J (1998) Morphology and identification of *Trichoderma*. In: Kubicek CP, Harman GE (eds) *Trichoderma and Gliocladium*. Basic Biology, Taxonomy and Genetics. Taylor and Francis, London, UK, pp 3–34
- Geiser DM, Pitt JI, Taylor JW (1998) Cryptic speciation and recombination in the aflatoxin-producing fungus *Aspergillus flavus*. *Proc Natl Acad Sci USA* 95:388–393
- Geiser DM, Jimenez-Gasco MD, Kang SC, Makalowska I, Veeraraghavan N, Ward TJ, Zhang N, Kuldau GA, O'Donnell K (2004) FUSARIUM-ID v 10: a DNA sequence database for identifying *Fusarium*. *Eur J Plant Pathol* 110:473–479
- Geiser DM, Klich MA, Frisvad JC, Peterson SW, Varga J, Samson RA (2007) The current status of species recognition and identification in *Aspergillus*. *Stud Mycol* 59:1–10
- Gherbawy Y, Hussien N (2009) Molecular characterization of *Mucor circinelloides* and *Rhizopus stolonifer* strains isolated from some Saudi fruits. *Foodborne Pathog Dis* 7(2) doi: 10.1089/fpd.2009.0359
- Glass NL, Donaldson GC (1995) Development of primer sets designed for use with the PCR to amplify conserved genes from filamentous ascomycetes. *Appl Environ Microbiol* 61:1323–1330
- Greenberg RN, Scott LJ, Vaughn HH, Ribes JA (2004) Zygomycosis (mucormycosis): emerging clinical importance and new treatments. *Curr Opin Infect Dis* 17:517–525
- Hachmeister KA, Fung DY (1993) Tempeh: a mold-modified indigenous fermented food made from soybeans and/or cereal grains. *Crit Rev Microbiol* 19:137–188
- Hageskal G, Knutsen AK, Gaustad P, deHoog GS, Skaar I (2006) Diversity and significance of mold species in Norwegian drinking water. *Appl Environ Microbiol* 72:7586–7593
- Hawksworth DL (1991) The fungal dimension of biodiversity: magnitude, significance, and conservation. *Mycol Res* 95:641–655
- Hawksworth DL (2001) The magnitude of fungal diversity: the 15 million species estimate revisited. *Mycol Res* 105:1422–1432
- Hawksworth DL, Rossman AY (1997) Where are all the undescribed fungi? *Phytopathology* 87:888–891
- Hebert PDN, Cywinska A, Ball SL, deWaard JR (2003) Biological identification through DNA barcodes. *Proc R Soc Lond B* 270:313–322
- Hebert PDN, Stoeckle MA, Zemplak TS, Francis CM (2004a) Identification of birds through DNA barcodes. *PLoS Biol* 2:1657–1663
- Hebert PDN, Penton EH, Burns JM, Janzen DH, Hallwachs W (2004b) Ten species in one, DNA barcoding reveals cryptic species in the neotropical skipper butterfly *Astraptes fulgerator*. *Proc Natl Acad Sci USA* 101:14812–14817
- Helbig AJ, Seibold I (1999) Molecular phylogeny of Palearctic–African Acrocephalus and Hippolais warblers (Aves: Sylviidae). *Mol Phylogenet Evol* 11:246–260
- Hesseltine CW, Ellis JJ (1961) Notes on Mucorales, especially *Absidia*. *Mycologia* 53:406–426
- Hesseltine CW, Ellis JJ (1964) The genus *Absidia*: *Gongronella* and cylindrical-spored species of *Absidia*. *Mycologia* 56:568–601
- Hesseltine CW, Ellis JJ (1966) Species of *Absidia* with ovoid sporangiospores I. *Mycologia* 58:761–785
- Hibbett DS, Binder M, Bischoff JF, Blackwell M, Cannon PF, Eriksson OE, Huhndorf S, James T, Kirk PM, Lücking R, Lumbs HT, Lutzoni F, Matheny PB, McLaughlin DJ, Powell MJ, Redhead S, Schoch CL, Spatafora JW, Stalpers JA, Vilgalys R, Aime MC, Aptroot A,

- Bauer R, Begerow D, Benny GL, Castlebury LA, Crous PW, Dai YC, Gams W, Geiser DM, Griffith GW, Gueidan C, Hawksworth DL, Hestmark G, Hosaka K, Humber RA, Hyde KD, Ironside JE, Køljalg U, Kurtzman CP, Larsson KH, Lichtwardt R, Longcore J, Miadlikowska J, Miller A, Moncalvo JM, Mozley-Standridge S, Oberwinkler F, Parmasto E, Reeb V, Rogers JD, Roux C, Ryvar den L, Sampaio JP, Schüssler A, Sugiyama J, Thorn RG, Tibell L, Untereiner WA, Walker C, Wang Z, Weir A, Weiss M, White MM, Winka K, Yao YJ, Zhang N (2007) A higher-level phylogenetic classification of the Fungi. *Mycol Res* 111:509–547
- Higgins DG, Sharp PM (1988) CLUSTAL: a package for performing multiple sequence alignment on a microcomputer. *Gene* 73:237–244
- Higgins DG, Sharp PM (1989) Fast and sensitive multiple sequence alignments on a microcomputer. *Comp Appl Biosciences* 5:151–153
- Hoffmann K, Discher S, Voigt K (2007) Revision of the genus *Absidia* (Mucorales, Zygomycetes): based on physiological, phylogenetic and morphological characters: thermotolerant *Absidia* spp form a coherent group, the Mycocladiaceae fam nov. *Mycol Res* 111:1169–1183
- Hoffmann K, Telle S, Walther G, Eckart M, Kirchmair M, Prillinger H, Prazenica A, Newcombe G, Dölz F, Papp T, Vágvölgyi C, deHoog S, Olsson L, Voigt K (2009a) Diversity, genotypic identification, ultrastructural and phylogenetic characterization of zygomycetes from different ecological habitats and climatic regions: limitations and utility of nuclear ribosomal DNA barcode markers. In: Gherbawy Y, Mach RL, Rai M (eds) Current advances in molecular mycology. Nova Science Publishers, Inc, New York, pp 263–312
- Hoffmann K, Walther G, Voigt K (2009b) *Mycocladus* vs *Lichtheimia*: a correction (Lichtheimiaceae fam. nov., Mucorales, Mucoromycotina). *Mycol Res* 113:277–278
- Hong SB, Go SJ, Shin HD, Frisvad JC, Samson RA (2005) Polyphasic taxonomy of *Aspergillus fumigatus* and related species. *Mycologia* 97:1316–1329
- Hong SB, Cho HS, Shin HD, Frisvad JC, Samson RA (2006) Novel *Neosartorya* species isolated from soil in Korea. *Int J Syst Evol Microbiol* 56:477–486
- Huelsenbeck JP, Ronquist F (2001) MRBAYES: bayesian inference of phylogeny. *Bioinformatics* 17:754–755
- Iwen PC, Freifeld AG, Sigler L, Tarantolo SR (2005) Molecular identification of *Rhizomucor pusillus* as a cause of sinus-orbital zygomycosis in a patient with acute myelogenous leukaemia. *J Clin Microbiol* 43:5819–5821
- Iwen PC, Sigler L, Noel RK, Freifeld AG (2007) *Mucor circinelloides* was identified by molecular methods as a cause of primary cutaneous zygomycosis. *J Clin Microbiol* 45:636–640
- James TY, Kauff F, Schoch CL, Matheny PB, Hofstetter V, Cox C, Celio G, Gueidan C, Fraker E, Miadlikowska J, Lumbsch HT, Rauhut A, Reeb V, Arnold EA, Amtoft A, Stajich JE, Hosaka K, Sung G-H, Johnson D, O'Rourke B, Crockett M, Binder M, Curtis JM, Slot JC, Wang Z, Wilson AW, Schüßler A, Longcore JE, O'Donnell K, Mozley-Standridge S, Porter D, Letcher PM, Powell MJ, Taylor JW, White MM, Griffith GW, Davies DR, Humber RA, Morton J, Sugiyama J, Rossman AY, Rogers JD, Pfister DH, Hewitt D, Hansen K, Hambleton S, Shoemaker RA, Kohlmeyer J, Volkmann-Kohlmeyer B, Spotts RA, Serdani M, Crous PW, Hughes KW, Matsuura K, Langer E, Langer G, Untereiner WA, Lücking R, Büdel B, Geiser DM, Aptroot A, Diederich P, Schmitt I, Schultz M, Yahr R, Hibbett DS, Lutzoni F, McLaughlin D, Spatafora J, Vilgalys R (2006) Reconstructing the early evolution of the fungi using a six-gene phylogeny. *Nature* 443:818–822
- James TY, Letcher PM, Longcore JE, Mozley-Standridge SE, Porter D, Powell MJ, Griffith GW, Vilgalys R (2007) A molecular phylogeny of the flagellated fungi (Chytridiomycota) and description of a new phylum (Blastocladiomycota). *Mycologia* 98:860–871
- Johnson NK, Cicero C (2004) New mitochondrial DNA data affirm the importance of Pleistocene speciation in North American birds. *Evolution* 58:1122–1130
- Kirk PM, Cannon PF, David JC, Stalpers JA (2001) *Ainsworth & Bisby's Dictionary of the fungi*, 9th edn. CABI Publishing, Wallingford, United Kingdom
- Kirk PM, Cannon PF, Minter DW, Stalpers JA (2008) *Dictionary of the fungi*, 10th edn. CABI Publishing, Wallingford, United Kingdom

- Kress WJ, Erickson DL (2007) A two-locus global DNA barcode for land plants: the coding *rbcL* gene complements the non-coding *trnHpsbA* spacer region. *PLoS ONE* 2:e508
- Kress WJ, Wurdack KJ, Zimmer EA, Weigt LA, Janzen DH (2005) Use of DNA barcodes to identify flowering plants. *Proc Natl Acad Sci USA* 102:8369–8374
- Lemer S, Aurelle D, Vigliola L, Durand JD, Borsa P (2007) Cytochrome b barcoding, molecular systematics and geographic differentiation in rabbitfishes (Siganidae). *C R Biol* 330:86–94
- Leslie JF, Summerell BA (2006) *Fusarium* laboratory manual, 1st edn. Ames, Iowa (ua), Blackwell Publishers, pp 1–388
- Liu X, Huang H, Zheng R (2008) Delimitation of *Rhizopus* varieties based on IGS rDNA. *Sydowia* 60:93–112
- Liou G, Chen S, Wei H, Lee F, Fu H, Yuan G, Stalpers JA (2007) Polyphasic approach to the taxonomy of the *Rhizopus stolonifer* group. *Mycol Res* 111:196–203
- Lopandic K, Prillinger H, Molnar O, Gimenez-Jurado G (1996) Molecular characterisation and genotypic identification of *Metschnikowia* species. *Syst Appl Microbiol* 19:393–402
- Metellus P, Laghmari M, Fuentes S, Eusebio A, Adetchessi T, Ranque S, Bouvier C, Dufour H, Grisoli F (2008) Successful treatment of a giant isolated cerebral mucormycotic (zygomycotic) abscess using endoscopic debridement: case report and therapeutic considerations. *Surg Neurol* 69:510–515
- Meyer CP, Paulay G (2005) DNA barcoding: error rates based on comprehensive sampling. *PLoS Biol* 3:2229–2238
- Michailides TJ, Spotts RA (1990) Postharvest diseases of pome and stone fruits caused by *Mucor piriformis* in the Pacific northwest and California. *Plant Dis* 74:537–543
- Michielse CB, Rep M (2009) Pathogen profile update: *Fusarium oxysporum*. *Mol Plant Pathol* 10:311–324
- Moritz C, Cicero C (2004) DNA barcoding: promise and pitfalls. *PLoS Biol* 2:1529–1531
- Newmaster SG, Fazekas AJ, Ragupathy S (2006) DNA barcoding in land plants: evaluation of *rbcL* in a multigene tiered approach. *Can J Bot* 84:335–341
- Nilsson RH, Ryberg M, Kristiansson E, Abarenkov K, Larsson K-H, Kõljalg U (2006) Taxonomic reliability of DNA sequences in public sequence databases: a fungal perspective. *PLoS ONE* 1:e59
- Nucci M, Marr KA (2005) Emerging fungal diseases. *Clin Infect Dis* 41:521–526
- O'Donnell K (2000) Molecular phylogeny of the *Nectria haematococca* – *Fusarium solani* species complex. *Mycologia* 92:919–938
- O'Donnell K, Cigelnik E (1997) Two divergent intragenomic rDNA ITS2 types within a monophyletic lineage of the fungus *Fusarium* are nonorthologous. *Mol Phyl Evol* 7:103–116
- O'Donnell K, Cigelnik E, Nirenberg HI (1998) Molecular systematics and phylogeography of the *Gibberella fujikuroi* species complex. *Mycologia* 90:465–493
- O'Donnell K, Gherbawy Y, Schweigkofler W, Adler A, Prillinger H (1999) Comparative phylogenetic analysis of *Fusarium oxysporum* and related species from maize using DNA sequence and RAPD data. *J Phytopathol* 147:445–452
- O'Donnell K, Kistler HC, Tacke BK, Casper HH (2000) Gene genealogies reveal global phylogeographic structure and reproductive isolation among lineages of *Fusarium graminearum*, the fungus causing wheat scab. *Proc Natl Acad Sci USA* 97:7905–7910
- O'Donnell K, Lutzoni FM, Ward TJ, Benny GL (2001) Evolutionary relationships among mucoralean fungi (Zygomycota): evidence for family polyphyly on a large scale. *Mycologia* 93:286–296
- Ogawa JM, Sonada RM, English H (1992) Postharvest diseases of tree fruit. In: Kumar J, Chaube HS, Singh US, Mukhopadhyay AN (eds) *Plant diseases on international importance*, vol III. Englewood Cliffs, Diseases of fruit crops Prentice Hall, pp 405–422
- Park MH, Sim CJ, Baek J, Min GS (2007) Identification of genes suitable for DNA barcoding of morphologically indistinguishable Korean halichondriidae sponges. *Mol Cells* 23:220–227
- Pegler DN (2000) Taxonomy, nomenclature and description of *Armillaria*. In: Fox RTV (ed) *Armillaria Root Rot: biology and control of honey fungus*. Intercept, Andover, pp 81–93

- Pringle A, Baker DM, Platt JL, Wares JP, Latge JP, Taylor JW (2005) Cryptic speciation in the cosmopolitan and clonal human pathogenic fungus *Aspergillus fumigatus*. *Evolution* 59:1886–1899
- Raper KB, Fennell DI (1965) The genus *Aspergillus*. Williams and Wilkins Company, Baltimore, pp 1–686
- Raper KB, Thom C (1949) Manual of the penicillia. Williams and Wilkins Company, Baltimore, pp 1–875
- Ribes JA, Vanover-Sams CL, Baker DJ (2000) Zygomycetes in human disease. *Clin Microbiol Rev* 13:236–301
- Roden MM, Theoklis TZ, Buchanan WL, Knudsen TA, Sarkisova TA, Schaufele RL, Sein M, Sein T, Chiou CC, Chu JH, Kontoyiannis DP, Walsh TJ (2005) Epidemiology and outcome of Zygomycosis: a review of 929 reported cases. *Clin Infect Dis* 41:634–653
- Rogers TR (2008) Treatment of zygomycosis: current and new options. *J Antimicrob Chemother* 61:35–40
- Rogers JS, Swofford DL (1998) A fast method for approximating maximum likelihood of phylogenetic trees from nucleotide sequences. *Syst Biol* 47:77–89
- Ronquist F, Huelsenbeck JP (2003) MRBAYES 3: bayesian phylogenetic inference under mixed models. *Bioinformatics* 19:1572–1574
- Samson RA, Frisvad JC (eds) (2004) *Penicillium* subgenus *Penicillium*: new taxonomic schemes, mycotoxins and other extrolites. *Stud Mycol* 49:1–251
- Samson RA, Seifert KA, Kuijpers AFA, Houbraken JAMP, Frisvad JC (2004) Phylogenetic analysis of *Penicillium* subgenus *Penicillium* using partial beta-tubulin sequences. *Stud Mycol* 49:175–200
- Saunders GW (2005) Applying DNA barcoding to red macroalgae: a preliminary appraisal holds promise for future applications. *Philos Trans R Soc Lond B* 360:1879–1888
- Schipper MAA (1973) A study on variability in *Mucor hiemalis* and related species. *Stud Mycol (Baarn)* 4:1–40
- Schipper MAA (1975) *Mucor mucedo*, *Mucor flavus* and related species. *Stud Mycol (Baarn)* 10:1–33
- Schipper MAA (1976) *Mucor circinelloides*, *Mucor racemosus* and related species. *Stud Mycol (Baarn)* 12:1–40
- Schipper MAA (1984) A revision of the genus *Rhizopus* I The *Rhizopus stolonifer*-group and *Rhizopus oryzae*. *Stud Mycol (Baarn)* 25:1–19
- Schipper MAA (1990) Notes on Mucorales – I Observations on *Absidia*. *Persoonia* 14:133–149
- Schipper MAA, Stalpers JA (1984) A revision of the genus *Rhizopus* II The *Rhizopus microsporus*-group. *Stud Mycol (Baarn)* 25:20–34
- Schüßler A, Schwarzott D, Walker C (2001) A new fungal phylum, the glomeromycota: phylogeny and evolution. *Mycol Res* 105:1413–1421
- Schwarz P, Bretagne S, Gantier J-C, García-Hermoso D, Lortholary O, Dromer F, Dannaoui E (2006) Molecular identification of Zygomycetes from culture and experimentally infected tissues. *J Clin Microbiol* 44:340–349
- Seifert KA, Samson RA, de Waard JR, Houbraken J, Lévesque CA, Moncalvo J-M, Louis-Seize G, Hebert PDN (2007) Prospects for fungus identification using *COI* DNA barcodes, with *Penicillium* as a test case. *PNAS* 104:3901–3906
- Singh J, Rimek D, Kappe R (2005) In vitro susceptibility of 15 strains of Zygomycetes to nine antifungal agents as determined by the NCCLS M38-A microdilution method. *Mycoses* 48:246–250
- Skouboe P, Boysen M, Pedersen LH, Frisvad JC, Rossen L (1996) Identification of penicillium species using the internal transcribed spacer (ITS) regions. In: Rossen L, Rubio V, Dawson MT, Frisvad JC (eds) Fungal identification techniques. European Commission, Brussels, Belgium, pp 160–164
- Skouboe P, Frisvad JC, Taylor JW, Lauritsen D, Boysen M, Rossen L (1999) Phylogenetic analysis of nucleotide sequences from the ITS region of terverticillate *Penicillium* species. *Mycol Res* 103:873–881

- Sugiyama J (1998) Relatedness, phylogeny, and evolution of the fungi. *Mycoscience* 39: 487–511
- Summerbell RC, Moore MK, Starink–Willemsse M, Van Iperen A (2007) ITS barcodes for *Trichophyton tonsurans* and *T. equinum*. *Med Mycol* 45:193–200
- Swofford DL (1998) PAUP\*: phylogenetic analysis using parsimony (\*and other methods) version 4. Sinauer Associates, Sunderland, MA
- Tavares ES, Baker AJ (2008) Single mitochondrial gene barcodes reliably identify sister-species in diverse clades of birds. *BMC Evol Biol* 8:81
- Taylor JW, Jacobson DJ, Kroken S, Kasuga T, Geiser DM, Hibbett DS, Fisher MC (2000) Phylogenetic species recognition and species concepts in fungi. *Fungal Genet Biol* 31:21–32
- Thompson JD, Gibson TJ, Plewniak F, Jeanmougin F, Higgins DG (1997) The Clustal X windows interface: flexible strategies for multiple sequence alignment aided by quality analysis tools. *Nucl Acids Res* 25:4876–4882
- Trifilio SM, Bennett CL, Yarnold PR, McKoy JM, Parada J, Mehta J, Chamilos G, Paella F, Kennedy L, Mullane K, Tallman MS, Evens A, Scheetz MH, Blum W, Kontoyiannis DP (2007) Breakthrough zygomycosis after voriconazole administration among patients with hematologic malignancies who receive hematopoietic stem-cell transplants or intensive chemotherapy. *Bone Marrow Transplant* 39:425–429
- Valentini A, Pompanon F, Taberlet P (2009) DNA barcoding for ecologists. *Trends Ecol Evol* 24:110–117
- van de Peer Y, Baldauf SL, Doolittle WF, Meyer A (2000) An updated and comprehensive rRNA phylogeny of (crown) eukaryotes based on rate calibrated evolutionary distances. *J Mol Evol* 51:565–576
- Vences M, Thomas M, Bonett RM, Vieites DR (2005) Deciphering amphibian diversity through DNA barcoding: chances and challenges. *Philos Trans Soc Lond B* 360:1859–1868
- Vogelstein B, Gillespie D (1979) Preparative and analytical purification of DNA from agarose. *Proc Natl Acad Sci USA* 76:615–619
- Voigt K, Wöstemeyer J (2001) Phylogeny and origin of 82 zygomycetes from all 54 genera of the Mucorales and Mortierellales based on combined analysis of actin and translation elongation factor EF-1alpha genes. *Gene* 270:113–120
- Voigt K, Cigelnik E, O'Donnell K (1999) Phylogeny and PCR identification of clinical important Zygomycetes based on nuclear ribosomal-DNA sequence data. *J Clin Microbiol* 37:3957–3964
- Voigt K, Hoffmann K, Einax E, Eckart M, Papp T, Vágvölgyi L, Olsson L (2009) Revision of the family structure of the Mucorales (Mucoromycotina, Zygomycetes) based on multigene-genealogies: Phylogenetic analyses suggest a bigeneric phycomycetaceae with spinellus as sister group to phycomyces. In: Gherbawy Y, Mach RL, Rai M (eds) *Current advances in molecular mycology*. Nova Science, New York, pp 263–312
- Walsh TJ, Groll A, Hiemenz J, Fleming R, Roilides E, Anaissie E (2004) Infections due to emerging and uncommon medically important fungal pathogens. *Clin Microbiol Infect* 10:48–66
- Weitzman I, McGough DA, Rinaldi MG, Della-Lata P (1996) *Rhizopus schipperae*, sp nov, a new agent of zygomycosis. *Mycotaxon* 59:217–225
- Wheeler QD (2004) Taxonomic triage and the proverty of phylogeny. *Philos Trans R Soc B* 359:571–583
- White TJ, Bruns T, Lee S, Taylor J (1990) Amplification and direct sequencing of fungal ribosomal RNA genes for phylogenetics. In: Innis MA, Gelfand DH, Sninsky JJ, White TJ (eds) *PCR protocols: a guide to methods and applications*. Academic Press, San Diego, pp 315–322
- White MM, James TY, O'Donnell K, Cafaro MJ, Tanabe Y, Sugiyama J (2006) Phylogeny of the Zygomycota based on nuclear ribosomal sequence data. *Mycologia* 98:872–884
- Wiemers M, Fiedler K (2007) Does the DNA barcoding gap exist? – a case study in blue butterflies (Lepidoptera: Lycaenidae). *Front Zool* 4:8
- Wollenweber HW, Reinking OA (1935) *Die Fusarien, ihre Beschreibung. Schadwirkung und Bekämpfung* Parey, Berlin, pp 1–355

- Woo PC, Zhen H, Cai JJ, Yu J, Lau SK, Wang J, Teng JL, Wong SS, Tse RH, Chen R, Yang H, Lui B, Yuen KY (2003) The mitochondrial genome of the thermal dimorphic fungus *Penicillium marneffei* is more closely related to those of molds than yeasts. *FEBS Lett* 555:56–477
- Yarlett N, Orpin CG, Munn EA, Yarlett NC, Greenwood CA (1986) Hydrogenosomes in the rumen fungus *Neocallimastix patriciarum*. *Biochem J* 15:729–739
- Zheng RY, Chen GQ, Liu XY (2000) *Rhizopus americanus* stat. nov. *Mycosystema* 19:473–477
- Zheng RY, Chen GQ, Huang H, Liu XY (2007) A monograph of *Rhizopus*. *Sydowia* 59:273–372
- Zycha H (1935) Pilze II. Mucorineae. *Krypt Fl Mark Brandenburg* 6a, Leipzig
- Zycha H, Siepmann R, Linnemann G (1969) Mucorales. eine beschreibung aller gattungen und arten dieser pilzgruppe. *J Cramer, Lehre*

# Chapter 12

## Advances in Detection and Identification of Wood Rotting Fungi in Timber and Standing Trees

Giovanni Nicolotti, Paolo Gonthier, and Fabio Guglielmo

**Abstract** Wood rotting fungi are reported as a major source of economic losses in both timber production and wood in service, and one of the main causes of tree wind throws and limb failures. Since the biology of these fungi is varied, their detection and identification are important for the application of appropriate management strategies and control measures. Following an overview of traditional and biochemical diagnostic techniques, whose usefulness is frequently limited either by their reliance on the sporadically emerging and rarely visible fruit bodies, or by the need of a preliminary isolation step, we discuss on DNA-based techniques that have been developed to detect and early identify wood rotting fungi in timber and in standing trees.

### 12.1 Introduction

Wood rotting fungi, also named decay fungi or rots, are the primary biotic decomposers of the wood because of their ability to break down lignified cell walls (Blanchette 1991; Jasalavich et al. 2000). Except for few ascomycetes, all wood attacking fungi are basidiomycetes primarily belonging to *Agaricales*, *Hymenochaetales*, *Polyporales*, and *Russulales* (Kirk et al. 2001). Based on their enzymatic capabilities, the decay fungi are divided into brown rot fungi, which preferentially attack and rapidly depolymerize cellulose and hemicelluloses, and white rot fungi, which can progressively degrade both carbohydrates and lignin (Blanchette 1991; Worrall et al. 1997). The structural deterioration of wood, determined by both types of rots, is an essential process in carbon and nitrogen recycling of forest ecosystems,

---

G. Nicolotti, P. Gonthier, and F. Guglielmo

Di.Va.P.R.A., Department of Exploitation and Protection of the Agricultural and Forestry Resources, Plant Pathology, University of Torino, via L. da Vinci 44, I-10095, Grugliasco (TO), Italy

e-mail: giovanni.nicolotti@unito.it

but can represent a serious threat leading to considerable problems in the urban context as well as in commercial forestry and plantations. In the urban environment, wood decay fungi can have a negative impact on tree stability (Lonsdale 1999). Furthermore, they are deemed to be responsible for most of damages of structural wood in buildings (Schmidt 2007). In forests and plantations for timber production and, to a lesser extent, in several fruit tree crops, root and butt rot diseases can cause severe economic losses (Bahnweg et al. 2002; Utomo and Niepold 2000). At any rate, timely detection and careful identification of wood rotting fungi are essential to define the most appropriate management strategies and control measures. Moreover, effective identification methods may be basic tools for studies focused on epidemiology, ecology, and biology of wood decay fungi. The late and occasional occurrence of visible rot symptoms and signs, such as the emergence of fruit bodies, can lead either to overlooking rot infections or to make identification of wood decay fungi unfeasible. This relevant issue has led to the development of several alternative techniques to efficiently detect and identify wood rotting fungi.

Following a general overview of the problems and risks caused by rots in both standing trees and wood in service, as well as of the most hazardous fungi involved, this chapter is focused on methods for detection and identification of wood rotting fungi. Recently developed diagnostic techniques are discussed in terms of advances upon traditional methods, limits, and fields of application. Relevance is given to DNA-based techniques allowing for early identification of rots directly from wood.

## **12.2 Problems and Risks Related to Wood Rotting Fungi**

### ***12.2.1 Indoor Wood Rotting Fungi***

Indoor wood decay fungi, also named house rots, figure prominently amongst the economically most important wood inhabiting fungi (Schmidt 2007). Indeed, it has been estimated that the cost for repairing damages caused by rots to timber used in construction in 1977 in the UK amounted to £3 millions per week (Rayner and Boddy 1988). The rise of wood moisture content, due to general building defects or to the presence of permanent water vapor sources, can lead to environmental conditions suitable for fungal infections. Based on the extent of the damage and on the fungal species involved in the decay process, remedial treatments range from expensive refurbishment methods to a more practical disposal of moisture sources (Schmidt 2007). Not all indoor wood decay fungi are in fact problematic, and the knowledge of their physiological requirements is important to develop environmentally friendly control strategies (Högberg and Land 2004; Schmidt 2007). Identification of the house rots is therefore important for management purposes.

Several studies have been focused on the abundance, economic significance, and biology of indoor wood inhabiting fungi (Bech-Andersen 1995; Gilbertson and



Ryvarden 1987; Huckfeldt and Schmidt 2006; Jellison et al. 2004). Brown rot basidiomycetes have been reported as the most common and hazardous indoor wood decay fungi. Among them, the dry rot fungi *Serpula lacrymans* (Wulfen:Fr.) and *Meruliporia incrassata* (Berk. & Curt.) are extremely destructive and among the least controllable fungi in Europe and the USA, respectively, mainly due to their ability to carry water and nutrients over long distances by means of strands (Jellison et al. 2004; Schmidt 2007). In Germany, *S. lacrymans* is clearly differentiated from other house rots as its presence requires considerably more rigorous and far-reaching control measures (Schmidt 2007). Other hazardous brown rot species include the cellar fungus *Coniophora puteana* (Schumach.) P. Karst., which proved to be able to cause decay even in wood with low moisture content (Huckfeldt and Schmidt 2006); the white polypores *Antrodia* spp. and *Oligoporus placenta* (Fr.) Gilb. & Ryvarden, mainly reported in the attic and upper floor; and the gill polypores *Gloeophyllum* spp., described as common destroyers of window and roof timber, with the ability to survive even at higher temperatures (Schmidt and Huckfeldt 2005). The Oak polypore, *Donkioporia expansa* (Desm.) Kotl. & Pouzar, has been reported as one of the few white rot basidiomycetes leading to relevant damages to indoor wood (Kleist and Seehann 1999).

### ***12.2.2 Wood Rotting Fungi and Tree Stability***

An accurate inspection of trees in public areas can be essential for correct tree management plans aimed at preventing dangerous situations such as wind throws or limb failures. Although main stems and root systems of standing trees are structurally optimized to withstand several times the average of the mechanical forces to which they are subjected from their own weight and from loading by wind, rain, and snow (Mattheck and Breloer 1995), the structural biological deterioration of wood can increase the occurrence of mechanical failures. This may lead to severe damages to properties and to personal injuries (Lonsdale 1999). Moreover, excessive pruning and root lesions, to which urban trees are frequently exposed, may favor infections of wood rot fungi. A timely detection of hazardous trees is achieved through a careful visual inspection of decay signs and structural weakness (Mattheck and Breloer 1992). Although this method, complemented with instrumental analyses (Habermehl et al. 1999; Müller et al. 2001; Nicolotti et al. 2003; Tomikawa et al. 1990), can allow detecting wood rot even at an incipient stage, it rarely enables the diagnosis of the decay causative agent. Because the biology and ecology of different rots are varied, the knowledge of the wood decay fungi involved in each instance is important to predict, to some extent, the severity of the fungal infection and, thus, to reliably assess potential risks of failure (Lonsdale 1999). Early identification of the causative agent is then crucial for rapidly progressing decay fungi that can turn a sound tree into a hazard in a short period of time.

Several comprehensive studies aimed at investigating and describing the most common rots in landscape and urban trees (Bernicchia 2005; Erkkilä and Niemelä

1986; Hickman and Perry 1997; Lonsdale 1999; Nicolotti et al. 2004a, b), as well as their invasiveness in different host species (Deflorio et al. 2008; Schwarze and Baum 2000; Schwarze et al. 2004; Swiecki et al. 2005; Terho et al. 2007), have allowed highlighting fungal *taxa* whose detection in a standing tree can be regarded as a hazard. Most of these *taxa* are white rot basidiomycetes: several species of *Ganoderma* and *Inonotus* have been reported as very active root and butt rot fungi potentially leading to extensive decay (Terho et al. 2007); *Armillaria* (Fr.:Fr.) Staude species are known to be dangerous root rot fungi occurring with high frequency even in urban environment (Guglielmo et al. 2008a); *Phellinus* spp. and *Perenniporia fraxinea* (Bull.) Ryvarden are deemed to be widespread butt and stem decay agents causing an intensive white rot (Bernicchia 2005; Nicolotti et al. 2004a, b; Swiecki et al. 2005). Although rarely found in hardwoods of urban environment, the brown rot *Laetiporus sulphureus* (Bull.) Murril is considered a hazardous root decay agent (Bernicchia 2005; Nicolotti et al. 2004a, b). Finally, the ascomycete *Kretzschmaria deusta* (Hoffm.) P.M.D. Martin has been recently proved to be strongly invasive in living stems of different deciduous hosts (Deflorio et al. 2008).

### 12.2.3 *Rot Diseases and Timber Production*

Although root and butt rots represent one of the driving forces leading to spatial and temporal diversification of forests, rot diseases figure amongst the most prominent causes of cull in timber production, resulting in considerable economic losses worldwide (Delatour 1980; Hansen and Goheen 2000). Indeed, in conifer stands aimed at timber production, often characterized by intensive thinning and monoculture, rot frequency can amount up to 20% (Piri 1996). Since most of the rot fungi can display host preference or specificity, and peculiar spreading and infection biology, management practices and control measures to limit rot diseases in forests are strongly dependent on precise and accurate identifications of the disease agent. Several *taxa* within the *Armillaria* and *Heterobasidion annosum* (Fr.) Bref. species complexes are deemed to be responsible for most of the root and butt rot diseases of conifers and hardwoods in natural forest stands and plantations throughout the northern temperate regions of the world (Chase and Ullrich 1988; Kile et al. 1991). As an example, *taxa* included in the *Heterobasidion annosum* species complex are reported to cause losses for more than €800 millions per year just in Europe (Woodward et al. 1998). The complex genus *Armillaria* encompasses about 40 biological species of varying geographic distributions, host ranges and virulence (Pegler 2000; Watling et al. 1991). *Armillaria mellea* (Vahl: Fries) Kummer and *A. ostoyae* (Romagnesi) Herink. have been reported as aggressive rot pathogens, whereas *A. gallica* Marxmuller and Romagnesi, *A. cepistipes* Velenovsky, *A. borealis* Marxmuller and Korhonen, and *A. tabescens* (Scopoli: Fries) Emel figure as secondary pathogens or weak parasites (Guillaumin et al. 1985; Kile et al. 1991; Wargo and Harrington 1991). Most of the *Armillaria* species are able to spread over long distances by means of rhizomorphs despite absence of root

contacts between adjacent trees. Before forest stand regeneration, careful removal of stumps or dying root systems is thus advisable to reduce fungal inoculum, especially when aggressive pathogenic *Armillaria* species are detected.

*Heterobasidion annosum sensu lato* (s.l.) is a species complex including three European species, namely, *H. abietinum* Niemelä & Korhonen, *H. annosum sensu stricto* (s.s.), and *H. parviporum* Niemelä & Korhonen, and two North American intersterility groups (ISGs), *H. annosum* ISG P (Am-P) and *H. annosum* ISG S (Am-S). Each *taxon* within *H. annosum* s.l. is characterized by distinct host specialization: *H. abietinum*, *H. parviporum*, and Am-S have been reported mostly as butt rot agents on spruce or fir trees, whereas *H. annosum* s.s. and *H. annosum* Am-P are associated with root rot and mortality of pines (Korhonen and Stenlid 1998). Primary infection occurs by means of airborne basidiospores on fresh stumps or wounds, and secondary infection by vegetative spreading from stump to tree or from tree to tree through root contacts. Treating fresh stumps with chemicals or biotic competitors, as well as avoiding thinnings and clearcuttings in periods of abundant sporulation, are important preventive control measures against this pathogen (Gonthier et al. 2005; Möykkynen and Miina 2002; Nicolotti and Gonthier 2005). The identification of *H. annosum* species infecting a stand can be important for the selection of tree species to be used for reforestation (Hantula and Vainio 2003).

*Phellinus weirii* (Murr.) Gilb. *sensu lato* and *Inonotus tomentosus* (Fr.) Teng are reported as aggressive root rot pathogens that can cause extensive wood losses and reduce productivity in conifer stands especially in North America (Germain et al. 2002; Hansen and Goheen 2000). Finally, although further investigations are needed, several species of *Ganoderma*, *Phellinus*, and *Phlebia* are responsible for harmful root and butt rot diseases affecting hardwood plantation for timber and biomass production in Asia (Lee 2000; Sahara et al. 2002; Utomo and Niepold 2000).

#### **12.2.4 Root and Butt Rot Diseases and Fruit Tree Plantations**

Several root and basal stem rots have been reported as significant diseases in fruit tree plantations, and decay agents are capable of surviving in the soil for several years (Amenduni et al. 2001; Khairudin 1995). Curative measures are, in general, expensive and not always effective, owing to the fact that visible disease symptoms appear at a very late stage of infection (Utomo and Niepold 2000). Preventive strategies based on the use of pathogen-free propagating materials and planting in noninfested soils are the most appropriate control measures (Schna and Ippolito 2003). Detection and early identification tools are thus important to limit the spread of these diseases in fruit tree plantations.

*Rosellinia necatrix* (Prill.) and *A. mellea* are dangerous root rot agents of fruit and forest trees with a widely distribution throughout temperate regions (Anselmi and Giorelli 1990; Wargo and Harrington 1991). Basal stem rot caused by

pathogenic *Ganoderma* spp. has been reported to severely reduce yearly harvest of oil palm crops in Asia (Utomo and Niepold 2000).

## 12.3 Traditional Techniques of Identification of Wood Rotting Fungi

### 12.3.1 Analysis of Fruit Bodies and Mycelial Strands

Conventional identification methods of wood decay fungi mostly rely on visual analysis of fruit bodies. Dichotomous keys to species, available for several lignicolous basidiomycetes (Bernicchia 2005; Breitenbach and Kränzlin 1986; Hickman and Perry 1997; Hjortstam et al. 1978), are based on macromorphology of the basidioma and hymenophores, and on micromorphology of hyphal system, hymenial organs, and spores. Determination of fungal species through the use of these keys often requires a deep mycological background. Simplified keys for the identification of several wood rotting fungi in urban and landscape trees proved to be suitable for discrimination at the genus level (Intini et al. 2000; Lonsdale 1999; Strouts and Winter 1994). Because aggressiveness and ability to overcome host defenses can vary among different species within genera (Schwarze and Baum 2000), identification at a species level is often more useful for tree management purpose. Recently, field keys based on macroscopic observations of basidiomata, their longitudinal cross-sections, and color of spore print have been successfully validated and they include the most important and widespread European wood rot basidiomycetes in standing trees (Gonthier and Nicolotti 2007). Macroscopic and microscopic analysis of fruit bodies, as well as of mycelial strands, can be successfully used to identify house rots (Bravery et al. 2003; Huckfeldt and Schmidt 2006).

Although this diagnostic method can be fast and reliable, it rarely allows for early identification of wood rotting fungi. Indeed, fruit bodies and/or mycelial strands of several wood decay fungi are rarely or sporadically visible and they usually emerge at advanced stages of the fungal infection (Palfreyman et al. 1991; Terho et al. 2007). This may represent a serious problem for several brown rots of wood in service, which can rapidly and drastically reduce wood strength at incipient stages, and for rapidly progressing root and butt rot agents of standing trees, which can represent a serious hazard in the urban environment.

### 12.3.2 Analysis of Pure Fungal Cultures

Analysis of pure fungal cultures isolated from mycelium and/or decayed wood may be used when no fruit bodies are available. Keys based on growth rate, microscopic features, and enzymatic capabilities of mycelia have been published for the identification of several basidiomycetes at the species level (Lombard and Chamuris

1990; Nobles 1965; Stalpers 1978). Moreover, sexual or mating compatibility tests, by means of pairing the unknown isolate with known haploid testers, may be efficient diagnostic tools. A sexually compatible mating results in the production of a genetic stable heterokaryotic mycelium, visible both by changes in culture morphology or by microscopic observations for the presence of clamp connections at some or most septa (Harrington et al. 1989; Ullrich and Anderson 1978). Mating tests have been extensively used for the discrimination of species within *Armillaria* and *Heterobasidion annosum* species complexes (Anderson 1986; Korhonen 1978).

Diagnostic methods based on pure culture analysis and tests are time-consuming and often unsuited to distinguish between closely related species (Schmidt 2007). Moreover, isolation of wood rotting fungi from environmental samples is often impractical, despite the use of selective media, due to the presence of fast growing fungal contaminants.

## 12.4 Biochemical Techniques

### 12.4.1 Protein-Based Techniques

Identification of wood decay fungi by means of analysis of their proteins includes sodium dodecyl sulfate polyacrilamide gel electrophoresis (SDS-PAGE) and isozyme analysis. SDS-PAGE is based on the analysis of electrophoretic patterns of whole cell proteins, after denaturation by means of chemical treatments. This method has been used for the discrimination, at specific and subspecific levels, of several indoor wood decay fungi (Palfreyman et al. 1991; Schmidt and Moreth 1995). Analysis of isozymes, which are proteins with multiple forms but with similar or identical enzymatic properties, consists of an electrophoresis followed by treatment with dye-forming substrate for the target enzyme. The resulting isoenzymatic profiles can allow differentiation of closely related species. This technique has been extensively used for studies on inter and intraspecific variability within *Armillaria* and *Heterobasidion annosum* species complexes (Otrosina et al. 1992, 1993; Rizzo and Harrington 1993; Wahlstrom et al. 1991).

Both the above-described techniques require the isolation of pure fungal cultures and a large amount of fungal tissues. Moreover, protein profiles can be highly affected by factors related to environment and the stage of fungal development. The procedure to develop systems yielding consistent results may then be work and time-consuming.

### 12.4.2 Immunological Techniques

Immunological methods are based on the use of polyclonal antisera or monoclonal antibodies obtained to specifically recognize antigens, such as proteins or

polysaccharides, typical of the species to be identified. Several methods, such as dot-blot immunoassay, enzyme-linked immunosorbent assay (ELISA), and electron microscopy immunolabeling have been developed for detection and/or quantification of the most serious indoor wood decay fungi (Clausen 1997; Jellison and Goodell 1988; Palfreyman et al. 2001). This technique proved to be useful to early detect rots directly from extracts of wood, without the need of any prior isolation and pure culturing step (Clausen and Kartal 2003). ELISA tests have been successfully developed for rapid detection from wood samples of *A. mellea* and *A. ostoyae* (Priestley et al. 1994) and pathogenic *Ganoderma* species on oil palm (Utomo and Niepold 2000).

Although several immunological methods, such as ELISA, are promising techniques for screening a large number of samples, cross-reaction may occur with nontarget organisms (Schmidt 2007). Further, sensitivity of immunological assays can often be inhibited by wood extractives (Jellison and Goodell 1989).

## 12.5 DNA-Based Techniques

The great potential of DNA-based techniques, over traditional and biochemical identification methods, relies on the chance to select diagnostic markers in coding as well as noncoding DNA regions of the nuclear and mitochondrial genome. Indeed, nucleotide sequence polymorphism of these regions can provide a large amount of diagnostic characters suitable for identification of fungi at different taxonomic levels independently of any factors related to environment and stage of fungal development. Although DNA hybridization techniques combined with the digestion of nuclear and mitochondrial DNA (nuc- and mt-DNA) by means of restriction endonucleases proved to be powerful for identification of *Armillaria* at a specific and subspecific rank (Jahnke et al. 1987; Anderson et al. 1989; Schulze et al. 1995), this method is too time-consuming and expensive for routine diagnosis of rots. Conversely, techniques based on polymerase chain reaction (PCR) are valuable alternative identification tools for specific, sensitive, and rapid routine diagnoses of wood decay fungi. As immunological methods, most PCR-based methods allow fungal identification directly from wood, without the need of any pure fungal culture isolation step. Following a brief overview of the protocols developed to efficiently extract DNA from wood, we describe the most important PCR-based methods used for identification of wood rotting fungi.

### 12.5.1 DNA Extraction from Wood

While starting from fungal mycelium easy and rapid methods of hyphal suspension in sterile water followed by freezing and thawing steps may be suitable for PCR amplification of fungal ribosomal DNA (rDNA) (Garbelotto et al. 1996; Harrington

and Wingfield 1995); when wood samples have to be tested, more elaborate protocols are necessary for efficiently extracting fungal DNA. Wood extractives, namely polyphenols, tannins, resin acids, and polysaccharides, are known as potential PCR inhibitors (Bahnweg et al. 1998). Further, in decayed wood, DNA molecules can be subjected to partial degradation (Jasalavich et al. 2000). Efficient wood DNA extraction is thus crucial for both reliability and sensitivity of PCR-based methods.

In a study focused on DNA isolation from recalcitrant materials, such as conifer tree roots and bark, Bahnweg et al. (1998) developed a highly efficient cetyltrimethylammonium bromide (CTAB) protocol consisting of an early extraction or precipitation of inhibiting components under conditions minimizing oxidation reactions. Since this method is work- and time-consuming, and requires several harmful reducing agents and organic solvents, it is unsuited to rapid routine diagnostics. Other protocols, based on serial extractions with either CTAB or SDS, and organic solvents (Jasalavich et al. 2000; Oh et al. 2003; Suhara et al. 2005; Vainio and Hantula 2000) efficiently provide amplifiable DNA from both incipient and advanced decayed wood but still result in long procedures. Rapid and organic solvent-free protocols consisting either of serial CTAB extractions (Råberg et al. 2005) or CTAB extraction followed by a final DNA purification with GENCLEAN Kit (Qbiogene, Carlsbad, CA, USA) (Allmér et al. 2006) or polyvinylpyrrolidone (PVPP) spin columns (Schena and Ippolito 2003) have proven to be useful in extracting fungal DNA from wood. Finally, in a comparative assay of different DNA extraction methods (Guglielmo 2005), a protocol entirely based on a kit developed to extract DNA from “stool” (Qiagen, Valencia, CA, USA) proved to be as efficient as the Bahnweg protocol for fungal DNA isolation from wood of different tree species. Since this method is rapid and no harmful reagent handling steps are necessary, it has been extensively and successfully used for the validation of PCR-based diagnostic methods on wood samples collected from different host tree species (Guglielmo et al. 2007, 2008b). Despite the cost, DNA extraction kits are very useful for reliable and rapid routine diagnostics.

### **12.5.2 RAPD-PCR**

Random amplified polymorphic DNA (RAPD) analysis consists of a PCR with an arbitrary and short oligonucleotide which can prime the amplification of DNA fragments when its complementary site occurs as reverted repeats in the genome (Williams et al. 1990). DNA polymorphism among different individuals is thus detected as the presence/absence of the amplicons that compose their RAPD profile.

Schmidt and Moreth (1998) proposed RAPD markers that may be useful to distinguish *S. lacrymans* from other indoor decay fungi. Strain identification by means of RAPD analysis was paramount to prove the different origins of several *C. puteana* cultures that had been supposed to be strain Ebw15, an obligatory test fungus used to evaluate the efficacy of wood preservatives according to the European Standard EN113 (Göller and Rudolph 2003). RAPD analysis has been



used to differentiate genotypes of *Armillaria* spp. in natural populations of different geographical areas, providing markers for the distinction of both a single clone (Smith et al. 1992) and a single species (Schulze et al. 1997). Finally, this method has been extensively used to study the genetic variability among and within ISGs of *H. annosum* (Garbelotto et al. 1993; Karjalainen 1996).

Although RAPD analysis is fast and easy to perform and does not require prior information of the target DNA site, it can have limits of reproducibility. Moreover, this technique should not be applied on DNA extracted from environmental samples, i.e., wood, potentially holding several different microorganisms.

### 12.5.3 PCR-RFLP

Restriction fragment length polymorphism (RFLP) analysis is based on the use of restriction endonucleases, enzymes which recognize specific nucleotide sequences (restriction sites) and consequently cut DNA at these or other points. Polymorphism in these sites can thus be used to distinguish between different individuals. As stated above, costly and elaborate Southern blotting and labeled probing techniques are needed to detect RFLP of total nuc- and/or mt-DNA. Conversely, RFLP applied to PCR-amplified DNA fragments can provide valuable diagnostic markers easily detectable through a simple agarose gel electrophoresis. Since nuc- and mt-rDNA loci include both conserved and variable domains (Hong et al. 2002; White et al. 1990), they figure amongst the most popular DNA target sites for the development of most of the DNA-based fungal diagnostic techniques, including RFLP markers. Indeed, in the nuc-rDNA, internal transcribed spacers (ITSs) and nontranscribed intergenic spacers (IGSs) display high inter and intraspecific variability, whereas ribosomal genes, such as large and small rDNA (nuc-LrDNA and nuc-SrDNA), are more useful for identification at higher taxonomic levels (Bruns and Shefferson 2004; Guerin-Laguette et al. 2002). Multicopy arrangement and highly conserved priming sites, typical of both nuc- and mt-rDNA, allow DNA amplification from virtually all fungi, even if the starting sample is lacking in quantity or quality (Jasalavich et al. 2000; White et al. 1990).

Amplified ribosomal DNA restriction analysis of ITS (ARDRA-ITS) has proven to be useful for the distinction of *S. lacrymans* from its closest relative *Serpula hymantioides* (Fr.) P. Karst. (Schmidt and Moreth 1999). Digestion of an IGS portion with a combination of restriction endonucleases allowed unambiguous identification of pure cultures of several *Armillaria* species from Europe (Sierra et al. 1999), North America (Harrington and Wingfield 1995; Sierra et al. 1999), and Japan (Matsushita and Suzuki 2005). RFLP of PCR-amplified ITS and IGS has been extensively used in several studies for the differentiation of *H. annosum* species and ISGs both in Europe and North America (Garbelotto et al. 1993; Gonthier et al. 2001; Kasuga and Mitchelson 2000; Kasuga et al. 1993). In a recent study, the development of RFLP of nuc-rDNA amplified fragments allowed the differentiation, within *P. weirii* complex, of *P. weirii sensu stricto* (s.s.) and



*Phellinus sulphurascens* Pilat, two species differing in pathogenicity but mostly undistinguishable by means of traditional methods (Lim et al. 2005). A wide collection of RFLP profiles based on a 1,800–1,900-bp-long region, including the ITS, allowed the differentiation among 48 out of 52 species of the European polypores analyzed (Fischer and Wagner 1999). A similar study, but restricted to RFLP analysis of ITS, has been performed to investigate wood inhabiting fungi in *Picea abies* of unmanaged forests (Johannesson and Stenlid 1999).

PCR-RFLP has proved to be a valuable and reproducible method for fungal identification at different taxonomic levels, but as RAPD markers when applied to DNA extracted directly from wood it can lead to unreliable results. A cloning step before the digestion of the amplified rDNA (Kennedy and Clipson 2003) can overcome this limit but it makes the method longer and more complex.

#### 12.5.4 T-RFLP

Terminal restriction fragment length polymorphism (T-RFLP) is an automated version of PCR-RFLP. Fluorescently labeled primers are used in PCR and a high-resolution capillary analyzer is used to investigate the digested fragments (Liu et al. 1997). In comparison to RFLP, only terminal digested fragments are detectable. This technique is a high-throughput fingerprinting method often used in studies of microbial communities (Edel-Hermann et al. 2004).

Through T-RFLP on ITS, *Coniophora puteana* has been detected directly from artificially inoculated wood samples at early stages of colonization, when no hyphae were visible at the microscope (Råberg et al. 2005). T-RFLP, visual fruit body inspection, and analysis of pure fungal cultures have been simultaneously employed to examine the composition and the abundance of wood inhabiting fungi in woody debris of a Norway spruce stand (Allmér et al. 2006). Although the number of fungal species detected by T-RFLP was lower than that obtained with the other two methods, it allowed the detection of unculturable wood decay basidiomycetes (Lim et al. 2005).

Although few applications of this method have been reported so far for diagnosis of wood rots, this technique is promising especially for rapid and simultaneous investigation of several fungi.

#### 12.5.5 Taxon-Specific Priming PCR

PCR with taxon-specific primers provides reliable tools for fungal diagnostics from both pure culture and environmental samples. The specificity of this method relies on the design of primers that anneal exclusively a complementary site unique for the taxon to be detected. If DNA of the target species is present, taxon-specific

oligonucleotides prime the amplification of DNA fragment of a peculiar size. As an added benefit, the simultaneous application of taxon-specific primers in multiplex PCR reactions can increase the diagnostic capacity of PCR without compromising the specificity of the analysis (Elnifro et al. 2000). A simple agarose gel electrophoresis can allow the detection of taxon-specific amplicons.

Species-specific oligonucleotides were designed on ITS to identify *S. lacrymans*, *D. expansa*, *C. puteana*, *Antrodia vaillantii* (DC.) Ryvarden, and *Gloeophyllum sepiarium* (Wulfen) P. Karst. (Moreth and Schmidt 2000; Schmidt and Moreth 2000). This technique can be useful to easily and rapidly detect, directly from wood samples, the economically most important basidiomycetes causing wood rot in European buildings (Table 12.1).

PCRs with specific ITS primers have been developed to detect European *Armillaria* species by Schulze et al. (1997) and Lochman et al. (2004). Further, primers developed by Lochman et al. (2004) through a nested PCR method enable the detection of *Armillaria* spp. directly from environmental samples, such as soil. Attempts to design specific primers for each European *Armillaria* species are reported in the study conducted by Sicoli et al. (2003) (Table 12.2).

A taxon-specific competitive priming (TSCP)-PCR, developed to identify in a single reaction the two north American *H. annosum* ISGs, Am-P and Am-S, allowed efficient typing of more than 500 fungal samples and to recover, first time in the field, a well-established hybrid between the two ISGs (Garbelotto et al. 1996). A similar approach has been used to study the abundance, potential dispersal range, and habitat of European *H. annosum* species in pure and mixed forests (Gonthier et al. 2001, 2003). While taxon-specific primers designed on mt-LrDNA with partially overlapping complementary sites allowed the distinction of *H. parviporum* and *H. abietinum*, the simultaneous use of universal fungal primers on the same region permitted the identification of the intronless *H. annosum* s.s. (Gonthier et al. 2003). For more practical purposes, PCR with primers designed on ITS allowed detecting both *H. annosum* s.s. and *H. parviporum* directly from increment cores of Norway

**Table 12.1** PCR assays, with reverse taxon-specific primers designed on ITS region, for the identification of indoor wood rotting fungi

Primer pairs	Primer sequence (5'-3')	Specificity/Amplicon size	References
ITS1 <sup>a</sup> L	tccgtaggtgaacctgcgg aatgttctctgcgacaacg	<i>S. lacrymans</i> /588 bp	Moreth and Schmidt (2000)
ITS1 H	tccgtaggtgaacctgcgg tcccacaaccgaacaatc	<i>S. hymantioides</i> /429 bp	Moreth and Schmidt (2000)
ITS1 C	tccgtaggtgaacctgcgg agtagcaagtaaggcataga	<i>C. puteana</i> /633 bp	Moreth and Schmidt (2000)
ITS1 D	tccgtaggtgaacctgcgg tcgccaaaacgcttcacggt	<i>D. expansa</i> /544 bp	Moreth and Schmidt (2000)
ITS1 A	tccgtaggtgaacctgcgg caccgataagccgactcatt	<i>A. vaillantii</i> /517 bp	Moreth and Schmidt (2000)
ITS1 G	tccgtaggtgaacctgcgg gttaataaaaaccgggtgag	<i>G. sepiarium</i> /398 bp	Moreth and Schmidt (2000)

<sup>a</sup>Universal forward primer designed by White et al. (1990)

**Table 12.2** PCR assays for the identification of important root and butt rot agents of forest trees

Primer pairs	Primer sequence (5'-3')	Specificity/Amplicon size	DNA target site	References
ARM-1	agggtatgtgcacgttcgac	<i>Armillaria</i> spp./660 bp <sup>a</sup>	ITS	Schulze et al. (1997)
ARM-2	ggaaagctaagctcgcgcta			
AR-1	ctgacctgttaaagggtatgtgc	<i>Armillaria</i> spp./690–	ITS	Lochman et al. (2004)
AR-2	aagctgaatcctcttacaagtcaa	724 bp <sup>b</sup>		
ATA1	ttgccttgaaccctgtataaaggc	<i>A. tabescens</i> /375–	IGS	Sicoli et al. (2003)
ATA2	tgccaaaatcggtgcacgccgc	381 bp <sup>b</sup>		
AMEL3	ttgctgtcttacgagctaag	<i>A. mellea</i> /631 bp	ITS	Sicoli et al. (2003)
ITS4 <sup>c</sup>	tcctccgcttattgatatgc			
AME1	aagaatcatgagatatcatcagt	<i>A. mellea</i> /364–387 bp <sup>b</sup>	IGS	Sicoli et al. (2003)
AME2	ttagaaaatccgccttagaaac			
ITS3 <sup>c</sup>	gcacgcgatgaagaacgcgac	<i>Armillaria</i> spp./184 bp	ITS	Guglielmo et al. (2007)
Armi2R	aaacccccataatccaatcc			
It-ITS-209-f	gctaaatccactttaaac	<i>I. tomentosus</i> /491 bp	ITS	Germain et al. (2002)
It-ITS-700-rc	aggagccgaccacaaaagat			
PW164	gcttccattttcttagg	<i>P. weirii</i> s.s./495 bp	ITS	Lim et al. (2005)
PW659	tcaaaaggcgtattaatg			

<sup>a</sup>The size is referred to the amplicon obtained from *A. ostoyae* DNA extracts

<sup>b</sup>Depending on the isolates or species considered, the size of amplicon varies between the reported values

<sup>c</sup>Universal primers designed by White et al. (1990)

spruce (Bahnweg et al. 2002), whereas primers designed on cloned DNA fragments derived from random amplified microsatellites (RAMS) markers proved to be suitable to distinguish *H. annosum* s.s. and *H. parviporum* (Hantula and Vainio 2003). A summary of taxon-specific priming PCRs developed for the identification of *H. annosum* species is reported in Table 12.3.

Taxon-specific primers were designed on ITS region for two other important root rot conifer pathogens, namely *P. weirii* s.s. and *I. tomentosus* (Germain et al. 2002; Lim et al. 2005) (Table 12.2), as well as for other significant hardwoods pathogens, such as *Ganoderma* species causing the basal stem rot of oil palm (Utomo et al. 2005); *Phlebia brevispora* Nakasone, involved in butt rot of Japanese cypress (Suhara et al. 2005); and *Phellinus noxius*, a destructive pathogen of several woody plants in Asia (Tsai et al. 2007).

Three multiplex PCRs based on 11 taxon-specific primers designed on either nuc- or mt-rDNA regions allowed detecting several decay fungi, such as *Armillaria* spp., *Ganoderma* spp., *Inonotus* spp., *K. deusta*, *Laetiporus* spp., *P. fraxinea*, and *Phellinus* spp., reported as hazardous for tree stability in Europe and North America (Guglielmo et al. 2007; Nicolotti et al. 2009). Two further multiplex PCR reactions were developed to detect and identify at subgeneric levels the most hazardous wood decay fungi belonging to *Ganoderma*, *Phellinus*, and *Inonotus* (Guglielmo et al. 2008b). These methods were validated in the field and proved to be highly sensitive, allowing the detection of down to 10<sup>-1</sup> pg of target DNA per 1 mg wood DNA extracts (Guglielmo et al. 2007). A summary of these multiplex PCRs, with related taxon-specific primers, is reported in Tables 12.4 and 12.5.

**Table 12.3** TSCP-PCR and PCR assays developed for identification of *H. annosum* species

Primers combination and sequence (5'-3')		Specificity/Amplicon size	Target site	References
Forward	Reverse			
ITS1F <sup>a</sup> (ctggcatttagagaagtaa)	ITS4	Fungi	ITS	Garbelotto et al. (1996)
ITS P1 (gtcggcgggtctttgatac)		<i>H. annosum</i> Am-P/518 bp		
ITS S1 (gccgcgtctctcacaact)	Mito7 (gccaatattttgctacc)	<i>H. annosum</i> Am-S/486 bp		
MLF (taaaaatttaattagccataa)	Mito5 (taagaccgctatawaccagac)	<i>H. annosum</i> s.s./230 bp	Mt-LrDNA	Garbelotto et al. (1998); Gonthier et al. (2001, 2003)
MLS (aaattagccatattttaaag.)	EfaHaRev (gcgagayaagaagtaatacagca)	<i>H. parviporum</i> /185 bp	EFA	Gonthier et al. (2007)
EfaHaFor (ctatgtcgcggtacagcttg)		<i>H. annosum</i> spp./169 bp		
EfaNAPFor (gtacatggctacigtaegttagatgc)		<i>H. annosum</i> Am-P/71 bp		
EFAEuPFor (atggctacigtaegttagatgc)		<i>H. annosum</i> s.s./69 bp		
MJ-F (ggctctgtctgcttgc)	MJ-R (ctgaagcacacctgcca)	<i>H. annosum</i> s.s./100 bp	IGS	Hantula and Vainio (2003)
KJ-F (ccattaacggaaccagctg)	KJ-R (gtcggctcattctgaactac)	<i>H. parviporum</i> /350 bp	Unknown	
HET-7 (ctctcacaactcttcg)	HET-8 (caggctcccacaactcg)	<i>H. annosum</i> spp./400 bp	ITS	Bahnweg et al. (2002)

<sup>a</sup>Universal primer designed by Gardes and Bruns (1993)

**Table 12.4** Multiplex PCR assays developed by Guglielmo et al. (2007) for identification of important wood rotting fungi hazardous for tree stability

Multiplex PCR	Primers combination and sequence (5'-3')		Specificity/Amplicon size	Target Site
	Forward	Reverse		
M1	ITS1F	ITS4	Fungi	ITS
		Gano2R (tatagattgtgataaacga)	<i>Ganoderma</i> spp./226-228 bp	
	F115 (taagcaccgtctgaaac)	Hyme2R (tgcdecccctgycggag)	<i>Inonotus</i> spp. and <i>Pheillinus</i> spp./111 bp	Nuc-LrDNA
	25sF (tggcagagaccgatagc)	Heri2R (cagcccttgcggcagt)	<i>Herictium</i> spp./199 bp	Nuc-LrDNA
M2		Lae1R (ccgagcaaacgaatgca)	<i>L. sulphureus</i> /146 bp	
		Pleu2R (aaaccaggagtacccctac)	<i>Pleurotus</i> spp./158 bp	ITS
	ITS3	Armi2R (aaaccataataccaatcc)	<i>Armillaria</i> spp./184 bp	ITS
	ITS3	PerR (atctgcaaacaccggaagt)	<i>P. fraxinea</i> /152 bp	
		Schi2R (ctccagcagacctccctc)	<i>Schizophyllum</i> spp./191 bp	
		Ste2R (gtcgaacaagcgcactaa)	<i>Stereum</i> spp./234-240 bp	
		Ustu2R <sup>b</sup> (gctcatctctacagcgagaa)	<i>K. deusta</i> /260 bp	
M3	MS1 <sup>a</sup> (cagcagcaagaatattagcaatg)	TraR (ttcatagttatggaaccgc)	<i>Trametes</i> spp./220 bp	Mt-SrDNA

<sup>a</sup>Universal primer designed by White et al. 1990<sup>b</sup>Primer designed by Nicolotti et al. (2009)**Table 12.5** Multiplex PCR assays developed by Guglielmo et al. (2008b) for identification of hazardous wood rotting fungi within *Ganoderma*, *Inonotus* and *Pheillinus*

Multiplex PCR	Primers combination and sequence (5'-3')		Specificity/ Amplicon size	Target site
	Forward	Reverse		
Mgano	ITS1-F	GadR (caggaacaagtgcgctc)	<i>G. adspersum</i> , <i>G. pfeifferi</i> , <i>G. applanatum</i> (from North America)/211 bp	ITS
		GapR (gacagcttcaagctcc)	<i>G. applanatum</i> (from Europe)/200 bp	
		GiR (ttcacgaagcccgcaag)	<i>G. lucidum</i> (from Europe)/193 bp	
		GrR (aaagcccgcttcaaacg)	<i>G. resinaceum</i> , <i>G. lucidum</i> (from North America)/178 bp	
Mhyme	25sF	FomR (cccagccatgatacaatag)	<i>Fomitiporia</i> ( <i>P. punctatus</i> , <i>P. robustus</i> )/258 bp	Nuc-LrDNA
		FuscR (cacacticegaagtgcc)	<i>Fuscoporia</i> ( <i>P. contiguis</i> , <i>P. gilvus</i> , <i>P. torulosus</i> )/225 bp	
		IdryaR (accgacataacacaagg)	<i>I. dryadeus</i> /254 bp	
		InocuR (cctcagccccaggt)	<i>Inocutis</i> ( <i>I. dryophilus</i> )/265 bp	
		InssR (gatgtgaccgctccgac)	<i>Inonotus</i> s.s. ( <i>I. anderssonii</i> , <i>I. hispidus</i> , <i>I. obliquus</i> )/214 bp	
		PhssR (ggcgctacattcccctcg)	<i>Pheillinus</i> s.s. ( <i>P. igniarius</i> , <i>P. tremulae</i> , <i>P. tuberculosus</i> )/173 bp	

*Taxon*-specific priming PCR is the major tool for detection and identification of wood rotting fungi. Indeed, this method is reproducible, specific, fast, easy to perform, and useful for analysis of environmental samples. However, a preliminary knowledge of the nucleotide sequence of target site is necessary, as well as a long work on primer design and testing for specificity and possible cross-reactions with other nontarget fungi.

### 12.5.6 Real-Time PCR

Real-time PCR combines the conventional PCR with the generation of a fluorescent signal that depends on the amount of amplified DNA in each cycle. A detection system allows the measurement of this signal throughout the reaction, providing a real-time analysis and quantification of the specific DNA targets (Schmittgen 2001). The initial DNA amount of target DNA in the reaction can be related to a cycle threshold ( $C_t$ ), defined as the cycle number at which there is a statistically significant increase of fluorescence. This method can thus be quantitative and does not require a further electrophoretic run to detect the amplicon. The most popular real-time PCR methods, such as Taq-man (Lee et al. 1993), Molecular beacons (Tyagi and Kramer 1996) and Scorpion-PCR (Whitcombe et al. 1999), are based on the use of a fluorescent reporter dye and a quencher linked to probes. These probes are designed to be specific to a complementary site in the amplicon. Real-time PCR has thus an increased specificity with respect to conventional PCR.

A multiplex real-time PCR assay was developed to monitor the dynamics of *Picea abies*-*H. annosum* pathosystems (Hietala et al. 2003). In this study, real-time PCR proved to be more effective than traditional methods in screening clone resistance to the pathogen both under laboratory and field conditions. For diagnostic purposes, real-time PCRs were developed for *R. necatrix* and *Fuscoporia torulosa* (Pers.) T. Wagner & M. Fisch. (Campanile et al. 2008; Schena and Ippolito 2003). Real-time PCR allowed detection of *R. necatrix* both in infected plants and in contaminated soils with higher sensitivity than traditional isolation methods and baiting systems, respectively.

Although real-time PCR methods are more rapid than conventional PCR and, thus being more appropriate for routinely diagnostics, the need of costly machines and reagents has limited so far their use in the field of diagnostics of wood rotting fungi.

### 12.5.7 DNA Sequencing

As stated above, preliminary knowledge of nucleotide sequence of the target DNA region is paramount for the development of efficient diagnostic tools, such as

taxon-specific primers and RFLP markers. Additionally, the DNA sequence itself can also be used as a straightforward and powerful means of identification potentially exploiting polymorphism not only at a restricted site but everywhere in the DNA region considered. For this purpose, PCR product obtained from DNA extracts of the unknown sample is subjected, tout court or after a cloning step, to a sequencing reaction that leads, through high-resolution capillary analyzers, to a chromatogram displaying the complete nucleotide sequence for the DNA fragment. The unknown sequence is then compared, through Basic Local Alignment Search Tool (BLAST), to other sequences deposited in GenBank, which is an annotated database of all available nucleotide and amino acid sequences (Altschul et al. 1990). With the help of Expect (E) values, which report the significance of matches, it is possible to detect species displaying the highest sequence similarity with the unknown isolate. Large amounts of rDNA sequences, provided by several taxonomic and phylogenetic studies (Chillali et al. 1998; Hong and Jung 2004; Ko and Jung 1999; Larsson and Larsson 2003; Wagner and Fischer 2002), are increasingly available in GenBank for most of wood decay fungal taxa. The same is true for sequences of other nuc- and mt-DNA regions, such as ATP synthase subunit 6 (ATP), calmodulin (CAM), elongation factor 1- $\alpha$  (EFA), and glyceraldehyde 3-phosphate dehydrogenase (GPD) (Johannesson and Stenlid 2003; Linzer et al. 2008).

Direct sequencing of ITS combined with BLAST search has proved to be effective and reliable for the identification of fungi directly from wood in construction (Högberg and Land 2004). The comprehensive database of ITS and ribosomal genes sequences provided by Moreth and Schmidt (2005) for the most important house rot species may be helpful to increase the chance of identification by means of BLAST analysis.

Sequencing, after nested PCR, was helpful for the identification of *H. annosum* species in forests (Gonthier et al. 2003). Interestingly, sequencing was also helpful for the detection of an exotic root rot pathogen of forest trees in Italy (Gonthier et al. 2004). Sequence analysis of two nuclear loci and one mitochondrial locus showed that individuals from an Italian stone pine stand belonged to *H. annosum* Am-P (Gonthier et al. 2004). In a further study aimed at describing the patterns of invasion of this exotic pathogen, Gonthier et al. (2007) proved, through sequencing of the same loci, the occurrence of hybrids between North American and European *Heterobasidion* species.

Finally, ITS sequencing of DNA extracted from both fruit bodies or decayed wood is a method currently used to investigate the fungi associated to root and heart rot of *Acacia mangium* (Glen et al. 2006).

Although sequencing is very powerful for the identification of wood decay fungi, even directly from environmental samples after cloning, it appears too expensive as a routine analysis method. Furthermore, since in some cases species designation of the submitted organism in GenBank was wrong (Camacho et al. 1997; Redecker et al. 1999), a careful interpretation of the results from BLAST search is necessary.

**Table 12.6** Comparison of diagnostic techniques for wood rotting fungi in terms of preliminary requirements and main features

Diagnostic technique	Requirement of:		Specificity	Reproducibility	Cost	Time required (days)
	Fruit bodies	Isolation of pure cultures				
Analysis of fruit bodies	Yes	No	High	Medium	Very low	1-2
Analysis of pure fungal cultures	No	Yes	Medium	Medium	Low	20-60
Protein-based techniques	No	Yes	High	Low	Medium	7-15
Immunological techniques	No	No	Medium	Medium	Medium	2-15
RAPD-PCR	No	Yes	High	Low	Low	7-15
PCR-RFLP	No	Yes <sup>a</sup>	High	High	Medium	8-16
T-RFLP	No	No	High	High	High	3-5
Taxon-specific priming PCR	No	No	High	High	Low	1-3
Real-Time PCR	No	No	High	High	High	1-2
DNA-sequencing	No	Yes <sup>a</sup>	High	High	High	4-6
Microarrays	No	No	High	High	High	1-2

<sup>a</sup>Not required in case of preliminary cloning of PCR products



## 12.6 Conclusion and Perspectives

The introduction of DNA-based identification tools has overcome several limits of traditional methods and protein-based methods, allowing for rapid fungal diagnosis even in the absence of unequivocal rot signs and directly from wood without the need of a time-consuming isolation step (Table 12.6). Through DNA-based techniques, identification of wood decay fungi can be performed at early stages of fungal infection, making possible effective timely treatments against harmful house rots and reducing risks of tree failures in urban environment. Further, most DNA-based techniques provide straightforward diagnostic characters easy to interpret, independently of factors related to environment and stage of fungal development.

Advances in DNA-based phytodiagnosics are mainly addressed to the development of rapid methods allowing samples to be simultaneously screened for a large number of pathogens (Mumford et al. 2006). Multiplex taxon-specific PCRs have already allowed successful identification of several wood decay fungal species in a few assays (Guglielmo et al. 2007, 2008b). A more powerful tool for parallel testing of many targets in a single reaction is provided by microarrays, which are based on specific hybridization events between nucleic acid in a sample and known nucleic acid probes linked to a solid phase. A basic array method, the hybridization of immobilized sequence-specific oligonucleotide probes with PCR amplified fungal rDNA (SSOP), has already been proved to be a valuable and sensitive tool for simultaneous detection of decay fungi involved in the deterioration of wood products in service (Oh et al. 2003).

## References

- Allmér J, Vasiliauskas R, Ihrmark K, Stenlid J, Dahlberg A (2006) Wood-inhabiting fungal communities in woody debris of Norway spruce (*Picea abies* (L.) Karst.), as reflected by sporocarps, mycelial isolations and T-RFLP identification. *FEMS Microbiol Ecol* 55:57–67
- Altschul SF, Gish W, Miller W, Myers EW, Lipman DJ (1990) Basic local alignment search tool. *J Mol Biol* 215:403–410
- Amenduni T, Bazzoni A, Romanazzi G, Cariddi C, Vovlas N, Trisciuzzi N, Schena L, Potere O, Finetti-Sialer M, Myrta A (2001) Distribuzione dei patogeni delle drupacee in Puglia. Atti progetto PM A32 – Norme fitosanitarie e commercializzazione delle produzioni vivaistiche, Locorotondo, Bari, Italy, pp 143–179
- Anderson JB (1986) Biological species of *Armillaria* in North America: redesignation of groups IV and VIII and enumeration of voucher strains for other groups. *Mycologia* 78:837–839
- Anselmi N, Giorcelli A (1990) Factors influencing the incidence of *Rosellinia necatrix* Prill. in poplars. *Eur J Forest Pathol* 20:175–183
- Anderson JB, Bailey SS, Pukkila PJ (1989) Variation in ribosomal DNA among biological species of *Armillaria*, a genus of root-infecting fungi. *Evolution* 43:1652–1662
- Bahnweg G, Möller EM, Anegg S, Langebartels C, Wienhaus O, Sandermann H Jr (2002) Detection of *Heterobasidion annosum* s.l. [(Fr.) Bref.] in Norway spruce by polymerase chain reaction. *J Phytopathol* 150:382–389

- Bahnweg G, Schulze S, Moller EM, Rosenbrock H, Langebartels C, Sandermann H (1998) DNA isolation from recalcitrant materials such as tree roots, bark, and forest soil for the detection of fungal pathogens by polymerase chain reaction. *Anal Biochem* 262:79–82
- Bech-Andersen J (1995) The dry rot fungus and other fungi in houses. Husssvamp Laboratoriet, Holte, Denmark
- Bernicchia A (2005) Polyporaceae s.l. Ed. Candusso, Alassio, Italy, p 808
- Blanchette RA (1991) Delignification by wood-decay fungi. *Annu Rev Phytopathol* 29:381–398
- Bravery AF, Berry RW, Carey JK, Cooper DE (2003) Recognising wood rot and insect damage in buildings, 2nd edn. Building Research Establishment, Watford
- Breitenbach J, Kränzlin F (1986) Champignons de Suisse, Champignons sans Lames, vol 2. Mykologia, Luzern, p 412
- Bruns TD, Shefferson RP (2004) Evolutionary studies of ectomycorrhizal fungi: recent advances and future directions. *Can J Bot* 82:1122–1132
- Camacho FJ, Germandt DS, Liston A, Stone JK, Klein AS (1997) Endophytic fungal DNA, the source of contamination in spruce needle DNA. *Mol Ecol* 6:983–987
- Campanile G, Schena L, Luisi N (2008) Real-time PCR identification and detection of *Fuscoporia torulosa* in *Quercus ilex*. *Plant Pathol* 57:76–83
- Chase TE, Ullrich RC (1988) *Heterobasidion annosum*, root- and butt-rot of trees. *Adv Plant Pathol* 6:501–510
- Chillali M, Wipf D, Guillaumin JJ, Mohammed C, Botton B (1998) Delineation of the European *Armillaria* species based on the sequences of the internal transcribed spacer (ITS) of ribosomal DNA. *New Phytol* 138:553–561
- Clausen CA (1997) Immunological detection of wood decay fungi – an overview of techniques developed from 1986 to the present. *Int Biodeter Biodegrad* 39:133–143
- Clausen CA, Kartal SN (2003) Accelerated detection of brown-rot decay: comparison of soil block test, chemical analysis, mechanical properties, and immunodetection. *Forest Prod J* 53:90–94
- Deflorio G, Johnson C, Fink S, Schwarze FW (2008) Decay development in living sapwood of coniferous and deciduous trees inoculated with six wood decay fungi. *Forest Ecol Manag* 255:2373–2383
- Delatour C (1980) Le Fomes annosus (Fr.) Cke. en Europe de l'ouest: importance économique, orientation des recherches. In: Dimitri L (Ed.) Proceedings of the 5th International Conference on problems of root and butt rots in conifers, August 7–12, 1978, Kassel, F.R.G., Germany, pp 9–18
- Edel-Hermann W, Dreumont C, Perez-Piqueres A, Steinberg C (2004) Terminal restriction fragment length polymorphism analysis of ribosomal RNA genes to assess changes in fungal community structure in soils. *FEMS Microbiol Ecol* 47:397–404
- Elnifro EM, Ashshi AM, Cooper RJ, Klapper PE (2000) Multiplex PCR: optimization and application in diagnostic virology. *Clin Microbiol Rev* 13:559–570
- Erkkilä R, Niemelä T (1986) Polypores in the parks and forests of the City of Helsinki. *Karstenia* 26:1–40
- Fischer M, Wagner T (1999) RFLP analysis as a tool for identification of lignicolous basidiomycetes: European polypores. *Eur J Forest Pathol* 29:295–304
- Garbelotto M, Bruns TD, Cobb FW, Orosina WJ (1993) Differentiation of intersterility groups and geographic provenances among isolates of *Heterobasidion annosum* detected by random amplified polymorphic DNA assays. *Can J Bot* 71:565–569
- Garbelotto M, Orosina WJ, Cobb FW, Bruns TD (1998) The European S and F intersterility groups of *Heterobasidion annosum* may represent sympatric protospecies. *Can J Bot* 76:397–409
- Garbelotto M, Ratcliff A, Bruns TD, Cobb FW, Orosina WJ (1996) Use of taxon-specific competitive-priming PCR to study host specificity, hybridization, and intergroup gene flow in intersterility groups of *Heterobasidion annosum*. *Phytopathology* 86:543–551
- Gardes M, Bruns TD (1993) ITS primers with enhanced specificity for basidiomycetes – application to the identification of mycorrhizae and rusts. *Mol Ecol* 2:113–118

- Germain H, Laflamme G, Bernier L, Boulet B, Hamelin RC (2002) DNA polymorphism and molecular diagnosis in *Inonotus* spp. *Can J Plant Pathol* 24:194–199
- Gilbertson RL, Ryvarden L (1987) *Megasporoporia –Wrightoporia*, North American Polypores. *Fungiflora*, Oslo, Norway, pp 437–885
- Glen M, Potter K, Sulistyawati P (2006) Molecular identification of organisms associated with root and heart rot in *Acacia mangium*. In: Potter, K., Rimbawanto, A. and Beadle, C. ed., *Heart rot and root rot in tropical Acacia plantations*. Canberra. ACIAR Proc 124:55–59
- Göller K, Rudolph D (2003) The need for unequivocally defined reference fungi-genomic variation in two strains named as *Coniophora puteana* BAM Ebw. 15. *Holzforschung* 57:456–458
- Gonthier P, Garbelotto M, Nicolotti G (2003) Swiss stone pine trees and spruce stumps represent an important habitat for *Heterobasidion* spp. in subalpine forests. *Forest Pathol* 33:191–203
- Gonthier P, Garbelotto M, Varese GC, Nicolotti G (2001) Relative abundance and potential dispersal range of intersterility groups of *Heterobasidion annosum* in pure and mixed forests. *Can J Bot* 79:1057–1065
- Gonthier P, Garbelotto MM, Nicolotti G (2005) Seasonal patterns of spore deposition of *Heterobasidion* species in four forests of the Western Alps. *Phytopathology* 95:759–767
- Gonthier P, Nicolotti G (2007) A field key to identify common wood decay fungal species on standing trees. *Arboric Urban For* 33:410–420
- Gonthier P, Nicolotti G, Linzer R, Guglielmo F, Garbelotto M (2007) Invasion of European pine stands by a North American forest pathogen and its hybridization with a native interfertile taxon. *Mol Ecol* 16:1389–1400
- Gonthier P, Warner R, Nicolotti G, Mazzaglia A, Garbelotto MM (2004) Pathogen introduction as a collateral effect of military activity. *Mycol Res* 108:468–470
- Guerin-Laguette A, Matsushita N, Kikuchi K, Iwase K, Lapeyrie F, Suzuki K (2002) Identification of a prevalent *Tricholoma matsutake* ribotype in Japan by rDNA IGS1 spacer characterization. *Mycol Res* 106:435–443
- Guglielmo F (2005) A molecular approach for the detection and early identification of wood rotting fungi as useful tool in tree stability assessment, Ph.D. Thesis in Microbial Biotechnology, University of Florence, Florence, Italy, pp 131
- Guglielmo F, Bergemann SE, Gonthier P, Nicolotti G, Garbelotto M (2007) A multiplex PCR-based method for the detection and early identification of wood rotting fungi in standing trees. *J Appl Microbiol* 103:1490–1507
- Guglielmo F, Bergemann SE, Gonthier P, Nicolotti G, Garbelotto M (2008a) In: Garbelotto M, Gonthier, P (Eds.) *Proceedings of the 12th International Conference on Root and Butt Rots of Forest Trees*, Berkeley-California and Medford-Oregon, August 12–19, 2007. The University of California, Berkeley, USA, pp 196–200
- Guglielmo F, Gonthier P, Garbelotto M, Nicolotti G (2008b) A PCR-based method for the identification of important wood rotting fungal taxa within *Ganoderma*, *Inonotus* s.l. and *Phellinus* s.l. *FEMS Microbiol Lett* 282:228–237
- Guillaumin JJ, Lung B, Romagnesi H, Marxmüller H, Lamoure D, Durrieu G (1985) Systematics of the *Armillaria mellea* complex. *Phytopathological consequences*. *Eur J Forest Pathol* 15:268–277
- Habermehl A, Ridder HW, Seidl P (1999) Computerized tomographic systems as tools for diagnosing urban tree health. *Acta Hort* 496:261–268
- Hansen EM, Goheen EM (2000) *Phellinus weirii* and other native root pathogens as determinants of forest structure and process in Western North America. *Annu Rev Phytopathol* 38:515–539
- Hantula J, Vainio E (2003) Specific primers for the differentiation of *Heterobasidion annosum* (s. str.) and *H. parviporum* infected stumps in Northern Europe. *Silva Fenn* 37:181–187
- Harrington TC, Wingfield BD (1995) A PCR-based identification method for species of *Armillaria*. *Mycologia* 87:280–288
- Harrington TC, Worrall JJ, Rizzo DM (1989) Compatibility among host-specialized isolates of *Heterobasidion annosum* from western North America. *Phytopathology* 79:290–296

- Hickman GW, Perry EJ (1997) Ten common wood decay fungi on landscape trees-Identification handbook. Western Chapter, ISA, Sacramento
- Hietala AM, Eikenes M, Kvaalen H, Solheim H, Fossdal CG (2003) Multiplex real-time PCR for monitoring *Heterobasidion annosum* colonization in Norway spruce clones that differ in disease resistance. *Appl Environ Microbiol* 69:4413–4420
- Hjortstam K, Larsson KH, Ryvarden L (1978) The corticiaceae of North Europe, vol 1. Fungiflora, Oslo, Norway, p 60
- Högberg N, Land CJ (2004) Identification of *Serpula lacrymans* and other decay fungi in construction timber by sequencing of ribosomal DNA – a practical approach. *Holzforschung* 58:199–204
- Hong S, Jeong W, Jung H (2002) Amplification of mitochondrial small subunit ribosomal DNA of polypores and its potential for phylogenetic analysis. *Mycologia* 94:823–833
- Hong S, Jung H (2004) Phylogenetic analysis of *Ganoderma* based on nearly complete mitochondrial small-subunit ribosomal DNA sequences. *Mycologia* 96:742–755
- Huckfeldt T, Schmidt O (2006) Identification key for European strand-forming house-rot fungi. *Mycologist* 20:42–56
- Intini M, Panconesi A, Parrini C (2000) Malattie delle Alberature in Ambiente Urbano. CNR-IPAF, Florence, Italy, p 216
- Jahnke KD, Bahnweg G, Worrall JJ (1987) Species delimitation in the *Armillaria mellea* complex by analysis of nuclear and mitochondrial DNAs. *Trans Br mycol Soc* 88:572–575
- Jasalavich CA, Ostrofsky A, Jellison J (2000) Detection and identification of decay fungi in spruce wood by restriction fragment length polymorphism analysis of amplified genes encoding rRNA. *Appl Environ Microbiol* 66:4725–4734
- Jellison J, Goodell B (1988) Immunological detection of decay in wood. *Wood Sci Technol* 22:293–297
- Jellison J, Goodell B (1989) Inhibitory effects of undecayed wood and the detection of *Postia placenta* using the enzyme-linked immunosorbent assay. *Wood Sci Technol* 23:13–20
- Jellison J, Howell C, Schilling J, Goodell B, Quarles S (2004) Investigations into the biology of *Meruliporia incrassata*. In: International Research Group on Wood Preservation, IRG/WP Series Document 04-10508
- Johannesson H, Stenlid J (1999) Molecular identification of wood-inhabiting fungi in an unmanaged *Picea abies* forest in Sweden. *Forest Ecol Manage* 115:203–211
- Johannesson H, Stenlid J (2003) Molecular markers reveal genetic isolation and phylogeography of the S and F intersterility groups of the wood-decay fungus *Heterobasidion annosum*. *Mol Phylogenet Evol* 29:94–101
- Karjalainen R (1996) Genetic relatedness among strains of *Heterobasidion annosum* as detected by random amplified polymorphic DNA markers. *J Phytopathol* 144:399–404
- Kasuga T, Mitchelson KR (2000) Intersterility group differentiation in *Heterobasidion annosum* using ribosomal IGS1 region polymorphism. *Forest Pathol* 30:329–344
- Kasuga T, Woods C, Woodward S, Mitchelson K (1993) *Heterobasidion annosum* 5.8s ribosomal DNA and internal transcribed spacer sequence: rapid identification of European intersterility groups by ribosomal DNA restriction polymorphism. *Curr Genet* 24:433–436
- Kennedy N, Clipson N (2003) Fingerprinting the fungal community. *Mycologist* 17:158–164
- Khairudin H (1995) Basal stem rot of oil palm caused by *Ganoderma boninense*. In: PORIM International Palm Oil Congress: update and vision (Agriculture), 20–25 September 1993, Kuala Lumpur, Malaysia, pp 739–749
- Kile GA, McDonald GI, Byler JW (1991) Ecology and disease in natural forests. In: Shaw CG, Kile GA (eds) *Armillaria* root disease. Washington D.C, USDA Forest Service, pp 102–121
- Kirk PM, Cannon PF, David JC, Stalpers J (2001) Ainsworth and Bisby's dictionary of the fungi, 9th edn. CAB International, Wallingford, UK, p 655
- Kleist G, Seehann G (1999) Der Eichenporling, *Donkioporia expansa*, ein wenig bekannter Holzzerstörer in Gebäuden. *Z Mykol* 65:23–32

- Ko K, Jung H (1999) Phylogenetic re-evaluation of *Trametes consors* based on mitochondrial small subunit ribosomal DNA sequences. *FEMS Microbiol Lett* 170:181–186
- Korhonen K (1978) Intersterility groups of *Heterobasidion annosum*. *Commun Inst Forest Fenn* 94:1–25
- Korhonen K, Stenlid J (1998) Biology of *Heterobasidion annosum*. In: Woodward S, Stenlid J, Karjalainen R, Hüttermann A (eds) *Heterobasidion annosum: biology, ecology, impact and control*. CAB International, Wallingford, Oxon, UK, pp 43–70
- Larsson E, Larsson KH (2003) Phylogenetic relationships of russuloid basidiomycetes with emphasis on aphyllophoralean taxa. *Mycologia* 95:1037–1065
- Lee LG, Connell CR, Bloch W (1993) Allelic discrimination by nick-translation PCR with fluorogenic probes. *Nucleic Acids Res* 21:3761–3766
- Lee SS (2000) The current status of root diseases of *Acacia mangium* Willd. *Ganoderma* diseases of perennial crops. CAB International, Wallingford, Oxon, UK, pp 71–79
- Lim YW, Yeung YCA, Sturrock R, Leal I, Breuil C (2005) Differentiating the two closely related species, *Phellinus weirii* and *P. sulphurascens*. *Forest Pathol* 35:305–314
- Linzer RE, Orosina WJ, Gonthier P, Bruhn J, Laflamme G, Bussieres G, Garbelotto M (2008) Inferences on the phylogeography of the fungal pathogen *Heterobasidion annosum*, including evidence of interspecific horizontal genetic transfer and of human-mediated, long-range dispersal. *Mol Phylogenet Evol* 46:844–862
- Liu WT, Marsh TL, Cheng H, Forney LJ (1997) Characterization of microbial diversity by determining terminal restriction fragment length polymorphisms of genes encoding 16S rRNA. *Appl Environ Microbiol* 63:4516–4522
- Lochman J, Sery O, Mikes V (2004) The rapid identification of European *Armillaria* species from soil samples by nested PCR. *FEMS Microbiol Lett* 237:105–110
- Lombard FF, Chamuris GP (1990) Basidiomycetes. In: Wang CJK, Zabel RA (eds) *Identification manual for fungi from utility poles in the eastern United States*. American Type Culture Collection, Rockville, USA, pp 21–104
- Lonsdale D (1999) Principles of tree hazard assessment and management. Forestry Commission, London, UK, pp 388
- Matsushita N, Suzuki K (2005) Identification of *Armillaria* species in Japan using PCR-RFLP analysis of rDNA intergenic spacer region and comparisons of *Armillaria* species in the world. *J Forest Res* 10:173–179
- Mattheck C, Breloer H (1992) Tree monitoring with VTA – visual tree assessment. *Baumkontrolln mit VTA visual tree assessment*. *Gartenamt* 41:777–784
- Mattheck C, Breloer H (1995) The body language of trees: a handbook for failure analysis. *Research for Amenity Trees* 4. HMSO, London, p 240
- Moreth U, Schmidt O (2000) Identification of indoor rot fungi by taxon-specific priming polymerase chain reaction. *Holzforschung* 54:1–8
- Moreth U, Schmidt O (2005) Investigations on ribosomal DNA of indoor wood decay fungi for their characterization and identification. *Holzforschung* 59:90–93
- Möykkynen T, Miina J (2002) Optimizing the management of a butt-rotted *Picea abies* stand infected by *Heterobasidion annosum* from the previous rotation. *Scand J Forest Res* 17:47–52
- Müller U, Bammer R, Halmshlager E, Stollberger R, Wimmer R (2001) Detection of fungal wood decay using magnetic resonance imaging. *Holz Roh Werkst* 59:190–194
- Mumford R, Boonham N, Tomlinson J, Barker I (2006) Advances in molecular phytodiagnosics – new solutions for old problems. *Eur J Plant Pathol* 116:1–19
- Nicolotti G, Gonthier P (2005) Stump treatment against *Heterobasidion* with *Phlebiopsis gigantea* and some chemicals in *Picea abies* stands in the western Alps. *Forest Pathol* 35:365–374
- Nicolotti G, Gonthier P, Guglielmo F, Garbelotto M (2009) A biomolecular method for the detection of wood decay fungi: a focus on tree stability assessment. *Arboric Urban For* 35:14–19
- Nicolotti G, Gonthier P, Pecollo D (2004a) Ecologia e grado di preferenza d'ospite dei funghi agenti di carie/I parte. *Acer* 1:47–51

- Nicolotti G, Gonthier P, Pecollo D (2004b) Ecologia e grado di preferenza d'ospite dei funghi agenti di carie/II parte. *Acer* 2:59–67
- Nicolotti G, Socco LV, Martinis R, Godio A, Sambuelli L (2003) Application and comparison of three tomographic techniques for detection of decay in trees. *J Arboric* 29:66–78
- Nobles MK (1965) Identification of cultures of wood-inhabiting hymenomycetes. *Can J Bot* 43:1097–1139
- Oh SK, Kamdem DP, Keathley DE, Han KH (2003) Detection and species identification of wood-decaying fungi by hybridization of immobilized Sequence-Specific Oligonucleotide Probes with PCR-amplified fungal ribosomal DNA internal transcribed spacers. *Holzforchung* 57:346–352
- Otrosina WJ, Chase TE, Cobb FW Jr (1992) Allozyme differentiation of intersterility groups of *Heterobasidion annosum* isolated from conifers in the western United States. *Phytopathology* 82:540–545
- Otrosina WJ, Chase TE, Cobb FW Jr, Korhonen K (1993) Population structure of *Heterobasidion annosum* from North America and Europe. *Can J Bot* 71:1064–1071
- Palfreyman JW, Bruce A, Button D, Glancy H, Vigrow A, King B (2001) Immunological methods for the detection and characterisation of wood decay basidiomycetes. *Int Biodeter Biodegr* 48:74–78
- Palfreyman JW, Vigrow A, King B (1991) Molecular identification of fungi causing rot of building timbers. *Mycologist* 5:73–77
- Pegler DN (2000) Taxonomy, nomenclature and description of *Armillaria*. In: Fox RTV (ed) *Armillaria root rot: biology and control of honey fungus*. Intercept, Andover, pp 81–93
- Piri T (1996) The spreading of the S type of *Heterobasidion annosum* from Norway spruce stumps to the subsequent tree stand. *Eur J Forest Pathol* 26:193–204
- Priestley R, Mohammed C, Dewey FM (1994) The development of monoclonal antibody-based ELISA and dipstick assays for the detection and identification of *Armillaria* species in infected wood. In: Schots A, Dewey FM, Oliver RP (eds) *Modern assays for plant pathogenic fungi*. CAB International, Oxford, pp 149–156
- Råberg U, Högberg NOS, Land CJ (2005) Detection and species discrimination using rDNA T-RFLP for identification of wood decay fungi. *Holzforchung* 59:696–702
- Rayner ADM, Boddy L (1988) *Fungal decomposition of wood. Its biology and ecology*. Wiley, Chichester, pp 587
- Redecker D, Hijri M, Dulieu H, Sanders IR (1999) Phylogenetic analysis of a dataset of fungal 5.8S rDNA sequences shows that highly divergent copies of internal transcribed spacers reported from *Scutellospora castanea* are of Ascomycete origin. *Fungal Genet Biol* 28:238–244
- Rizzo DM, Harrington TC (1993) Delineation and biology of clones of *Armillaria ostoyae*, *A. gemina* and *A. calvescens*. *Mycologia* 85:164–174
- Schena L, Ippolito A (2003) Rapid and sensitive detection of *Rosellinia necatrix* in roots and soils by real time Scorpion-PCR. *J Plant Pathol* 85:15–25
- Schmidt O (2007) Indoor wood-decay basidiomycetes: damage, causal fungi, physiology, identification and characterization, prevention and control. *Mycol Prog* 6:261–279
- Schmidt O, Huckfeldt T (2005) Gebäudepilze. In: Müller J (ed) *Holzschutz im Hochbau*. Fraunhofer IRB, Stuttgart, pp 44–72
- Schmidt O, Moreth U (1995) Detection and differentiation of *Poria* indoor brown-rot fungi by polyacrylamide gel electrophoresis. *Holzforchung* 49:11–14
- Schmidt O, Moreth U (1998) Characterization of indoor rot fungi by RAPD analysis. *Holzforchung* 52:229–233
- Schmidt O, Moreth U (1999) Identification of the dry rot fungus, *Serpula lacrymans*, and the wild merulius, *S. himantioides*, by amplified ribosomal DNA restriction analysis (ARDRA). *Holzforchung* 53:123–128
- Schmidt O, Moreth U (2000) Species-specific PCR primers in the rDNA-ITS region as a diagnostic tool for *Serpula lacrymans*. *Mycol Res* 104:69–72

- Schmittgen TD (2001) Real-time quantitative PCR. *Methods* 25:383–385
- Schulze S, Bahnweg G, Möller EM, Sandermann H Jr (1997) Identification of the genus *Armillaria* by specific amplification of an rDNA-ITS fragment and evaluation of genetic variation within *A. ostoyae* by rDNA-RFLP and RAPD analysis. *Eur J Forest Pathol* 27:225–239
- Schwarze FW, Baum S (2000) Mechanisms of reaction zone penetration by decay fungi in wood of beech (*Fagus sylvatica*). *New Phytol* 146:129–140
- Schwarze FW, Engels J, Mattheck C (2004) *Fungal strategies of wood decay in trees*, 2nd edn. Springer, Berlin
- Sicoli G, Fatehi J, Stenlid J (2003) Development of species-specific PCR primers on rDNA for the identification of European *Armillaria* species. *Forest Pathol* 33:287–297
- Sierra AP, Whitehead DS, Whitehead MP (1999) Investigation of a PCR-based method for the routine identification of British *Armillaria* species. *Mycol Res* 103:1631–1636
- Smith ML, Bruhn JN, Anderson JB (1992) The fungus *Armillaria bulbosa* is among the largest and oldest living organisms. *Nature* 356:428–431
- Stalpers JA (1978) Identification of wood-inhabiting fungi in pure culture. *Stud Mycol* 16. Centraalbureau Schimmelcultures, Baarn, p 248
- Strouts RG, Winter TG (1994) *Diagnosis of ill-health in trees*. Forestry Commission, London, UK, pp 308
- Schulze S, Bahnweg G, Tesche M, Sandermann H Jr (1995) Identification of European *Armillaria* species by restriction-fragment length polymorphisms of ribosomal DNA. *Eur J For Pathol* 25:214–223
- Suhara H, Maekawa N, Kubayashi T, Kondo R (2005) Specific detection of a basidiomycete, *Phlebia brevispora* associated with butt rot of *Chamaecyparis obtusa*, by PCR-based analysis. *J Wood Sci* 51:83–88
- Suhara H, Maekawa N, Kubayashi T, Sakai K, Kondo R (2002) Identification of the basidiomycetous fungus isolated from butt rot of the Japanese cypress. *Mycoscience* 43:477–481
- Swiecki TJ, Bernhardt E, Drake C, Costello LR (2005) Relationships between *Phytophthora ramorum* canker (sudden oak death) and failure potential in coast live oak. In: *Proceedings of the Sudden Oak Death Second Science Symposium*, 19–21 January, 2005; Monterey. Pacific Southwest Research Station, Forest Service, U.S. Department of Agriculture, Albany, CA. Gen. Tech. Rep. PSW-GTR-196, pp 427–453
- Terho M, Hantula J, Hallaksela AM (2007) Occurrence and decay patterns of common wood-decay fungi in hazardous trees felled in the Helsinki City. *Forest Pathol* 37:420–432
- Tomikawa Y, Iwase Y, Arita K, Yamada H (1990) Nondestructive inspection of wooden poles using ultrasonic computed tomography. *IEEE Trans UFFC* 33:354–358
- Tsai JN, Hsieh WH, Ann PJ, Yang CM (2007) Development of specific primers for *Phellinus noxius*. *Plant Pathol Bull* 16:193–202
- Tyagi S, Kramer FR (1996) Molecular beacons: probes that fluoresce upon hybridization. *Nat Biotechnol* 14:303–308
- Ullrich RC, Anderson JB (1978) Sex and diploidy in *Armillaria mellea*. *Exp Mycol* 2:119–129
- Utomo C, Niepold F (2000) Development of diagnostic methods for detecting *Ganoderma*-infected oil palms. *J Phytopathol* 148:507–514
- Utomo C, Werner S, Niepold F, Deising HB (2005) Identification of *Ganoderma*, the causal agent of basal stem rot disease in oil palm using a molecular method. *Mycopathologia* 159:159–170
- Vainio EJ, Hantula J (2000) Direct analysis of wood-inhabiting fungi using denaturing gradient gel electrophoresis of amplified ribosomal DNA. *Mycol Res* 104:927–936
- Wagner T, Fischer M (2002) *Proceedings towards a natural classification of the worldwide taxa Phellinus s.l. and Inonotus s.l., and phylogenetic relationships of allied genera*. *Mycologia* 94:998–1016
- Wahlstrom K, Karlsson JO, Holdenrieder O, Stenlid J (1991) Pectinolytic activity and isozymes in European *Armillaria* species. *Can J Bot* 69:2732–2739
- Wargo PM, Harrington TC (1991) Host stress and susceptibility. In: Shaw CG, Kile GA (eds) *Armillaria root disease*. Washington D.C., USDA Forest Service, pp 88–101

- Watling R, Kile GA, Burdsall HHJ (1991) Nomenclature, taxonomy, and identification. In: Shaw CG, Kile GA (eds) *Armillaria* root disease. USDA Forest Service, Washington D.C., pp 1–9
- Whitcombe D, Theaker J, Guy SP, Brown T, Little S (1999) Detection of PCR products using self-probing amplicons and fluorescence. *Nat Biotechnol* 17:804–807
- White TJ, Bruns TD, Lee S, Taylor JW (1990) Amplification and direct sequencing of fungal ribosomal RNA genes for phylogenetics. In: Innis MA, Gelfand DH, Sninsky JJ, White TJ (eds) *PCR protocols: a guide to methods and applications*. Academic press, San Diego, USA, pp 315–322
- Williams JGK, Kubelik AR, Livak KJ, Rafalski JA, Tingey SV (1990) DNA polymorphisms amplified by arbitrary primers are useful as genetic markers. *Nucleic Acids Res* 18:6531–6535
- Woodward S, Stenlid J, Karjalainen R, Hüttermann A (Eds.) (1998) Preface. In: *Heterobasidion annosum, biology, ecology, impact and control*. CAB International, Oxon, UK, pp xi–xii
- Worrall JJ, Anagnost SE, Zabel RA (1997) Comparison of wood decay among diverse lignicolous fungi. *Mycologia* 89:199–219



# Chapter 13

## Molecular Diversity and Identification of Endophytic Fungi

Liang-Dong Guo

**Abstract** Endophytes are organisms inhabiting the living plant organs at some time in their life, without causing apparent harm to the host. Endophytic fungi, which have been widely studied in various geographical and climatic zones, are ubiquitous and occur within all examined plants including a broad range of host orders, families, genera, and species in diverse ecosystems. DNA fingerprinting and sequencing techniques employed in the population genetic diversity and in the detection and identification of endophytic fungi are summarized in this chapter.

### 13.1 Introduction

The term “endophyte,” originally introduced by De Bary (1866), refers to any organisms occurring within plant tissues, distinct from the epiphytes that live on plant surfaces. Carroll (1986) defines endophytes as mutualists, those fungi that colonize aerial parts of living plant tissues and do not cause symptoms of disease. Pathogenic and mycorrhizal fungi are excluded from this definition. Petrini (1991) considers that endophytes are organisms inhabiting the living plant organs at some time in their life, without causing apparent harm to the host. Therefore, latent pathogens known to live symptomlessly inside the host tissues and organisms that have an epiphytic phase in their life cycle are also endophytes. This latter definition is broad enough to include virtually any microbes and vascular plants that colonize the living internal tissues of plants (Bills 1996; Stone et al. 2000; Schulz and Boyle 2005, 2006). However, mycologists have come to employ this term “endophyte” (or endophytic fungi and fungal endophyte) only for those fungi that colonize a plant

---

L.-D. Guo

Systematic Mycology & Lichenology Laboratory, Institute of Microbiology, Chinese Academy of Sciences, Beijing 100101, China  
e-mail: guold@sun.im.ac.cn

without causing visible disease symptoms at any specific moment (Petrini 1991; Wilson 1995; Stone et al. 2000; Schulz and Boyle 2005).

Endophytic fungi, which have been widely studied in various geographical and climatic zones, are ubiquitous and occur within all examined plants including a broad range of host orders, families, genera, and species in diverse ecosystems (Petrini 1991; Wilson 1995; Stone et al. 2000; Guo 2001; Schulz and Boyle 2005; Li et al. 2007; Sun and Guo 2007; Wei et al. 2007; Guo et al. 2008; Sun et al. 2008). Most endophytic fungi are members of the Ascomycota or their mitosporic fungi but can also include some taxa of the Basidiomycota, Zygomycota, and Oomycota (Zheng and Jiang 1995; Sinclair and Cerkaskas 1996). Because the plant tissues are multilayered and spatially and temporally diverse microbial habitats, they support a rich and varied endophytic mycobiota that form specialized association with various plant species and tissues. Consequently, an accepted estimate of 1.5 million fungal species exists on earth primarily based on the ratios of vascular plants to fungal species at 1:6, but endophytic fungi have not been seriously taken into account in the estimation (Hawksworth 1991). Furthermore, Petrini (1991) suggests that there should be more than 1 million species of endophytic fungi remaining to be discovered and described in the world based on the ratios of vascular plants to fungal species at 1:4–5.

In the survey of endophytic fungal diversity, many techniques have been used; traditional cultivation-dependent techniques, however, have been routinely employed in previous studies. In the cultivation-dependent methods, living plant tissues are subjected to a serial process of surface sterilization in order to remove all organisms from the surface of plant tissues. Only internal fungi are isolated by means of the incubation of the plant samples onto nutrient plates. The cultivation-dependent techniques have generally involved three basic steps: (1) surface sterilization of plant tissues to kill any fungi on the host surface, (2) isolation of endophytic fungi growing out from samples placed onto nutrient agar, and (3) identification of the endophytic fungi based on morphological characteristics in culture. The advantage of the cultivation-dependent method is that this technique is effective for rapid recovery of a large number of endophytic fungal species from plant tissues. However, the study of endophytes is a method-dependent process. Endophytic fungal communities obtained from plants are directly affected by surface sterilization techniques and incubation conditions, and whether the isolates sporulate. Therefore, there are limitations in the cultural isolation techniques: (1) It is rather laborious and time intensive and is not suitable to compare large numbers of samples; (2) The large number of sterile isolates poses a special problem, because they cannot be identified to any taxonomic category, while various methods have been used to promote sporulation of isolates in order to overcome the shortcomings of some isolates failing to sporulate in culture (Taylor et al. 1999; Guo et al. 1998, 2000, 2008); (3) Some fungi may be missed as a result of failure to grow or some grow slowly and are easily outcompeted by fast-growing species in artificial conditions. In order to overcome the potential technical bias, cultivation-independent approaches, e.g., molecular techniques, to analyze endophytic fungal communities of plants are needed.

Molecular techniques have been successfully used in the detection and identification of mycorrhizal fungi in roots and soils (Gardes et al. 1991; Simon et al. 1993; Clapp et al. 1995; Chelius and Triplett 1999; Tedersoo et al. 2008); pathogenic fungi directly from within plant tissues (Schesser et al. 1991; Mills et al. 1992; Moukhamedov et al. 1994; Beck and Ligon 1995; Bates et al. 2001; Atkins et al. 2003, 2004); and fungi in Iceman's grass clothing (Rollo et al. 1995), bamboos (Zhang et al. 1997), and glacial ice strata (Ma et al. 1997). In this chapter, molecular techniques, i.e., DNA fingerprinting and sequencing methods, employed in the population genetic diversity and in the detection and identification of endophytic fungi, excluding mycorrhizal fungi, are briefly summarized.

## 13.2 Molecular Fingerprinting for Endophytic Fungal Population

DNA fingerprinting techniques, such as restriction fragment length polymorphism (RFLP), terminal-RFLP (T-RFLP), random amplified polymorphic DNA (RAPD), simple sequence repeat (SSR) or inter-SSR (ISSR), amplified fragment length polymorphism (AFLP), denaturing gradient gel electrophoresis (DGGE), temperature gradient gel electrophoresis (TGGE), and single-stranded conformation polymorphism (SSCP), are well established and have been successfully applied to assess the population genetic diversity and fungal communities in natural environment (Gardes et al. 1991; Simon et al. 1993; Chambers et al. 1999; Smit et al. 1999; Tooley et al. 2000; van Elsas et al. 2000; Bock et al. 2002; Klamer et al. 2002; Anderson et al. 2003; Huai et al. 2003; Jansa et al. 2003; Anderson and Cairney 2004; Liang et al. 2004, 2005). These techniques have recently been adopted and applied to assess the population structure and community of endophytic fungi.

### 13.2.1 RAPD and RFLP Techniques

The RAPD technique is used to investigate the genotypic diversity in populations of an endophytic fungus *Rhizoctonia parkeri* isolated from Douglas fir growing in various habitats (McCutcheon and Carroll 1993). A significantly lower number of *R. parkeri* genotypes per unit foliage have been isolated from trees within a 20-year-old managed stand and from an isolated tree than from old growth trees. Therefore, the variation of genetic diversity of *R. parkeri* populations is ascribed to differences in tree age and access to inoculum. Furthermore, the genotypes of an endophytic fungus *Discula umbrinella* are related to host origin on the basis of the analysis of 30 strains isolated from beech, chestnut, and oak assessed by RAPD markers (Hämmerli et al. 1992). The population structure of an endophytic fungus *Phialocephala fortinii* has been studied at a primary succession site on a glacier forefront using RAPD markers, and 23 genets of *P. fortinii* were detected in 34 strains in 1 year, and 10 genets were found in 49 strains in the next year, but none of

the genets was isolated in both years (Jumpponen 1999). Further studies show that there are recombination, gene, and genotype flow in *P. fortinii* population based on the analysis of single-locus RFLP markers (Grünig et al. 2003). In addition, all strains of endophytic *Phyllosticta* species isolated from different tropical tree species in India have been identified as species *Phyllosticta capitalensis* using ITS-RFLP markers (Pandey et al. 2003).

### 13.2.2 SSR and AFLP Techniques

SSR or ISSR technique, which is originally used to measure genetic diversity of plants and animals (Zietkiewicz et al. 1994), has been applied in studies of fungi (Hantula et al. 1996; Hantula and Müller 1997; Liang et al. 2005). In endophyte studies, Groppe et al. (1995) have analyzed the genetic diversity of an endophytic fungus *Epichloë typhina* isolated from tissues of *Bromus erectus* using a microsatellite-containing locus as molecular markers. Further, Groppe and Boller (1997) have developed specific primer pairs flanking a microsatellite-containing locus and successfully detected a rDNA fragment of endophytic *Epichloë* species from infected tissues of *B. erectus*, but no fragments were generated from total DNA isolated from uninfected plant material or unrelated fungi isolated from the same grass. Further studies have shown that there are high levels of polymorphism between *Neotyphodium* and *Epichloë* species and low levels of polymorphism within *Neotyphodium coenophialum* and *N. lolii* based on the analysis of polymorphic SSR markers, and these markers can be used to identify endophytic fungi *Neotyphodium* and *Epichloë* and to evaluate intraspecific population genetic diversity (De Jong et al. 2003).

Four different morphotypes of an endophytic fungus *Sphaeropsis sapinea* have been isolated from the natural and exotic *Pinus* spp. in the Southern Hemisphere (Burgess et al. 2001). Of these morphotypes, the putative I is found to be identical to *Botryosphaeria obtusa*, the other remaining three are clearly distinguished using polymorphic SSR markers. Endophytic fungi *P. fortinii* and type I of a nonsporulating mycelium, which have the same allozyme phenotype, were differentiated on the basis of ISSR analysis (Grünig et al. 2001). Furthermore, 21 genets were detected in 144 *P. fortinii* strains isolated from roots of Norway spruce (*Picea abies*) collected within a plot ( $3 \times 3 \text{ m}^2$ ) of a 40-year-old plantation using ISSR markers (Grünig et al. 2002). Further population genetic studies suggest that the endophytic fungus *P. fortinii* population has high genetic diversity and should be considered cryptic species in the same forest site and even in the same root fragment in Europe (Grünig et al. 2004, 2006, 2007, 2008).

The relationship between endophytic population genotypes and hosts, age, and geographic origin has been investigated on the basis of the SSR analysis. A high genetic diversity in an endophytic fungus *Alternaria alternata* population isolated from *Pinus tabulaeformis* in Beijing was detected and no relationship between genotypes of *A. alternata* and host tissue ages (Guo et al. 2004) was found. Similarly, the genotypes of an endophytic fungus *Guignardia mangiferae* do not

correspond either to the host or to the geographic origin (Rodrigues et al. 2004), and there is no host specificity for isolates of an endophytic fungus *Lasiodiplodia theobromae*, although there is very high gene flow between populations from different hosts based on the SSR analysis (Mohali et al. 2005).

AFLP markers were used to analyze the genetic polymorphism existing in two natural populations of an endophytic fungus *Epichloë festucae* in semiarid natural grasslands in western Spain, and most genetic variation detected was found to occur within populations, with only a moderate amount of genetic differentiation between populations, and nonrecombinant asexual reproduction predominated in both populations (García et al. 2002).

The SSR (or ISSR) technique is comparatively cheap, fast, and easy to perform. It is similar to RAPD analysis, but longer primers (ca. 18 nucleotides) are used and the conditions (e.g., annealing temperature) during amplification are more stringent. Furthermore, genomic regions containing microsatellites evolve and mutate more rapidly than other areas of genome. This is due to slipped-strand mispairing during replication, with the slippage rate depending on the length of the repeat (Levinson and Gutman 1987; Burgess et al. 2001). Therefore, the use of higher annealing temperatures and longer nucleotide primers results in highly reproducible SSR markers that are much more robust than the RAPD markers used previously (Roberts et al. 2000; Peever et al. 2002; Liang et al. 2005). The SSR markers are also more powerful than the RFLP profiles generated from rDNA in revealing genetic variation among a set of closely related isolates (Adachi et al. 1993; Aradhya et al. 2001). Thus, SSR (ISSR) technique combines most of the benefits of RAPD and microsatellite analyzes, and is ideal for studies of genetic variation of endophyte population.

There are arguments against using SSR (ISSR) techniques, as compared to AFLP and RAPD, in population genetic studies. Although microsatellite alleles are considered to be codominant markers, differences in alleles are measured solely on the basis of size. There is therefore the possibility of single-point mutations within the flanking sequence that do not result in a change in the fragment length. Furthermore, fragments from different genomic regions can co-migrate because they are of the same size. It is possible that different indels could result in fragments of the same size that have different sequences. In addition, markers may not be independent, because of genetic linkage or being alternative alleles at the same locus. In an asexual fungus, however, meiotic segregation of markers cannot occur, and although co-migration may occur, this does not negate the usefulness of this approach. Thus, a dominant marker system is suitable for assessing haploid, asexual populations without overestimating variation due to co-segregation (Bock et al. 2002).

### 13.2.3 DGGE Technique

The DGGE technique, which is capable of separating closely related sequences by their differential mobilities in a gradient of denaturants, has been effectively used to estimate the diversity of prokaryotes and eukaryotes in natural samples

(Díez et al. 2001; Dar et al. 2005; Countway et al. 2005; Jeewon and Hyde 2006). This technique has recently been successfully applied to document fungal communities (Kowalchuk et al. 1997; Vainio and Hantula 2000; May et al. 2001; Nikolcheva et al. 2003). In endophyte studies, Duong et al. (2006) used DGGE coupled with sequence analysis of partial 18S rRNA gene to assess endophytic fungal diversity in living leaves of *Magnolia liliifera* collected from Thailand. A total of 14 operational taxonomic units were recovered, and the DGGE could be used to detect known and abundant fungi (Xylariales, Hypocreales, and Pleosporales) as well as unknown endophytic fungi (Mycosphaerellales, Dothideales, Helotiales, and Rhytismatales). Similarly, the composition and relative abundance of endophytic fungi were assessed by DGGE analysis of 18S rRNA gene fragments amplified from total community DNA extracted from roots of potato *Solanum tuberosum* (Götz et al. 2006). Dominant bands in DGGE correspond to *Verticillium dahliae*, *Cylindrocarpon destructans*, and *Colletotrichum coccodes*, as the most frequently isolated species by traditional cultural method. Therefore, differences in the relative abundance of endophytic fungi colonizing the roots of T4-lysozyme producing potatoes and the parental line can be detected by DGGE methods.

DGGE is a suitable method that can be applied to estimate fungal diversity by excising and sequencing bands, thereby obtaining taxonomic information for members of the community via database searches and phylogenetic analysis (Anderson and Cairney 2004; Duong et al. 2006). Simultaneously, the techniques can be used in conjunction with DNA oligonucleotide probes to increase the specificity of the analysis (Stephen et al. 1998). Despite the advantages of DGGE, there are also disadvantages. In general, shorter fragments (<500 bp) of DNA result in better resolution between bands in a profile, thereby limiting the taxonomic information to properly identify taxa at the genus or species level (May et al. 2001; Duong et al. 2006), although some larger products have also been used successfully in a few cases (Ranjard et al. 2000). Moreover, even the most sensitive staining methods are often not sensitive enough to detect all the diversity present within a sample, particularly for the less dominant members of the fungal community (Anderson and Cairney 2004). In addition, in some cases single bands on a gel have been shown to comprise more than a single sequence type (Schmalenberger and Tebbe 2003). Further studies should consider primers that are more universal for fungi and give better phylogenetic resolution at generic or species level.

### 13.3 Molecular Sequencing for Endophytic Fungal Community

Molecular fingerprinting techniques are inadequate for the analysis of fungal communities from environmental samples where several different fungi may be simultaneously present and where their identities unknown. However, molecular sequencing techniques have been successfully employed for fungal identification and phylogenies based on the sequence analyses of coding genes, e.g., cytochrome *c* oxidase 1 (*COI*) gene, beta-tubulin 2 gene (*tub2*), and 18S, 28S and 5.8S genes of

rDNA and noncoding internal transcribed spacer (ITS) regions of rDNA. Because most coding genes are highly conserved, they have been successfully used to assess phylogenetic relationships at higher taxonomic levels. The *COI*, *tub2*, and ITS regions benefit from a fast rate of evolution, resulting in greater sequence variation between closely related species. These region sequences therefore generally provide greater lower taxonomic resolution at genus and species level. Molecular sequencing techniques have recently been successfully used in the detection and identification of endophytic fungi based on phylogenetic analysis and sequence similarity comparison.

### 13.3.1 Identification of Endophytic Fungi

The endophytic fungal community of roots of healthy conifers Douglas-fir (*Pseudotsuga menziesii*) and ponderosa pine (*Pinus ponderosa*) has been surveyed in the dry forests on the eastern slope of the Cascade Mountains in Washington, USA (Hoff et al. 2004). A total of 27 fungal genera were isolated and identified using a combination of morphological and molecular (ITS region sequences) methods. Fourteen genera were isolated from ponderosa pine, and nine genera from Douglas-fir. Most of the fungi isolated are ascomycetes and zygomycetes, and a few are basidiomycetes. Of these, endophytic fungi *Byssochlamys nivea*, *Umbelopsis* spp., and *Mucor* sp. are the most frequently recovered fungi from ponderosa pine and Douglas-fir. Similarly, a new endophytic fungus *Pestalotiopsis hainanensis* isolated from healthy branches of *Podocarpus macrophyllus* in tropical China was identified by a combination of morphological characteristics and ITS and *tub2* sequence analyses (Liu et al. 2007).

Based on ITS rDNA sequence similarity (95%) to operationally designate species boundaries, a total of 277 fungal species were recovered from 1,403 endophytic strains isolated from common plants in arctic, boreal, temperate, and tropical localities, which represent phylogenetically diverse plant taxa (Arnold and Lutzoni 2007). Similarly, a total of 439 isolates representing 24 morphotaxa were isolated from asymptomatic foliage of loblolly pine (*Pinus taeda*) in North Carolina, USA. Sequence data from ITS region for 150 isolates revealed 59 distinct ITS genotypes that represent 24 and 37 unique groups based on 90% and 95% sequence similarity, respectively (Arnold et al. 2007).

In some studies not only the ITS region but also 18S and 28S rDNA fragments have been employed in the identification of endophytic fungi at various taxonomic levels. Diversity of endophytic fungi isolated from bamboos *Phyllostachy* and *Sasa* species were studied based on the analyses of 18S rDNA gene and ITS region sequences, and 71 representative strains were placed into Sordariomycetes and Dothideomycetes. Of these, fungi Xylariales is the dominant group within bamboos and several rDNA gene sequences are not similar to any current sequence in the database and might be novel species or genera (Morakotkarn et al. 2007). Similarly, a total of 47 distinct genotype groups based on 90% ITS sequence similarity were



obtained from 280 representative strains isolated from healthy photosynthetic tissues of three plant species (*Huperzia selago*, *Picea mariana*, and *Dryas integrifolia*) in northern and southern boreal forests and arctic tundra (Higgins et al. 2007). Further phylogenetic analyses of combined data from 18S and 28S rDNA show that these different genotypic endophytic fungi represent Dothideomycetes, Sordariomycetes, Chaetothyriomycetidae, Leotiomycetes, and Pezizomycetes of Ascomycota.

### 13.3.2 Identification of Nonsporulating Endophytic Fungi

In traditional cultivation-dependent process of endophytic studies, endophytic isolates can be identified only on the basis of morphological characteristics if they sporulate on the media. Despite the development of various methods to promote sporulation, e.g., by growing them on modifications of artificial media and under various incubation conditions (Guo et al. 1998, 2000; Taylor et al. 1999), the number of isolates that do not sporulate ranges from 4.5–54% of the total isolates (Petrini et al. 1982, Espinosa-Garcia and Langenheim 1990; Johnson and Whitney 1992; Fisher et al. 1993; Guo et al. 2000, 2008; Photita et al. 2001; Cannon and Simmons 2002; Kumaresan and Suryanarayanan 2002; Wang and Guo 2007; Sun et al. 2008). Since conventional classification of fungi relies heavily on reproductive structures, these nonsporulating strains cannot be provided with taxonomic names. In order to appreciate the considerable diversity of these mycelia sterilia in culture, they are generally categorized as “morphotype” on the basis of similar cultural characters (Taylor et al. 1999; Guo et al. 2000, 2003; Arnold et al. 2001; Wang et al. 2005). Arrangement of taxa into different morphotypes, however, does not reflect species phylogeny, because morphotypes are not real taxonomic entities (Lacap et al. 2003; Guo et al. 2000; 2003; Wang et al. 2005). Molecular methods are therefore required for the identification and understanding of the diversity of these endophytic mycelia sterilia.

In our survey of endophytic fungi from fronds of *Livistona chinensis* in Hong Kong, a large number of isolates (16.5% of total isolates) do not sporulate, remaining as mycelia sterilia (Guo et al. 2000). These nonsporulating isolates were grouped into 19 morphotypes on the basis of their cultural morphology. Furthermore, nine morphotypes were identified to genus level (*Diaporthe*, *Mycosphaerella*, and *Xylaria*), five to family level (Pleosporaceae and Clypeosphaeriaceae), and the other five to ordinal level (Xylariales) on the basis of ITS sequence similarity comparisons and phylogenetic analyses. Similarly, in our another study of endophytic fungi of *P. tabulaeformis* in two distinct climatic sites of Liaoning province of China, a large number of isolates (11% of total isolates) remained as mycelia sterilia (Wang and Guo 2007). These nonsporulating isolates were grouped into 74 morphotypes according to their cultural morphology, and were further divided into 64 taxa on the basis of ITS sequence analyses. Of these morphotypes, five are Basidiomycota and 69 are Ascomycota, and then two morphotypes were identified as *Fusarium sporotrichioides* and *Schizophyllum commune*, respectively.



Twenty-two morphotypes were identified to generic level, seven to family (Lophiostomataceae and Valsaceae) level, and four to ordinal (Helotiales and Pezizales) level (Wang et al. 2005).

Fifty-nine of morphologically unidentifiable strains isolated from healthy stems and pods of cacao (*Theobroma cacao*) trees in natural forest ecosystems and agroecosystems in Latin America and West Africa were identified on the basis of the sequence analyses of 28S rDNA (Crozier et al. 2006). The majority of the isolates tested belong to Basidiomycota, particularly to corticoid and polyporoid taxa. Some isolates come from rarely isolated genera, such as *Byssomerulius*, whilst the most commonly isolated basidiomycetous endophyte is a member of the cosmopolitan genus *Coprinellus* of Agaricales.

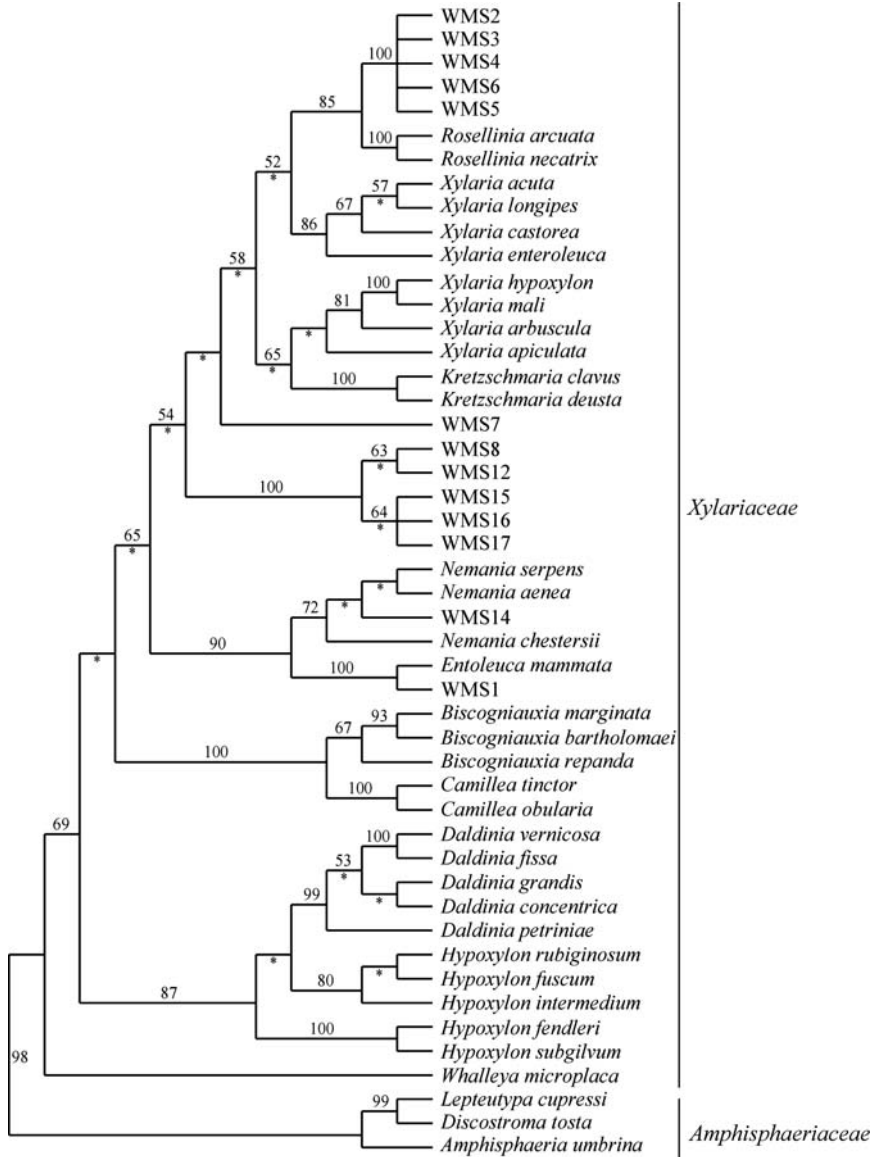
In our recent study of endophytic fungi of 20 lichen species in four sites of China, a total of 340 isolates (17.9% of total isolates) did not produce any spores and were divided into 51 morphotypes according to similar cultural characteristics. These morphotypes were placed into 42 taxa, including Atheliales and Agaricales of Basidiomycota and Coniochaetales, Hypocreales, Pezizales, Pleosporales, Sordariales, and Xylariales of Ascomycota on the basis of ITS sequence analyses (W.C. Li and L.D. Guo, unpublished data).

### ***13.3.3 Identification of White Morphotype Strains***

In our investigation of endophyte diversity from *P. tabulaeformis* at Dongling Mountain mixed woodland, the Beijing Forest Ecosystem Research Station of the Chinese Academy of Sciences in China (Guo et al. 2008), the sterile mycelia were divided into different morphotypes on the basis of similar cultural characteristics. Although some sterile isolates having similar cultural characters were grouped into the same morphotype, these isolates might be distantly related taxa. Therefore, an attempt was carried out to establish whether the isolates included in the same morphotype were of the same fungal origin. A total of 18 sterile strains grouped in the white morphotype were selected to evaluate the fungal origins of different isolates using ITS sequence analyses (Guo et al. 2003). Molecular identification showed that five strains belonged to species of Rhytismataceae, and the other 13 strains were identified to *Rosellinia*, *Entoleuca*, and *Nemania* of Xylariaceae (Fig. 13.1). Our results indicate that strains grouped into white morphotype have different fungal origins.

### ***13.3.4 Detection and Identification of Endophytic Fungi Within Plant Tissues***

Because of the limitations of traditional isolation techniques, it is highly probable that some or even numerous endophytic fungi are never isolated. This may be



**Fig. 13.1** One of 1,720 equally parsimonious trees generated from the ITS (ITS1, 5.8S and ITS2) sequences of 48 taxa showing the relationships of 13 white morphotype strains with reference taxa. The tree rooted with *Amphisphaeria umbrina*, *Discostroma tosta*, and *Lepteutypa cupressi* (Tree length = 1703, Consistency index = 0.437, Homoplasy index = 0.563, Retention index = 0.66, Rescaled consistency index = 0.289). Bootstrap values greater than or equal to 50% (1,000 replicates) are shown at branches. Asterisks indicate the branches that collapse in the strict consensus tree

because some endophytic fungi cannot grow on the artificial media. Most of the endophytic fungi isolated are also usually ascomycetes or their anamorphs. It is not clear whether this is because isolation techniques preclude other fungi, or whether only ascomycetes or their anamorphs constitute the endophytic fungal community. In order to overcome the potential technical bias, molecular techniques have been employed in the detection and identification of endophytic fungi including culturable and nonculturable fungi from the hosts. The molecular study generally includes five steps: (1) The total genomic DNA (including fungi and plants) is extracted from sterile plant tissues; (2) DNA fragments (e.g., ITS, 28S and 18S rDNA) are amplified from total DNA with fungal primers; (3) Polymerase chain reaction (PCR) products (bands) are separated by DGGE or are cloned into plasmids (e.g., *pGEM-T* vector); (4) Different single clones are screened using DNA fingerprinting techniques (e.g., RFLP and SSCP) and different DGGE bands are excised; (5) Representative clones and DGGE bands are sequenced and theoretically identified into various taxonomic levels on the basis of phylogenetic analysis and sequence similarity comparison.

Endophytic fungal community of Marram grass (*Ammophila arenaria*) roots were analyzed using DGGE with subsequent cloning and sequencing to identify the fungi by amplification of partial 18S rDNA gene (Kowalchuk et al. 1997). Some ITS fragments amplified from *Picea* foliages were identified as endophytic fungi isolated from the same plant tissues using a cultivation-dependent method (Camacho et al. 1997). In our study, fungal ITS regions were amplified directly from total genomic DNA extracted from fronds of *Livistona chinensis*. A total of five different cloned sequences of fungi were obtained; of these four cloned sequences were identified as *Glomerella* (anamorph *Colletotrichum*), *Mycosphaerella* (anamorph *Cladosporium*), and Herpotrichiellaceae of Ascomycetes, and the other one cloned sequence belonged to Basidiomycetes which is not found using traditional cultivation-dependent method (Guo et al. 2001). The variation in endophytic fungal diversity closely associated with roots, stems, and leaves of common reed (*Phragmites australis*) from two dry and two flooded sites at Lake Constance in Germany were investigated on the basis of ITS sequence analysis (Wirsal et al. 2001). Most isolates were Ascomycetes, and some were Basidiomycetes. The result indicates that there are differences in distribution of endophytic fungi between dry and flooded sites. Similarly, the differences in the composition and relative abundance of endophytic fungi colonizing the roots of T4-lysozyme producing potatoes and the parental line were detected by amplified 18S rRNA gene fragments from total community DNA extracted from roots of potato *Solanum tuberosum* (Götz et al. 2006).

In the detection of endophytic fungi of *Heterosmilax japonica* tissues, a broad spectrum of fungal ITS sequences was directly amplified from genomic DNA extracted from host tissues (Gao et al. 2005). Of these fungal sequences some were identified as *Aureobasidium*, *Botryosphaeria*, *Cladosporium*, *Glomerella*, *Mycosphaerella*, *Phomopsis*, and *Guignardia*, the others (e.g., YJ4-61, YJ4-9 and YJ4-70) were significantly similar to some uncultured environmental samples and were not specifically affiliated with any currently documented fungal sequences in

the NCBI GenBank database. Endophytic fungal rDNA fragments (28S and ITS) were amplified from surface sterilized needles from 12 *Pinus taeda* trees in North Carolina, USA (Arnold et al. 2007). Phylogenetic analyses of 28S rDNA indicate that cloned endophytic fungi are distributed across multiple lineages of Ascomycota and Basidiomycota. Further identification of cloned endophytic fungi based on ITS sequence analyses shows that there are at least four unique fungal species within Basidiomycota and at least nine fungal species within Ascomycota. Ascomycetous endophytic fungi are primarily Dothideomycetes and Leotiomyces, which are commonly isolated from *P. taeda* using traditional cultural methods, but no Sordariomycetes were recovered from cloned endophytic sequences, despite the prevalence of this lineage among cultural endophytes. The results of some previous studies show that the diversity of endophytic fungi detected with molecular methods differs from that found using traditional cultivation-dependent methods.

Although molecular techniques insight into diversity of endophytic fungi, there is disadvantage in the identification of endophyte morphotypes based on ITS sequence analysis. There is no criterion to delimit species boundary of ITS sequence divergence. This is because, although some endophytic fungi have high similarity in the ITS sequences and cluster together with high bootstrap support with reference taxa, there is still insufficient information at present to determine whether the terminal clades include one or more species in the phylogenetic analysis. For most of the taxa included in the DNA sequence analyses, the level of interspecific and intraspecific variations is still variable. Different levels of variations have been reported in the different taxa in previous studies. A relatively low substitution rate was reported in ITS sequences of several *Armillaria* species (0.5%) from the Northern Hemisphere (Anderson and Stasovski 1992) and among *Sclerotium* species (Carbone and Kohn 1993). On the contrary, there is a relatively low level of homology (76.1%) between weakly virulent and highly virulent isolates of *Leptosphaeria maculans*, while the ITS sequences differ in only four nucleotide positions within the highly virulent isolates and in two nucleotide positions within the weakly virulent isolates (Morales et al. 1993). Similarly, there is great divergence among three ITS types of *Fusarium sambucinum* (4.6–15%), while the divergence is extremely low (0–2.3%) within each type (O'Donnell 1992). Significantly, Arnold et al. (2007) have constructed well-supported phylogenies based on a ca. 600 bp of the 28S rDNA for 72 Ascomycota and Basidiomycota, 145 cultured endophytic fungi, and 33 environmental PCR samples. The result shows that ITS genotype groups based on 90% sequence similarity are concordant with 28S rDNA-delimited species. However, at present there appears to be absence of definite criteria for interspecific and intraspecific level of nucleotide divergence in ITS region sequences of fungi.

There are some limitations of the detection and identification of endophytic fungi directly from within plant tissues using molecular techniques. Firstly, as only sparse hyphae may exist within the plant tissues, some fungal DNA may be lost during the DNA extraction process, thus only a minor fraction of fungal DNA is included in the total DNA extracted from plant tissues. Secondly, there are

inhibitors that may interfere with the PCR amplification in the DNA solution. Thirdly, the universal primers may not completely match with some fungal template DNA. In addition, it is important to take into consideration that surface sterilization may not have denatured the DNA of epiphytes, although sodium hypochlorite is relatively effective for this purpose. Therefore, it is likely to be difficult to amplify all endophytic fungal DNA fragments from the total DNA samples.

Another limitation is the limited number of sequences, i.e., less than 1%, of the estimated 1.5 million fungal species presented in NCBI GenBank and EMBL database, although there is daily increase in fungal DNA sequences in public databases (Vilgalys 2003). In addition, misidentifications of named published sequences, of which ca. 20% of the named sequences may be attributed to incorrectly named organisms, may represent another problem restricting the feasibility of sequence-based identification of endophytic fungi (Vilgalys 2003; Hawksworth 2004).

## 13.4 Conclusions

Molecular fingerprinting techniques are powerful tools in the detection of population genetic structure and diversity of endophytic fungi. Further development of these markers to allow detection of endophytes in planta will considerably enhance their value, and will permit the sensitive detection of endophyte incidence in plant populations. Molecular sequencing techniques offer an effective method for the identification of endophytic fungi, particularly for nonsporulating isolates, and for the detection of the viable but nonculturable fungi by directly amplified rDNA fragments from plant tissues.

PCR-based molecular techniques are conventional PCR employed in the detection and identification of endophytic fungi in previous studies. These conventional PCR can identify endophytic fungi specifically, but it cannot be used to quantify endophytic fungal biomass within plant tissues. However, real-time PCR can detect small quantities of DNA in environmental samples and has been successfully used to determine the population density of some fungal species such as *Pyrenophora* sp. (Bates et al. 2001), *Plectosphaerella cucumerina* and *Paecilomyces lilacinus* (Atkins et al. 2003, 2004), and *Hirsutella rhossiliensis* (Zhang et al. 2006).

DNA barcoding systems employ a short, effective, standardized gene region to identify species (Hebert et al. 2003; Blaxter 2003; Savolainen et al. 2005; Seifert et al. 2007; Craig et al. 2008). To date, this technique has been extensively used in the animal kingdom with a 648-bp region of the *COI* gene (Smith et al. 2005; Ward et al. 2005; Hajibabaei et al. 2006). DNA barcodes were first employed in the identification of fungi *Penicillium* species using *COI* gene (Seifert et al. 2007) and ectomycorrhizal fungi in a Tasmanian wet sclerophyll forest by ITS regions (Tedersoo et al. 2008). With the improvement of molecular techniques, e.g., DNA fingerprinting, DNA sequencing, real-time PCR, and DNA barcoding, they will become routine, accurate, rapid, and sensitive techniques in the detection, identification, and quantification of endophytic fungal diversity in future.

## References

- Adachi Y, Watanabe H, Tababe K, Doke N, Nishimura S, Tsuge T (1993) Nuclear ribosomal DNA as a probe for genetic variability in the Japanese pear pathotype of *Alternaria alternata*. *Appl Environ Microbiol* 59:3197–3205
- Anderson IC, Cairney JWG (2004) Diversity and ecology of soil fungal communities: increased understanding through the application of molecular techniques. *Environ Microbiol* 6:769–779. doi:10.1111/j.1462-2920.2004.00675.x
- Anderson IC, Campbell CD, Prosser JI (2003) Diversity of fungi in organic soils under a moorland – Scots pine (*Pinus sylvestris* L.) gradient. *Environ Microbiol* 5:1121–1132. doi:10.1046/j.1462-2920.2003.00522.x
- Anderson JB, Stasovski E (1992) Molecular phylogeny of northern hemisphere species of *Armillaria*. *Mycologia* 84:505–516
- Aradhya MK, Chan HM, Parfitt DE (2001) Genetic variability in the pistachio late blight fungus, *Alternaria alternata*. *Mycol Res* 105:300–306. doi:10.1017/S0953756201003677
- Arnold AE, Lutzoni F (2007) Diversity and host range of foliar fungal endophytes: are tropical leaves biodiversity hotspots. *Ecology* 88:541–549. doi:10.1890/05-1459
- Arnold AE, Henk DA, Eells RL, Lutzoni F, Vilgalys R (2007) Diversity and phylogenetic affinities of foliar fungal endophytes in loblolly pine inferred by culturing and environmental PCR. *Mycologia* 99:185–206. doi:10.3852/mycologia.99.2.185
- Arnold AE, Maynard Z, Gilbert GS (2001) Fungal endophytes in dicotyledonous neotropical trees: patterns of abundance and diversity. *Mycol Res* 105:1502–1507. doi:10.1017/S0953756201004956
- Atkins SD, Clark IM, Pande S, Hirsch PR, Kerry BR (2004) The use of real-time PCR and species-specific primers for the identification and monitoring of *Paecilomyces lilacinus*. *FEMS Microbiol Ecol* 51:257–264. doi:10.1016/j.femsec.2004.09.002
- Atkins SD, Clark IM, Sosnowska D, Hirsch PR, Kerry BR (2003) Detection and quantification of *Plectosphaerella cucumerina*, a potential biological control agent of potato cyst nematodes, by using conventional PCR, real-time PCR, selective media and baiting. *Appl Environ Microbiol* 69:4788–4793. doi:10.1128/AEM.69.8.4788-4793.2003
- Bates JA, Taylor EJA, Kenyon DM, Thomas JE (2001) The application of real-time PCR to the identification, detection and quantification of *Pyrenophora* species in barley seed. *Mol Plant Pathol* 2:49–57. doi:10.1111/j.1364-3703.2001.00049.x
- Beck JJ, Ligon JM (1995) Polymerase chain reaction assays for the detection of *Stagonospora nodorum* and *Septoria tritici* in wheat. *Phytopathology* 85:319–324. doi:10.1094/Phyto-85-319
- Bills GF (1996) Isolation and analysis of endophytic fungal communities from wood plants. In: Redlin SC, Carris LM (eds) *Endophytic fungi in grasses and woody plants: systematics, ecology, and evolution*. APS Press, St. Paul, Minnesota, pp 31–65
- Blaxter M (2003) Counting angels with DNA. *Nature* 421:122–124. doi:10.1038/421122a
- Bock CH, Thrall PH, Brubaker CL, Burdon JJ (2002) Detection of genetic variation in *Alternaria brassicicola* using AFLP fingerprinting. *Mycol Res* 106:428–434. doi:10.1017/S0953756202005762
- Burgess T, Wingfield MJ, Wingfield BW (2001) Simple sequence repeat markers distinguish among morphotypes of *Sphaeropsis sapinea*. *Appl Environ Microbiol* 67:354–362. doi:10.1128/AEM.67.1.354-362.2001
- Camacho FJ, Gernandt DS, Liston A, Stone JK, Klein AS (1997) Endophytic fungal DNA, the source of contamination in spruce needle DNA. *Mol Ecol* 6:983–987. doi:10.1046/j.1365-294X.1997.00266.x
- Cannon PF, Simmons CM (2002) Diversity and host preference of leaf endophytic fungi in the Iwokrama Forest Reserve, Guyana. *Mycologia* 94:210–220
- Carbone I, Kohn LM (1993) Ribosomal DNA sequence divergence within internal transcribed spacer 1 of the Sclerotiniaceae. *Mycologia* 85:415–427

- Carroll GC (1986) The biology of endophytism in plants with particular reference to woody plants. In: Fokkema NJ, van den Heuvel J (eds) *Microbiology of the phyllosphere*. Cambridge University Press, Cambridge, U.K., pp 205–222
- Chambers SM, Sawyer NA, Cairney JWG (1999) Molecular identification of co-occurring *Cortinarius* and *Dermocybe* species from southeastern Australian sclerophyll forests. *Mycorrhiza* 9:85–90. doi:10.1007/s005720050004
- Chelius MK, Triplett EW (1999) Rapid detection of arbuscular mycorrhizae in roots and soil of an intensively managed turfgrass system by PCR amplification of small subunit rDNA. *Mycorrhiza* 9:61–64. doi:10.1007/s005720050264
- Clapp JP, Young JPW, Merryweather JW, Fitter AH (1995) Diversity of fungal symbionts arbuscular mycorrhizas from a natural community. *New phytol* 130:259–265. doi:10.1111/j.1469-8137.1995.tb03047.x
- Countway PD, Gast RJ, Savai P, Caron DA (2005) Protistan diversity estimates based on 18S rDNA from seawater incubations in the Western North Atlantic. *J Eukaryot Microbiol* 52:95–106. doi:10.1111/j.1550-7408.2005.05202006.x
- Craig DW, Pearson JV, Szelinger S, Sekar A, Redman M, Corneveaux JJ, Pawlowski TL, Laub T, Nunn G, Stephan DA, Homer N, Huentelman MJ (2008) Identification of genetic variants using bar-coded multiplexed sequencing. *Nat Methods* 5:887–893. doi:10.1038/nmeth.1251
- Crozier J, Thomas SE, Aime MC, Evans HC, Holmes KA (2006) Molecular characterization of fungal endophytic morphospecies isolated from stems and pods of *Theobroma cacao*. *Plant Pathol* 55:783–791. doi:10.1111/j.1365-3059.2006.01446.x
- Dar SA, Kuenen JG, Muyzer G (2005) Nested PCR-denaturing gradient gel electrophoresis approach to determine the diversity of sulfate-reducing bacteria in complex microbial communities. *Appl Environ Microbiol* 71:2325–2330. doi:10.1128/AEM.71.5.2325-2330.2005
- De Bary A (1866) *Morphologie und Physiologie der Pilze, Flechten, und Myxomyceten*. Hofmeister's handbook of physiological botany, Vol. 2. Leipzig
- De Jong EZ, Guthridge KM, Spangenberg GC, Forster JW (2003) Development and characterization of EST-derived simple sequence repeat (SSR) markers for pasture grass endophytes. *Genome* 46:277–290. doi:10.1139/g03-001
- Díez B, Pedrós-Alió C, Marsh TL, Massana R (2001) Application of denaturing gradient gel electrophoresis (DGGE) to study the diversity of marine Picoeukaryotic assemblages and comparison of DGGE with other molecular techniques. *Appl Environ Microbiol* 67:2942–2951. doi:10.1128/AEM.67.7.2942-2951.2001
- Duong LM, Jeewon R, Lumyong S, Hyde KD (2006) DGGE coupled with ribosomal DNA gene phylogenies reveal uncharacterized fungal phylotypes. *Fungal Divers* 23:121–138
- Espinosa-García FJ, Langenheim JH (1990) The leaf fungal endophytic community of a coastal redwood population diversity and spatial patterns. *New Phytol* 116:89–97. doi:10.1111/j.1469-8137.1990.tb00513.x
- Fisher PJ, Petrini O, Sutton BC (1993) A comparative study of fungal endophytes in leaves, xylem and bark of *Eucalyptus nitens* in Australia and England. *Sydowia* 45:338–345
- Gao XX, Zhou H, Xu DY, Yu CH, Chen YQ, Qu LH (2005) High diversity of endophytic fungi from the pharmaceutical plant, *Heterosmilax japonica* Kunth revealed by cultivation-independent approach. *FEMS Microbiol Lett* 249:255–266. doi:10.1016/j.femsle.2005.06.017
- García RA, Zapater JMM, Criado BG, Zabalgozcoa I (2002) Genetic structure of natural populations of the grass endophyte *Epichloë festucae* in semiarid grasslands. *Mol Ecol* 11:355–364. doi:10.1046/j.0962-1083.2001.01456.x
- Gardes M, White TJ, Fortin JA, Bruns TD, Taylor JW (1991) Identification of indigenous and introduced symbiotic fungi in ectomycorrhizae by amplification of nuclear and mitochondrial ribosomal DNA. *Can J Bot* 69:180–190. doi:10.1139/b91-026
- Götz M, Nirenberg H, Krause S, Wolters H, Draeger S, Buchner A, Lottmann J, Berg G, Smalla K (2006) Fungal endophytes in potato roots studied by traditional isolation and cultivation-independent DNA-based methods. *FEMS Microbiol Ecol* 58:404–413. doi:10.1111/j.1574-6941.2006.00169.x

- Groppe K, Boller T (1997) PCR assay based on a microsatellite-containing locus for detection and quantification of *Epichloë* endophytes in grass tissue. *Appl Environ Microbiol* 63:1543–1550
- Groppe K, Sanders I, Wiemken A, Boller T (1995) A microsatellite marker for studying the ecology and diversity of fungal endophytes (*Epichloë* spp.) in grasses. *Appl Environ Microbiol* 61:3943–3949
- Grünig CR, Brunner PC, Duò A, Sieber TN (2007) Suitability of methods for species recognition in the *Phialocephala fortinii*-*Acephala applanata* species complex using DNA analysis. *Fungal Genet Biol* 44:773–788. doi:10.1016/j.fgb.2006.12.008
- Grünig CR, Duò A, Sieber TN (2006) Population genetic analysis of *Phialocephala fortinii* s.l. and *Acephala applanata* in two undisturbed forests in Switzerland and evidence for new cryptic species. *Fungal Genet Biol* 43:410–421. doi:10.1016/j.fgb.2006.01.007
- Grünig CR, Duò A, Sieber TN, Holdenrieder O (2008) Assignment of species rank to six reproductively isolated cryptic species of the *Phialocephala fortinii* s.l.-*Acephala applanata* species complex. *Mycologia* 100:47–67. doi:10.3852/mycologia.100.1.47
- Grünig CR, Linde CC, Sieber TN, Rogers SO (2003) Development of single-copy RFLP markers for population genetic studies of *Phialocephala fortinii* and closely related taxa. *Mycol Res* 107:1332–1341. doi:10.1017/S0953756203008669
- Grünig CR, McDonald BA, Sieber TN, Rogers SO, Holdenrieder O (2004) Evidence for subdivision of the root-endophyte *Phialocephala fortinii* into cryptic species and recombination within species. *Fungal Genet Biol* 41:676–687. doi:10.1016/j.fgb.2004.03.004
- Grünig CR, Sieber TN, Holdenrieder O (2001) Characterisation of dark septate endophytic fungi (DSE) using inter-simple-sequence-repeat-anchored polymerase chain reaction (ISSR-PCR) amplification. *Mycol Res* 105:24–32. doi:10.1017/S0953756200003658
- Grünig CR, Sieber TN, Rogers SO, Holdenrieder O (2002) Spatial distribution of dark septate endophytes in a confined forest plot. *Mycol Res* 106:832–840. doi:10.1017/S0953756202005968
- Guo LD (2001) Advances of researches on endophytic fungi. *Mycosystema* 20:148–152
- Guo LD, Huang GR, Wang Y (2008) Seasonal and tissue age influences on endophytic fungi of *Pinus tabulaeformis* (Pinaceae) in Dongling Mountain, Beijing. *J Integr Plant Biol* 50:997–1003. doi:10.1111/j.1744-7909.2008.00394.x
- Guo LD, Huang GR, Wang Y, He WH, Zheng WH, Hyde KD (2003) Molecular identification of white morphotype strains of endophytic fungi from *Pinus tabulaeformis*. *Mycol Res* 107:680–688. doi:10.1017/S0953756203007834
- Guo LD, Hyde KD, Liew ECY (1998) A method to promote sporulation in palm endophytic fungi. *Fungal Divers* 1:109–113
- Guo LD, Hyde KD, Liew ECY (2000) Identification of endophytic fungi from *Livistona chinensis* (Palmae) using morphological and molecular techniques. *New Phytol* 147:617–630. doi:10.1046/j.1469-8137.2000.00716.x
- Guo LD, Hyde KD, Liew ECY (2001) Detection and identification of endophytic fungi within frond tissues of *Livistona chinensis* based on rDNA sequence. *Mol Phylogenet Evol* 20:1–13. doi:10.1006/mpev.2001.0942
- Guo LD, Xu L, Zheng WH, Hyde KD (2004) Genetic variation of *Alternaria alternata*, an endophytic fungus isolated from *Pinus tabulaeformis* as determined by random amplified microsatellites (RAMS). *Fungal Divers* 16:53–65
- Hajibabaei M, Janzen DH, Burns JM, Hallwachs W, Hebert PDN (2006) DNA barcodes distinguish species of tropical *Lepidoptera*. *PNAS* 103:968–971. doi:10.1073/pnas.0510466103
- Hämmerli UA, Brändle UE, Petrini O, McDermott JM (1992) Differentiation of isolates of *Discula umbrinella* (teleomorph: *Apiognomonia errabunda*) from beech, chestnut and oak using RAPD markers. *Mol Plant Microbe* 5:479–483. doi:10.1094/MPMI-5-479
- Hantula J, Müller MM (1997) Variation within *Cremmeniella abietina* in Finland and other countries as determined by random amplified microsatellites (RAMS). *Mycol Res* 101:169–175. doi:10.1017/S0953756296002225



- Hantula J, Dusabenyagasani M, Hamelin RC (1996) Random amplified microsatellites (RAMS) – a novel method for characterizing genetic variation within fungi. *Eur J Forest Pathol* 26:159–166. doi:10.1111/j.1439-0329.1996.tb00720.x
- Hawksworth DL (2004) ‘Misidentifications’ in fungal DNA sequence databanks. *New Phytol* 161:13–15. doi:10.1111/j.1469-8137.2004.00958.x
- Hawksworth DL (1991) The fungal dimension of biodiversity: magnitude, significance, and conservation. *Mycol Res* 95:641–655. doi:10.1016/S0953-7562(09)80810-1
- Hebert PDN, Cywinska A, Ball SL, de Waard JR (2003) Biological identifications through DNA barcodes. *Proc R Soc Lond B* 270:313–321. doi:10.1098/rspb.2002.2218
- Higgins KL, Arnold AE, Miadlikowska J, Sarvate SD, Lutzoni F (2007) Phylogenetic relationships, host affinity, and geographic structure of boreal and arctic endophytes from three major plant lineages. *Mol Phylogenet Evol* 42:543–555. doi:10.1016/j.ympev.2006.07.012
- Hoff JA, Klopfenstein NB, McDonald GI, Tonn JR, Kim MS, Zambino PJ, Hessburg PF, Rogers JD, Peever TL, Carris LM (2004) Fungal endophytes in woody roots of Douglas-fir (*Pseudotsuga menziesii*) and ponderosa pine (*Pinus ponderosa*). *Forest Pathol* 34:255–271. doi:10.1111/j.1439-0329.2004.00367.x
- Huai WX, Guo LD, He W (2003) Genetic diversity of an ectomycorrhizal fungus *Tricholoma terreum* in *Larix principis-rupprechtii* stand assessed using RAPDs. *Mycorrhiza* 13:265–270. doi:10.1007/s00572-003-0227-8
- Jansa J, Mozafar A, Kuhn G, Anken T, Ruh R, Sanders IR, Frossard E (2003) Soil tillage affects the community structure of mycorrhizal fungi in maize roots. *Ecol Appl* 13:1164–1176. doi:10.1890/1051-0761(2003)13[1164:STATCS]2.0.CO;2
- Jeewon R, Hyde KD (2006) Diversity and detection of fungi from environmental samples: traditional versus molecular approaches. In: Varma A, Oelmüller R (eds) *Advanced techniques in soil microbiology*. Soil Biology Series. Springer, Berlin, pp 1–15
- Johnson JA, Whitney NJ (1992) Isolation of fungal endophytes from black spruce (*Picea mariana*) dormant buds and needles from New Brunswick. *Can J Bot* 70:1754–1757. doi:10.1139/b92-217
- Jumpponen A (1999) Spatial distribution of discrete RAPD phenotypes of a root endophytic fungus, *Phialocephala fortinii*, at a primary successional site on a glacier forefront. *New Phytol* 141:333–344. doi:10.1046/j.1469-8137.1999.00344.x
- Klamer M, Roberts MS, Levine LH, Drake BG, Garland JL (2002) Influence of elevated CO<sub>2</sub> on the fungal community in a coastal scrub oak forest soil investigated with terminal restriction fragment length polymorphism analysis. *Appl Environ Microbiol* 68:4370–4376. doi:10.1128/AEM.68.9.4370-4376.2002
- Kowalchuk G, Gerards S, Woldendorp JW (1997) Detection and characterization of fungal infections of *Ammophila arenaria* (Marram grass) roots by denaturing gradient gel electrophoresis of specifically amplified 18S rDNA. *Appl Environ Microbiol* 63:3858–3865
- Kumaresan V, Suryanarayanan TS (2002) Endophytic assemblages in young, mature and senescent leaves of *Rhizophora apiculata*: evidence for the role of endophytes in mangrove litter degradation. *Fungal Divers* 9:91–91
- Lacap DC, Hyde KD, Liew ECY (2003) An evaluation of the fungal ‘morphotype’ concept based on ribosomal DNA sequences. *Fungal Divers* 12:53–66
- Levinson G, Gutman GA (1987) Slipped-strand mispairing: a major mechanism for DNA sequence evolution. *Mol Biol Evol* 4:203–221
- Li WC, Zhou J, Guo SY, Guo LD (2007) Endophytic fungi associated with lichens in Baihua mountain of Beijing, China. *Fungal Divers* 25:69–80
- Liang Y, Guo LD, Ma KP (2004) Genetic structure of a population of the ectomycorrhizal fungus *Russula vinosa* in subtropical woodlands in southwest China. *Mycorrhiza* 14:235–240. doi:10.1007/s00572-003-0260-7
- Liang Y, Guo LD, Ma KP (2005) Population genetic structure of an ectomycorrhizal fungus *Amanita manginiana* in a subtropical forest over 2 years. *Mycorrhiza* 15:137–142. doi:10.1007/s00572-004-0311-8

- Liu AR, Xu T, Guo LD (2007) Molecular and morphological description of *Pestalotiopsis hainanensis* sp. nov., a new endophyte from a tropical region of China. *Fungal Divers* 24:23–36
- Ma LJ, Catramis CM, Rogers SO, Starmer WT (1997) Isolation and characterisation of fungi entrapped in glacial ice. *Inoculum* 48:23–24
- May LA, Smiley B, Schmidt MG (2001) Comparative denaturing gradient gel electrophoresis analysis of fungal communities associated with whole plant corn silage. *Can J Microbiol* 47:829–841. doi:10.1139/cjm-47-9-829
- McCutcheon TL, Carroll GC (1993) Genotypic diversity in populations of a fungal endophyte from Douglas fir. *Mycologia* 85:180–186
- Mills PR, Sreenivasaprasad S, Brown AE (1992) Detection and differentiation of *Colletotrichum gloeosporioides* isolates using PCR. *FEMS Microbiol Lett* 98:137–144. doi:10.1111/j.1574-6968.1992.tb05503.x
- Mohali S, Burgess TI, Wingfield MJ (2005) Diversity and host association of the tropical tree endophyte *Lasiodiopodia theobromae* revealed using simple sequence repeat markers. *Forest Pathol* 35:385–396. doi:10.1111/j.1439-0329.2005.00418.x
- Morakotkarn D, Kawasaki H, Seki T (2007) Molecular diversity of bamboo-associated fungi isolated from Japan. *FEMS Microbiol Lett* 266:10–19. doi:10.1111/j.1574-6968.2006.00489.x
- Morales VM, Pelcher LE, Taylor JL (1993) Comparison of the 5.8 S rDNA and internal transcribed spacer sequences of isolates of *Leptosphaeria maculans* from different pathogenicity groups. *Curr Genet* 23:490–495. doi:10.1007/BF00312640
- Moukhamedov R, Hu X, Nazar RN, Robb J (1994) Use of polymerase chain reaction-amplified ribosomal intergenic sequences for the diagnosis of *Verticillium tricorpus*. *Phytopathology* 84:256–259. doi:10.1094/Phyto-84-256
- Nikolcheva LG, Cockshutt AM, Bärlocher F (2003) Determining diversity of freshwater fungi on decaying leaves: comparison of traditional and molecular approaches. *Appl Environ Microbiol* 69:2548–2554. doi:10.1128/AEM.69.5.2548-2554.2003
- O'Donnell K (1992) Ribosomal DNA internal transcribed spacers are highly divergent in the phytopathogenic ascomycete *Fusarium sambucinum* (*Gibberella pulicaris*). *Curr Genet* 22:213–220
- Pandey AK, Reddy MS, Suryanarayanan TS (2003) ITS-RFLP and ITS sequence analysis of a foliar endophytic *Phyllosticta* from different tropical trees. *Mycol Res* 107:439–444. doi:10.1017/S0953756203007494
- Peever TL, Ibañez A, Akimitsu K, Timmer LW (2002) Worldwide phylogeography of the citrus brown spot pathogen, *Alternaria alternata*. *Phytopathology* 92:794–802. doi:10.1094/PHYTO.2002.92.7.794
- Petrini O (1991) Fungal endophytes of tree leaves. In: Andrews JH, Hirano SS (eds) *Microbial ecology of leaves*. Springer-Verlag, New York, pp 179–197
- Petrini O, Stone J, Carroll FE (1982) Endophytic fungi in evergreen shrubs in western Oregon: a preliminary study. *Can J Bot* 60:789–796. doi:10.1139/b82-102
- Photita W, Lumyong S, Lumyong P, Hyde KD (2001) Endophytic fungi of wild banana (*Musa acuminata*) at doi Suthep Pui National Park, Thailand. *Mycol Res* 105:1508–1513. doi:10.1017/S0953756201004968
- Ranjard L, Poly F, Nazaret S (2000) Monitoring complex bacterial communities using culture-independent molecular techniques: application to soil environment. *Res Microbiol* 151:167–177. doi:10.1016/S0923-2508(00)00136-4
- Roberts RG, Reymond ST, Andersen B (2000) RAPD fragment pattern analysis and morphological segregation of small-spored *Alternaria* species and species groups. *Mycol Res* 104:151–160. doi:10.1017/S0953756299001690
- Rodrigues KF, Sieber TN, Grunig CR, Holdenrieder O (2004) Characterization of *Guignardia mangiferae* isolated from tropical plants based on morphology, ISSR-PCR amplifications and ITS1–5.8 S-ITS2 sequences. *Mycol Res* 108:45–52. doi:10.1017/S0953756203008840

- Rollo F, Sassaroli S, Ubaldi M (1995) Molecular phylogeny of the fungi of the Iceman's grass clothing. *Curr Genet* 28:289–297. doi:10.1007/BF00309789
- Savolainen V, Cowan RS, Vogler AP, Roderick GK, Lane R (2005) Towards writing the encyclopaedia of life: an introduction to DNA barcoding. *Phil Trans R Soc B* 360:1805–1811. doi:10.1098/rstb.2005.1730
- Schesser K, Luder A, Henson JM (1991) Use of polymerase chain reaction to detect the take-all fungus, *Gaeumannomyces graminis*, in infected wheat plants. *Appl Environ Microbiol* 57:553–556
- Schmalenberger A, Tebbe CC (2003) Bacterial diversity in maize rhizospheres: conclusions on the use of genetic profiles based on PCR-amplified partial small subunit rRNA genes in ecological studies. *Mol Ecol* 12:251–262. doi:10.1046/j.1365-294X.2003.01716.x
- Schulz B, Boyle C (2005) The endophytic continuum. *Mycol Res* 109:661–686. doi:10.1017/S095375620500273X
- Schulz B, Boyle C (2006) What are endophytes. In: Schul ZB, Boyle C, Sieber T (eds) *Microbial root endophytes*. Springer, Berlin, pp 1–13
- Seifert KA, Samson RA, de Waard JR, Houbraken J, Lévesque CA, Moncalvo JM, Louis-Seize G, Hebert PDN (2007) Prospects for fungus identification using CO1 DNA barcodes, with *Penicillium* as a test case. *PNAS* 104:3901–3906. doi:10.1073/pnas.0611691104
- Simon L, Lévesque RC, Lalonde M (1993) Identification of endomycorrhizal fungi colonizing roots by fluorescent single-strand conformation polymorphism-polymerase chain reaction. *Appl Environ Microbiol* 59:4211–4215
- Sinclair JB, Cerkaskas RF (1996) Latent infection vs. endophytic colonization by fungi. In: Redlin SC, Carris LM (eds) *Endophytic fungi in grasses and woody plants: systematics, ecology, and evolution*. Minnesota, APS Press, St. Paul, pp 3–29
- Smit E, Leeflang P, Glandorf B, van Elsland JD, Wernars K (1999) Analysis of fungal diversity in the wheat rhizosphere by sequencing of cloned PCR-amplified genes encoding 18S rRNA and temperature gradient gel electrophoresis. *Appl Environ Microbiol* 65:2614–2621
- Smith MA, Fisher BL, Hebert PDN (2005) DNA barcoding for effective biodiversity assessment of a hyperdiverse arthropod group: the ants of Madagascar. *Phil Trans R Soc B* 360:1825–1834. doi:10.1098/rstb.2005.1714
- Stephen JR, Kowalchuk GA, Bruns MAV, McCaig AE, Phillips CJ, Embley TM, Prosser JI (1998) Analysis of  $\beta$ -subgroup proteobacterial ammonia oxidizer populations in soil by denaturing gradient gel electrophoresis and hierarchical phylogenetic probing. *Appl Environ Microbiol* 64:2958–2965
- Stone JK, Bacon CW, White JF (2000) An overview of endophytic microbes: endophytism defined. In: Bacon CW, White JF (eds) *Microbial endophytes*. Marcel Dekker, New York, pp 3–30
- Sun JQ, Guo LD, Zang W, Ping WX, Chi DF (2008) Diversity and ecological distribution of endophytic fungi associated with medicinal plants. *Sci China Ser C Life Sci* 51:751–759
- Sun X, Guo LD (2007) Endophytic fungi VI. *Ciliophora quercus* sp. nov. from China. *Nova Hedwigia* 85:403–406. doi:10.1127/0029-5035/2007/0085-0403
- Taylor JE, Hyde KD, Jones EBG (1999) Endophytic fungi associated with the temperate palm, *Trachycarpus fortunei*, within and outside its natural geographic range. *New Phytol* 142:335–346. doi:10.1046/j.1469-8137.1999.00391.x
- Tedersoo L, Jairus T, Horton BM, Abarenkov K, Suvi T, Saar I, Kõljalg U (2008) Strong host preference of ectomycorrhizal fungi in a Tasmanian wet sclerophyll forest as revealed by DNA barcoding and taxon-specific primers. *New Phytol* 180:479–490. doi:10.1111/j.1469-8137.2008.02561.x
- Tooley PW, O'Neill NR, Goley ED, Carras MM (2000) Assessment of diversity in *Claviceps africana* and other *Claviceps* species by RAM and AFLP analyses. *Phytopathology* 90:1126–1130. doi:10.1094/PHYTO.2000.90.10.1126
- Vainio EJ, Hantula J (2000) Direct analysis of wood-inhabiting fungi using denaturing gradient gel electrophoresis. *Mycol Res* 104:927–930. doi:10.1017/S0953756200002471

- van Elsland JD, Duarte GF, Keijzer-Wolters A, Smit E (2000) Analysis of the dynamics of fungal communities in soil via fungal-specific PCR of soil DNA followed by denaturing gradient gel electrophoresis. *J Microbiol Methods* 43:133–151. doi:10.1016/S0167-7012(00)00212-8
- Vilgalys R (2003) Taxonomic misidentification in public DNA database. *New Phytol* 160:4–5. doi:10.1046/j.1469-8137.2003.00894.x
- Wang Y, Guo LD (2007) A comparative study of endophytic fungi in needles, bark, and xylem of *Pinus tabulaeformis*. *Can J Bot* 85:911–917. doi:10.1139/B07-084
- Wang Y, Guo LD, Hyde KD (2005) Taxonomic placement of sterile morphotypes of endophytic fungi from *Pinus tabulaeformis* (Pinaceae) in northeast China based on rDNA sequences. *Fungal Divers* 20:235–260
- Ward RD, Zemlak TS, Innes BH, Last PR, Hebert PDN (2005) DNA barcoding Australia's fish species. *Phil Trans R Soc B* 360:1847–1857. doi:10.1098/rstb.2005.1716
- Wei JG, Xu T, Guo LD, Liu AR, Zhang Y, Pan XH (2007) Endophytic *Pestalotiopsis* species associated with plants of Podocarpaceae, Theaceae and Taxaceae in southern China. *Fungal Divers* 24:55–74
- Wilson D (1995) Endophyte: the evolution of a term, and clarification of its use and definition. *Oikos* 73:274–276
- Wirsel SG, Liebinger W, Ernst M, Mendgen K (2001) Genetic diversity of fungi closely associated with common reed. *New Phytol* 149:589–598. doi:10.1046/j.1469-8137.2001.00038.x
- Zhang LM, Liu XZ, Zhu SF, Chen SY (2006) Detection of the nematophagous fungus *Hirsutella rhossiliensis* in soil by real-time PCR and parasitism bioassay. *Biol Control* 36:316–323. doi:10.1016/j.biocontrol.2005.08.002
- Zhang W, Wendel JF, Clark LG (1997) Bamboozled again! Inadvertent isolation of fungal rDNA sequences from bamboos (Poaceae: Bambusoideae). *Mol Phylogenet Evol* 8:205–217. doi:10.1006/mpev.1997.0422
- Zheng RY, Jiang H (1995) *Rhizomucor endophyticus* sp. nov., an endophytic zygomycetes from higher plants. *Mycotaxon* 56:455–466
- Zietkiewicz E, Rafalski A, Labuda D (1994) Genome fingerprinting by simple sequence repeat (SSR)-anchored polymerase chain reaction amplification. *Genomics* 20:176–183. doi:10.1006/geno.1994.1151

# Chapter 14

## Molecular Identification of Anaerobic Rumen Fungi

Martin Eckart, Katerina Fliegerová, Kerstin Hoffmann, and Kerstin Voigt

**Abstract** Anaerobic fungi are phylogenetically unique and form a separate group, the Neocallimastigomycota, among the chitinous fungi. Until now six genera are described within that phylum, namely the monocentric genera *Neocallimastix*, *Caecomycetes* and *Piromyces* as well as the polycentric genera *Anaeromyces*, *Cyllamyces* and *Orpinomyces*. This chapter gives a brief survey of the fascinating world of anaerobic rumen fungi, their phylogeny, and identification. The golden standards of molecular identification as well as promising alternatives will be discussed.

### 14.1 Introduction

The physiology of the microbial community is fundamental for understanding the processes of anaerobic decomposition of plant material, and has an economic relevance for mankind. The distribution of organisms within the rumen is essential for our understanding of the biochemistry of cellulose degradation (Hungate 1966). A major part of organisms within the rumen fluid encompasses bacteria and flagellates, but fresh and undigested plant material is rapidly colonised by anaerobic fungi. It is now generally known that the degradation of herbal carbohydrates by rumen fungi accelerates the digestion by downsizing the plant tissue particles. Those particles are subsequently more easily decomposed by bacteria and protozoa. The effectiveness of digestion is an important contributor to the health of animals in husbandry (Wulff 2001).

---

M. Eckart, K. Hoffmann, and K. Voigt

Institute of Microbiology, School of Biology and Pharmacy, University of Jena, Neugasse 25, 07743 Jena, Germany

e-mail: martin.eckart@uni-jena.de

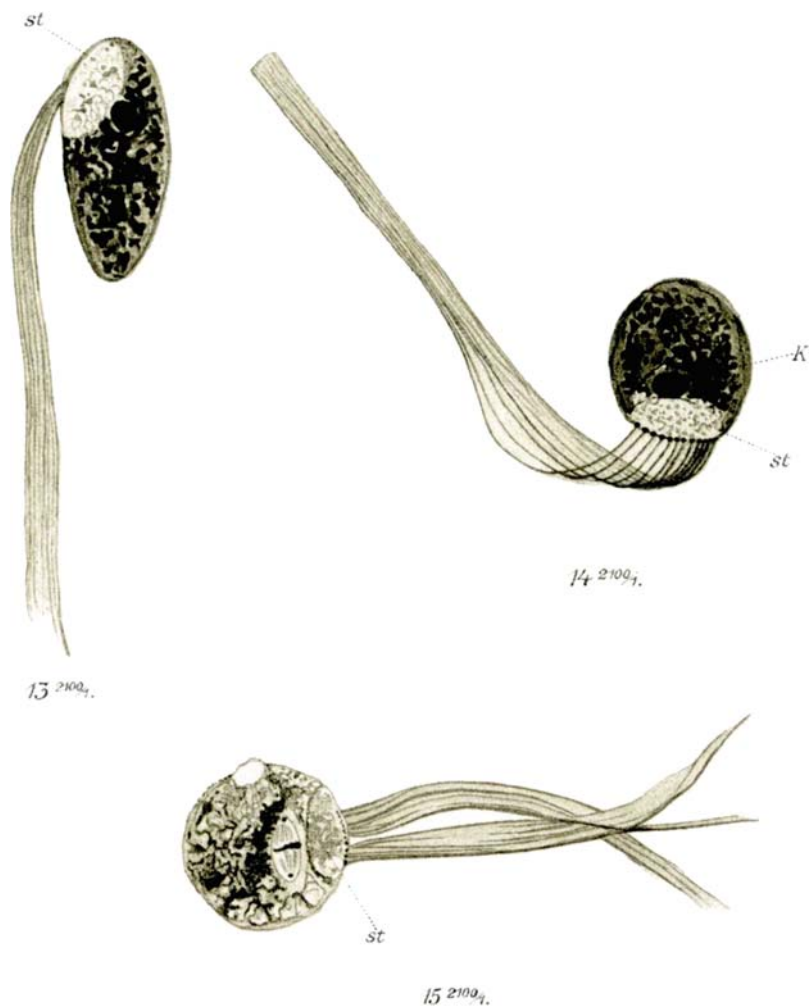
K. Fliegerová

Department of Biological Basis of Food Quality and Safety, Institute of Animal Physiology and Genetics, Czech Academy of Sciences, v.v.i., Vídeňská 1083, 14220 Prague 4, Czech Republic

Because of the economic and scientific interest in this topic, it is not surprising that the first description of “flagellated organisms” living within the rumen was given at the beginning of the twentieth century. But, astonishingly it needed more than 60 years to discover these organisms to be fungi living without any oxygen. The anaerobic environment is mandatory for the ecosystem rumen. It determines the mode of life of microorganisms residing there. Besides being well-known prokaryotes, anaerobic fungi are important producers of short-chain fatty acids, which are an essential source of nutrition for herbivores. Such a unique occupation of a special ecologic niche by a group of heterotrophic, hyphal, and chitin containing eukaryotes inevitably raises the question about the relationships of these fungi. Today, this group is well supported by morphological and molecular data and accepted as the Neocallimastigales (Li et al. 1993). Although the final position within the kingdom Fungi is still unclear, it turned out to be a monophyletic group, as a basal lineage besides or within the phylum Chytridiomycota, and is now recognised as phylum (James et al. 2006). While a flagellated phase through the life cycle of chytridiomycetes is a case *sui generis* proved for Chytridiales, Rhizophydiales, Spizellomycetales, Blastocladiales, and Neocallimastigales, the rumen fungi are characterised by another unique attribute inside the kingdom Fungi: they live in anaerobiosis. Until now, only several species of gut fungi have been described, probably because of the problematic cultivation and maintenance of these organisms and high morphological variability depending on growth conditions. Extensive studies of a broad range of ruminants and application of modern methods in molecular biology will probably bring deeper insights in microbial communities and species relationships. This survey gives a brief overview of the historical background and of modern trends in species recognition of this interesting fungal group.

## 14.2 Historical Background and the Discovery of Rumen Fungi

Decisive for the terminology of anaerobic gut fungi was a flagellated organism observed within the rumen of herbivores by Liebetanz (1910). This organism was named *Callimastix frontalis* (Braune 1913) because of its high morphological similarity to *Callimastix cyclopi*s (order Blastocladiales) (Weissenberg 1912), a flagellated parasite of *Cyclops*. Braune first described the multi-flagellated zoospores seen in Fig. 14.1, but did not recognise them as a stage of a fungal life cycle and misclassified this organism as parasite. The given name *C. frontalis* led to a number of mis-assignments of parasitic flagellates within this genus. Ultrastructural examinations of *C. frontalis* by Vavra and Joyón (1966) resulted in the establishment of the new genus *Neocallimastix*. But unfortunately, the authors did not recognise this organism as a fungus and still considered it as zooflagellate. Eight years later, Whisler et al. (1974) assumed that organisms of the genus *Neocallimastix* are actually motile spores of an alternate life cycle of *Coelomomyces psorophorae* – a blastocladial fungus – and declared the herbivores as



**Fig. 14.1** First description of *Callimastix* as a flagellate parasite. Front view, side view, and cleavage with aequitorial layer (Braune 1913)

alternative hosts along with mosquitoes. Orpin (1977) first suggested that these anaerobic organisms living in the rumen actually might be fungi and his assumption was based on the recognition of chitin in the cell walls and on the morphological description of the thallus of different *Neocallimastix* species (Orpin 1974, 1975, 1976). Orpin's findings were in contrast to the general belief of microbiologists that no obligate anaerobic fungi can exist and therefore fungal colonies growing in anoxic tubes were discarded as oxygen contaminations (van der Giezen 2002). However, none of these scientists provided a taxonomic definition for *Neocallimastix*. It was Heath et al. (1983) who linked *Neocallimastix* to the chytridiomycetes by setting up the new family Neocallimastigaceae within the

order Spizellomycetales (phylum Chytridiomycota). The lack of multiple morphological characters has always been and still is a handicap for identifying these organisms within the gut fungi.

### 14.3 Traditional and Current Systematics

Their incapability of locomotion and their appearance resulted in the erroneous classification of fungi as plants before the twentieth century. An own kingdom Fungi was recommended only in 1969 by Whittaker (1969). The Chytridiomycetes, besides the Oomycetes and Hyphochytriomycetes, were the only group of flagellated organisms that shared the class-characteristic cell-wall polymers (Bartnicki-Garcia 1970) and lysine synthetic pathway (Vogel 1964) of the Eumycota, comprising Zygo-, Asco- and Basidiomycetes at that time. In the 1980s, taxonomy and phylogeny of Chytridiomycetes were based on the thallus development, discharge of zoospores, the size, ultrastructural complexity, and organisation of zoospores, as well as number and length of flagella. Furthermore, characteristics like mono- and polycentric development as well as the release of zoospores via diffusion or via papillae affected the taxonomy and phylogeny of these basal fungi (Barr 1978).

The anaerobic gut fungi, as a special group of the flagellated fungi, often changed their taxonomic position within the Chytridiomycetes. Because of their late discovery and the unusual physiological character, especially the obligate anaerobiosis, the rumen fungi were placed into different taxonomic groups over time, first into the subdivision Mastigomycotina (Ainsworth 1966), and later into the division Mastigomycota (Alexopoulos and Mims 1979). Within the Mastigomycotina the following zoosporic fungi were accepted: Chytridiomycetes, Hyphochytridiomycetes, Plasmodiophoromycetes, and Oomycetes. The basis for this classification built the zoospore with one or two flagellae as an asexual propagative spore. The class Chytridiomycetes traditionally contained the four orders Chytridiales, Harpochytriales, Blastocladiales, and Monoblepharidales. Some studies mentioned the order Harpochytriales, now known as a synonym of the group Chytridiales (Kirk et al. 2008). Development of molecular genetic methods such as polymerase chain reaction (PCR), cloning, and automated sequencing enabled to generate data for diverse analyses. Traditional phylogeny based on the short-handed phenotypic markers such as morphology, physiology, and biochemistry is now complemented by statistically supported evolutionary analyses, which allowed re-evaluation and re-classification of the whole kingdom Fungi including also the young taxonomic group covering anaerobic fungi. Molecular-biological analysis of gut fungi performed by Li et al. (1993) resulted in the establishment of an own order, the Neocallimastigales, with only one family: Neocallimastigaceae. Recently, Hibbett et al. (2007) postulated a separate phylum for this group, the Neocallimastigomycota, adapted from the paraphyletic origin of the chytridiomycete fungi concluded by James et al. (2006). An informal supertree based on several analyses showed a close relationship to the chytridiomycetes (Hibbett et al. 2007).



**Table 14.1** The systematics of the chytridiomycetes based on traditional and modern classification schemes

Traditional system	Modern system
domain Eukaryota	domain Eukaryota
kingdom Fungi (Linnaeus 1753) Nees 1817	kingdom Fungi (Linnaeus 1753) Nees 1817
phylum Chytridiomycota von Arx 1967	phylum Chytridiomycota von Arx 1967
class Chytridiomycetes (de Bary 1863) Sparrow 1958	class Chytridiomycetes (de Bary 1863) Sparrow 1958
order Chytridiales Cohn 1879	order Chytridiales Cohn 1879
order Spizellomycetales Barr 1980	order Spizellomycetales Barr 1980
order Blastocladales Fitzpatrick 1930	order Rhizophydiales Letcher 2006
order Monoblepharidales Sparrow 1942	order Neocallimastigales Li et al. 1993
	class Monoblepharidomycetes Powell 2007
	order Monoblepharidales Sparrow 1942
	phylum Neocallimastigomycota Powell 2007
	class Neocallimastigomycetes Powell 2007
	order Neocallimastigales Li et al. 1993
	phylum Blastocladiomycota James et al. 2006
	class Blastocladiomycetes James et al. 2006
	order Blastocladales Fitzpatrick 1930

However, new phylogenetic approaches display the chytridiomycetes again as monophyletic group (Ebersberger et al. 2010). Therefore, the separate phylum Neocallimastigomycota seems to be redundant. A comparison of both classical taxonomy, based on morphology and physiology, and modern systematic methods, based on up-to-date molecular-genetic techniques, is shown in Table 14.1.

At present, the family Neocallimastigaceae comprises six genera<sup>1</sup> (Adl et al. 2005): *Anaeromyces* (Breton et al. 1990), *Caecomyces* (Gold et al. 1988), *Cyllamyces* (Ozkose et al. 2001), *Neocallimastix* (Vavra and Joyon ex Heath 1983), *Orpinomyces* (Barr et al. 1989), and *Piromyces* (Gold et al. 1988). An overview of the six taxonomic groups within the family Neocallimastigaceae is shown in Table 14.2.

## 14.4 Phylogeny

Traditional phylogenetic results supported by molecular-genetic data can redraw evolutionary hypothesis and consequently the affinity of organisms to taxonomic groups. Like phenotypic characterisations, molecular phylogenetics should never be based just on one character. Comparisons or combinations of morphological and genetic characters lead to stable and well supported evolutionary hypotheses and with this strengths and weaknesses of genetic markers become obvious. A marker of high diagnostic value has to be unique to a species or even to a strain and at the

<sup>1</sup><http://indexfungorum.org/Names/familyrecord.asp?strRecordID=81063>

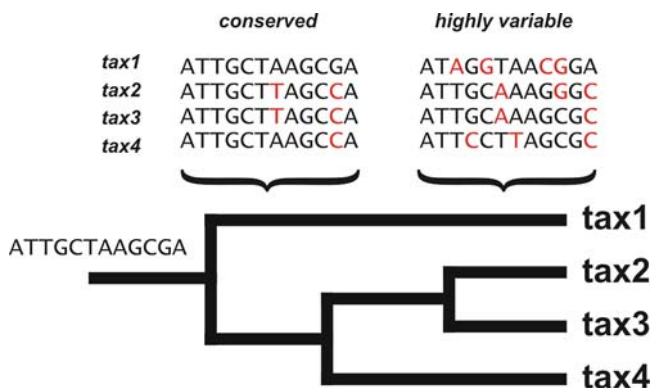
**Table 14.2** Survey of the species from the anaerobic chytrids

Genus	Species	Author
<i>Neocallimastix</i>	<i>frontalis</i>	(RA Braune) Vavra and Joyón 1966 ex IB Heath et al. (1983)
	<i>hurleyensis</i>	Theodorou and Webb (1991)
	<i>joyonii</i>	Breton, Gaillard, Bernalier, Bonnemoy and Fonty (1988)
	<i>patriciarum</i>	Orpin and Munn (1986)
<i>Anaeromyces</i>	<i>variabilis</i>	Ho and Barr (1993)
	<i>elegans</i>	Ho (1993)
<i>Caecomycetes</i>	<i>mucronatus</i>	Breton et al. (1990)
	<i>communis</i>	Gold et al. (1988)
	<i>equi</i>	Gold (1988)
<i>Cyllumyces</i>	<i>sympodialis</i>	Chen, Tsai and Chien (2007)
	<i>aberensis</i>	Ozkose et al. (2001)
<i>Orpinomyces</i>	<i>bovis</i>	Barr et al. (1989)
	<i>intercalaris</i>	Ho et al. (1994)
	<i>joyonii</i> <sup>1</sup>	(Breton, Bernalier, Bonnemoy, Fonty, Gaillard and Gouet) Li, Heath and Cheng (1990)
<i>Piromyces</i>	<i>citronii</i>	Gaillard, Breton, Dusser and Julliard (1995)
	<i>communis</i>	Gold, Heath, and Bauchop (1988)
	<i>dumbonicus</i>	Li (1990)
	<i>mae</i>	Li (1990)
	<i>minutus</i>	Ho (1993)
	<i>polycephalus</i>	Chen, Chien and Hseu (2002)
	<i>rhizinflatus</i>	Breton, Dusser, Gaillard, Guillot, Millet and Prensier (1991)
<i>spiralis</i>	Ho (1993)	

<sup>1</sup>Basionym, current name: *Neocallimastix joyonii* Breton, Bernalier, Bonnemoy, Fonty, B. Gaillard & Gouet 1989

same time ubiquitous for all taxa. The more various the set taxonomic groups is, the more conserved the marker has to be. On the other hand, clustering on lower level, starting with the family, requires more variable data to distinguish between species or even strains (outlined in Fig. 14.2).

Clustering methods use differences between partitions of given data to rebuild cladistic relationships. To get quality estimation such as bootstrap proportions (BTs or BP), checking the robustness of a set of data (Felsenstein 1985) is required. Highly conserved data lead to stable reconstructions in early branches caused by low clade stability supports. An example is given in Fig. 14.2. There is no possibility to distinguish between *taxon2* and *taxon3* based on identical sequence data. This exemplary marker is not adequate for molecular diagnostics on a lower taxonomic level such as genus or species. We demonstrate these problems with an analysis based on real data in Fig. 14.3. The gene encoding actin is highly conserved in eukaryotes. The coding sequence divergence between plant and non-plant actin genes shows only 15% or less variability (Hightower and Meagher 1986). Therefore, this marker demonstrates perfectly the relationship between anaerobic and aerobic chytridiomycetes, with the zygomycetous order Mucorales as outgroup (Fig. 14.3). Varieties of species level cannot be determined with actin data, as this marker lacks molecular diagnostics possibilities.

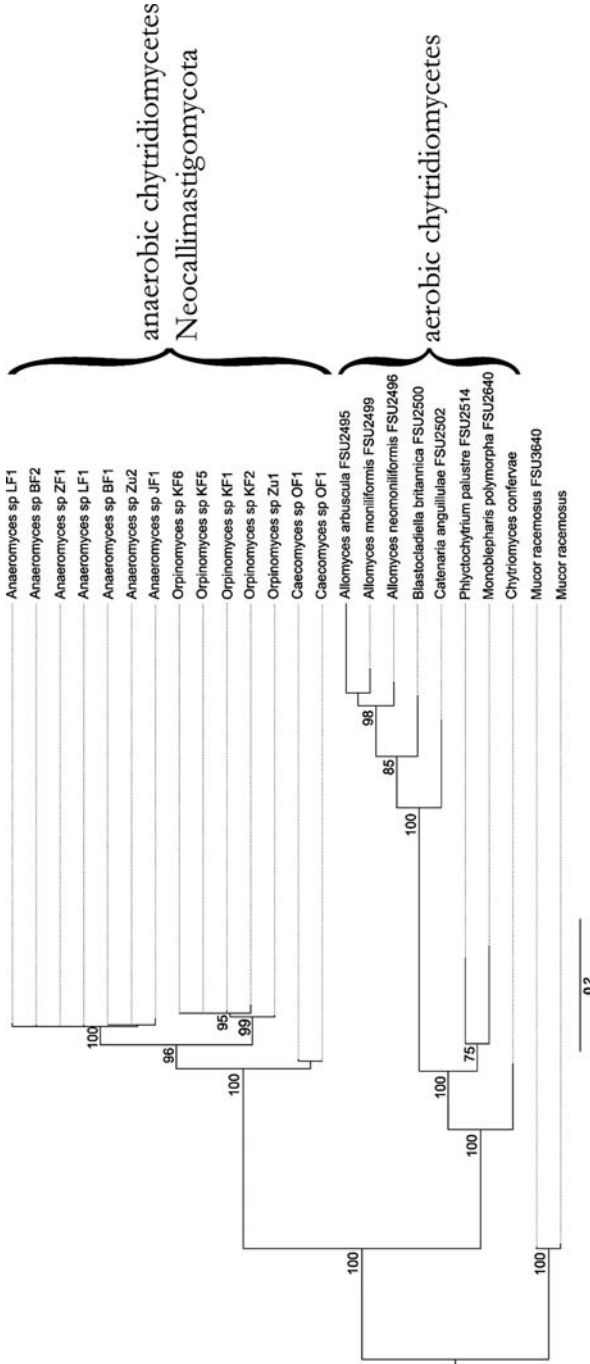


**Fig. 14.2** Schematic illustration of problems occurring during the application of single phylogenetic markers. The master sequence should be ATTGCTAAGCGA; the (recent) taxa show modified sequences. Changes compared to the consensus sequences are colour-coded in red. Occurring problems are obvious: a stable backbone with statistical support is only possible with data that are not highly diverse. However, differentiation at higher branches requires variable sequences. To combine these datasets, several approaches like supermatrix or supertree methods can be applied

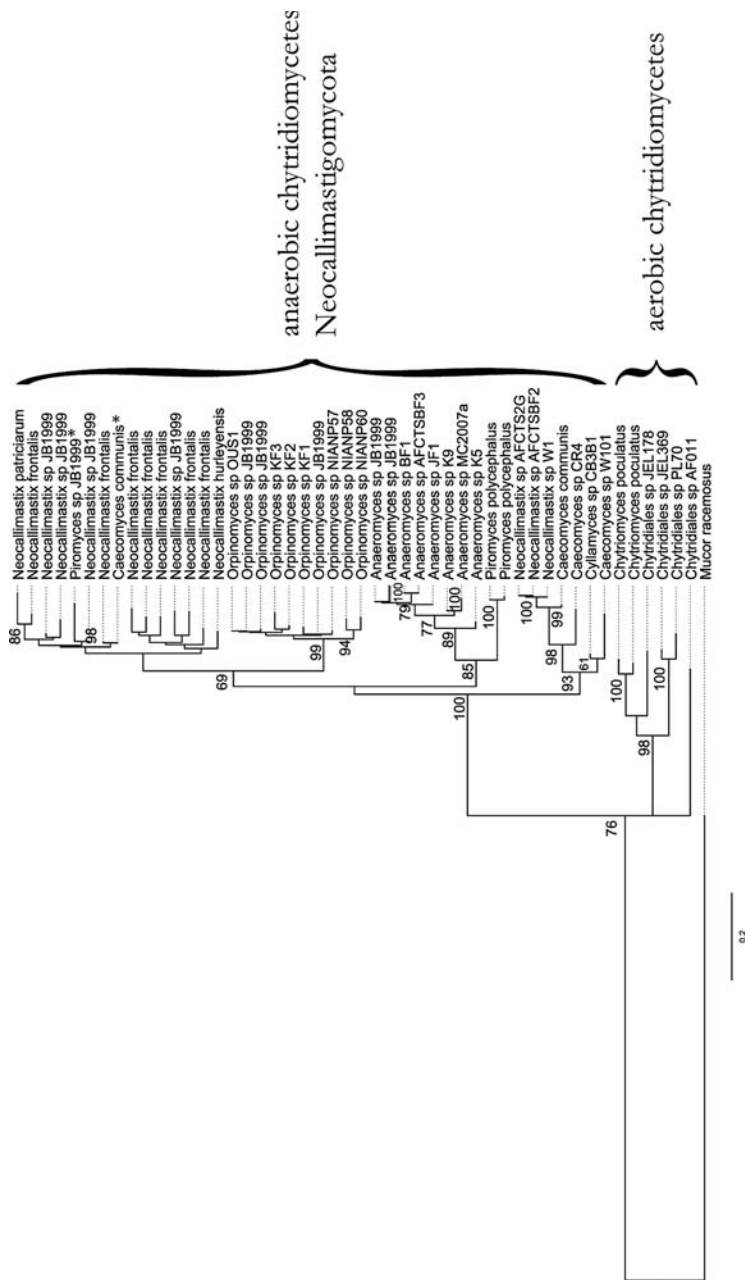
Nevertheless, highly variable data could result in an unstable reconstruction of early branches caused by “long-branch-attraction” (Bergsten 2005). Although high variable data could help measure distances between the closest neighbours and other taxa on lower taxonomic levels, the variability of the data could lead to false positive congruence, such as analogy instead of homology. An example is shown in Fig. 14.4. The high variability of the internal transcribed spacer (ITS) sequences of chytridiomycetes allow to distinguish even between strains, but alternative ways to cluster these data decrease the robustness of the data set. One problem is the differentiation of homologous and paralogous markers. Homology is not a problem if orthologous genes are involved, but paralogous genes can lead to misinterpreted results, similar to the comparison of “apples and oranges”. One example would be the eukaryotic translation elongation factor 1- $\alpha$  (EF-1 $\alpha$ ) with more than one copy within the genomes of fungi (see fungal genomes published by the JGI at <http://genome.jgi-psf.org/>). False positive results in phylogenetic analysis based on alignments of paralogous genes are not always obvious as shown in Fig. 14.5.

## 14.5 Predicted Impact of Molecular Markers on Future Identification and Phylogeny

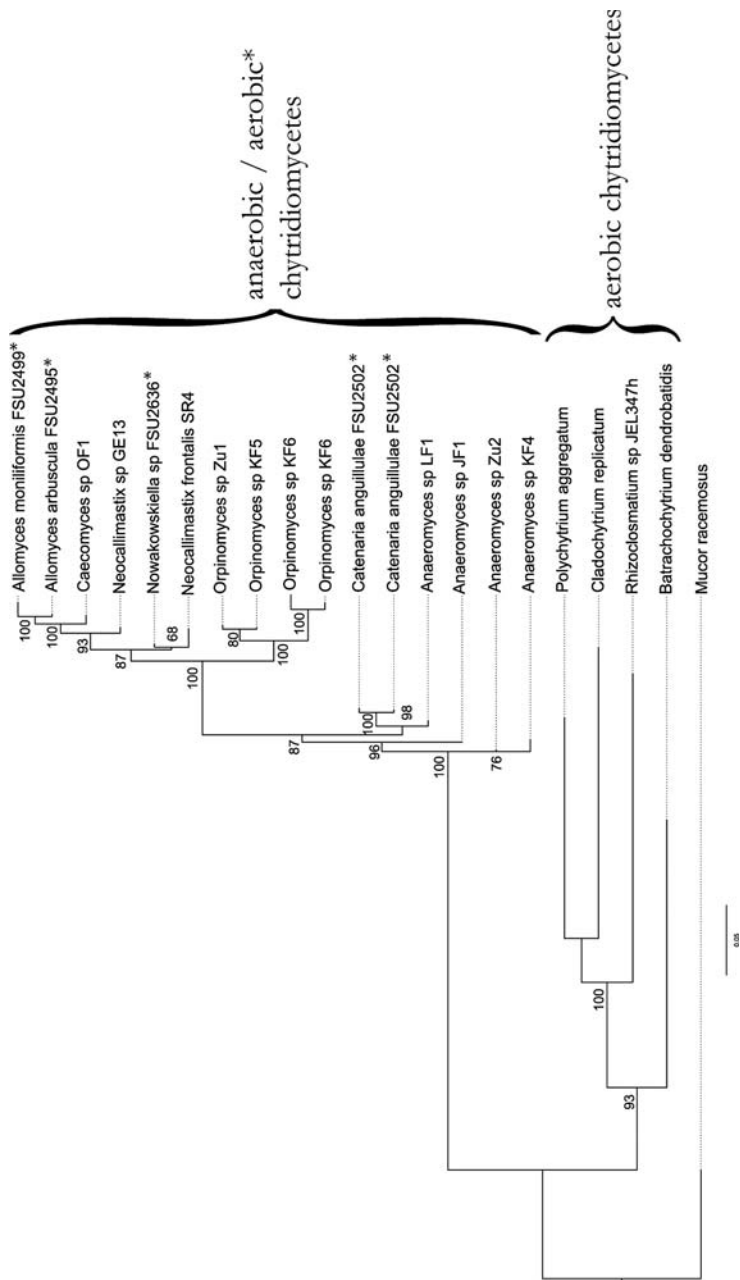
Based on the theory of evolution, highly conserved genes of diverse taxonomic groups could be amplified by the combination of PCR techniques and universal oligonucleotides (primers). The most commonly used DNA region for molecular-genetic phylogeny is the highly repetitive cluster of the nuclear ribosomal DNA (rDNA). The nucleotide sequences of the nuclear small (SSU) and large (LSU)



**Fig. 14.3** Phylogeny of the Neocallimastigomycota and other chytridiomycetes based on a Maximum Likelihood analysis of actin sequences from 24 taxa with a total of 903 aligned characters (unpublished sequences), (methodical informations: GAMMA + P-Invar model with RAxML 7.0.4 GTR-CAT (rapid hill-climbing bootstrapping method (Stamatakis 2006, 2008)), 10,000 rapid bootstrap inferences before a thorough ML search; final ML Optimization Likelihood: - 4676.139464)



**Fig. 14.4** Phylogeny of the Neocallimastigomycota and other chytridiomycetes based on a Maximum Likelihood analysis of ITS sequences from 49 taxa with a total of 1,161 aligned characters (unpublished sequences). (methodical informations: GAMMA + P-Invar model with RAxML 7.0.4 GTR-CAT, (Stamatakis 2006, 2008), 10,000 rapid bootstrap inferences before a thorough ML search. Final ML Optimization Likelihood: - 17766.020153)



**Fig. 14.5** Phylogeny of the Neocallimastigomycota and other chytridiomycetes based on a Maximum Likelihood analysis of tef sequences from 21 taxa with a total of 1,377 aligned characters (unpublished sequences). Included paralogous copies disturb the correct species assignments. (methodical informations: GAMMA + P-Invar model with RAXML 7.0.4 GTR-CAT (Stamatakis 2006, 2008), 10,000 rapid bootstrap inferences before a thorough ML search. Final ML Optimization Likelihood: - 5723.672908)

subunits are separated by the non-coding DNA sequences of the internal transcribed spacer (ITS) 1 and 2 and the non-transcribed intergenic spacer (IGS). Lacking a sufficient evolutionary pressure, the non-coding regions allow the separation of organisms down to the levels of species and strains. Using the flanking conserved sequences of 18S (SSU) and 28S (LSU) rDNA, these regions can easily be amplified with universal primers. Unfortunately, the ITS regions are not single copy regions. Although the ribosomal DNA cluster follows concerted evolution (Arnheim 1983), the intra-specific variability among organisms cannot be denied. Usage of this region as molecular barcode marker is therefore questionable, especially if there is no reliable and supporting approach for species identification based on e.g. morphology (Nilsson et al. 2008). Moreover, the variability of the ITS region is sometimes not high enough to separate at the level of species as shown for the fungal genus *Penicillium* (Skouboe et al. 1996, 1999). This experience enforced the search and establishment of alternative genetic markers like the intron-containing protein coding genes actin (*act*), eukaryotic translation elongation factor 1- $\alpha$  (*tef*), or beta-tubulin (*btub*). A profound base for this approach requires reference strains, which need to be morphologically and genetically well characterised, and also the subsequent completion of the published results and sequence submissions.

First efforts to identify the anaerobic gut fungi by molecular genetic methods were done by Doré and Stahl (1991) and Bowman et al. (1992). Their approaches relied on partial 18S rDNA sequences for including the anaerobic fungi into the chytridiomycetes, but the authors did not separate the species within the genera (Doré and Stahl 1991; Bowman et al. 1992).

Trying to clarify the phylogenetic relationships within the order Neocallimastigales using sequence analysis (ITS1) combined with morphological features, ultrastructures and mitotic characters have led to separation of the order Neocallimastigales (Li et al. 1993). Isozyme analyses or DNA hybridisation has also been used with the aim to clarify identification of anaerobic gut fungi and to increase the level of specificity (Ho et al. 1994).

A fast and easy method for the differentiation of polycentric anaerobic fungi is available by (RFLP) analysis of ITS spacer and/or fragments of ribosomal large subunit (28S rDNA) digested by proper endonucleases. However, the ribosomal small subunit (18S rDNA) turned out to be too conservative to get a well resolved DNA polymorphism, and therefore is not very suitable for this type of analysis (Fliegerová et al. 2006).

Methods of molecular biology are very promising, but “old-fashioned” taxonomy is still substantiated despite many discrepancies. The classical approach of Neocallimastigales identification is based on their morphological characters. Thal-*lus* shape (filamentous or bulbous), zoosporangial development (monocentric or polycentric), and number of flagella per zoospore (uni- or polyflagellated) are decisive for genus differentiations, while the ultrastructure of the zoospore is determinative for species. (Heath et al. 1983; Orpin and Munn 1986; Munn et al. 1988; Webb and Theodorou 1991). Unfortunately, characters observable by light microscopy vary with culture conditions and are highly pleomorphic (Brookman et al. 2000). Moreover, the cultures often fail to produce important structures

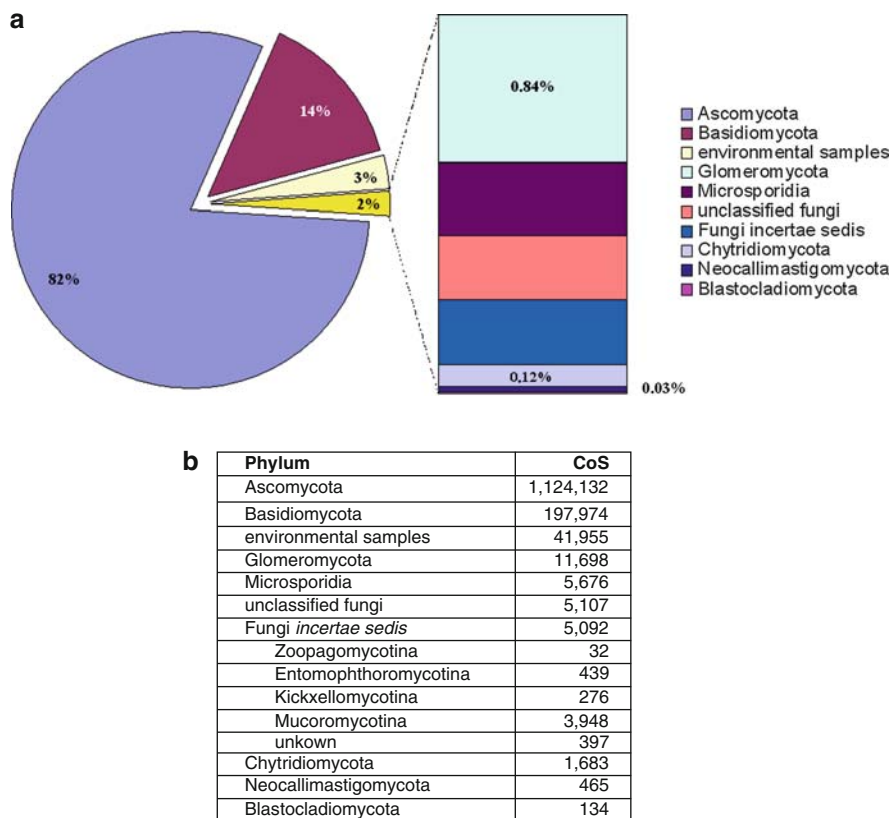
(sporangia and zoospores) making identification even more problematic. Also the differentiation of species using ultrastructural features of the zoospores is questionable, because ultrastructure depends not only on the age of microorganisms but also on the method and quality of their preparation (Ho and Barr 1995).

## 14.6 Molecular Identification and DNA Barcoding

One of the important characteristics of anaerobic fungi is their flagellated stage in life cycle. However, flagellated zoospores, can be found also in other aquatic fungi, like the Blastocladiomycota and the Chytridiomycota *sensu stricto* and also in some protists, e.g., the stramenopiles and among those the oomycetes, which are derived brown algae. The flagellae of these organisms caused the mis-applications of taxonomic and phylogenetic assignments as it happened to Braune with *Neocallimastix* (1913). The elucidation of morphological characters is valuable and indispensable, but has to be supported by techniques of molecular genetics because the pleomorphic shape of fungi leads to complications in their identification. Therefore, molecular information becomes more and more important as a primary source for species recognition. Now, 90 years after the discovery of the anaerobic rumen fungi, molecular phylogenetic studies confirmed their relationship to the kingdom Fungi (Förster et al. 1990; Bowman et al. 1992). The choice of molecular genetic markers in the kingdom Fungi, respectively the phylum Chytridiomycota, is clearly arranged. Today, state of the art comprises seven markers for fungal phylogeny that provides data over the complete spectrum of the kingdom: 18S rDNA, 28S rDNA, ITS1 and ITS2 including the 5.8S rDNA, rpb1, rpb2, tef, and beta-tubulin. In special cases like pathogenic species or organisms of industrial importance, some additional markers exhibiting a higher specificity were developed. Such markers encompass not only genes encoding calmodulin, Mcm7 (MS456), and Tsr1 (MS277) (Aguileta et al. 2008; Schmitt et al. 2009) but also physiological properties such as toxins or extrolite profiles, which are well established, for example, the ascomycetous genus *Penicillium* (Samson and Frisvad 2004).

To find the most useful marker for “tagging” all forms of life is the aim of many current projects involved in “DNA barcoding”. DNA barcoding is an approach to identify any organism based on sequence analysis of selected genomic regions. Access to these regions should be as universal as possible, comparable, reproducible, and relatively easy to accomplish. Barcoding is thought to serve not only the identification or verification of known specimens but also to contribute in the discovery of new, undescribed species. Although DNA barcoding already proved to be a very useful tool for the discovery of cryptic species, which are by definition not differentiable by morphological features (Hebert et al. 2004), barcoding is nevertheless error-prone. Depending on the method used, DNA barcoding turned out to be not always sufficient for species recognition (Brower 2006; DeSalle et al. 2005; Whitworth et al. 2007). One of the major problems in all barcoding





**Fig. 14.6** Schematic illustration and number of nucleotide sequences provided by the International Nucleotide Sequence Database Collaboration. (e.g., Genbank). **(a)** Percentages of the number of fungal sequences provided in GenBank. The graph shows the total number of submitted sequences within the kingdom Fungi. The subparts describe the single phyla based on the taxonomy provided by the TaxBrowser at NCBI. The group Dikarya is represented by approximately 96% of all available sequences. The number of sequences that were generated of environmental samples is higher than that of all other phyla with the exception of the Dikarya. The Neocallimastigomycota represent with 465 sequences the second smallest group of fungal organisms represented as nucleotide sequences within GenBank. **(b)** Survey of the nucleotide sequences provided by the International Nucleotide Sequence Database Collaboration (as of May 1st, 2009)

approaches is still the question which molecular tool should be used, since every further step in species identification is based on it.

In animal systems, the mitochondrial *cox1* is widely applied (Hebert et al. 2003), although its sufficiency is already questioned (Goetze 2003). With a slower evolutionary rate of this cytochrome c oxidase, this marker is not applicable for flowering plants (Kress et al. 2005).

One of the most discussed marker in fungal taxonomy and phylogenetics is still the ITS region with all its afore mentioned advantages and disadvantages (see Sect. 5).

Nevertheless, provided sequence data usable for species identification for anaerobic gut fungi are restricted, e.g., only 163 “ITS” tagged sequences are assigned to the order Neocallimastigales (465 nucleotide sequences in summary, compare Fig. 14.6), with only 17 sequences assigned to full taxon names. Because of missing mitochondria in anaerobic fungi (hydrogenosomes instead), mitochondrial based barcode markers are out of question (Bullerwell and Lang 2005). The need for a complete barcoding database, as always demanded (Ekrem 2007), is obvious. But another major drawback is the data deposited in such a barcode database. An adequate number of well-defined reference specimens are a prerequisite for species identification and especially for species discovery. Such references should encompass all possible variances within defined species boundaries, e.g., geographically based variations (DeSalle et al. 2005; Meyer and Paulay 2005).

Originally thought to be a fast, cheap, and easy-to-access method for the assignment of “unknown” to “known” specimens, molecular barcoding should be used with caution. On the one hand, supplementing a barcode marker with additional information about e.g., morphology, biogeography, or even more molecular data will miss the aim of a single easy-to-use marker for species assignment. But on the other hand, supplementing data is necessary as a specimen cannot be identified or described with certainty by one molecular attribute (Brower 2006; Will et al. 2005). Storing new data in a database is always tied with responsibility of the submitter. Open-access to such databases is necessary but at the same time prone to errors and losing its value as shown by GenBank at the NCBI (Bridge et al. 2003).

## 14.7 Conclusion and Future Line of Research

According to the efforts of Aguilera et al. (2008) and Schmitt et al. (2009) more alternative barcoding markers need to be established and validated in order to get a reliable identification which is in concordance with morphological and ultrastructural characters. The increase of the complexity of research on anaerobic rumen fungi in their composite ecosystems requires a common platform for strain and data shared among the scientific community. It is necessary to gain a certain homogeneity and common use of reference and type strains including reference sequences of barcode markers and other characters suitable for a reliable identification of anaerobic rumen fungi. This is a fundamental for cultivation-independent detection in the natural ecosystems and habitats of anaerobic fungi as performed by Fliegerová et al. (2010).

**Acknowledgments** The authors express their gratitude to L. Jay Yanke (Agriculture and Agri-Food Canada, Lethbridge Research Centre, Lethbridge, AB, Canada) for providing *Neocallimastix frontalis* strain SR4. This project was a component of the institutional research plan (AV OZ 5045 0515) of the *Institute of Animal Physiology and Genetics, Academy of Sciences of the Czech Republic* in Prague. The czech team was supported by *The National Agency for Agriculture Research* (project no. QI92A286/2008), The german team was supported by the *Deutsche Forschungsgemeinschaft* (project no. Vo 772/7-1), which is part of a bilateral grant between the Czech Science Foundation and the Deutsche Forschungsgemeinschaft.

## References

- Adl SM, Simpson AGB, Farmer MA, Andersen RA, Anderson OR, Barta JR, Bowser SS, Brugerolle G, Fensome RA, Fredericq S, James TY, Karpov S, Kugrens P, Krug J, Lane CE, Lewis LA, Lodge J, Lynn DH, Mann DG, McCourt RM, Mendoza L, Moestrup O, Mozley-Standridge SE, Nerad TA, Shearer CA, Smirnov AV, Spiegel FW, Taylor MFJR (2005) The new higher level classification of eukaryotes with emphasis on the taxonomy of protists. *J Eukaryot Microbiol* 52:399–451
- Aguileta G, Marthey S, Chiapello H, Lebrun MH, Rodolphe F, Fournier E, Gendault-Jacquemard A, Giraud T (2008) Assessing the performance of single-copy genes for recovering robust phylogenies. *Syst Biol* 57:613–627
- Ainsworth GC (1966) A general purpose classification of the fungi. *Bibl System Mycol* 4:1–4
- Alexopoulos CJ, Mims CW (1979) Introductory Mycology 38:1–613
- Arnheim N (1983) Concerted evolution of multigene families. In: Nei M, Koehn RK (eds) *Evolution of genes and proteins*. Sinauer Associated, Sunderland, MA, pp 38–61
- Barr DJS (1978) Taxonomy and phylogeny of chytrids. *Biosystems* 10:153–165
- Barr DJS, Kudo H, Jakober KD, Cheng KJ (1989) Morphology and development of rumen fungi: *Neocallimastix* sp., *Piromyces communis*, and *Orpinomyces bovis* gen.nov., sp.nov. *Can J Bot* 67:2815–2824
- Bartnicki-Garcia S (1970) Cell wall composition and other biochemical markers in fungal phylogeny. In: Harborne JB (ed) *Phytochemical phylogeny*. Academic Press, New York, pp 81–103
- Bergsten J (2005) A review of long-branch attraction. *Cladistics* 21(2):163–193
- Bowman BH, Taylor JW, Brownlee AG, Lee J, Lu S, White TJ (1992) Molecular evolution of the fungi: relationship of the basidiomycetes, ascomycetes, and chytridiomycetes. *Mol Biol Evol* 9:285–296
- Braune R (1913) Untersuchungen über die im Wiederkäuermagen vorkommenden Protozoen. *Arch Protistenk* 32:111–170
- Breton A, Bernalier A, Dusser M, Fonty G, Gaillard-Martinie B, Guillot J (1990) *Anaeromyces mucronatus* nov. gen., nov. sp. A new strictly anaerobic rumen fungus with polycentric thallus. *FEMS Microbiol Lett* 70:177–182
- Bridge PD, Roberts PJ, Spooner BM, Panchal G (2003) On the unreliability of published DNA sequences. *New Phytol* 160:43–48
- Brookman JL, Mennim G, Trinci AP, Theodorou MK, Tuckwell DS (2000) Identification and characterization of anaerobic gut fungi using molecular methodologies based on ribosomal ITS1 and 18S rRNA. *Microbiology* 146:393–403
- Brower AVZ (2006) Problems with DNA barcodes for species delimitation: ‘ten species’ of *Astraptes fulgerator* reassessed (Lepidoptera: Hesperidae). *Syst Biodivers* 4:127–132
- Bullerwell CE, Lang BF (2005) Fungal evolution: the case of the vanishing mitochondrion. *Curr Opin Microbiol* 8:362–369
- DeSalle R, Egan MG, Siddall M (2005) The unholy trinity: taxonomy, species delimitation and DNA barcoding. *Philos Trans R Soc Lond B Biol Sci* 360:1905–1916
- Doré J, Stahl DA (1991) Phylogeny of anaerobic rumen Chytridiomycetes inferred from small subunit ribosomal RNA sequence comparisons. *Can J Bot* 69:1964–1971
- Ebersberger I, Strauss S, Kupczok A, Kothe E, von Haeseler A, Gube M, Eckart M, Voigt K (2010) A stable backbone for the fungi. in revision
- Ekrem T, Willassen E, Stur E (2007) A comprehensive DNA sequence library is essential for identification with DNA barcodes. *Mol Phylogenet Evol* 43:530–542
- Felsenstein J (1985) Confidence limits of phylogenies: an approach using the bootstrap. *Evolution* 39:783–791
- Fliegerová K, Mrázek J, Voigt K (2006) Differentiation of anaerobic polycentric fungi by rDNA PCR-RFLP. *Folia Microbiol (Praha)* 51:273–277

- Fliegerová K, Mrázek J, Hoffmann K, Zábanská J, Voigt K (2010) Diversity of anaerobic fungi within cow manure determined by ITS1 analysis. *Folia Microbiol (Praha)*: in press
- Förster H, Coffey MD, Elwood H, Sogin ML (1990) Sequence analysis of the small subunit ribosomal RNAs of three zoospore fungi and implications for fungal evolution. *Mycologia* 82:306–312
- Goetze E (2003) Cryptic speciation on the high seas; global phylogenetics of the copepod family Eucalanidae. *Proc R Soc B* 270:2321–2331
- Gold JJ, Heath IB, Bauchop T (1988) Ultrastructural description of a new chytrid genus of caecum anaerobe, *Caecomyces equi* gen. nov., sp. nov., assigned to the Neocallimasticaceae. *BioSystems* 21:403–415
- Heath IB, Bauchop T, Skipp RA (1983) Assignment of the rumen anaerobe *Neocallimastix frontalis* to the Spizellomycetales (Chytridiomycetes) on the basis of its polyflagellate zoospore ultrastructure. *Can J Bot* 61:295–307
- Hebert PDN, Ratnasingham S, deWaard JR (2003) Barcoding animal life: cytochrome c oxidase subunit 1 divergences among closely related species. *Proc R Soc B* 270(Suppl):96–99
- Hebert PD, Penton EH, Burns JM, Janzen DH, Hallwachs W (2004) Ten species in one: DNA barcoding reveals cryptic species in the neotropical skipper butterfly *Astraptes fulgerator*. *Proc Natl Acad Sci USA* 101:14812–14817
- Hibbett DS, Binder M, Bischoff JF, Blackwell M, Cannon PF, Eriksson OE, Huhndorf S, James T, Kirk PM, Lücking R, Lumbs HT, Lutzoni F, Matheny PB, McLaughlin DJ, Powell MJ, Redhead S, Schoch CL, Spatafora JW, Stalpers JA, Vilgalys R, Aime MC, Aptroot A, Bauer R, Begerow D, Benny GL, Castlebury LA, Crous PW, Dai YC, Gams W, Geiser DM, Griffith GW, Gueidan C, Hawksworth DL, Hestmark G, Hosaka K, Humber RA, Hyde KD, Ironside JE, Kõljalg U, Kurtzman CP, Larsson KH, Lichtwardt R, Longcore J, Miadlikowska J, Miller A, Moncalvo JM, Mozley-Standridge S, Oberwinkler F, Parmasto E, Reeb V, Rogers JD, Roux C, Ryvarden L, Sampaio JP, Schüssler A, Sugiyama J, Thorn RG, Tibell L, Untereiner WA, Walker C, Wang Z, Weir A, Weiss M, White MM, Winka K, Yao YJ, Zhang N (2007) A higher-level phylogenetic classification of the fungi. *Mycol Res* 111:509–547
- Hightower RC, Meagher RB (1986) The molecular evolution of actin. *Genetics* 114:315–332
- Ho Y, Barr D (1995) Classification of anaerobic gut fungi from herbivores with emphasis on rumen fungi from Malaysia. *Mycologia* 87:655–677
- Ho YW, Khoo IY, Tan SG, Abdullah N, Jalaludin S, Kudo H (1994) Isozyme analysis of anaerobic rumen fungi and their relationship to aerobic chytrids. *Microbiology* 140:1495–1504
- Hungate RE (1966) *The rumen and its microbes*. Academic Press, New York
- James TY, Letcher PM, Longcore JE, Mozley-Standridge SE, Porter D, Powell MJ, Griffith GW, Vilgalys R (2006) A molecular phylogeny of the flagellated fungi (Chytridiomycota) and a proposal for a new phylum (Blastocladiomycota). *Mycologia* 98:860–871
- Kirk PM, Cannon PF, Minter DW, Stalpers JA (2008) *Dictionary of the fungi*, 10th edn. CABI Publishing, Wallingford, UK
- Kress WJ, Wurdack KJ, Zimmer EA, Weigt LA, Janzen DH (2005) Use of DNA barcodes to identify flowering plants. *Proc Natl Acad Sci USA* 102:8369–8374
- Li J, Heath IB, Packer L (1993) The phylogenetic relationships of the anaerobic chytridiomycetous gut fungi (Neocallimasticaceae) and the Chytridiomycota II. Cladistic analysis of structural data and description of Neocallimasticales ord. nov. *Can J Bot* 71:393–407
- Liebetanz E (1910) Die parasitischen Protozoen des Wiederkäuermagens. *Arch Protistenk* 19:19–90
- Meyer CP, Paulay G (2005) DNA barcoding: error rates based on comprehensive sampling. *PLoS Biol* 3:e422
- Munn EA, Orpin CG, Greenwood CA (1988) The ultrastructure and possible relationships of four obligate anaerobic chytridiomycete fungi from the rumen of sheep. *Biosystems* 22:67–81
- Nilsson RH, Kristiansson E, Ryberg M, Hallenberg N, Larsson K (2008) Intraspecific ITS variability in the kingdom fungi as expressed in the international sequence databases and its implications for molecular species identification. *Evol Bioinform* 4:193–201

- Orpin CG (1974) The rumen flagellate *Callimastix frontalis*: does sequestration occur? J Gen Microbiol 84:395–398
- Orpin CG (1975) Studies on the rumen flagellate *Neocallimastix frontalis*. J Gen Microbiol 91:249–262
- Orpin CG (1976) Studies on the rumen flagellate *Sphaeromonas communis*. J Gen Microbiol. 94:270–280
- Orpin CG (1977) Invasion of plant tissue in the rumen by the flagellate *Neocallimastix frontalis*. J Gen Microbiol 98:423–430
- Orpin C, Munn E (1986) *Neocallimastix patriciarum*: a new member of the Neocallimasticaceae inhabiting the sheep rumen. Trans Br Mycol Soc 86:178–181
- Ozkose E, Thomas BJ, Davies DR, Griffith GW, Theodorou MK (2001) *Cyllamyces aberensis* gen. nov. sp. nov., a new anaerobic gut fungus with branched sporangiophores isolated from cattle. Can J Bot 79:666–673
- Samson RA, Frisvad JC (eds) (2004) *Penicillium* subgenus *Penicillium*: new taxonomic schemes, mycotoxins and other extrolites. Stud Mycol 49:1–251
- Schmitt I, Crespo A, Divakar PK, Fankhauser JD, Herman-Sackett E, Kalb K, Nelsen MP, Nelson NA, Rivas-Plata E, Shimp AD, Widhelm T, Lumbsch HT (2009) New primers for promising single copy genes in fungal phylogenetics and systematics. Persoonia 23:35–40
- Skouboe P, Boysen M, Pedersen LH, Frisvad JC, Rossen L (1996) Identification of *Penicillium* species using the internal transcribed spacer (ITS) regions. In: Rossen L, Rubio V, Dawson MT, Frisvad JC (eds) Fungal identification techniques. European Commission, Brussels, Belgium, pp 160–164
- Skouboe P, Frisvad JC, Taylor JW, Lauritsen D, Boysen M, Rossen L (1999) Phylogenetic analysis of nucleotide sequences from the ITS region of terverticillate *Penicillium* species. Mycol Res 103:873–881
- Stamatakis A (2006) RAxML-VI-HPC: Maximum likelihood-based phylogenetic analyses with thousands of taxa and mixed models. Bioinformatics 22(21):2688–2690
- Stamatakis A, Hoover P, Rougemont J (2008) A rapid bootstrap algorithm for the RAxML web-servers. Systematic Biology 57(5):758–771
- van der Giezen M (2002) Strange fungi with even stranger insides. Mycologist 16:129–131
- Vavra J, Joyón L (1966) Etude sur la morphologie, le cycle évolutif et la position systématique de *Callimastix cyclops* Weissenberg, 1912. Protistologica 2:5–16
- Vogel HJ (1964) Distribution of lysine pathways among fungi: evolutionary implications. Am Nat 98:435
- Webb J, Theodorou MK (1991) *Neocallimastix hurleyensis* sp. nov., an anaerobic fungus from the ovine rumen. Can J Bot 69:1220–1224
- Weissenberg S (1912) Sitzungsbericht der Gesellschaft naturforschender Freunde zu Berlin 5:299
- Whisler HC, Zebold SL, Shemanchuk JA (1974) Alternate host for mosquito parasite *Coelomomyces*. Nature 251:715–716
- Whittaker RH (1969) New concepts of kingdoms or organisms. Evolutionary relations are better represented by new classifications than by the traditional two kingdoms. Science 163:150–160
- Whitworth TL, Dawson RD, Magalon H, Baudry E (2007) DNA barcoding cannot reliably identify species of the blowfly genus *Protocalliphora* (Diptera: Calliphoridae) Proc Bio Sci 274:1731–1739
- Will KW, Mishler BD, Wheeler QD (2005) The perils of DNA barcoding and the need for integrative taxonomy. Syst Biol 54:844–851
- Wulff C (2001) Untersuchungen zum Thiamin- und Thiaminderivatgehalt im Pansensaft des Rindes nach Verfütterung von mit *Mucor racemosus* Fresenius verpilztem Heu (in vitro), Thesis, Tierärztliche Hochschule Hannover, Hannover

**Part II**  
**Human Pathological and Clinical Aspects**

# Chapter 15

## New Approaches in Fungal DNA Preparation from Whole Blood and Subsequent Pathogen Detection Via Multiplex PCR

Roland P.H. Schmitz, Raimund Eck, and Marc Lehmann

**Abstract** Sepsis is a life-threatening disease that results from excessive host responses to microbial infections. Fungal pathogens mainly contribute to lethal outcomes and high treatment budgets. Numerous trials revealed that the mortality rates of septic patients could be reduced if appropriate anti-infective approaches are promptly initiated. This demands a forthwith identification of the causative pathogen(s) and antibiotic resistances. However, standard procedures (e.g., blood cultures) deliver first results after 2–3 days. Facing the time-to-result for cultural pathogen detection, culture independent nucleic acid amplification techniques (NAT) are increasingly desirable to deliver a reliable basis for a targeted antibiotic regimen within the first decisive hours of the disease.

Crucial steps in the detection of pathogens within whole blood concern cell lysis and the disproportion of pathogen and human background DNA. Standard analytical methods applied and current developments in sepsis diagnostics are reviewed. New tools are introduced which accelerate the clinical investigation course and improve the sensitivity as well as the quality of NAT-based genus and species detections.

### 15.1 Introduction: Fungi as Sepsis Causative Pathogens

Life-threatening fungal and bacterial infections and their outcomes – sepsis and consecutive organ failure – are frequent complications of hospitalized patients, with an increasing number of 18 million new sepsis cases each year worldwide and with a mortality rate of 30–50% (Slade et al. 2003). Sepsis results from the hosts response to fungal and bacterial (and protozoan) infections, whereas a malfunction of the defence and repair system is responsible for the development of organ dysfunctions and at last multiorgan failure.

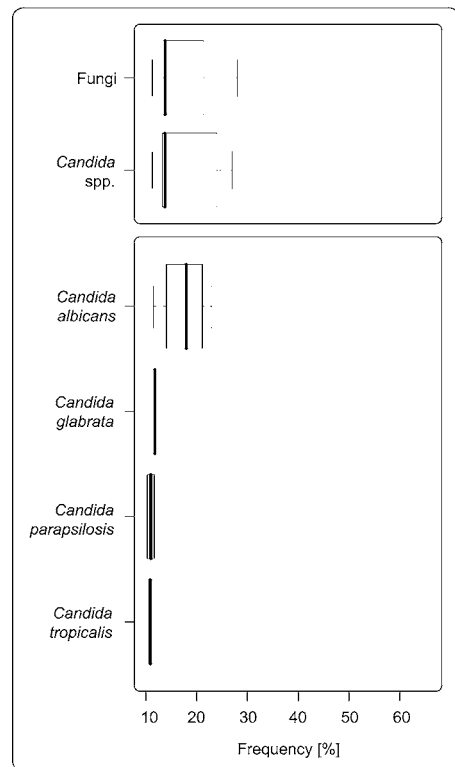
---

R.P.H. Schmitz, R. Eck, and M. Lehmann  
SIRS-Lab GmbH, Winzerlaer Str. 2, 07745 Jena, Germany  
e-mail: schmitz@sirs-lab.com

In Germany, about 60,000 out of 1,54,000 patients die from severe sepsis, which therefore is one of the most frequent causes of death in intensive care units (ICU). The incidence of sepsis has risen due to the use of invasive devices, aging of the population, and the higher incidence of immunosuppressive conditions such as chemotherapy for cancer and acquired immunodeficiency syndrome (AIDS) (Martin et al. 2003). About 30% of the intensive medicine budget is expended for the treatment of those patients (Reinhart et al. 2006). On average, the treatment of candidaemia amounts to about US \$44,536 for each patient, mainly attributed to prolonged hospitalization (Pfaller et al. 2005), whereas treatment of sepsis costs only US \$22,000 per patient in the USA (US \$16.7 billion spent each year for sepsis care; Angus and Wax 2001), which marks the discrepancies in care expenses of septical infections caused by fungal and bacterial pathogens.

From the 1970s to 1990s, septical infections in Germany were attributed mainly to Gram-negative bacterial species, whereas currently Gram-positives, fungi, and multi-infections are rising (Bauer et al. 2006; Karlowsky et al. 2004; Martin et al. 2003). The incidence of fungal species in septical infections was determined to be mainly contributed by *Candida* spp. (Fig. 15.1), especially *C. albicans*, with prominent findings in several clinical studies: compared to bacterial sepsis causative pathogens, the incidence of fungal species was quite significant with *Candida* spp.

**Fig. 15.1** Frequencies of fungal sepsis causative pathogens as determined in 11 clinical studies. Individual species were designated only in a part of the studies, which accounts for their percentage distribution as individual species or fungi/*Candida* sp. The boxplot data were calculated using R (R Development Core Team, 2007). The data were taken from: Bodmann and Vogel (2001); Cockerill et al. (1997); Focht and Adam (2004); Fridkin and Gaynes (1999); Geerdes et al. (1992); Geffers et al. (2004); Jones et al. (2004); Karlowsky et al. (2004); Kübler et al. (2004); Styers et al. (2006); Vincent et al. (2006); R: A language and environment for statistical computing. R Foundation for Statistical Computing (2007) Vienna, Austria, ISBN 3-900051-07-0





10%, *Aspergillus* spp. 5–15%, and *Fusarium* spp. < 2% (Richardson and Kokki 1999; Vincent et al. 1998; Duthie and Denning 1995; Gamis et al. 1991).

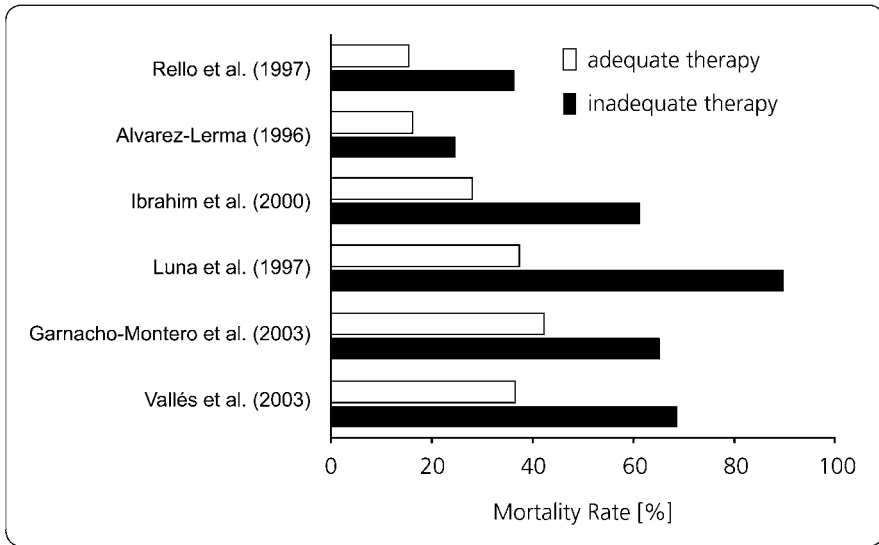
*Candida albicans* was then identified to be the fifth and seventh frequent causative pathogen of nosocomial infections in Germany and the USA, respectively (Gefferers et al. 2004; Fridkin and Gaynes 1999), while candidaemia in general accounts for the fourth frequent nosocomial infection affecting the blood circuit (Liu et al. 2006; Gudlaugsson et al. 2003; Pappas et al. 2003). The spectrum of nosocomial fungal pathogens in particular comprises mainly yeasts – first of all *C. albicans* (>50%), followed by non-*C. albicans* *Candida* spp. (~45%, e.g., *C. glabrata*, *C. krusei*, *C. parapsilosis*, *C. tropicalis*) as well as molds (2–5%, e.g., *Aspergillus* spp.). The lethality of nosocomial *C. albicans* infections was quoted to be 22–40% (Gudlaugsson et al. 2003; Nolla-Salas et al. 1997; Fraser et al. 1992; Wey et al. 1988).

The incidence of sepsis and the number of sepsis-related deaths were increasing in the USA, although the overall mortality rate among patients with sepsis was declining: the rate of sepsis due to fungal organisms increased by 207% between 1979 and 2000 (with Gram-positive bacteria becoming the predominant pathogens after 1987) (Martin and Mannino 2003). Candidaemia occurrence was proven to be associated with an extraordinary high mortality rate among critically ill patients: in fungal infections the patients mortality was >60% (85% and 45.2% in medical and surgical patients, respectively) (Charles et al. 2003). Causing identical clinical syndromes in severe sepsis/septic shock, the mortality of patients with bacterial infections was only determined to be 30–50%. About 70% of all fungal infections were diagnosed *post mortem* (Schmidt et al. 1991).

## 15.2 Sepsis Diagnostics: An Overview of Current Methods

Given the high mortality rates from patients suffering from candidaemia, there is an obvious need for more accurate and rapid identification strategies. Early detection of systemic fungal infection and prompt and adequate antibiosis in the first few hours of infection are the crucial steps for an effective sepsis therapy (Garnacho-Montero et al. 2003; Fine et al. 2002; Ibrahim et al. 2000). Epidemiological data confirm that a doubling of mortality is the consequence of inadequate therapies (Vallés et al. 2003) (Fig. 15.2) and an increase of mortality of more than ~7% per hour is proven in cases of delayed adequate (directed) antibiotic treatment in case of sepsis, irrespective of the causative pathogen (Iregui et al. 2002). Unsurprisingly, an increase of mortality has also been proven for delayed empirical (nondirected) therapies in cases of systemic candidiasis (Morrell et al. 2005).

Diagnosis of invasive fungal infections (IFI) is generally based on direct pathogen detection in body fluids and in aseptically withdrawn samples of the skin, lung, liver, and CNS biopsy, respectively, via growth cultures. A histological proof within inflamed tissue is also accepted (Ascioglu et al. 2002). However, the conventional identification of pathogenic fungi in clinical microbiology



**Fig. 15.2** Reduction of mortality by adequate antibiotic therapy

laboratories bases on phenotypic features and physiological tests and remains a significant problem in general. The clinical symptoms are difficult to interpret and the findings of noninvasive methods (e.g., computed tomographic scanning and X-ray) are not specific (Richardson and Kokki 1999). Deep-tissue sample cultures from infections with focal lesions are frequently negative (Vincent et al. 1998; Duthie and Denning 1995). Direct microscopy and histopathological examination are rapid, but they do not always allow identification of the infecting agent to the species level (Richardson and Kokki 1999; Vincent et al. 1998).

Even though monoclonal antibody-based enzyme-linked immunosorbent assays (ELISAs) for circulating *Aspergillus* and *Candida* antigens (e.g., Cand-Tec<sup>®</sup> latex agglutination assay, Ramco Laboratories, Houston, Texas) are somewhat specific, they lack sensitivity (Richardson and Kokki 1999). Furthermore, the detection of *Candida* sp. antibodies may also be attributed to a mucocutaneous infection and is no proof for an invasion, and antibody production may fail to appear in case of immunocompromised patients.

$\beta$ -D-glucan, a component of the fungal cell wall, has become a diagnostic parameter for IFIs (Alam et al. 2007; Odabasi et al. 2004). The available assays use saccharide-specific antibodies or limulus amebocyte lysates (LAL) of the horseshoe crab, which is used for years for endotoxin detection to measure the non-*Candida*-specific 1,3- $\beta$ -D-glucan level. The concentration of 1,3- $\beta$ -D-glucan in plasma of patients with IFI was markedly increased. However, the LAL-based assays from Japan (e.g., Fungitec-G<sup>®</sup>; Lü et al. 2007) or USA (e.g., GlucateLL<sup>®</sup>), are still not validated for the sole diagnosis of IFIs. They cannot be applied to differentiate aspergillosis from yeast fungus infection, are soonest to be used 3 days postoperatively, and deliver different assay-specific results.

D-arabinitol, a further putative target metabolite and exclusive fungal metabolic product is not produced by *C. glabrata* and *C. krusei* and is therefore of restricted diagnostic relevance for fungi in general (Walsh et al. 1995). Fungal serum mannan acts as an early antigen marker for candidaemia (Fujita et al. 2006). The Platelia<sup>®</sup> *Candida* Antigen EIA (Bio-Rad; sensitivity 42%, specificity 98%) may be tested negative in patients with anti-mannan antibodies. Therefore, determination of the anti-mannan antibody concentration is recommended. The sensitivity of the combined assay increases to 76%, the specificity to 93% (Sendid et al. 2003). Fungal serum mannan and at least fungal enolase tests (Yeo and Wong 2002) might at least be promising for the early detection of invasive candidiasis, but show short serum half-times and the latter affords complex measurement techniques.

In general, antibodies directed against fungal targets are of epidemiological value but antigenic extracts are not yet standardized. The proteins are first seen in a late stadium within the course of the disease and are in general of limited use in immunosuppressed patients. Serological test may in general contribute to IFI diagnostics but have to be assessed by further cultural and clinical data or combined even with current molecular diagnostics (Yeo and Wong 2002).

While clinical manifestations of inflammations are elusive, some biochemical parameters indicate early stages of fungal or bacterial infections. The presence of three biomarkers was proven in systemic infections: C-reactive protein (CRP), procalcitonin (PCT), and D-dimer. None of them, however, functions as single independent criterion for sepsis (De La Rosa et al. 2008).

CRP, an acute-phase protein that plays a significant role within the complement pathway, binds to several polysaccharides present in all classes of sepsis causative pathogens. Secretion of CRP starts within several hours of the stimulus peaking between 36 and 50 h. After disappearance of the stimulus, CRP falls rapidly with a half-life of 19 h, but it can remain elevated, even for very long periods, if the underlying cause of the elevation persists. Only interventions affecting the inflammatory process responsible for the acute phase reaction can change the CRP level. Changes may be very helpful in diagnosis as well as in monitoring response to therapy, as CRP levels are only determined by the rate of synthesis (Povoa 2002).

PCT is a 116-amino acid prohormone proven to be a useful marker in sepsis and sepsis-like conditions (e.g., severe burns and mechanical trauma), and also in some infections of nonbacterial causation as systemic fungal infection (Becker et al. 2004). Serum levels of PCT are frequently increased in sepsis patients, sometimes attaining levels several thousand-fold normal, and these high levels often persist for a long period of time. Moreover, the levels often correlate positively with the severity of the condition and mortality (Pettila et al. 2002; Meisner et al. 1999). A good correlation was found between the serum PCT level and the Sepsis-Related Organ Failure Assessment (SOFA) score, although no correlation was found between the latter and the CRP level (Endo et al. 2008). It has been argued that the PCT serum level may be useful in aiding the diagnosis of sepsis and the discrimination between the specific phases of the disease.

Activation of the coagulation cascade is a common and early phenomenon in the development of sepsis, and this fact supports the use of anticoagulant treatments

as potentially useful interventions (Levi and Ten Cate 1999). Anticoagulation releases degradation products containing D-dimers whereas a finding of more than 500 ng of D-dimer per milliliter is considered abnormal, and such levels are present in virtually all patients with sepsis (Opal and Esmon 2003).

However, none of these potential biochemical test parameters which gain information on the status of inflammation and altered along with the development of sepsis, especially parameters regarding the host-response on invasive infections, pathogen cell components, or at least metabolic by-products, do permit access to a directed therapy of the disease. This exclusively demands the identification of the causative agent and putative antibiotic resistances which it exhibits.

Various commercial cultural systems that are able to identify sepsis causative pathogens within 4–72 h have been developed. Although correct identification of clinically relevant yeast strains can be achieved with these systems, incomplete or incorrect identifications may occur when certain new and emerging yeast strains are tested (Espinel-Ingroff et al. 1998). The gold standard technique blood culture, which is the routine method in clinical microbiology laboratories to demonstrate the presence of pathogens in patients suspected of systemic infections, exhibits some drawbacks due to the patient's antibiotic treatment prior to sample withdrawal, a low abundance of causative agents in the blood samples, and frequently noncultivable organisms. The blood culture remains negative in 80–90% of all sepsis incidents and takes a period of usually 24–72 h to obtain results, whereas a sample can be reliably declared negative within up to 7 days. The culture-based phenotypic identification of *Candida* species from clinical materials, for example, requires at least another day to obtain pure cultures. The results then become the basis for further microbial diagnostics, e.g., species differentiation, biochemical typing, and/or generation of antifungal or antibacterial susceptibility profiles, which are also laborious and time-consuming although the methods are in part automated.

### 15.3 Fate of Antimycosis

The time-to-result of blood cultures is too long to initiate an effective sepsis therapy. Therefore, broad spectrum antibiotics are given simultaneously or prior to blood withdrawal without trusted microbiological findings which enhances the broadening of multi-resistant organisms and downsizes the efforts of later taken blood cultures (Chastre 2008; de Kraker and van de Sande-Bruinsma 2007; Weinstein 2003). Therapy is usually administered indirectly early in the clinical course of blood stream infections (BSI) and prior to reporting of positive blood culture results. With respect to antimicrobial management, the most important information provided by the clinical microbiology laboratory appeared to be the reporting of positive blood culture and Gram stain results. Antimicrobial susceptibility testing data did not appear to have a comparatively important impact on antimicrobial management among patients with BSI (Munson et al. 2003).

In general, considerable adverse effects have to be faced when antimycotics are given (e.g., Amphotericin B). Crucial factors for the prognosis of patients with systemic mycoses therefore are again start and accuracy of the antimycotic. Additionally, several human fungal pathogens are characterized by high rates of intrinsic resistance. Therefore, identification of fungal pathogens to the species level rather than antifungal drug susceptibility testing is presently the most important step in selection of adequate antifungal agents (Rex and Pfaller 2002). As expected, IFIs have become an important cause of morbidity and mortality among immunocompromised patients, many of whom are undergoing long-term treatment with antifungal agents.

Although there is little evidence of emerging resistance in e.g., *Candida albicans* (Pfaller et al. 2005), long-term treatment may lead to an increase of non-*C. albicans* strains (Marr 2004), *Aspergillus terreus*, and Zygomycetes infections (Wingard 2005; Kauffman 2004). Some *Candida* species are problematic in this respect notwithstanding: *C. glabrata*, *C. rugosa*, and *C. guilliermondi* display low susceptibilities to fluconazole, an otherwise effective, inexpensive broad spectrum antibiotic with excellent penetration and oral absorption properties (this resistance may also come along with voriconazol resistance), and *C. krusei*, which is innately resistant like *Aspergillus* spp. and other molds (Pfaller et al. 2005; Pappas et al. 2003).

In general, candidiasis and aspergillosis are the most common IFIs in patients receiving immunosuppressive treatment, e.g., chemotherapy for cancer or organ transplantation, or in immunodeficient patients, such as patients with AIDS (Ellis et al. 2001; Dasbach et al. 2000; Coleman et al. 1998; Barnes et al. 1996), and in addition to the increasing incidence of IFIs, the number of fungal species which must be considered as potential fungal pathogens has also increased during the last few decades.

## 15.4 Pathogen Detection by Nucleic Acids Amplification Techniques (NAT)

Nucleic acid amplification techniques (NAT, e.g., polymerase chain reaction, PCR) allow a more rapid target and resistance detection within several hours, even from whole blood, compared to culture-based methods. Free fungal and bacterial DNAs, as well as DNA from adherent, phagocytosed, and free intact and nonintact pathogens, are detected while blood cultures contribute only in the presence of viable and metabolic active cells. However, the high sensitivity is decreased by factors such as high fractions of salts, hemin, and other blood ingredients, most of which can be effectively removed by affinity chromatography steps during sample preparation. Foremost human bulk DNA, co-isolated with microbial pathogen nucleic acids from the addressed sample material (e.g., whole blood), is additionally the cause for a minute pathogen to human DNA ratio, increased cross-reactivities with primers, and significantly reduced overall analytical assay sensitivities (Handschrur et al. 2009).

In recent years, numerous nucleic acid-based methods have been developed to improve the diagnosis of mycotic infections and the identification of pathogenic fungi (Mikami 2008; Gottfredsson et al. 1998; Reiss et al. 1998; Walsh and Chanock 1998). Prompt and accurate detection and identification of yeast species are important due to the fact that the virulence of *Candida* isolates for example differs according to the species level, with *C. albicans* being most virulent, followed by *C. tropicalis* (Wingard 1995). Therefore, protocols have been published for the detection and identification of mainly yeast pathogens, including species or group discrimination with specific (Yong et al. 2008; Flahaut et al. 1998; Kobayashi et al. 1999; Skladny et al. 1999; Mannarelli and Kurtzman 1998; Reichard et al. 1997) or panfungal (broad-range) PCR primers (Inácio et al. 2008; van Burik et al. 1998). Probes and restriction fragment length polymorphisms have been described in a number of studies to identify unique ribosomal DNA (rDNA) sequences (Evertsson et al. 2000; Kauffman et al. 2000; Loeffler et al. 2000; Martin et al. 2000; Turin et al. 2000; Turenne et al. 1999; Velegraki et al. 1999; Kappe et al. 1998) and as a matter of fact, primers were directed against targets within the rDNA in several approaches (Evertsson et al. 2000; Wahyuningsih et al. 2000; Elie et al. 1998).

The identification of PCR products was done by gel or capillary electrophoresis (De Baere et al. 2002; Chen et al. 2000; Turenne et al. 1999), PCR amplicon restriction fragment length polymorphism analysis (Fujita and Hashimoto 2000), single-strand conformational polymorphism (Li and Bai 2007), Southern blot hybridization (microarray) assays with oligonucleotide probes (Spiess et al. 2007; Wiesinger-Mayr et al. 2007; Hebart et al. 2000; Shin et al. 1999; Flahaut et al. 1998; Einsele et al. 1997), and random amplification of polymorphic DNA analysis (Stefan et al. 1997). Furthermore, a number of PCR-enzyme immunoassays (EIAs) has been developed (Badiie et al. 2007; Wellinghausen et al. 2004; Lindsley et al. 2001; Elie et al. 1998; Loeffler et al. 1998; Shin et al. 1997; Fujita et al. 1995).

One study showed the applicability of PCR-EIA for the resolution of discrepancies in phenotype-based identification between different institutions (Coignard et al. 2004). Real-time PCR assays have been described for the quantitative detection of either *Candida* or *Aspergillus* species in serum (Challier et al. 2004; White et al. 2003; Costa et al. 2001) or other specimen types (White et al. 2004) and Diaz and Fell (2004) applied the Luminex technology for the detection of pathogenic yeasts of the genus *Trichosporon*. The latter assay combines flow cytometry and nucleotide hybridization via fluorescent beads covalently bound to species-specific capture probes. Upon hybridization, the beads bearing the target amplicons are classified by their spectral addresses with a 635-nm laser. Quantitation of the hybridized biotinylated amplicon is based on fluorescence detection with a 532-nm laser.

Although most of these published PCR-based methods have been useful for the identification of fungal species, they either identify only one species at a time or require a probe hybridization procedure that incurs time and expense. An economically more efficient approach would be the application of protocols capable of identifying broad panels of relevant species in a highly parallel fashion (Palka-Santini et al. 2009; Louie et al. 2008). Additionally, the protocols exclude an optimized procedure for the lysis of fungal cells within the sample material, e.g.,

whole blood or serum, which is a crucial step in nucleic acid detection, and mostly relies on in-house techniques for cell disruption. Beyond any attempts for standardization, the extraction methods for pathogen DNA, i.e., the combination of cell lysis and DNA isolation protocols, produce markedly differing yields of fungal (and bacterial) DNA and thus can significantly affect the results of NAT methods for the respective species (Metwally et al. 2008; Fredricks et al. 2005).

Anyway, mechanical impact has been regarded as the most efficient lysis method for fungal cells (Wong et al. 2007; Müller et al. 1998). Further studies described enzymatic/thermal lysis protocols as superior to mechanical impact (Lugert et al. 2006), but the experience should be argued to be mainly attributed to the mechanical device used and its effective power, lysis matrix, sample to head-space volume ratio within the lysis tubes, and the protocol (device settings) applied. It has to be considered that the lastly cited studies on cell lysis were done with pure fungal cells devoid of human cell material, which significantly affects the lysis of the target cells, but the results of Fredricks et al. (2005), which likewise support mechanical lysis, were obtained from spiked clinical samples, a technique which should basically be recommended for assay development.

However, the mechanical devices of the last generation (e.g., FastPrep<sup>®</sup>-24, MP Biomedicals, Solon, OH, USA), which disrupt cells in periods of several seconds to few minutes while executing figure-8 vertical, angular motions, seem to guarantee for the first time acceptable efficiencies for standardized disruptions of designated rigid pathogen cells within high-volume (i.e.,  $\geq 2$  mL) clinical samples. The cells are ground mostly between glass or ceramic bead sand mixtures of particle sizes between 0.1 and 2.5 mm in diameter. Higher head-space volumes over the sample/bead-matrix suspension support the lysis efficiency, an effect which is obviously noticed in tubes of 15 mL total volume (suspension to head-space volume 2:1). Although mechanical lysis is described as an inexpensive technique, the rotating equipment which ensures sufficient efficiency, has to be regarded as initially quite cost-intensive. Additionally, a DNA extraction method is indispensable for a PCR-based assay and both manual and automated protocols are forthcoming (Loeffler et al. 2002) – the latter often high priced.

A recently launched diagnostic PCR-linked tool bases on a selective lysis of (human) blood cells by chaotropic buffers and quantitative degradation of human nucleic acids via chaotroph-resistant DNase (Horz et al. 2008). The enzyme is subsequently heat-inactivated and bacterial pathogen cells are lysed in a second step to gain their genomic DNA for NAT detection purposes. It has to be questioned if this initially smartly appearing two-step lysis procedure is actually a drawback of the analytical approach, since sublethally affected pathogen cells (e.g., due to antibiotic treatment or impact of the immune system) and Gram-negative thin-walled cells may be disrupted within the first lysis step and lose their genomic (target) DNA (Horz et al. 2008). However, the tool may preferably be suited for rigid cell types, but its applicability for the detection of yeast cells, which has been declared to be covered with the assay panel, has not yet been proven in clinical studies.

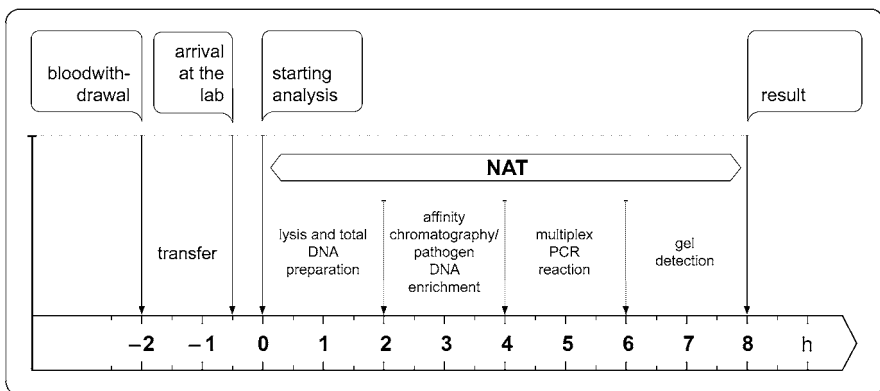
A new multiplex PCR-based assay (VYOO<sup>®</sup>, SIRS-Lab GmbH, Jena) was launched recently and compensates the above mentioned drawbacks by combining



an efficient bead-based mechanical lysis protocol with an extended multiplex PCR detection step (Sachse et al. 2009; Horz et al. 2008). The launched assay includes a unique pretreatment tool which specifically concentrates fungal and bacterial DNA by affinity chromatography and removes human background DNA, the cause for a minute fungal plus bacterial to human DNA ratio within the addressed sample material (e.g., EDTA whole blood). A truncated DNA-binding protein recognizes unmethylated XpYpCpGpXpY motifs within the DNA which are significantly less frequent in humans than in yeast (and bacterial) DNA (Pinarbasi et al. 1996; Wilkinson et al. 1995). An earlier study described different methylation grades between the mycelia and yeast forms of *C. albicans* and outlined an overall lower methylation of fungal DNA compared to DNA from higher eukaryotes (Russell et al. 1987).

However, the enrichment of pathogen DNA significantly increases the sensitivity of the chosen downstream detection method by at least one order of magnitude (Sachse et al. 2009). The standard (as compared to real-time PCR/qPCR assays) multiplex PCR detects an optimized panel of six fungal (*A. fumigatus*, *C. albicans*, *C. glabrata*, *C. krusei*, *C. parapsilosis*, and *C. tropicalis*) (and 34 bacterial) species that cause life-threatening infections and comprise 99% of sepsis-causative pathogens (as confirmed by the frequencies of pathogens via meta-analysis of 11 clinical studies, see above legend to Fig. 15.1), as well as a set of important antibiotic resistances (e.g., methicillin, vancomycin,  $\beta$ -lactamase). The test has been designed for the examination of the generated amplicons by gel-electrophoresis or hybridization methodologies. The latter is demanded for increased sensitivities and result verification. However, using amplicon-specific DNA length markers, the amplicon identification works straightforward and allows for results within 8 h – an important benefit in sepsis diagnostics compared to assays which rely on preculturing of viable cells (i.e., blood culture) (Lau et al. 2008) (Fig. 15.3).

The crucial step in pathogen detection from whole blood is the low abundance of pathogen cells within the circuit. A high percentage of bacteraemia gained positive blood cultures from blood samples possessing less than 10 cfu of pathogen cells per



**Fig. 15.3** Time course of the detection of fungal causative pathogens with VYOO<sup>®</sup>



mL (Kreger et al. 1980). Sine qua non for a new NAT-based assay is therefore a sensitivity which enters this analytical range to compete with the standard techniques in the lab and with the medical tradition which has to be persuaded for the effectiveness of nucleic acid based assay systems. *C. albicans*, for example, was detected in EDTA whole blood after spiking, using the new multiplex PCR tool and gelelectrophoretic amplicon detection with a sensitivity of <20 cfu/mL, a level which was attained previously only by qPCR-based techniques (Lehmann et al. 2008) requiring high-priced analytical devices and confined by restricted numbers of detectable targets due to the available wavelength-specific fluorescence dyes (e.g., 6-carboxy-fluorescein/FAM) and/or fluorescence channels of the qPCR device used. Their number is in fact growing with the state of the art, but to achieve a still limited but increased multiplex applicability fluorescence detection (e.g., via dual fluorescence resonance energy transfer probes targeting species-specific internal transcribed spacer (ITS) regions of PCR amplicons (Dunyach et al. 2008; Mancini et al. 2008)), is combined with error-prone melting point analyzes and done with a high workload (Schrenzel 2007).

The progress of the new standard multiplex procedure has in part to be attributed to the high sample volume of 5 mL whole blood which can be applied, regardless of the benefits of the usage of 15 mL centrifugation vials within the lysis step (see above). The importance of the blood volume cultured or processed in NAT-based methods has been discussed long ago (Arpi et al. 1989); however, the implications of reduced sample volumes has been accepted for the qPCR evaluation due to the always aspired miniaturization of assay layouts.

The innovative part of the new multiplex PCR assay, however, remains the protein-based pathogen-DNA affinity chromatography step which is additionally sold as an assay-independent pretreatment tool (LOOXSTER<sup>®</sup>), which may substantially enhance even home-brew NAT-based assays, and the unmatched ultra-high multiplex assay for the simultaneous detection of fungal (and bacterial) pathogens within one working day.

## 15.5 Conclusion and Future Line of Research

In recent years, a broad spectrum of PCR-based methods for the detection of sepsis causative fungal pathogens has been developed and some of them might be suitable to support and expedite clinical findings and strengthen a directed and restricted antibiotic therapy. A standardization, however, is not yet in sight. At present, only sparse information is available on potential cost benefits for application of molecular diagnosis versus conventional detection of bloodstream infections (Falagas and Panayotis 2008) but it has to be assumed, that the high initial and running costs will be outweighed by the increased assay sensitivity and reduced time-to-result.

The assays are in part compromised by their exquisite sensitivities responsible for nucleic acid trace detection already present in associated consumables or introduced via applying routine sample withdrawal techniques causing false-positive results.

Origin and clinical significance of those “false-positive” samples are often ambiguous and might belong to yet unknown host-pathogen interactions (Schrenzel 2007). Positive NAT-related findings therefore have to be correlated with other clinical observations and diagnostic tests by clinicians and should not be the sole reason for any therapeutical consequences. It should be remembered that three decades ago culture-positive bacteraemia was reported after tooth brushing (Berger et al. 1974), which indicates the range of risk factors that obtain false-positives and the difficulties in distinguishing them from true-positives, a problem which might also be assigned to fungaemia in general. The usage of broad-range primers should be consciously balanced in favor of particular species detections. The amplification method itself, e.g., loop-mediated isothermal amplification (LAMP), ligase chain reaction, nucleic acid sequence-based amplification (NASBA), self-sustained sequence replication (3SR), strand displacement amplification (SDA), transcription-mediated amplification (TMA), or cycling probe technology (CPT), as listed by Schrenzel (2007), may in part significantly alter and improve the sensitivity of the invented verification procedure – the NAT itself will only be as suitable as the associated total DNA release and isolation protocols are – and of course, the approach of getting rid of bulk DNA and polymerase inhibitors. What is required are combined multitarget assay systems with proven clinical utility and that offer high negative predictive values with notwithstanding high analytical sensitivities and low detection thresholds.

Further approaches in test development should focus on standardization and ongoing shortening of the clinical course, e.g., via automation of test flows. Coated magnetic bead particles, e.g., for covalent binding of proteins and antibodies (e.g., for affinity chromatography), capture of biotinylated biomolecules (e.g., for hybridization techniques), DNA separation, or immunological applications (e.g., enzyme-linked immunosorbent assays, ELISA), are already used in many applications, since centrifugation is not required due to the separation of the beads, sized from 50 nm to approximately 3 µm in diameter, from aqueous phases with magnets. Time-consuming DNA-sedimentations and redilutions are circumvented.

The combination of multiplex PCR with microarrays on chips in part placed at the bottom of reaction vials (e.g., ArrayTube<sup>®</sup> system, Clondiag, Jena, Germany) represents a currently tedious and laborious but forward-looking development. A new gold standard for the detection of fungal pathogens, however, not yet found, will for sure be nucleic acid based as announced by the current diagnostic achievements.

**Acknowledgments** The work was supported by grants from the Thuringian Ministry of Economy, Technology and Labour (TMWTA 2007 FE 0255).

## References

- Alam FF, Mustafa AS, Khan ZU (2007) Comparative evaluation of (1, 3)-β-D-glucan, mannan and anti-mannan antibodies, and *Candida* species-specific snPCR in patients with candidaemia. BMC Infect Dis 7:103

- Alvarez-Lerma F (1996) Modification of empiric antibiotic treatment in patients with pneumonia acquired in the intensive care unit. ICU-Acquired Pneumonia Study Group. *Intensive Care Med* 22:387–394
- Angus DC, Wax RS (2001) Epidemiology of sepsis: an update. *Crit Care Med* 29:S109–S116
- Arpi M, Bentzon MW, Jensen J, Frederiksen W (1989) Importance of blood volume cultures in the detection of bacteraemia. *Eur J Clin Microbiol Infect Dis* 8:838–842
- Ascioglu S, Rex JH, de Pauw B, Bennett JE, Bille J, Crockaert F, Denning DW, Donnelly JP, Edwards JE, Erjavec Z, Fiere D, Lortholary O, Maertens J, Meis JF, Patterson TF, Ritter J, Selleslag D, Shah PM, Stevens DA, Walsh TJ (2002) Defining opportunistic invasive fungal infections in immunocompromised patients with cancer and hematopoietic stem cell transplants: an international consensus. Invasive Fungal Infections Cooperative Group of the European Organization for Research and Treatment of Cancer. Mycoses Study Group of the National Institute of Allergy and Infectious Diseases. *Clin Infect Dis* 34:7–14
- Badie P, Kordbacheh P, Alborzi A, Malekhoseini S, Zeini F, Mirhendy H, Mahmoodi M (2007) Prospective screening in liver transplant recipients by panfungal PCR-ELISA for early diagnosis of invasive fungal infections. *Liver Transpl* 13:1011–1016
- Barnes RA, Denning DW, Evans EGV, Hay RJ, Kibbler CC, Prentice AG, Richardson MD, Roberts MM, Rogers TR, Speller DC, Warnock DW, Warren RE (1996) Fungal infections: a survey of laboratory services for diagnosis and treatment. *Commun Dis Rep Rev* 6:R69–R75
- Bauer M, Brunkhorst FM, Welte T, Gerlach H, Reinhart K (2006) Sepsis – aktuelle Aspekte zur Pathophysiologie, Diagnostik und Therapie. *Anaesthesist* 55:835–845
- Becker KL, Nylen ES, White JC, Muller B, Snider RH Jr (2004) Clinical review 167: procalcitonin and the calcitonin gene family of peptides in inflammation, infection, and sepsis: a journey from calcitonin back to its precursors. *J Clin Endocrinol Metab* 89:1512–1525
- Berger SA, Weitzman S, Edberg SC, Casey JI (1974) Bacteraemia after the use of an oral irrigation device. A controlled study in subjects with normal-appearing gingiva: comparison with use of a toothbrush. *Ann Intern Med* 80:510–511
- Bodmann K-F, Vogel F (2001) Antimikrobielle Therapie der Sepsis. *Chemother J* 10:43–56
- Challier S, Boyer S, Abachin E, Berche P (2004) Development of a serum-based TaqMan real-time PCR assay for diagnosis of invasive aspergillosis. *J Clin Microbiol* 42:844–846
- Charles PE, Doise JM, Quenot JP, Aube H, Dalle F, Chavanet P, Milesi N, Aho LS, Portier H, Blettery B (2003) Candidaemia in critically ill patients: difference of outcome between medical and surgical patients. *Intensive Care Med* 29:2162–2169
- Chastre J (2008) Evolving problems with resistant pathogens. *Clin Microbiol Infect* 14:3–14
- Chen YC, Eisner JD, Kattar MM, Rassouljian-Barrett SL, Lafe K, Yarfitz SL, Limaye AP, Cookson BT (2000) Identification of medically important yeasts using PCR-based detection of DNA sequence polymorphisms in the internal transcribed spacer 2 region of the rRNA genes. *J Clin Microbiol* 38:2302–2310
- Cockerill FR 3rd, Hughes JG, Vetter EA, Mueller RA, Weaver AL, Ilstrup DM, Rosenblatt JE, Wilson WR (1997) Analysis of 281, 797 consecutive blood cultures performed over an 8-year period: trends in micro-organisms isolated and the value of anaerobic culture of blood. *Clin Infect Dis* 24:403–418
- Coignard C, Hurst SF, Benjamin LE, Brandt ME, Warnock DW, Morrison CJ (2004) Resolution of discrepant results for *Candida* species identification by using DNA probes. *J Clin Microbiol* 42:858–861
- Coleman DC, Rinaldi MG, Haynes KA, Rex JH, Summerbell RC, Anaissie EJ, Li A, Sullivan DJ (1998) Importance of *Candida* species other than *Candida albicans* as opportunistic pathogens. *Med Mycol* 36:156–165
- Costa C, Vidaud D, Olivi M, Bart-Delabesse E, Vidaud M, Bretagne S (2001) Development of two real-time quantitative TaqMan PCR assays to detect circulating *Aspergillus fumigatus* DNA in serum. *J Microbiol Methods* 44:263–269
- Dasbach EJ, Davies GM, Teutsch SM (2000) Burden of aspergillosis-related hospitalizations in the United States. *Clin Infect Dis* 31:1524–1528

- De Baere T, Claeys G, Swinne D, Verschraegen G, Muylaert A, Massonet C, Vaneechoutte M (2002) Identification of cultured isolates of clinically important yeast species using fluorescent fragment length analysis of the amplified internally transcribed rRNA spacer 2 region (ITS2). *BMC Microbiol* 2:21
- de Kraker M, van de Sande-Bruinsma N (2007) Trends in antimicrobial resistance in Europe: update of EARSS results. *Euro Surveill* 12:E070315.3
- De La Rosa GD, Valencia ML, Arango CM, Gomez CI, Garcia A, Ospina S, Osorno S, Henao A, Jaimes FA (2008) Toward an operative diagnosis in sepsis: a latent class approach. *BMC Infect Dis* 8:18
- Diaz MR, Fell JW (2004) High-throughput detection of pathogenic yeasts of the genus *Trichosporon*. *J Clin Microbiol* 42:3696–3706
- Dunyach C, Bertout S, Phelipeau C, Drakulovski P, Reynes J, Mallié M (2008) Detection and identification of *Candida* spp. in human serum by LightCycler real-time polymerase chain reaction. *Diagn Microbiol Infect Dis* 60:263–271
- Duthie R, Denning DW (1995) *Aspergillus* fungaemia: report of two cases and review. *Clin Infect Dis* 20:598–605
- Einsele H, Hebart H, Roller G, Löffler J, Rothenhofer I, Muller CA, Bowden RA, van Burik J, Engelhard D, Kanz L, Schumacher U (1997) Detection and identification of fungal pathogens in blood by using molecular probes. *J Clin Microbiol* 35:1353–1360
- Elie CM, Lott TJ, Reiss E, Morrison CJ (1998) Rapid identification of *Candida* species with species-specific DNA probes. *J Clin Microbiol* 36:3260–3265
- Ellis ME, Al-Abdely H, Sandridge A, Greer W, Ventura W (2001) Fungal endocarditis: evidence in the world literature, 1965–1995. *Clin Infect Dis* 32:50–62
- Endo S, Aikawa N, Fujishima S, Sekine I, Kogawa K, Yamamoto Y, Kushimoto S, Yukioka H, Kato N, Totsuka K, Kikuchi K, Ikeda T, Ikeda K, Yamada H, Harada K, Satomura S (2008) Usefulness of procalcitonin serum level for the discrimination of severe sepsis from sepsis: a multicenter prospective study. *J Infect Chemother* 14:244–249
- Espinell-Ingroff A, Stockman L, Roberts G, Pincus D, Pollack J, Marler J (1998) Comparison of RapID Yeast Plus system with API 20C system for identification of common, new, and emerging yeast pathogens. *J Clin Microbiol* 36:883–886
- Evertsson U, Monstein HJ, Johansson AG (2000) Detection and identification of fungi in blood using broad-range 28S rDNA PCR amplification and species-specific hybridisation. *Acta Pathol Microbiol Immunol Scand* 108:385–392
- Falagas ME, Panayotis TT (2008) From acute renal failure to acute kidney injury: emerging concepts. *Crit Care Med* 36:1641–1642
- Fine JM, Fine MJ, Galusha D, Petrillo M, Mehan TP (2002) Patient and hospital characteristics associated with recommended processes of care for elderly patients hospitalized with pneumonia. *Arch Intern Med* 162:827–833
- Flahaut M, Sanglard D, Monod M, Bille J, Rossier M (1998) Rapid detection of *Candida albicans* in clinical samples by DNA amplification of common regions from *C. albicans*-secreted aspartic proteinase genes. *J Clin Microbiol* 36:395–401
- Focht J, Adam D (2004) Antibakterielle Aktivität verschiedener Antibiotika. *Klinikerzt* 33:35–38
- Fraser VJ, Jones M, Dunkel J, Storfer S, Medoff G, Dunagan WC (1992) Candidaemia in a tertiary care hospital: epidemiology, risk factors, and predictors of mortality. *Clin Infect Dis* 15:414–421
- Fredricks DN, Smith C, Meier A (2005) Comparison of six DNA extraction methods for recovery of fungal DNA as assessed by quantitative PCR. *J Clin Microbiol* 43:5122–5128
- Fridkin SK, Gaynes RP (1999) Antimicrobial resistance in intensive care units. *Clin Chest Med* 20:303–316
- Fujita S, Hashimoto T (2000) DNA fingerprinting patterns of *Candida* species using HinfI endonuclease. *Int J Syst Evol Microbiol* 50:1381–1380
- Fujita S, Lasker BA, Lott TJ, Reiss E, Morrison CJ (1995) Microtitration plate enzyme immunoassay to detect PCR-amplified DNA from *Candida* species in blood. *J Clin Microbiol* 33:962–967

- Fujita S, Takamura T, Nagahara M, Hashimoto T (2006) Evaluation of a newly developed down-flow immunoassay for detection of serum mannan antigens in patients with candidaemia. *J Med Microbiol* 55:537–543
- Gamis A, Gudnason T, Giebink G, Ramsay N (1991) Disseminated infection with *Fusarium* in recipients of bone marrow transplants. *Rev Infect Dis* 13:1077–1088
- Garnacho-Montero J, Garcia-Garmendia JL, Barrero-Almodovar A, Jimenez-Jimenez FJ, Perez-Paredes C, Ortiz-Leyba C (2003) Impact of adequate empirical antibiotic therapy on the outcome of patients admitted to the intensive care unit with sepsis. *Crit Care Med* 31:2742–2751
- Geerdes HF, Ziegler D, Lode H, Hund M, Loehr A, Fangmann W, Wagner J (1992) Septicemia in 980 patients at a university hospital in Berlin: prospective studies during 4 selected years between 1979 and 1989. *Clin Infect Dis* 15:991–1002
- Geffers C, Zuschneid I, Sohr D, Rüden H, Gastmeier P (2004) Erreger nosokomialer Infektionen auf Intensivstationen: Daten des Krankenhaus-Infektions-Surveillance-Systems (KISS) aus 274 Intensivstationen. *Anästhesiol Intensivmed Notfallmed Schmerzther* 39:15–19
- Gottfredsson M, Cox GM, Perfect JR (1998) Molecular methods for epidemiological and diagnostic studies of fungal infections. *Pathology* 30:405–418
- Gudlaugsson O, Gillespie S, Lee K, Van de Berg J, Hu J, Messer S, Herwaldt L, Pfaller M, Diekema D (2003) Attributable mortality of nosocomial candidaemia, revisited. *Clin Infect Dis* 37:1172–1177
- Handschr M, Karlic H, Hertel C, Pfeilstöcker M, Haslberger AG (2009) Preanalytic removal of human DNA eliminates false signals in general 16S rDNA PCR monitoring of bacterial pathogens in blood. *Comp Immunol Microbiol Infect Dis* 32:207–219
- Hebart H, Löffler J, Meisner C, Serey F, Schmidt D, Bohme A, Martin H, Engel A, Bunje D, Kern WV, Schumacher U, Kanz L, Einsele H (2000) Early detection of *Aspergillus* infection after allogeneic stem cell transplantation by polymerase chain reaction screening. *J Infect Dis* 181:1713–1719
- Horz HP, Scheer S, Huenger F, Vianna ME, Conrads G (2008) Selective isolation of bacterial DNA from human clinical specimens. *J Microbiol Methods* 72:98–102
- Ibrahim EH, Sherman G, Ward S, Fraser VJ, Kollef MH (2000) The influence of inadequate antimicrobial treatment of bloodstream infections on patient outcomes in the ICU setting. *Chest* 118:146–155
- Inácio J, Flores O, Spencer-Martins I (2008) Efficient identification of clinically relevant *Candida* yeast species by use of an assay combining panfungal loop-mediated isothermal DNA amplification with hybridization to species-specific oligonucleotide probes. *J Clin Microbiol* 46:713–720
- Iregui M, Ward S, Sherman G, Fraser VJ, Kollef MH (2002) Clinical importance of delays in the initiation of appropriate antibiotic treatment for ventilator-associated pneumonia. *Chest* 122:262–268
- Jones ME, Draghi DC, Thornsberry C, Karlowsky JA, Sahn DF, Wenzel RP (2004) Emerging resistance among bacterial pathogens in the intensive care unit – a European and North American surveillance study (2991–2002). *Ann Clin Microbiol Antimicrob* 3:1–11
- Kappe R, Okeke CN, Fauser C, Maiwald M, Sonntag H-G (1998) Molecular probes for the detection of pathogenic fungi in the presence of human tissue. *J Med Microbiol* 47:811–820
- Karlowsky JA, Jones ME, Draghi DC, Thornsberry C, Sahn DF, Volturo GA (2004) Prevalence and antimicrobial susceptibilities of bacteria isolated from blood cultures of hospitalized patients in the United States in 2002. *Ann Clin Microbiol Antimicrob* 3:1–8
- Kauffman CA (2004) Zygomycosis: re-emergence of an old pathogen. *Clin Infect Dis* 39:588–590
- Kauffman CA, Vázquez JA, Sobel JD, Gallis HA, McKinsey DS, Karchmer AW, Sugar AM, Sharkey PK, Wise GJ, Mangi R, Mosher A, Lee JY, Dismukes WE et al (2000) Prospective multicenter surveillance study of funguria in hospitalized patients. *Clin Infect Dis* 30:14–18
- Kobayashi M, Sonobe H, Ikezoe T, Hakoda E, Ohtsuki Y, Taguchi H (1999) In situ detection of *Aspergillus* 18S ribosomal RNA in invasive pulmonary aspergillosis. *Intern Med* 38:563–569

- Kreger BE, Craven DE, Carling PC, McCabe WR (1980) Gram-negative bacteraemia III. Reassessment of etiology, epidemiology and ecology in 612 patients. *Am J Med* 68:332–343
- Kübler A, Durek G, Zamirowska A, Duszyńska W, Palysinska B, Gaszynski W, Pluta A (2004) Severe sepsis in Poland – results of internet surveillance of 1043 cases. *Med Sci Monit* 10:635–641
- Lau A, Sorrell T, Chen S, Stanley K, Iredell J, Halliday C (2008) Multiplex-tandem PCR: a novel platform for the rapid detection and identification of fungal pathogens from blood culture specimens. *J Clin Microbiol* 46:3021–3027
- Lehmann LE, Hunfeld K-P, Emrich T, Haberhausen G, Wissing H, Hoefl A, Stüber F (2008) A multiplex real-time PCR assay for rapid detection and differentiation of 25 bacterial and fungal pathogens from whole blood samples. *Med Microbiol Immunol* 197:313–324
- Levi M, Ten Cate H (1999) Disseminated intravascular coagulation. *N Engl J Med* 341:586–592
- Li J, Bai FY (2007) Single-strand conformation polymorphism of microsatellite for rapid strain typing of *Candida albicans*. *Med Mycol* 45:629–635
- Liu M, Healy MD, Dougherty BA, Esposito KM, Maurice TC, Mazzucco CE, Brucoleri RE, Davison DB, Frosco M, Barrett JF, Wang YK (2006) Conserved fungal genes as potential targets for broad-spectrum antifungal drug discovery. *Eukaryotic Cell* 5:638–649
- Lindsley MD, Hurst SF, Iqbal NJ, Morrison CJ (2001) Rapid identification of dimorphic and yeast-like fungal pathogens using specific DNA probes. *J Clin Microbiol* 39:3505–3511
- Loeffler J, Hebart H, Sepe S, Schumacher U, Klingebiel T, Einsele H (1998) Detection of PCR-amplified fungal DNA by using a PCR ELISA system. *Med Mycol* 36:275–279
- Loeffler J, Henke N, Hebart H, Schmidt D, Hagemeyer L, Schumacher U, Einsele H (2000) Quantification of fungal DNA by using fluorescence resonance energy transfer and the light cycler system. *J Clin Microbiol* 38:586–590
- Loeffler J, Schmidt K, Hebart H, Schumacher U, Einsele H (2002) Automated extraction of genomic DNA from medically important yeast species and filamentous fungi by using the MagNA Pure LC system. *J Clin Microbiol* 40:2240–2243
- Louie RF, Tang Z, Albertson TE, Cohen S, Tran NK, Kost GJ (2008) Multiplex polymerase chain reaction detection enhancement of bacteraemia and fungemia. *Crit Care Med* 36:1487–1492
- Lü PH, Zhao BL, Shi Y, Wen YT (2007) The diagnostic value of detecting plasma 1, 3-beta-D-glucan for invasive fungal infections. *Zhonghua Jie He He Hu Xi Za Zhi* 30:31–34
- Lugert R, Schettler C, Gross U (2006) Comparison of different protocols for DNA preparation and PCR for the detection of fungal pathogens in vitro. *Mycoses* 49:298–304
- Luna CM, Vujacich P, Niederman MS, Vay C, Ghepardy C, Matera J, Jolly EC (1997) Impact of BAL data on the therapy and outcome of ventilator-associated pneumonia. *Chest* 111:676–685
- Mancini N, Clerici D, Diotti R, Perotti M, Ghidoli N, De Marco D, Pizzorno B, Emrich T, Burioni R, Ciceri F, Clementi M (2008) Molecular diagnosis of sepsis in neutropenic patients with haematological malignancies. *J Med Microbiol* 57:601–604
- Mannarelli BM, Kurtzsch CP (1998) Rapid identification of *Candida albicans* and other human pathogenic yeasts by using short oligonucleotides in a PCR. *J Clin Microbiol* 36:1634–1641
- Marr KA (2004) Invasive *Candida* infections: the changing epidemiology. *Oncology (Huntington)* 18:9–14
- Martin GS, Mannino DM (2003) The epidemiology of sepsis in the United States from 1979 through 2000. *NEJM* 348:1546–1554
- Martin C, Roberts D, van der Weide M, Rossau R, Jannes G, Smith T, Maher M (2000) Development of a PCR-based line probe assay for identification of fungal pathogens. *J Clin Microbiol* 38:3735–3742
- Martin GS, Mannino DM, Eaton S, Moss M (2003) The epidemiology of sepsis in the United States from 1979 through 2000. *N Engl J Med* 348:1546–1554
- Meisner M, Tschaikowsky K, Palmaers T, Schmidt J (1999) Comparison of procalcitonin (PCT) and C-reactive protein (CRP) plasma concentrations at different SOFA scores during the course of sepsis and MODS. *Crit Care* 3:45–50
- Metwally L, Fairley DJ, Coyle PV, Hay RJ, Hedderwick S, McCloskey B, O'Neill HJ, Webb CH, Elbaz W, McMullan R (2008) Improving molecular detection of *Candida* DNA in whole

- blood: comparison of seven fungal DNA extraction protocols using real-time PCR. *J Med Microbiol* 57:296–303
- Mikami Y (2008) Proposal of new molecular characterization methods in phylogenetic studies and genotypings of pathogenic fungi. *Nippon Ishinkin Gakkai Zasshi* 49:151–155
- Morrell M, Fraser VJ, Kollef MH (2005) Delaying the empiric treatment of *Candida* bloodstream infection until positive blood culture results are obtained: a potential risk factor for hospital mortality. *Antimicrob Agents Chemother* 49:3640–3645
- Müller FM, Werner KE, Kasai M, Francesconi A, Chanock SJ, Walsh TJ (1998) Rapid extraction of genomic DNA from medically important yeasts and filamentous fungi by high-speed cell disruption. *J Clin Microbiol* 36:1625–1629
- Munson EL, Diekema DJ, Beekmann SE, Chapin KC, Doern GV (2003) Detection and treatment of bloodstream infection: laboratory reporting and antimicrobial management. *J Clin Microbiol* 41:495–497
- Nolla-Salas J, Sitges-Serra A, León-Gil C, Martínez-González J, León-Regidor MA, Ibáñez-Lucía P, Torres-Rodríguez JM (1997) Candidaemia in non-neutropenic critically ill patients: analysis of prognostic factors and assessment of systemic antifungal therapy. Study group of fungal infection in the ICU. *Intensive Care Med* 23:23–30
- Odabasi Z, Mattiuzzi G, Estey E, Kantarjian H, Saeki F, Ridge RJ, Ketchum PA, Finkelman MA, Rex JH, Ostrosky-Zeichner L (2004) Beta-D-glucan as a diagnostic adjunct for invasive fungal infections: validation, cutoff development, and performance in patients with acute myelogenous leukemia and myelodysplastic syndrome. *Clin Infect Dis* 39:199–205
- Opal SM, Esmon CT (2003) Bench-to-bedside review: functional relationships between coagulation and the innate immune response and their respective roles in the pathogenesis of sepsis. *Crit Care* 7:23–38
- Palka-Santini M, Cleven BE, Eichinger L, Krönke M, Krut O (2009) Large scale multiplex PCR improves pathogen detection by DNA microarrays. *BMC Microbiol* 9:1
- Pappas PG, Rex JH, Lee J, Hamill RJ, Larsen RA, Powderly W, Kauffman CA, Hyslop N, Mangino JE, Chapman S, Horowitz HW, Edwards JE, Dismukes WE, for the NIAID Mycoses Study Group (2003) A prospective observational study of candidaemia: epidemiology, therapy, and influences on mortality in hospitalized adult and pediatric patients. *Clin Infect Dis* 37:634–643
- Pettila V, Hynninen M, Takkunen O, Kuusela P, Valtonen M (2002) Predictive value of procalcitonin and interleukin 6 in critically ill patients with suspected sepsis. *Intensive Care Med* 28:1220–1225
- Pfaller MA, Diekema DJ, Rinaldi MG, Barnes R, Hu B, Veselov AV, Tiraboschi N, Nagy E, Gibbs DL, and the Global Antifungal Surveillance Group (2005) Results from the ARTEMIS DISK Global Antifungal Surveillance Study: a 6.5-year analysis of susceptibilities of *Candida* and other yeast species to fluconazole and voriconazole by standardized disk diffusion testing. *J Clin Microbiol* 43:5848–5859
- Pinarbasi E, Elliott J, Hornby DP (1996) Activation of a yeast pseudo DNA methyltransferase by deletion of a single amino acid. *J Mol Biol* 257:804–813
- Povoa P (2002) C-reactive protein: a valuable marker of sepsis. *Intensive Care Med* 28:235–243
- Reichard U, Margraf S, Hube B, Rütchel R (1997) A method for recovery of *Candida albicans* DNA from larger blood samples and its detection by polymerase chain reaction on proteinase genes. *Mycoses* 40:249–253
- Reinhart K, Brunkhorst FM, Bone HG, Gerlach H, Gründling M, Kreymann G, Kujath P, Marggraf G, Mayer K, Meier-Hellmann A, Peckelsen C, Putensen C, Stüber F, Quintel M, Ragaller M, Rossaint R, Weiler N, Welte T, Werdan K (2006) Diagnosis and therapy of sepsis. *Clin Res Cardiol* 95:429–454
- Reiss E, Tanaka K, Bruker G, Chazalet V, Coleman DC, Debeauvais J-P, Hanazawa R, Latgé J-P, Lortholary J, Makimura K, Morrison CJ, Murayama SY, Naoe S, Paris S, Sarfati J, Shibuya K, Sullivan DJ, Uchida K, Yamaguchi H (1998) Molecular diagnosis and epidemiology of fungal infections. *Med Mycol* 36:249–257

- Rello J, Gallego M, Mariscal D, Soñora R, Vallés J (1997) The value of routine microbial investigation in ventilator-associated pneumonia. *Am J Respir Crit Care Med* 156:196–200
- Rex JH, Pfaller MA (2002) Has antifungal susceptibility testing come of age? *Clin Infect Dis* 35:982–989
- Richardson MD, Kokki MH (1999) New perspectives in the diagnosis of systemic fungal infection. *Ann Med* 31:327–335
- Russell PJ, Welsch JA, Rachlin EM, McCloskey JA (1987) Different levels of DNA methylation in yeast and mycelial forms of *Candida albicans*. *J Bacteriol* 169:4393–4395
- Sachse S, Straube E, Lehmann M, Bauer M, Rußwurm S, Schmidt K-H (2009) Truncated hCGBP improves NAT-based detection of bacterial species in human samples. *J Clin Microbiol* 47:1050–1057
- Schmidt U, Pfaffenbach B, Quabeck K, Donhuijsen K (1991) Fungal infections after bone marrow transplantation – an autopsy study. *Mycoses* 34:S33–35
- Schrenzel J (2007) Clinical relevance of new diagnostic methods for bloodstream infections. *Int J Antimicrob Agents* 30:S2–6
- Sendid B, Caillot D, Baccouch-Humbert B, Klingspor L, Grandjean M, Bonnin A, Poulain D (2003) Contribution of the Platelia *Candida*-specific antibody and antigen tests to early diagnosis of systemic *Candida tropicalis* infection in neutropenic adults. *J Clin Microbiol* 41:4551–4558
- Shin JH, Nolte FS, Morrison CJ (1997) Rapid identification of *Candida* species in blood cultures by a clinically useful PCR method. *J Clin Microbiol* 35:1454–1459
- Shin JH, Nolte FS, Holloway BP, Morrison CJ (1999) Rapid identification of up to three *Candida* species in a single reaction tube by a 5' exonuclease assay using fluorescent DNA probes. *J Clin Microbiol* 37:165–170
- Skladny H, Buchheidt D, Baust C, Krieg-Schneider F, Seifarth W, Leib-Mosch C, Hehlmann R (1999) Specific detection of *Aspergillus* species in blood and bronchoalveolar lavage samples of immunocompromised patients by two-step PCR. *J Clin Microbiol* 37:3865–3871
- Slade E, Tamber PS, Vincent JL (2003) The surviving sepsis campaign: raising awareness to reduce mortality. *Crit Care* 7:1–2
- Spieß B, Seifarth W, Hummel M, Frank O, Fabarius A, Zheng C, Mörz H, Hehlmann R, Buchheidt D (2007) DNA microarray-based detection and identification of fungal pathogens in clinical samples from neutropenic patients. *J Clin Microbiol* 45:3743–3753
- Stefan P, Vazquez JA, Boikov D, Xu C, Sobel JD, Akins RA (1997) Identification of *Candida* species by randomly amplified polymorphic DNA fingerprinting of colony lysates. *J Clin Microbiol* 35:2031–2039
- Styers D, Sheehan DJ, Hogan P, Sahm DF (2006) Laboratory-based surveillance of current antimicrobial resistance patterns and trends among *Staphylococcus aureus*: 2005 status in the United States. *Ann Clin Microbiol Antimicrob* 5:2
- Turenne CY, Sanche SE, Hoban DJ, Karlowsky JA, Kabani AM (1999) Rapid identification of fungi by using the ITS2 genetic region and an automated fluorescent capillary electrophoresis system. *J Clin Microbiol* 37:1846–1851
- Turin L, Riva F, Galbiati G, Cainelli T (2000) Fast, simple and highly sensitive double-rounded polymerase chain reaction assay to detect medically relevant fungi in dermatological specimens. *Eur J Clin Invest* 30:511–518
- Vallés J, Rello J, Ochagavía A, Garnacho J, Alcali MA (2003) Community-acquired blood-stream infection in critically ill adult patients: impact of shock and inappropriate antibiotic therapy on survival. *Chest* 123:1615–1624
- van Burik J-A, Myerson D, Schreckhise RW, Bowden RA (1998) Panfungal PCR assay for detection of fungal infection in human blood specimens. *J Clin Microbiol* 36:1169–1175
- Velegraki A, Kambouris ME, Skiniotis G, Savala M, Mitroussia-Ziouva A, Legakis NJ (1999) Identification of medically significant fungal genera by polymerase chain reaction followed by restriction enzyme analysis. *FEMS Immunol Med Microbiol* 23:303–312
- Vincent JL, Anaissie E, Bruining H, Demajo W, El-Ebiary M, Haber J, Hiramatsu Y, Nitenberg G, Nystrom PO, Pittet D, Rogers T, Sandven P, Sganga G, Shaller MD, Solomkin J (1998)



- Epidemiology, diagnosis and treatment of systemic *Candida* infection in surgical patients under intensive care. *Intensive Care Med* 24:206–216
- Vincent JL, Sakr Y, Sprung CL, Ranieri VM, Reinhart K, Gerlach H, Moreno R, Carlet J, Le Gall JR, Payen D (2006) Sepsis in European intensive care units: results of the SOAP study. *Crit Care Med* 34:344–353
- Wahyuningsih R, Freisleben HJ, Sonntag H-G, Schnitzler P (2000) Simple and rapid detection of *Candida albicans* DNA in serum by PCR for diagnosis of invasive candidiasis. *J Clin Microbiol* 38:3016–3021
- Walsh TJ, Merz WG, Lee JW, Schaufele R, Sein T, Whitcomb PO, Ruddel M, Burns W, Wingard JR, Switchenko AC et al (1995) Diagnosis and therapeutic monitoring of invasive candidiasis by rapid enzymatic detection of serum D-arabinitol. *Am J Med* 99:164–172
- Walsh TJ, Chanock SJ (1998) Diagnosis of invasive fungal infections: advances in nonculture systems. *Curr Clin Top Infect Dis* 18:101–153
- Weinstein MP (2003) Blood culture contamination: persisting problems and partial progress. *Clin Microbiol* 41:2275–2278
- Wellinghausen N, Wirths B, Essig A, Wassill L (2004) Evaluation of the Hyplex BloodScreen Multiplex PCR-Enzyme-linked immunosorbent assay system for direct identification of gram-positive cocci and gram-negative bacilli from positive blood cultures. *J Clin Microbiol* 42:3147–3152
- Wey SB, Mori M, Pfaller MA, Woolson RF, Wenzel RP (1988) Hospital-acquired candidaemia. The attributable mortality and excess length of stay. *Arch Intern Med* 148:2642–2645
- White PL, Shetty A, Barnes RA (2003) Detection of seven *Candida* species using the Light-Cycler system. *J Med Microbiol* 52:229–238
- White PL, Williams DW, Kuriyama T, Samad SA, Lewis MA, Barnes RA (2004) Detection of *Candida* in concentrated oral rinse cultures by real-time PCR. *J Clin Microbiol* 42:2101–2107
- Wiesinger-Mayr H, Vierlinger K, Pichler R, Kriegner A, Hirschl AM, Presterl E, Bodrossy L, Noehammer C (2007) Identification of human pathogens isolated from blood using microarray hybridisation and signal pattern recognition. *BMC Microbiol* 7:78
- Wilkinson CR, Bartlett R, Nurse P, Bird AP (1995) The fission yeast gene *pmt1+* encodes a DNA methyltransferase homologue. *Nucleic Acids Res* 23:203–210
- Wingard JR (2005) The changing face of invasive fungal infections in hematopoietic cell transplant recipients. *Curr Opin Oncol* 17:89–92
- Wingard JR (1995) Importance of *Candida* species other than *C. albicans* as pathogens in oncology. *Clin Infect Dis* 20:115–125
- Wong SF, Mak JW, Pook PC (2007) New mechanical disruption method for extraction of whole cell protein from *Candida albicans*. *Southeast Asian J Trop Med Public Health* 38:512–518
- Yeo SF, Wong B (2002) Current status of nonculture methods for diagnosis of invasive fungal infections. *Clin Microbiol Rev* 15:465–484
- Yong PV, Chong PP, Lau LY, Yeoh RS, Jamal F (2008) Molecular identification of *Candida orthopsilosis* isolated from blood culture. *Mycopathologia* 165:81–87

# Chapter 16

## Classification of Yeasts of the Genus *Malassezia* by Sequencing of the ITS and D1/D2 Regions of DNA

Lidia Pérez-Pérez, Manuel Pereiro, and Jaime Toribio

**Abstract** Yeasts of the genus *Malassezia* are known commensals of human beings and warm-blooded animals. Currently, they are considered emergent pathogen yeasts and have been described as causative agents of systemic opportunistic infections. An accurate identification of *Malassezia* spp. is of relevance to determine the role each species plays in the development of cutaneous and systemic infections. The taxonomy of *Malassezia* spp. has been a matter of discussion since the creation of the genus by Baillon in 1889. The recent development of molecular techniques has improved the classification of this genus, allowing a more accurate differentiation among different species. The taxonomic status is still under expansion, some new species have been appended recently and more will be probably added in the near future. However, descriptions of new species should be done in a standardized manner, including phenotypic and molecular features.

We describe the current classification of *Malassezia* spp. yeasts based on the study and sequencing of ITS and D1/D2 gene of the rDNA and highlight the importance of these regions of the DNA as an easy tool for the identification of this genus.

### 16.1 Introduction

*Malassezia* spp. is a common member of the skin flora which can become a pathogenic element after changes in the cutaneous microclimate. It has been implicated in the ethiopathogenic mechanisms of different skin diseases. Yeasts of the genus *Malassezia* have been classically identified by physiological tests

---

L. Pérez-Pérez

Department of Dermatology, University Hospital Complex of Vigo, C/Porriño 5, 36209 Vigo, Spain

e-mail: lidiacomba@yahoo.es

M. Pereiro and J. Toribio

Department of Dermatology, Laboratory of Mycology, Faculty of Medicine, University Hospital Complex of Santiago de Compostela, C/ San Francisco S/N, 15706 Santiago de Compostela, Spain

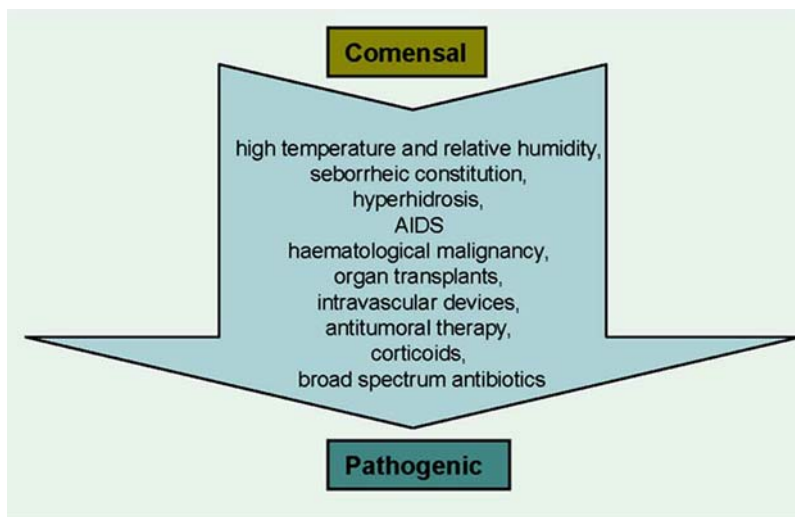
(Kaneko et al. 2007), which allow the identification of some but not all the *Malassezia* species recognized nowadays. The development of a range of molecular techniques based on the study of particular genes has been a definite step in the pathway of fungal identification (Gupta et al. 2004a; Canteros et al. 2007). They provide a more accurate identification, detecting slight differences and are also a very useful tool in the study of the taxonomy of the genus. They are also of great value in the understanding of the phylogenetic relationships and the analysis of the specific genetic variation of the species. The taxonomy and classification of the genus *Malassezia* are currently being updated and they will be probably enlarged with some other species in the near future. We present the classification of *Malassezia* spp. according to the sequencing of the D1/D2 domain and ITS regions of DNA and discuss the value of the novel molecular techniques as identification tools.

## 16.2 Description of the Article

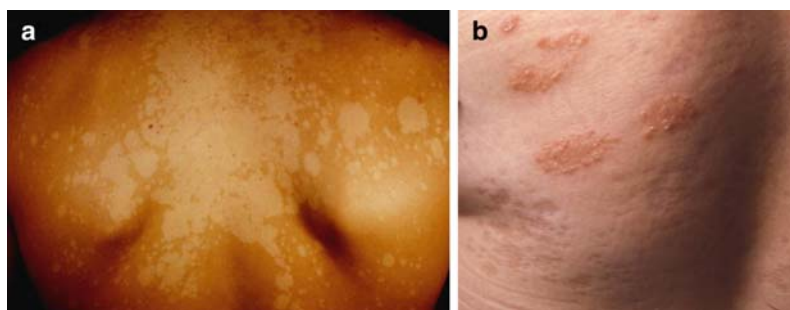
### 16.2.1 Clinical Relevance of the Genus *Malassezia*

Over the last few years, the implication of different yeasts in the development of many diseases in humans has become very relevant, particularly in some subgroups such as immunocompromised patients who may suffer from life-threatening widespread and severe infections. *Malassezia* spp. is a known commensal of warm-blooded animals (including bears, monkeys, pigs, elephants, birds, horses, dogs, goats, sheep, cows, etc) and humans, mainly colonizing areas with a high density of sebaceous glands (scalp, face, ears, back, and chest). However, it can become a pathogenic agent under certain circumstances (Fig.16.1) such as high temperature and relative humidity, seborrhoeic constitution, hyperhidrosis, AIDS (Acquired Immunodeficiency Syndrome), hematological malignancy, organ transplants, intravascular devices, antitumoral therapy, corticoids, and broad spectrum antibiotics (Gupta et al. 2000, 2004b).

The most common disease related to *Malassezia* spp. is pityriasis versicolor (Okuda et al. 1998; Crespo-Erchiga et al. 1999; Pereiro-Miguens 1999; Crespo et al. 2000a; Prohic and Ozegovic 2006; Krisanty et al. 2009) (Fig.16.2), which clinically manifests as multiple brownish, pinkish or whitish plaques with a mild desquamation that usually appear on areas rich in sebaceous glands. Some studies have suggested that *M. globosa* is the main causative agent of pityriasis versicolor (Crespo et al. 2000a); however, others have found *M. furfur* and *M. sympodialis* to be the most common species isolated in patients with this disease (Krisanty et al. 2009). *Malassezia* spp. may also play a role in the development of a number of skin diseases including pityriasis capitis, folliculitis, atopic dermatitis (Sugita et al. 2001, 2003b; Sandström et al. 2005) (Fig.16.3), seborrhoeic dermatitis (Gaitanis et al. 2006b; Prohic 2009), seborrhoeic blepharitis, confluent and reticulate papillomatosis (Gougerot and Carteaud syndrome) (Fig.16.4), transient acantholytic dermatosis, acne, psoriasis (Paulino et al. 2006; Ashbee 2006) (Fig.16.4), nodular



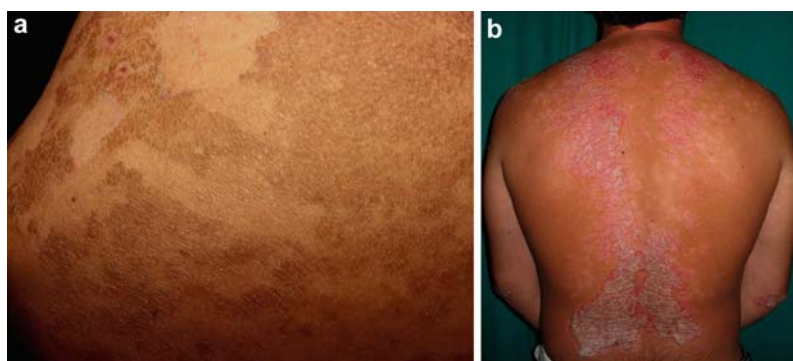
**Fig. 16.1** Factors that can contribute to the pathogenic transformation of *Malassezia* spp



**Fig. 16.2** (a) Typical clinical appearance of pityriasis versicolor, with whitish macules on a male patient's back. (b) A typical presentation of pityriasis versicolor, with atrophic patches and coexisting folliculitis on a female patient's back

hair infections, and onychomycosis (Gupta et al. 2004b). Midgley demonstrated that 72.5% of patients with seborrhoeic dermatitis showed precipitating antibodies to *M. globosa* (Midgley 2000). Crespo et al established that *M. restricta* and *M. globosa* were the most common species isolated from 75 patients with seborrhoeic dermatitis (Crespo et al. 2000a). Folliculitis due to *Malassezia* spp. is a chronic process characterized by the presence of small pruritic follicular papules and pustules mainly distributed on the trunk and upper extremities. The role of *Malassezia* spp. in the development of atopic dermatitis is controversial. Some authorities have suggested that these yeasts might act as allergens mainly in those patients with lesions on their face and neck (Faergemann 1999). Confluent and reticulated

**Fig. 16.3** Atopic eczema on a male patient's forearm



**Fig. 16.4** (a) Clinical appearance of reticulate papillomatosis of Gougerot and Carteaud on a male patient's back. (b) Typical plaques of psoriasis on a male patient's back

papillomatosis is an uncommon disorder clinically characterized by greyish to brownish papules on the trunk or abdomen. The relevance of the identification of *Malassezia* yeasts in patients with this condition and also in patients with psoriasis is yet unknown. *Malassezia* spp. has also been suggested to play a role in fungal nail disease (Midgley 2000) and has also been identified as the causative agent for different severe extracutaneous diseases (Gueho et al. 1987), particularly in patients with underlying diseases or predisposing factors, such as pneumonia, mastitis, sinusitis, malignant otitis externa, abscesses, meningitis (Ashbee 2007), catheter-related fungaemia (Juncosa Morros et al. 2002), and peritonitis (Aspíroz et al. 1997). *M. furfur* and to a lesser extent *M. pachydermatis* have been implicated in the development of severe systemic disease in neonates. *Malassezia* spp. can also cause many skin diseases in animals such as otitis externa (Crespo et al. 2000b; Hirai et al. 2004), dermatitis (Cabañes et al. 2005), alopecia, ulcerous lesions, pruritus, and liquenification (Chen and Hill 2005).

## 16.2.2 *The Diagnosis of the Genus Malassezia*

The identification of the genus *Malassezia* and the differentiation among species have been classically made on the basis of phenotypical and physiological features (Table 16.1) such as the morphology of the colonies, size and shape of the cells (Fig.16.5), and nutritional requirements (Guillot et al. 1996; Kaneko et al. 2007). The macroscopic appearance of the colonies varies among the species. The colonies are generally small, creamy to yellowish in color, with a smooth or rough surface (Fig.16.6) and are composed of rounded, cylindrical or oval cells (Gueho et al. 1996). A characteristic physiological feature of these yeasts is their lipid-dependency, which may vary among the species. The lipid-dependent species need long chain fatty acids to grow; meanwhile those non lipid-dependent species may grow in common culture media containing short chain fatty acids. Except for *M. pachydermatis*, yeasts of the genus *Malassezia* are all lipid-dependent. However, different authors have described isolates of *M. pachydermatis*, phenotypically identified as lipid-dependent, this fact still being a matter of controversy. (Cafarchia et al. 2007). Some authorities have suggested it would be the result of a process of differentiation or adaptation to a particular host. The lipid-dependent species are usually isolated from human skin whereas *M. pachydermatis* has been isolated mainly from birds and mammals. The former have been associated with several diseases and the latter causes chronic dermatitis and otitis externa in animals and also nosocomial infection in humans (Cafarchia et al. 2007). Other physiological features comprise the catalase reaction, assimilation of different polyethylenesorbitane esters (Tween 20, 40, 60, 80), enzymatic activity (esterase, esterase-lipase, N-phosphohydrolase, acid phosphatase, alkaline phosphatase, phospholipase (Cafarchia et al. 2008)), and tolerance to temperature. Guillot et al developed a physiologic algorithm for the identification of *Malassezia* species based on lipid assimilation and other phenotypic features (Guillot et al. 1996). Kaneko et al. developed a culture-based system for the identification of *Malassezia* species which allowed an easy identification of nine different species (particularly *M. furfur*, *M. globosa* and *M. restricta*) with a rate of concordance with molecular analysis of 98.1% (Kaneko et al. 2007). The atypical assimilation of Tween 80 has been recently found to be of interest for the identification of *M. furfur* (González et al. 2009).

These physiological tests, however, present some limitations and difficulties: they are time-consuming, their results are variable, and sometimes display an inadequate taxonomic value. The classical methods do not allow a certain identification of all the species and thus are not enough for classification purposes.

## 16.2.3 *Current State of the Classification of Malassezia spp.*

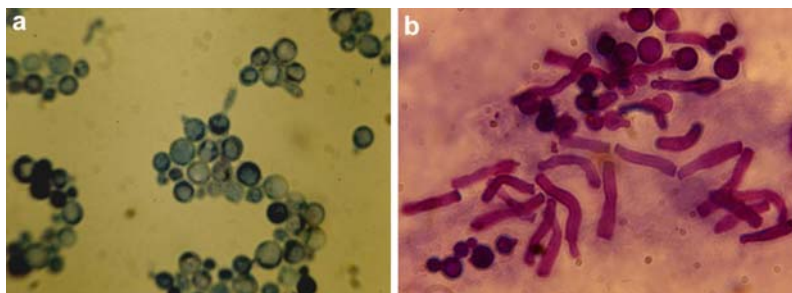
Until 1990, only three species of *Malassezia* were recognized, *M. furfur* (Robin) Baillon, *M. pachydermatis* (Weidman) Dodge, and *M. sympodialis*

**Table 16.1** Physiological characteristics of the main *Malassezia* species: 1 = *M. furfur*; 2 = *M. pachydermatis*; 3 = *M. sympodialis*; 4 = *M. globosa*; 5 = *M. obtusa*; 6 = *M. restricta*; 7 = *M. slooffiae*; 8 = *M. dermatis*; 9 = *M. nana*; 10 = *M. japonica*; 11 = *M. yamatoensis*. (Guillot et al. 1996; Hirai et al. 2004; Sugita et al. 2003b)

Features	1	2	3	4	5	6	7	8	9	10	11
Culture in Sabouraud medium at 32°C (no lipid supplementation)	-	+	-	-	-	-	-	-	-	-	-
Culture in Dixon medium at 40°C	+	+	+	-	-	-	+	+	+/-	-	-
Catalase reaction	+	+/-	+	+	+	-	+	+	+	+	+
Lipid assimilation:	+	-	-	-	-	-	+/-	+	+/-	-	-
- Tween 20 (10%)	+	+	+	-	-	-	+	+	+	+/-	+/-
- Tween 40 or 60 (0.5%)	+	+	+	-	-	-	-	+	+	-	-
- Tween 80 (0.1%)	+	V <sup>a</sup>	+	-	-	-	-	+	+/-	-	-
- Cremophor EL	+	-	-	-	-	-	-	+	-	NT <sup>b</sup>	-
Esculine hydrolysis	-	V	+	-	+	-	-	-	-	NT	NT
Precipitate in Dixon medium	-	NT	+	+	-	NT	-	+	+	NT	NT

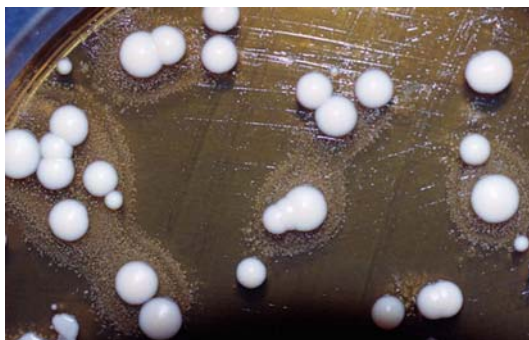
<sup>a</sup>V-variable

<sup>b</sup>NT-not tested



**Fig. 16.5** Shape of *Malassezia globosa* cells

**Fig. 16.6** Small, whitish and creamy colonies of *Malassezia pachydermatis*



(Simmons and Guého) (Gupta et al. 2000). In 1996, Guého et al updated the genus *Malassezia* according to morphologic, ultrastructural, physiologic, and molecular criteria and established a new classification comprising seven well-defined species (Gueho et al. 1996). Recently, on the basis of genetic studies of a number of different isolates from humans and animals, four new species have been suggested or proposed: *M. dermatis* (Sugita et al. 2002), *M. nana* (Hirai et al. 2004), *M. japonica* (Sugita et al. 2003b), and *M. yamatoensis* (Sugita et al. 2004) (Table 16.2). Nell et al. isolated a new species from horses, *M. equi*, which has not been formally recognized (Nell et al. 2002), as its description was not provided and there is not any type specimen currently available. Cabañes et al recently described two new lipid-dependent species named *Malassezia caprae* sp. nov. and *Malassezia equina* sp. nov., isolated from healthy goats and horses, respectively (Cabañes et al 2007). These species seem to be closely related to *M. sympodialis*, *M. Dermatis*, and *M. nana*. *M. equina*, *M. caprae*, *M. Nana*, and *M. pachydermatis* are associated with animals; the remaining species are part of the normal human flora and are also associated with human pathologies (González et al. 2009).

Several molecular techniques have been introduced recently in the field of mycology for the study and identification of fungi. Those applied to study the genus *Malassezia* include RADP (Random amplification of polymorphic DNA)



**Table 16.2** Currently accepted and proposed *Malassezia* species

<i>Malassezia</i> species	Author, year
<i>M. furfur</i>	(Robin) Baillon (1889)
<i>M. pachydermatis</i>	(Weidman) Dodge (1935)
<i>M. sympodialis</i>	Simmons and Guého (1990)
<i>M. globosa</i>	Midgley et al. (1996)
<i>M. slooffiae</i>	Guillot et al. (1996)
<i>M. obtusa</i>	Gueho et al. (1996)
<i>M. restricta</i>	Gueho et al. (1996)
<i>M. dermatis</i>	Sugita et al. (2002)
<i>M. japonica</i>	Sugita et al. (2003)
<i>M. nana</i>	Hirai et al. (2004)
<i>M. yamatoensis</i>	Sugita et al. (2004)
<i>M. caprae sp nov</i>	Cabañes et al. (2007)
<i>M. equina sp nov</i>	Cabañes et al. (2007)

(Castellá et al. 2005; Hossain et al. 2007), PFGE (pulsed-field gel electrophoresis) (Boekhout et al. 1998), sequencing of the chitin synthase 2 gene (Kano et al. 1999), sequencing of the large subunit of mitochondrial rRNA (Yamada et al. 2003), AFLP (Amplified Length polymorphisms) (Gupta et al. 2004a), PCR of the LSU of the rRNA and digestion with restriction enzymes (Guillot et al. 2000), multiplex-real time PCR (Paulino et al. 2008), PCR-REA (Polymerase Chain Reaction and Restriction Enzyme Analysis) (Giusiano et al. 2003), DGGE (denaturing gradient gel electrophoresis) (Theelen et al. 2001), RFLP (restriction fragment polymorphisms) (Mirhendi et al. 2005), sequencing of the LSU of the rDNA or the ITS region (Sugita et al. 2003a; Cafarchia et al. 2007). The most recent method developed for the identification of *Malassezia* spp. is a bead suspension array that uses species and group specific probes analyzed by flow cytometry (Díaz et al. 2006). Cafarchia et al suggested the use of multilocus sequencing for the identification of and differentiation among species or genotypes which are phenotypically difficult to characterize (Cafarchia et al. 2007). Gaitanis et al published recently an interesting and detailed review on the methodology for *Malassezia* typing, distinguishing two main groups of techniques: those focused on targeted PCR amplifications of selected sequences and subsequent search of mutations and random PCR-amplification of polymorphic DNA or redundant sequences within the genome (Gaitanis et al. 2009). Most of these methods are expensive and time consuming. In contrast, PCR techniques are easy to perform and provide a rapid identification of *Malassezia* species (Affes et al. 2008).

Sequencing of the D1/D2 domain and the ITS regions (Gaitanis et al. 2006a; Makimura et al. 2000) of the DNA is a useful and accurate procedure for the identification and classification of different fungi (Abliz et al. 2004; León-Mateos et al. 2006). The rDNA genes of *Malassezia* spp. are constituted by the 5S, 5.8S, 18S (small), and 26S (large) subunits (Fig.16.7). There are other two regions inserted between the subunits: the ITS region (Internal Transcriber Spacer) and the IGS region (Intergenic Spacer). Both of them are divided into two subregions. The D1/D2 region of the DNA which encodes for the ribosomal large subunit (LSUrDNA) is located in the 5' end of the large subunit (26S) of the ribosomal

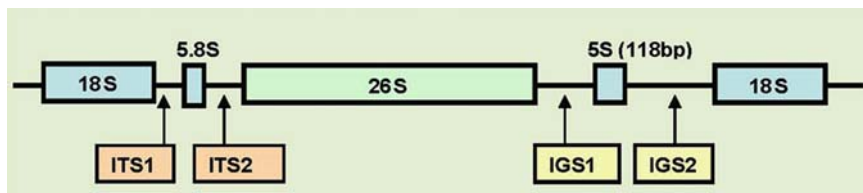


Fig. 16.7 Structure of the rDNA gene of *Malassezia* spp

DNA (Sugita et al. 2003a). These regions are highly conserved in a particular species and vary among different species. rDNA is a multicopy gene that includes several regions not encoding for proteins: ITS 1, ITS 2, and IGS, which are highly conserved regions.

The D1/D2 region of the DNA encoding for the ribosomal large subunit (LSUrDNA) is currently considered very useful for the identification of the vast majority of fungi of medical relevance (Kurtzman and Robnett 1997; Fell et al. 2000). Most of the species can be identified by analysis of the D1/D2 domain. In fact, no other genetic region with a higher ability to discriminate species has been described to date (Abliz et al 2004). However, the study of closely related species or strains requires sequencing of the ITS region (Cabañes et al. 2005).

The sequencing of the ITS regions and D1/D2 domain and subsequent studies of the sequences obtained showed that the phylogenetic trees constructed with the ITS region sequencing matched those obtained with D1/D2 domain sequencing (Gupta et al. 2004a). This method allows an accurate identification and differentiation of the current *Malassezia* species, which appear in the trees grouped in different clusters. Small differences among strains from the same species can be found sometimes and thus a particular species can be considered in terms of a “species complex.”

Our group (Laboratory of Mycology, Department of Dermatology, Faculty of Medicine, Santiago de Compostela) conducted studies on the D1/D2 and ITS regions of isolates from different species of *Malassezia*, in an attempt to analyze their phylogenetic relations (unpublished data). We studied a total of 28 strains from six different species of the genus *Malassezia* (*M. pachydermatis*, *M. sympodialis*, *M. furfur*, *M. restricta*, *M. globosa*, *M. sloffiae*) (Table 16.3). These isolates were collected from dogs, pigs, healthy subjects, and patients with pityriasis versicolor and were part of a 63-strain collection previously used by our group to carry out a study on the LSU and ITS regions (unpublished data).

The strains were cultured in Saboraud and modified Dixon’s media supplemented with cycloheximida and chloramfenicol following standard procedures and were first identified on the basis of their phenotypic and physiological features. DNA extraction was subsequently performed as described by Hillis (Hillis et al. 1996), after digestion of the cellular wall. The ITS region and D1/D2 domain were amplified by PCR using respectively the fungal oligonucleotides (ITS-5, ITS-2, ITS-3, ITS-4) and (NL-1, NL-2, NL-3, NL-4) (Table 16.4) synthesized by Sigma

**Table 16.3** Details of the strains sequenced in our study

Origin	Strain	Code
Animal, pig	<i>M. furfur</i> 26	MFU01
Animal, pig	<i>M. furfur</i> 28	MFU02
Animal, dog	<i>M. pachydermatis</i> 4	MPA03
Animal, dog	<i>M. pachydermatis</i> 6	MPA04
Animal, dog	<i>M. pachydermatis</i> 10	MPA05
Animal, dog	<i>M. pachydermatis</i> 34LD	MPA06
Animal, dog	<i>M. pachydermatis</i> 21	MPA07
Animal, dog	<i>M. pachydermatis</i> 75LD	MPA08
Animal, dog	<i>M. pachydermatis</i> 13LD	MPA09
Animal, dog	<i>M. pachydermatis</i> 11	MPA10
Animal, dog	<i>M. pachydermatis</i> 75	MPA11
Animal, dog	<i>M. pachydermatis</i> 107LD	MPA12
Animal, pig	<i>M. sympodialis</i> 12A	MSY13
Animal, pig	<i>M. sympodialis</i> 13A	MSY14
Animal, pig	<i>M. sympodialis</i> 20	MSY15
Animal, pig	<i>M. sympodialis</i> 21	MSY16
Animal, pig	<i>M. sympodialis</i> 22A	MSY17
Animal, pig	<i>M. sympodialis</i> 25A	MSY18
Human	<i>M. sympodialis</i> 01022043	MSY19
Human	<i>M. sympodialis</i> 043943B	MSY20
Human	<i>M. sympodialis</i> 039371A	MSY21
Animal, pig	<i>M. sympodialis</i> 17A	MSY22
Animal, pig	<i>M. sympodialis</i> 32A	MSY23
Human	<i>M. sympodialis</i> CBS 7222	MSY24
Human	<i>M. globosa</i> 01034998	MGL25
Human	<i>M. globosa</i> 010425748	MGL26
Human	<i>M. restricta</i> VCA 585	MRE27
Animal, pig	<i>M. slooffiae</i> 3A	MSL28

**Table 16.4** Primers used for the amplification of the D1/D2 domain and the ITS regions of *Malassezia* spp

Region	Primer	Sequence (5'–3')	Tm (°C)
D1/D2	NL-1	gca tat caa taa gcg gag gaa aag	65/33
	NL-4 m	ggt ccg tgt ttc aag acg	61/79
ITS	ITS1	tcc gta ggt gaa ccg cgc	65
	ITS5	gga agt aaa gtc gta aca agg	63
	ITS2	gct gcg ttc ttc atc gat gc	62
	ITS3	gca tcg atg aag aac gca gc	62
	ITS4	tcc tcc gct tat tga tat gc	58

Genosys labs (Sigma Genosys Ltd, Sigma-Aldrich House, Haverhill, UK). These primers had already been successfully used in previous studies of these regions (Hirai et al. 2002; Sugita et al. 2002, 2003a; Martin and Rygiewicz 2005; Cabañes et al. 2005). We extracted a number of sequences of different *Malassezia* species from the Genbank database (Table 16.5) with comparative purposes and to study their phylogeny.

**Table 16.5** Sequences extracted from the GenBank database and their accession numbers

Species	Strain	D1/D2 domain accession number	ITS region accession number
<i>M. sympodialis</i>	WBC2	AY 387254	–
	LMB3	AY 387268	–
	KEB1	AY 387271	–
	JF05	AY 387276	–
	98F	AY 387291	–
	MA231	AY 743609	AY743648
	MA80.CBS9967	AY 743618	AY743647
	MA125	AY 743619	AY743646
	MA73.CBS9968	AY 743627	AY743640
	MA 477	AY 743628	AY743639
	MA88CBS9986	–	AY743645
<i>M. pachydermatis</i>	MA419	–	AY743653
	GENOTYPE A	DQ915500	–
	GENOTYPE B	DQ915501	–
	GENOTYPE C1	DQ915502	–
	CBS1879	AY387235	–
	CBS1919	AY387236	–
	CBS1885	AY387237	–
	CBS1884	AY387238	–
	CBS1879	AY743605	AY743637
	AFTOL-ID856	AY745724	–
	CBS1879	AJ249952	–
	CBS1879	–	AB118941
	IFM52772	–	AB118939
	IFM52748	–	AB118940
	IFM52755	–	AB118937
<i>M. furfur</i>	CBS1878	AY743602	AY743634
	CBS7019	AY743603	AY743635
	CBS1878	AY387196	–
<i>M. yamatoensis</i>	M9985	AB12563	AB125261
	M9986	AB12564	–
<i>M. japonica</i>	CBS9431	EF140672	–
	M9976	AB105199	AB105199
<i>M. slooffiae</i>	CBS7956	AY743606	AY743633
		AJ249956	–
<i>M. globosa</i>	TV1	AY387249	–
	CBS7966	AJ249951	–
		AY387228	–
<i>M. restricta</i>		AY743604	AY743630
	CBS7877	AJ249950	–
		AY387239	–
<i>M. obtusa</i>		AY743607	AY743636
	CBS7876	AY743629	AY743631
	CBS7968	AY387234	–
<i>M. dermatis</i>	M9927	AB070361	AB070356
	M9930	AB070364	–

The sequences obtained were analyzed with the software DNAsis, CLC Free Workbench v. 4.0.2 and MEGA version 3.1 (Kumar et al 2004). The clustal alignment of our sequences and those extracted from the GenBank database was performed with the software CLC Free Workbench v.4.0.2. Subsequent comparative studies of the sequences obtained were conducted to analyze inter and intra-species dissimilarities. The MEGA package, version 3.1, was used to perform a maximum parsimony analysis with 1,000 bootstrap replicates.

The molecular phylogenetic trees of the ITS and D1/D2 regions of the 26s rRNA gene sequences were constructed with MEGA v3.1 using the maximum parsimony method.

The D1/D2 domain tree in Fig. 16.8 shows four well-defined phylogenetic clusters: cluster I comprises *M. sympodialis* strains, which seem to be closely related to *M. dermatis* strains and display intraspecies diversity. Strains of *M. sympodialis* from animals and humans tend to appear grouped in the tree. Cluster II includes *M. obtusa*, *M. yamatoensis*, *M. Japonica*, and *M. furfur*. *M. yamatoensis* and *M. japonica* are both from human origin and appear classified within the same subcluster. All the *M. pachydermatis* strains were isolated from animals (dogs) and are grouped in cluster III. The vast majority of our strains are grouped together, closely related to those from the GenBank database. Cluster IV includes *M. globosa*, *M. Restricta*, and *M. slooffiae*, which are clearly separated into three independent subgroups.

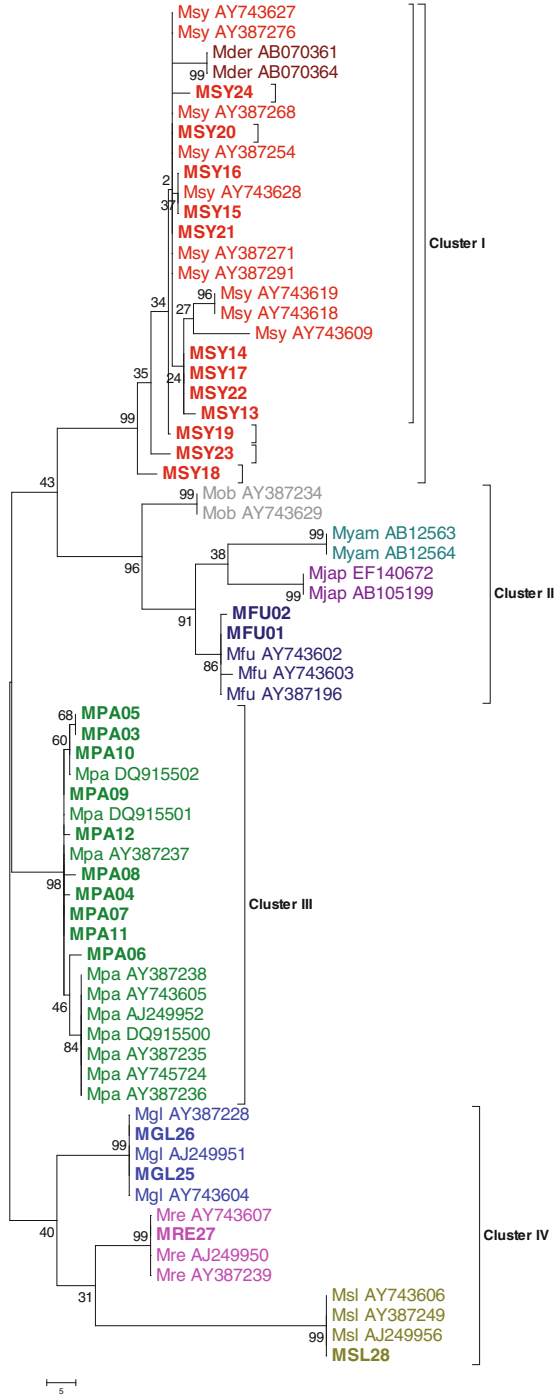
The phylogenetic tree constructed with the sequences of the ITS region of our strains and those selected from the GenBank database is shown in Fig. 16.9. As it occurs with the tree obtained with the D1/D2 domain sequences, four main clusters are identified: cluster I includes *M. sympodialis*, *M. Dermatis*, and *M. yamatoensis*; cluster II comprises all the strains of *M. pachydermatis*, which seem to share a common root with *M. sympodialis*. All of them appear grouped together. Cluster III includes strains of *M. japonica*, *M. Obtusa*, and *M. furfur*. *M. slooffiae*, *M. Globosa*, and *M. restricta* constitute cluster IV.

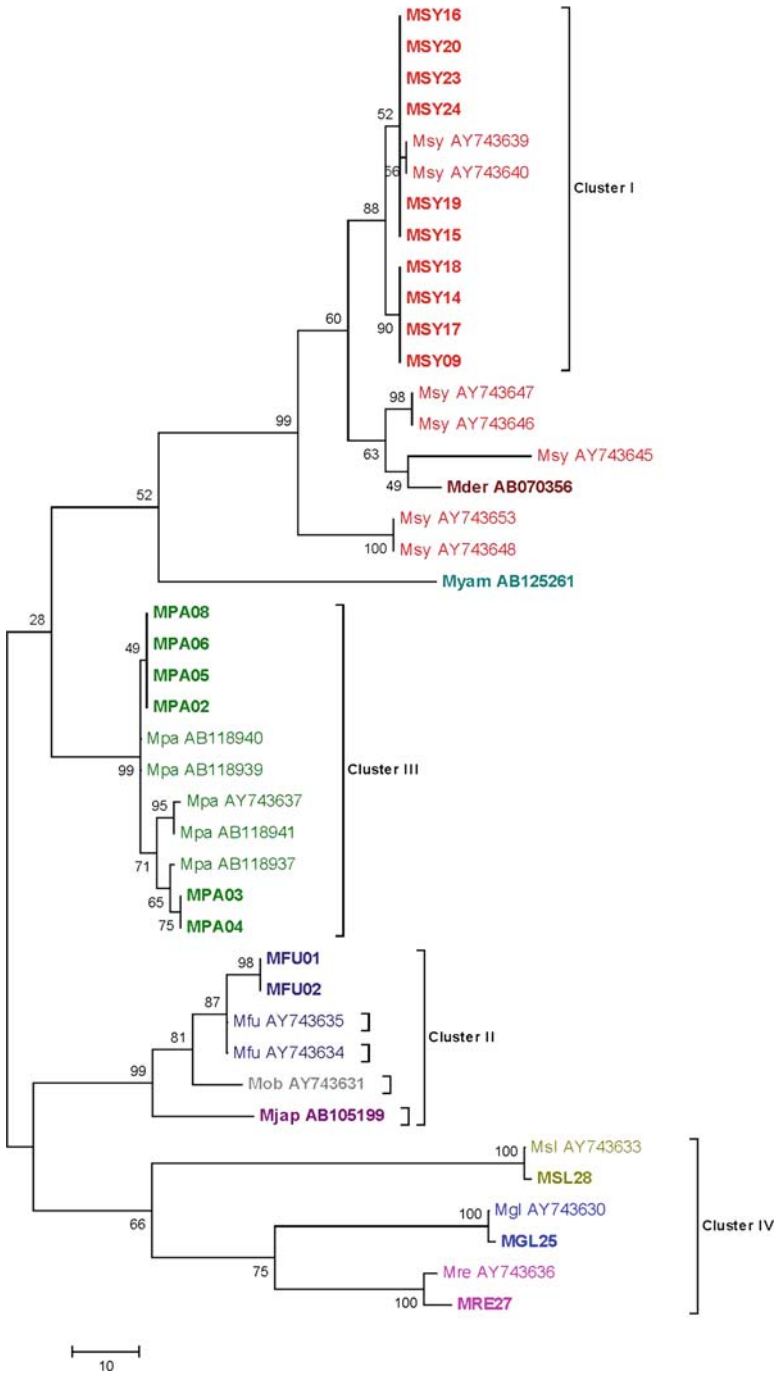
The phylogenetic relationships displayed in the trees constructed with the sequences of ITS and D1/D2 regions are very similar.

### 16.3 Conclusions and Future Line of Investigation

The molecular methods have provided strong evidence to support the current classification of *Malassezia* spp. and have contributed much to improve the understanding and knowledge of the genus (Gaitanis et al. 2009). However, they present some limitations. Firstly, they need specific equipment and trained staff and are expensive in comparison to the classical methods of identification. Moreover, on clinical grounds, for most routine clinical mycology laboratories there is little need to speciate the isolates recovered from skin samples. Although it is of epidemiological interest to determine the species of *Malassezia* associated with particular

**Fig. 16.8** D1/D2 phylogenetic tree (See text). The numbers at branch points represent the percentages of 1,000 bootstrapped datasets that supported the specific internal branches





**Fig. 16.9** ITS phylogenetic tree (See text). The numbers at branch points represent the percentages of 1,000 bootstrapped datasets that supported the specific internal branches

diseases, this is beyond the scope of most laboratories in a routine clinical setting and thus, most of these methods are used in laboratories for only investigative purposes. Because of the time it takes to culture *Malassezia* and the realization that no single medium can reliably recover all the species, several groups have developed methods for the molecular analysis of fungus directly from the skin without prior culture (Ashbee 2007) or from a range of commercial media used in microbiology laboratories (Pryce et al. 2006). This would be an interesting alternative, as it shortens the identification process and makes it easier.

Anyway, the results obtained by molecular methods should be carefully interpreted under the light of the classical phenotypic methods of identification and clinical findings, as the molecular classification is based on genetic sequences that encode proteins and these are not directly related to the phenotypic characteristics of the species. The current available analyzes study highly conserved regions of the nuclear DNA encoding for the ribosomal subunits. Differences among the sequences obtained seem to overlap with clear phenotypic differences observed among the species. The dissimilarities found in these regions may affect the intergenic spaces, which do not encode for protein (intron) or the spaces encoding for a particular subunit. Intergenic spaces are of high value, as they include transcription regulating regions. Along the evolution of the species, these spaces tend to shorten due to deletions in the sequences and thus it is relatively common to find differences. However, it can be difficult to establish whether these differences merit to be considered a different species or are simply variations of a particular species. The regions encoding for functional proteins (exon) tend to remain conserved and therefore significant differences in them are more difficult to observe. It would also be of interest to analyze in future studies whether the differences among these two regions (intron and exon) are concordant.

We tried to compare sequences of the ITS region and the D1/D2 domain of the same strain, as we thought the comparison between these two regions of the DNA would be stronger. It was not possible to do so with all the strains, as many of them do not have sequences available for both regions in the GenBank database. We consider it would be of interest to enlarge in the future the databases with strains which were sequenced in both the ITS and D1/D2 domain, in order to compare this two regions properly and analyze their relationships.

ITS region and D1/D2 domain are much conserved. Small differences between them are of high relevance, particularly in the D1/D2 domain, as it is more conserved than the ITS region. We consider of interest the classification of the different species on the basis of the sequences of both regions. Some species showed high diversity in the phylogenetic trees, thus suggesting that the existence of close and different species not yet identified might be a strong possibility. We observed that *M pachydermatis* and *M sympodialis* particularly showed higher genetic diversity in the regions we studied and we suggest it would be interesting to run a larger study on these species, as some of the strains currently included may be recognized as new species in the future.

A deeper knowledge of all the *Malassezia* species and their biology is not only necessary to fully understand the mechanism of many skin diseases, but also to



improve and complement the different treatment options currently available for these disorders.

Uploading new sequences of different species of *Malassezia* in the GenBank database is of great interest in enlarging the number of sequences available for studies in the near future. Larger investigations correlating the molecular dissimilarities among species and their phenotypical and biological characteristics are the key to fully understand the real meaning of the findings in the molecular methods and their impact in the daily routine.

### Acknowledgments

We are very grateful to

- Dr. Carmen Paredes Suárez (Dermatology Unit; Hospital Virxe da Xunqueira, Cee, Spain), who kindly provided her personal data on the restriction enzyme analysis of the ITS region.
- Dr Álvaro León Mateos (Department of Dermatology; Hospital POVISA, Vigo, Spain) for his advise on the writing of this manuscript.
- Dr. Margarita Garau and Dr Amalia del Palacio (Department of Microbiology; Hospital 12 de Octubre, Madrid, Spain), for providing some of the strains for our study.
- Dr. Gillian Midgley (Department of Medical Mycology, St John's Institute of Dermatology, St Thomas' Hospital, London, UK) for her disinterested contribution to the understanding of the genus *Malassezia*.

This study was supported by the grant PGIDT01PX120810PR from the Local Government of Galicia, Spain.

### References

- Abliz P, Fukushima K, Takizawa K, Nishimura K (2004) Identification of pathogenic dematiaceous fungi and related taxa based on large subunit ribosomal DNA D1/D2 domain sequence analysis. *FEMS Immunol Med Microbiol* 40:41–49
- Affes M, Ben Salah S, Makni F, Sellami H, Ayadi A (2008) Molecular identification of *Malassezia* species isolated from dermatitis affections. *Mycoses* 52:251–256
- Ashbee HR (2006) Recent developments in the immunology and biology of *Malassezia* species. *FEMS Immunol Med Microbiol* 47:14–23
- Ashbee HR (2007) Update on the genus *Malassezia*. *Med Mycol* 45:287–303
- Aspíroz MC, Moreno LA, Rubio MC (1997) Taxonomía de *Malassezia furfur*: estado de la cuestión. *Rev Iberoam Micol* 14:147–149
- Boekhout T, Kamp M, Guého E (1998) Molecular typing of *Malassezia* species with PFGE and RAPD. *Med Mycol* 36:365–372
- Cabañes FJ, Hernández JJ, Castellá G (2005) Molecular analysis of *Malassezia sympodialis*-related strains from domestic animals. *J Clin Microbiol* 43:277–283
- Cabañes FJ, Theelen B, Castellá G, Boekhout T (2007) Two new lipid-dependent *Malassezia* species from domestic animals. *FEMS Yeast Res* 7:1064–1076
- Cafarchia C, Latrofa M, Testini G et al (2007) Molecular characterization of *Malassezia* isolates from dogs using three distinct genetic markers in nuclear DNA. *Mol Cell Probes* 21:229–238
- Cafarchia C, Gasser R, Latrofa M, Parisi A, Campbell B, Otranto D (2008) Genetic variants of *Malassezia pachydermatis* from canine skin. Body distribution and phospholipase activity. *FEMS Yeasts Res* 8:451–459

- Canteros CE, Rivas MC, Lee W, Perrotta D, Bosco-Borgeat ME, Davel G (2007) Concordancia entre características fenotípicas y PCR-REA en la identificación de especies de *Malassezia*. Rev Iberoam Micol 24:274–278
- Castellá G, Hernández J, Cabañes J (2005) Genetic typing of *Malassezia pachydermatis* from different domestic animals. Vet Microbiol 108:291–296
- Chen T, Hill PB (2005) The biology of *Malassezia* organisms and their ability to induce immune responses and skin disease. Vet Dermatol 16:4–26
- Crespo-Erchiga V, Ojeda-Martos A, Vera-Casano A, Crespo-Erchiga A, Sánchez-Fajardo F (1999) Aislamiento e identificación de *Malassezia* spp. en pitiriasis versicolor, dermatitis seborreica y piel sana. Rev Iberoam Micol 16:S16–S21
- Crespo V, Ojeda A, Vera A, Crespo A, Sánchez F (2000a) *Malassezia globosa* as the causative agent of pityriasis versicolor. Br J Dermatol 143:799–803
- Crespo M, Abarca M, Cabañes FJ (2000b) Otitis externa associated with *Malassezia sympodialis* in two cats. J Clin Microbiol 38:1263–1266
- Díaz MR, Boekhout T, Theelen B et al (2006) Microcoding and flow cytometry as a high-throughput fungal identification system for *Malassezia* species. J Med Microbiol 55:1197–1209
- Faergemann J (1999) *Pityrosporum* species as a cause of allergy and infection. Allergy 54:93–99
- Fell JW, Boekhout T, Fonseca A, Scorzetti G, Scorzetti G, Stazzell-Tallman A (2000) Biodiversity and systematics of *Basidiomycetous* yeasts as determined by large-subunit rDNA D1/D2 domain sequence analysis. Int J Syst Evol Microbiol 50:1351–1371
- Gaitanis G, Robert V, Velegraki A (2006a) Verifiable single nucleotide polymorphisms of the internal transcribed spacer 2 region for the identification of 11 *Malassezia* species. J Dermatol Sci 43:214–217
- Gaitanis G, Velegraki A, Alexopoulos EC, Chasapi V, Tsigonia A, Katsambas A (2006b) Distribution of *Malassezia* species in pityriasis versicolor and seborrheic dermatitis in Greece. Typing of the major pityriasis versicolor isolate *M. globosa*. Br J Dermatol 154:854–859
- Gaitanis G, Bassukas I, Velegraki A (2009) The range of molecular methods for typing *Malassezia*. Curr Opin Infect Dis 22:119–125
- Giusiano G, Bustillo S, Mangiaterra M, Deluca G (2003) Identificación de especies de *Malassezia* por PCR-REA. Rev Argent Microbiol 35:162–166
- Gueho E, Simmons R, Pruitt W, Meyer S, Ahearn D (1987) Association of *Malassezia pachydermatis* with systemic infections of humans. J Clin Microbiol 25:1789–1790
- Gueho E, Midgley G, Guillot J (1996) The genus *Malassezia* with description of four new species. Antonie van Leeuwenhoek 69:337–355
- Guillot J, Gueho E, Lesourd M, Midgley G, Chevrier G, Dupont B (1996) Identification of *Malassezia* species. J Mycol Med 6:103–110
- Guillot J, Deville M, Berthelemy M, Provost F, Guého E (2000) a single PCR-restriction endonuclease analysis for rapid identification of *Malassezia* species. Lett Appl Microbiol 31:400–403
- González A, Sierra R, Cárdenas ME, Grajales A, Restrepo S, Cepero de García MC, Celis A (2009) Physiological and molecular characterization of atypical isolates of *Malassezia furfur*. J Clin Microbiol 47:48–53
- Gupta AK, Kohli Y, Summerbell RC (2000) Molecular differentiation of seven *Malassezia* species. J Clin Microbiol 38:1869–1875
- Gupta AK, Boekhout T, Theelen B, Summerbell R, Batra R (2004a) Identification and typing of *Malassezia* species by amplified length polymorphism and sequence analysis of the internal transcribed spacer and large-subunit regions of ribosomal DNA. J Clin Microbiol 42:4253–4260
- Gupta AK, Batra R, Bluhm R, Boekhout T, Dawson TL Jr (2004b) Skin diseases associated with *Malassezia* species. J Am Acad 51:785–798
- Hillis DM, Mable BK, Larson A, Davis SK, Zimmer EA (1996) Nucleic acids IV: sequencing and cloning. In: Hillis DM, Moritz G, Mable BK (eds) Molecular systematics, 2nd edn. Sinauer, Canada, pp 343–356

- Hirai A, Kano R, Makimura K, Yasuda K, Konishi K, Yamaguchi H (2002) A unique isolate of *Malassezia* from a cat. *J Vet Med Sci* 64:957–959
- Hirai A, Kano R, Makimura K, Robson E, Soares J, Lachance MA et al (2004) *Malassezia nana* sp. nov., a novel lipid-dependent yeast species isolated from animals. *Int J Syst Evol Microbiol* 54:623–627
- Hossain H, Landgraff V, Weiss R et al (2007) Genetic and biochemical characterization of *Malassezia pachydermatis* with particular attention to pigment-producing subgroups. *Med Mycol* 45:41–49
- Juncosa Morros T, González-Cuevas A, Alayeto-Ortega J, Muñoz-almagro C, Moreno-Hernando J, Gené-Giralt A, Latorre-Otín C (2002) Colonización cutánea neonatal por *Malassezia* spp. *An Esp Pediatr* 57:452–456
- Kaneko T, Makimura K, Abe M et al (2007) Revised culture-based system for identification of *Malassezia* species. *J Clin Microbiol* 45:3737–3742
- Kano R, Aizawa T, Nakamura Y, Watanabe S, Hasegawa A (1999) Chitin synthase 2 gene sequence of *Malassezia* species. *Microbiol Immunol* 43:813–815
- Krisanty RI, Bramono K, Made Wisnu I (2009) Identification of *Malassezia* species from pityriasis versicolor in Indonesia and its relationship with clinical characteristics. *Mycoses* 52:257–262
- Kumar S, Tamura K, Nei M (2004) MEGA3: integrated software for molecular evolutionary genetics analysis and sequence alignment. *Brief Bioinform* 5:150–163
- Kurtzman CP, Robnett CJ (1997) Identification of clinically important *Ascomycetous* yeasts based on nucleotide divergence in the 5' end of the large –subunit (26S) ribosomal DNA gene. *J Clin Microbiol* 35:1216–1223
- León-Mateos A, Paredes Suárez C, Pereiro M, Toribio J (2006) Study of the ITS region in an atypical isolate and comparison with six species of *Microsporium*. *Mycoses* 49:452–456
- Makimura K, Tamura Y, Kudo M, Uchida K, Saito H, Yamaguchi H (2000) Species identification and strain typing of *Malassezia* species stock strains and clinical isolates based on the DNA sequences of nuclear ribosomal internal transcribed spacer 1 regions. *J Med Microbiol* 49:29–35
- Martin K, Rygiewicz PT (2005) Fungal-specific PCR primers developed for analysis of the ITS region of environmental DNA extracts. *BMC Microbiol* 5:28–38
- Midgley G (2000) The lipophilic yeasts: state of the art and prospects. *Med Mycol* 38:9–16
- Mirhendi H, Makimura K, Zomorodian K, Yamada T, Sugita T, Yamaguchi H (2005) A simple PCR-RFLP method for identification of 11 *Malassezia* species. *J Microbiol Methods* 61:281–284
- Nell A, James SA, Bond CJ et al (2002) Identification and distribution of a novel *Malassezia* species yeast on normal equine skin. *Vet Rec* 150:395–398
- Okuda C, Ito M, Naka W et al (1998) Pityriasis versicolor with a unique clinical appearance. *Med Mycol* 36:331–334
- Paulino L, Tseng C, Strober B, Blaser M (2006) Molecular analysis of fungal microbiota in samples from healthy human skin and psoriatic lesions. *J Clin Microbiol* 44:2933–2941
- Paulino L, Tseng C, Blaser M (2008) Analysis of *Malassezia* microbiota in healthy superficial human skin and in psoriatic lesions by multiplex real-time PCR. *FEMS Yeast Res* 8:460–471
- Pereiro-Miguens M (1999) Situación actual de las infecciones por *Malassezia*. *Piel* 14:76–87
- Prohic A, Ozegovic L (2006) *Malassezia* species isolated from lesional and non-lesional skin in patients with pityriasis versicolor. *Mycoses* 50:58–63
- Prohic A (2009). Distribution of *Malassezia* species in seborrheic dermatitis: correlation with patients' cellular immune status. *Mycoses* (In press). doi:10.1111/j.1439-0507.2009.01713.x
- Pryce T, Palladino S, Price D et al (2006) Rapid identification of fungal pathogens in BacT/ALERT, BACTEC and BBL MGIT media using polymerase chain reaction and DNA sequencing of the internal transcribed spacer regions. *Diagn Microbiol Infect Dis* 54:289–297
- Sandström MH, Tengvall M, Johansson C, Bartosik J, Bäck O, Särnhult T et al (2005) The prevalence of *Malassezia* yeasts in patients with atopic dermatitis, seborrheic dermatitis and healthy controls. *Acta Derm Venereol* 85:17–23

- Sugita T, Suto H, Unno T et al (2001) Molecular analysis of *Malassezia* microflora on the skin of atopic dermatitis patients and healthy subjects. *J Clin Microbiol* 39:3486–3490
- Sugita T, Takashima M, Shinoda T, Suto H, Unno T, Tsuboi R, Ogawa H, Nishikawa A (2002) New yeast species, *Malassezia dermatis*, isolated from patients with atopic dermatitis. *J Clin Microbiol* 40:1363–1367
- Sugita T, Kodama M, Saito M et al (2003a) Sequence diversity of the intergenic spacer region of the rRNA gene of *Malassezia globosa* colonizing the skin of patients with atopic dermatitis and healthy individuals. *J Clin Microbiol* 41:3022–3027
- Sugita T, Takashima M, Kodama M, Tsuboi R, Nishikawa A (2003b) Description of a new yeast species, *Malassezia japonica*, and its detection in patients with atopic dermatitis and healthy subjects. *J Clin Microbiol* 41:4695–4699
- Sugita T, Tajima M, Takashima M et al (2004) A new yeast, *Malassezia yamatoensis*, isolated from a patient with seborrheic dermatitis, and its distribution in patients and healthy subjects. *Microbiol Immunol* 48:579–583
- Theelen B, Silvestri M, Guého E, Van Belkum A, Boekhout T (2001) Identification and typing of *Malassezia* yeasts using amplified fragment length polymorphism (AFLP), random amplified polymorphic DNA (RAPD) and denaturing gradient gel electrophoresis (DGGE). *FEMS Yeast Res* 1:79–86
- Yamada Y, Makimura K, Ueda K et al (2003) DNA base alignment and taxonomic study of the genus *Malassezia* based upon partial sequences of mitochondrial large subunit ribosomal RNA gene. *Microbiol Immunol* 47:475–478

## Chapter 17

# DNA-Based Detection of Human Pathogenic Fungi: Dermatophytes, Opportunists, and Causative Agents of Deep Mycoses

Lorenza Putignani, Silvia D'Arezzo, Maria Grazia Paglia, and Paolo Visca

**Abstract** The affordability of modern molecular biology tools and the availability of whole genome sequences have brought substantial improvement in research on pathogenic fungi and diagnosis of fungal infection. Molecular methods have resolved many critical aspects of mycological diagnosis by (1) providing species-level identification of fungi through sequencing of suitable taxonomic markers; (2) shortening of the time required for microbiological confirmation of life-threatening fungal infections; and (3) tracing the molecular epidemiology of fungal diseases. Nucleic acids-based methods are less subjective than microscopy- or culture-based methods and unaffected by fungal growth conditions, thus capable of discriminating between phenotypically undistinguishable species. This chapter focuses on the contribution of DNA-based techniques to the identification of clinically important fungi such as *Aspergillus*, *Blastomyces*, *Candida*, *Coccidioides*, *Cryptococcus*, *Dematiaceous* fungi, *Fusarium*, *Histoplasma*, *Trichosporon*, *Zygomycetes*, and *Dermatophytes*. Because of their excellent performances, molecular assays are being increasingly adopted by clinical laboratories to complement conventional methods, providing new diagnostic capabilities.

---

L. Putignani

Microbiology Unit, Children's Hospital, Healthcare and Research Institute Bambino Gesù, Piazza Sant'Onofrio 4, 00165 Rome, Italy

S. D'Arezzo and M. G. Paglia

National Institute for Infectious Diseases "Lazzaro Spallanzani" I.R.C.C.S., Via Portuense 292, 00149 Rome, Italy

P. Visca

National Institute for Infectious Diseases "Lazzaro Spallanzani" I.R.C.C.S., Via Portuense 292, 00149 Rome, Italy

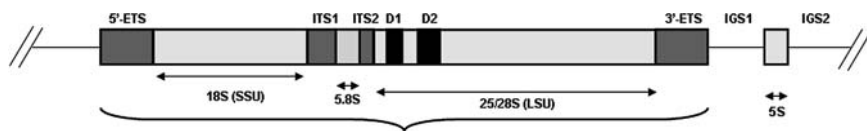
Department of Biology, University of Roma Tre, Viale Marconi 446, 00146 Rome, Italy

e-mail: visca@uniroma3.it

## 17.1 Introduction

Fungal pathogens are currently rivaling their bacterial counterparts as emerging agents of nosocomial and community-acquired infections, posing a particular risk to patients under sustained immunosuppression. Deep mycoses and systemic mycotic infections have gained importance as potentially life-threatening opportunistic infections. This is due to the increasing number of immunocompromised individuals or the underlying risk factors, such as AIDS and cancer patients, organ transplant recipients, and patients under intensive care or predisposing concomitant treatments such as steroid, immunosuppressive, antineoplastic, and antibiotic chemotherapy. Indeed, the progress in transplant medicine and the therapy of hematological malignancies are counteracted by the threat of invasive or disseminated fungal infections (IFI), mainly triggered by species belonging to genus *Candida* and *Aspergillus* (Kontoyiannis and Bodey 2002; Pfaller and Diekema 2007). However, cutaneous fungi are also becoming emerging agents of hematogenously disseminated infections in the immunosuppressed host with severe or fatal prognosis (Cornely 2008).

Recently, a substantial progress in fungal classification and identification has been achieved by means of molecular studies aimed at (1) tracing of evolutionary link between groups at higher taxonomic ranks through phylogenetic investigation; (2) improving taxonomy, mostly at the level of genera and species; (3) developing diagnostic applications for new defined taxonomic units; and (4) improving the epidemiological tools to monitor outbreaks and transmission routes of infection to subspecific entities (Yeo and Wong 2002). These broad aims have been achieved by optimizing techniques (Guarro et al. 1999) based on highly performing molecular targets, which serve as evolutionary clocks for phylogenetic studies (Yeo and Wong, 2002). One such target is the group of genes encoding the nuclear ribosomal RNA (rRNA). The main reasons for the success of the ribosomal DNA (rDNA) as an evolutionary marker is that its sequences encode for multiple-copy loci, whose repeated copies *in tandem* are synchronized by concerted evolution, and it is therefore reasonably treated as a single locus (Guarro et al. 1999). Furthermore, ribosomes are present in all organisms, with a common evolutionary origin. Parts of the molecule are highly conserved (van de Peer et al. 1996; van de Peer et al. 1997) and serve as reference points for evolutionary divergence studies. The 5.8S, 18S, and 25–28S rRNA genes (or rDNAs) are transcribed as a 35S to 40S precursors, along with internal and external transcribed spacers (ITS and ETS, respectively), which are spliced out of the transcript (Guarro et al. 1999) (Fig. 17.1). The conserved regions alternate with divergent domains (D1 and D2) and highly variable regions (ITS) (Hassouna et al. 1984) (Fig. 17.1). Between each cluster, there is a nontranscribed or intergenic spacer (NTS or IGS) that serves to separate the repeats from one another along the chromosome (Fig. 17.1). A 5S rRNA gene takes a variable position and transcription direction depending on the fungal group (Fig. 17.1). The total length of one DNA repeat is between 7.7 and 24 Kb (Hibbett 1992). For phylogeny of filamentous fungi, the 18S rDNA (also called



**Fig. 17.1** Schematic drawing of the physical organization of the fungal ribosomal rRNA gene cluster. All cluster components are included in the representation. SSU, small subunit (18S rRNA gene); LSU, large subunit (25–28S rRNA gene); D1 and D2 regions are the highly divergent regions of the LSU rRNA gene, shown as *black boxes*. ITS1, ITS2, and ETS1, ETS2 represent, respectively, intergenic and extragenic spacers, shown as *dark grey boxes*. Intergenic spacers (IGS1 and IGS2), between each cluster are nontranscribed regions which separate rRNA clusters from one another along the chromosome

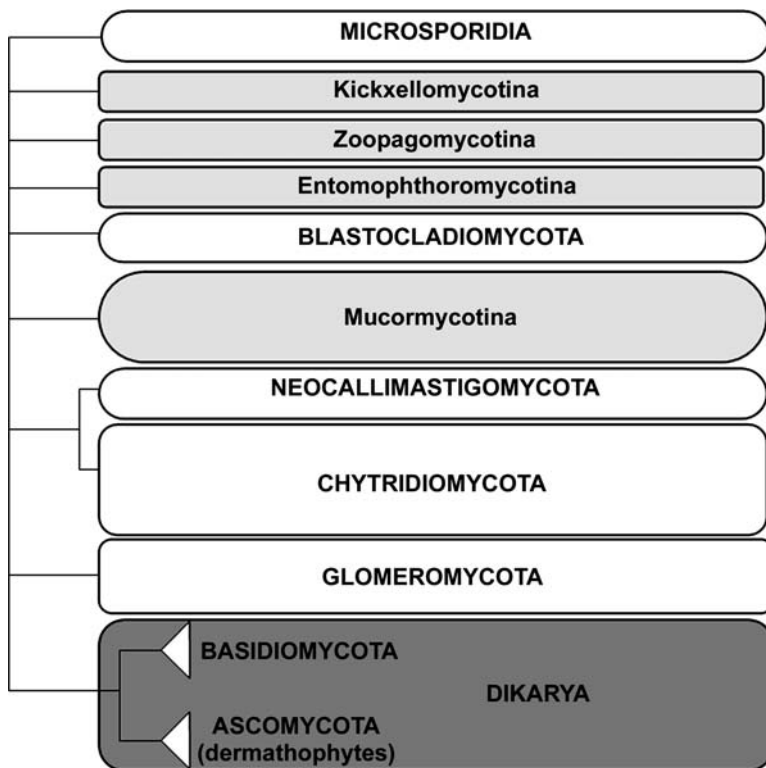
the small-subunit, SSU) is most often used either as full-length sequence or as subdomain of ca. 600 bp (Bruns et al. 1992). The divergent domains of the 25–28S (also called the large-subunit, LSU) rDNA are very informative and allow comparisons from high taxonomic levels down to the species level, although only a limited number of variable positions are present (Guého et al. 1993). In the 18S rRNA gene, the variable domains mostly provide insufficient information for diagnostic purposes (de Hoog and Gerrits van den Ende 1998), and large parts of the molecule must be sequenced to obtain the resolution required for species identification (de Hoog and Gerrits van den Ende 1992). In contrast, the 5.8S rDNA is too small and has the least variability. The 5S molecule has mainly been used to infer relationships at the order level, where differences could be traced back to the secondary structure of the molecule (Walker and Doolittle 1982). The ITS regions are much more variable, and sequences can be aligned with confidence only between closely related taxa. These regions have been extensively used to assess intraspecies differentiation (Kurtzman and Robnett 1991, 1998; Kurtzman and Fell 1998; Lott et al. 1998; Iwen 2003; Hinrikson et al. 2005). In yeasts, the D1 and D2 variable regions of the 25–28S rDNA have been extensively used for species-level identification (Sandhu et al. 1995; Sanguinetti et al. 2007; Linton et al. 2007; Putignani et al. 2008b) (Fig. 17.1). A region encompassing the D2 domain has also been exploited to produce a commercial sequencing kit based on the interrogation of libraries of fungal D2 rDNA sequences (MicroSeq D2 LSU rDNA Fungal Identification Kit, Applied Biosystems). The MicroSeq system is composed of PCR and cycle sequencing modules, identification and analysis software, and a D2 sequence library (Hall et al. 2003, 2004). Also mitochondrial targets, considered as “multicopy” loci because of the multiplicity of mitochondria per cell, have been exploited as molecular tools for the classification and identification of molds and yeasts (Guarro et al. 1999; Wang et al. 2000; Yeo and Wong 2002; Yamada et al. 2004). Introns of several protein-encoding genes, such as the  $\beta$ -tubulin (Tsai et al. 1994), actin (Cox et al. 1995), chitin synthase (Bowen et al. 1992), acetyl coenzyme A synthase (Birch et al. 1992), glyceraldehyde-3-phosphate dehydrogenase (Harmsen et al. 1992), lignin peroxidase (Naidu et al. 1990), or orotidine 5'-monophosphate decarboxylase (Radford 1993) genes, can also provide information at the species level. Recently, repetitive genome

sequences (rep) have also been exploited as taxonomical tools for identification of *Aspergillus* spp. (Healy et al. 2004; Hansen et al. 2008) and *Candida* spp. (Wise et al. 2007) or for genomic fingerprinting (rep-PCR) assays adapted to an automated platform (DiversiLab system, Biomerieux).

Amongst clinically relevant fungi, there are three main groups quite different from one another and classified according to their biological characteristics. One group is composed of dimorphic saprobes, which include soil-borne fungi that have developed the ability to switch from a yeast to a hyphal morphology to adapt to the hostile environment of the human body (Guarro et al. 1999). The dimorphic pathogens (e.g., *Histoplasma capsulatum*, *Coccidioides immitis*, *Blastomyces dermatitidis*, *Paracoccidioides brasiliensis*, *Sporothrix schenckii*, *Penicillium marneffeii*) are incorporated in the Ascomycota and belong to the Plectomycetes group, a class of the supraordinal systematics defined according to the asci arrangement (Müller and von Arx 1973). The second group, which is the most numerous, consists of opportunistic saprobes, which cause opportunistic mycoses in individuals whose immune system is deficient or artificially suppressed (Kendrick 1992). This group includes *Aspergillus*, *Fusarium*, *Rhizopus* and *Mucor* genera, dematiaceous fungi, yeasts (*Candida*, *Cryptococcus*, *Trichosporon*), and zygomycetes. The third large group refers to dermatophytes, a group of obligate parasites, which attack the human skin, nails, and hair and are therefore mainly related to superficial mycoses (Kendrick 1992). This group includes *Epidermophyton*, *Trichophyton*, and *Microsporum* genera. From a taxonomical view point, the pathogenic and opportunistic fungi are distributed among three major phyla of the Kingdom Fungi: Ascomycota, Basidiomycota, and Zygomycota (Guarro et al. 1999). Recently, a new comprehensive phylogenetic classification of the Kingdom Fungi has been proposed, with reference to recent molecular phylogenetic analyses, and supported by several members of the fungal taxonomic community (Hibbett et al. 2007). Subkingdoms Dikarya and Basal Fungi include the main phyla of medical relevance. The dermatophytes are not a particular phylum but rather a short-hand label for the group of the three fungal genera *Epidermophyton*, *Trichophyton*, and *Microsporum*, all belonging to Ascomycota phylum (Fig. 17.2). Generally, the large fungal Phylum Glomeromycota are plant symbionts, Chytridiomycota and Neocallimastigomycota are animal pathogens, while Blastocladiomycota are algal pathogens (Hibbett et al. 2007) (Fig. 17.2).

Apart from the taxonomic reevaluation, the teleomorph or anamorph relationship (sexual and asexual reproductive stages, respectively) within the phyla Ascomycota and Basidiomycota must also be taken into account for correct identification and proper description of medically important fungi, especially in laboratory reports to the clinical staff. Therefore, the species names reported hereafter will usually refer to the anamorph nomenclature or, alternatively, to the teleomorph name when commonly used in practice. However, nomenclature interconversion from teleomorph to anamorph can be promptly achieved by interrogation of dedicated internet-based taxonomy browsers (e.g., <http://www.doctorfungus.org/imageban/help.htm>; <http://www.ncbi.nlm.nih.gov/Taxonomy/Browser/wwwtax.cgi>).





**Fig. 17.2** Schematic phylogeny and classification of fungal human pathogens within the Basal Fungi and Dikarya Subkingdoms. The pathogenic and opportunistic human fungi are distributed among the three major phyla Ascomycota, Basidiomycota, and Zygomycota of the Kingdom Fungi. Subkingdom Dikarya include both Ascomycota and Basidiomycota (*dark grey*), while Zygomycota (*pale grey*) belong to the Basal Fungi despite a pending resolution of relationships among clades that still affect its definitive taxonomic location. The phylum Glomeromycota includes important plant symbionts; Chytridiomycota and Neocallimastigomycota animal pathogens, while Blastocladiomycota algal pathogens. The group of dermatophytes belong to the Ascomycota phylum. The branch lengths are not proportional to genetic distances. Modified from Hibbett et al. (2007)

From a clinical perspective, early and accurate diagnosis of fungal infections is crucial to avoid the extensive clinical use of empirical antifungal therapy, which is the primary cause for the emergence of antifungal resistance (Yeo and Wong 2002). It must be pointed out that a major drawback to the successful treatment of IFIs is the lack of sensitive and specific methods for early diagnosis. Standard approaches to the laboratory diagnosis of IFIs include (1) direct microscopic visualization for the presence of organisms in freshly obtained body fluids, (2) detection of specific antibodies, (3) histopathologic demonstration of fungi within tissue sections, and (4) classical cultivation of the causative fungus with its subsequent macroscopic and biochemical identification. These approaches are not sensitive enough and/or

specific to the diagnosis of IFI, which requires invasive procedures to obtain the necessary quantity of specimens. Moreover, the diagnosis of IFI can be biased by improper samplings, not representative of the real agent and site of the infection, as well known for invasive pulmonary aspergillosis (Kappe and Rimek 1999). Furthermore, phenotypic identification of fungi requires complicated algorithms and time-consuming procedures, not always correctly interpretable in daily diagnostic routine without dedicated mycologists. Among the culture-independent methods, detection of a specific host antibody response is attractive because such tests can be performed rapidly and do not require invasive sampling procedures. However, presence of host antibodies does not always correlate with the presence of invasive mycosis, especially in patients whose humoral response is impeded by immunosuppressive drugs and/or serious underlying disease. Detection of macromolecular antigens generally requires a relatively large fungal burden, which may limit the sensitivity of these assays. Nonetheless, several examples of successful antigen detection systems exist, and some of these are widely used in the clinical mycology laboratory. Alternatives to standard culture and serologic diagnostic methods include amplification and detection of specific fungal DNA sequences and the detection and quantitation of specific fungal metabolome and proteome products. In this scenario, the diagnosis of IFIs remains a challenge because clinical symptoms are not pathognomonic, and searching for mycotic agents is delayed unless a high index of clinical suspicion is applied and a differential diagnosis provided.

This chapter will address recent advances in the DNA-based diagnosis of relevant or emerging fungal pathogens, with special attention to the IFIs, which represent an important cause of morbidity and mortality in both the developed and developing world. Progresses in advanced molecular methods for diagnosis and epidemiological typing of pathogenic fungi are becoming fundamental for early treatment of patients, controlling fungal clearance, and counteracting resistance to antifungal therapy.

## 17.2 DNA Manipulations

Specimen handling and preparation have a significant impact on the performance of molecular diagnostic tests for fungal detection. The sample preparation method should release intracellular DNA from the fungal cell wall, concentrate DNA targets that may be present in very small amounts, and eliminate contaminants, potential inhibitors, and other extraneous materials without degrading the target DNA. The availability of an easy-to-perform DNA extraction procedure, providing pure DNA devoid of PCR inhibitors, would be ideal for any PCR-based diagnostic test. Simple cytolytic procedures for DNA extraction, e.g., thermolysis, although used in some protocols (Putignani et al. 2008a, b) cannot be applied to all fungi. For instance, filamentous fungi have strong cell walls which are often resistant to traditional DNA extraction procedures. Fungal nucleases, polysaccharides, and

pigments also contribute to difficulties in purifying DNA from filamentous fungi (Hope et al. 2005). There are a multitude of nucleic acids extraction techniques (Griffiths et al. 2006). The preferable method represents a compromise between efficiency, purification yields, and transferability to the laboratory routine. DNA may be extracted using *in-house* methods, commercial kits, and automated commercial techniques. Mechanical destruction with glass beads and freeze–thaw steps with liquid nitrogen or a heat-alkali treatment have successfully been applied (Hopfer et al. 1993; Löffler et al. 1997; Griffin et al. 2002). DNA extraction following enzymatic digestion of the fungal wall is another effective method (Williamson et al. 2000). However, many of these *in house*-methods are not suited for the clinical microbiology laboratory, where many samples are simultaneously processed. Moreover, the use of toxic chemicals such as phenol–chloroform mixtures further limits the use of *in house*-methods in the clinical routine (Griffiths et al. 2006). The use of commercial kits (e.g., QIAmp Tissue, Qiagen; GeneReleaser, BioVentures; Puregene D 6000, Gentra; Dynabeads DNA DIRECT, Dynal; and DNAzol, Molecular Research Center) shortens the extraction procedure, but the efficiency of extraction of fungal DNA can vary considerably between commercial kits (Griffiths et al. 2006; Löffler et al. 1997). Automated commercial techniques (e.g., MagNA Pure LC; Roche Diagnostics) are better suited for routine clinical laboratories (Costa et al. 2002). High-speed cell disruption (HSCD) incorporating chaotropic reagents and lysing matrices provides rapid lysis of cells and high yields of DNA from medically important yeasts (e.g., *Candida albicans*, *Cryptococcus neoformans*, *Trichosporon beigeli*) and filamentous fungi (e.g., *Aspergillus* spp. and *Fusarium solani*) (Müller et al. 1998). Concerted efforts are focused on the optimization of DNA extraction methods from yeasts, particularly from blood samples in cases of candidemia (Metwally et al. 2008a, b). Although the quality of samples can affect the recovery of nucleic acids (Bougnoux et al. 1999; Fredricks et al. 2005; Metwally et al. 2008a, b bis), yeast DNA has successfully been extracted and purified from different clinical samples, including whole blood (Buchman et al. 1990), serum and plasma (Kan 1993; Bougnoux et al. 1999; Metwally et al. 2008a, b, bis), bronchoalveolar lavage fluid (Klingspor and Jalal 2006), and cerebrospinal fluid (CSF) (Ralph and Hussain 1996), using a variety of *home-made* and commercial kits protocols.

Sample contamination should also be considered as a major problem in molecular diagnosis because of the extremely high sensitivity of all nucleic acids amplification techniques. Fungal spores, such as conidia from *Aspergillus* spp. and other molds, might be present in the air. Thus, airborne spore inoculation during the DNA extraction process could potentially lead to false-positive results, especially if panfungal primers are applied (Löffler et al. 1999). However, the risk of contamination is not higher in fungal PCR assays than in other diagnostic PCRs if general precautions are taken. In order to control naturally arising DNA from airborne sources (e.g., fungal spores) negative controls should be included during each DNA extraction procedure. Negative controls consist of sterile water or blood from healthy individuals, and should be subjected to all preparation steps in parallel with the extracted samples (Sarkar and Sommer 1990; Löffler et al. 1999).

The development of semi-automated platforms that comprise nucleic acids extraction and product detection through a series of linked instruments have produced substantial implementation of molecular testing within the routine of the clinical diagnostic laboratory, strongly reducing the risk of sample contamination. The absence of post-PCR processing after amplification step, as for the on-chip platforms and the real-time PCR-based procedures, has offered many practical advantages over the use of traditional detection methods by facilitating sample processing and minimizing DNA shedding in the laboratory environment (Löffler et al. 1999).

### 17.3 Panfungal Assays

For clinical diagnostic purposes, the broad-range detection of pathogenic fungi in clinical samples is as important as the ability to identify the specific pathogen(s). The common approach involves the application of broad-ranging panfungal primers with postamplification analysis for species determination (Table 17.1). Panfungal primers are directed toward conserved regions, usually within multicopy genes, which flank sequences containing species specific polymorphisms that can be defined in postamplification analysis (Chen et al. 2002). Depending on the assay, a diverse range of fungal genera and species can be identified, including species of *Aspergillus*, *Candida*, *Cryptococcus*, *Fusarium*, *Trichosporon*, *Rhizopus* spp., etc. (Makimura et al. 1994; van Burik et al. 1998; Hendolin et al. 2000; Klingspor and Jalal, 2006; Lau et al. 2007; Schabereiter-Gurtner et al. 2007; Spiess et al. 2007; Zeng et al. 2007) (summarized in Table 17.1). The multicopy ribosomal gene complex is a useful target for these assays for reasons of sensitivity (multicopy target), high sequence conservation of 5.8S, 18S, and 25–28S rDNA regions (for panfungal primers), and high variability of its intervening ITS regions (for species specific probes) with high interspecies and low intraspecies heterogeneity (Lott et al. 1998; Iwen 2003; Hinrikson et al. 2005). Panfungal assays are potentially able to detect all fungal pathogens, but require additional tests for species-level identification. The most common approaches for species differentiation rely upon differences in restriction enzyme digestion patterns of amplicons, or their hybridization with species-specific probes (Hopfer et al. 1993; Sandhu et al. 1995; Einsele et al. 1997; Elie et al. 1998; Martin et al. 2000). Other methods, such as differences in PCR product sizes following electrophoresis, amplicon sequencing, or single-stranded conformational polymorphism analysis, have been applied (Walsh et al. 1995; Henry et al. 2000; Chen et al. 2002; Iwen 2003; Gupta et al. 2004; Iwen et al. 2004). Detection of amplicons can also be achieved by means of hybridization with enzyme-labeled oligonucleotide probe, eventually in microtiter plate-based enzyme immunoassay (Elie et al. 1998; Löffler et al. 1998; Wahyuningsih et al. 2000), or fluorogenic probes (Guiver et al. 2001; Maaroufi et al. 2003; Selvarangan et al. 2003), or by Southern blotting (Sandhu et al. 1995; Einsele et al. 1997; van Burik et al. 1998; Evertsson et al. 2000). The use of a

Table 17.1 Main DNA-based wide-broad range and panfungal assays

Target DNA	Specimen	Method	Detection method	Specificity	References
18S rRNA	Blood	PCR	Southern blot	<i>Aspergillus</i> spp., <i>Candida</i> spp.	Einsele et al. (1997)
18S rRNA	Culture	PCR-SSCP <sup>a</sup>	Ethidium bromide staining	<i>Aspergillus</i> spp., <i>Candida</i> spp., <i>Cryptococcus neoformans</i> , <i>Pseudallescheria boydii</i> , <i>Rhizopus arrhizus</i>	Walsh et al. (1995)
18S rRNA	Blood	PCR	Southern blot	<i>Aspergillus</i> spp., <i>Candida</i> spp.	Van Burik et al. (1998)
18S rRNA	Culture	PCR-RFLP	Ethidium bromide staining	<i>Absidia</i> spp., <i>Mucor</i> spp., <i>Rhizopus</i> spp., <i>Rhizomucor</i> spp.	Machouart et al. (2006)
28S rRNA	Cervical swab, nail and horny skin scraping, serum, blood, urine	Real Time	TaqMan and sequencing	<i>Aspergillus</i> spp., <i>Candida</i> spp., <i>Cryptococcus</i> spp., <i>Mucor</i> spp., <i>Penicillium</i> spp., <i>Pichia</i> spp., <i>Microsporium</i> spp., <i>Trichophyton</i> spp., <i>Scopulariopsis</i> spp.	Vollmer et al. (2008)
28S rRNA	Blood	PCR	Southern blot	<i>Aspergillus</i> spp., <i>Candida</i> spp., <i>C. neoformans</i>	Evertsson et al. (2000)
28S rRNA	Respiratory (BAL) and tissues	Real Time	FRET	<i>Rhizopus</i> spp., <i>Mucor</i> spp., <i>Rhizomucor</i> spp.	Kasai et al. (2008)
28S rRNA	Blood, respiratory, tissue	Real Time	TaqMan	<i>Aspergillus</i> spp., <i>Candida</i> spp.	Basková et al. (2007)
ITS	Skin, nail, wound, urine, blood, respiratory, tissue	PCR	ELISA	<i>Aspergillus</i> spp., <i>Candida</i> spp.	Badiee et al. (2007)
ITS1	Fresh and formalin-fixed, paraffin-embedded tissue	PCR	Sequencing	<i>Candida</i> spp., <i>Cryptococcus</i> spp., <i>Trichosporon</i> spp., <i>Aspergillus</i> spp., <i>Fusarium</i> spp., <i>Scedosporium</i> spp., <i>Exophiala</i> spp., <i>Exserohilum</i> spp., <i>Apophysomyces</i> spp., <i>Actinomyces</i> spp., <i>Rhizopus</i> spp.	Lau et al. (2007)
ITS1-5.8S rRNA-ITS2	Tissues	PCR	Multiplex liquid hybridization and sequencing	<i>Aspergillus</i> spp., <i>Candida</i> spp., <i>C. neoformans</i>	Hendolin et al. (2000)

(continued)

Table 17.1 (continued)

Target DNA	Specimen	Method	Detection method	Specificity	References
ITS1-5.8S rRNA-ITS2	Culture	INNO-LiPA	Enzyme immunoassay	<i>Aspergillus</i> spp., <i>Candida</i> spp., <i>Cryptococcus</i> spp.	Martin et al. (2000)
18S rRNA, 5.8S, ITS1	Blood, tissues and respiratory (BAL)	Multiplex-PCR	Microarray hybridization	<i>Aspergillus</i> spp., <i>Candida</i> spp., <i>Fusarium</i> spp., <i>Mucor racemosus</i> , <i>Rhizopus microsporus</i> , <i>Scedosporium prolificans</i> , <i>Trichosporon asahii</i>	Spieß et al. (2007)
ITS2	Culture	PCR	Fluorescent capillary electrophoresis	<i>Aspergillus</i> spp., <i>Candida</i> spp., <i>Epidermophyton floccosum</i> , <i>Microsporium</i> spp., <i>Trichophyton</i> spp.	Turenne et al. (1999)
ITS2	Culture	Reverse line blot hybridization	Enzyme immunoassay	<i>Aspergillus</i> spp., <i>Candida</i> spp., <i>Cryptococcus</i> spp.	Playford et al. (2006)
Repetitive sequences	Culture	Rep-PCR	Microfluidics chip	<i>Coccidioides</i> spp., <i>Blastomyces dermatitidis</i> , <i>Histoplasma capsulatum</i>	Pounder et al. (2006)
Cytochrome b	Culture and tissues	Real Time	FRET	<i>Absidia</i> spp., <i>Apophysomyces</i> spp., <i>Cunninghamella</i> spp., <i>Mucor</i> spp., <i>Rhizopus</i> spp., <i>Saksenaea</i> spp.	Hata et al. (2008)
18S rRNA	Blood, respiratory, bile, drainage, urine, pleura, CSF, biopsy	Real Time	TaqMan	<i>Aspergillus</i> spp., <i>Candida</i> spp.	Klingspor and Jalal (2006)
ITS2	Blood, respiratory, tissues	Real time	Melting point	<i>Aspergillus</i> spp., <i>Candida</i> spp.	Schabereiter-Gurtner et al. (2007)
ITS1/ITS2	Blood, respiratory (BAL), tissue, CSF, skin	PCR-reverse line blot (RLB)	Chemiluminescence	<i>Aspergillus</i> spp., <i>Candida</i> spp., <i>Cryptococcus</i> spp.	Zeng et al. (2007)

<sup>a</sup>Single-strand conformational polymorphism

panfungal PCR followed by hybridization with species-specific probes is a practical solution to the problem of fungal detection.

## 17.4 *Aspergillus* spp.

*Aspergillus* spp. are filamentous, cosmopolitan, ubiquitous fungi which can cause life-threatening infections, especially in immunocompromised patients. *Aspergillus* spp. are commonly isolated from the soil, plant debris, and the indoor environment, including hospitals (Latgé 1999). The genus *Aspergillus* includes over 185 species. Nearly 20 species have been reported as causative agents of opportunistic infections in humans. *A. fumigatus* is the most frequently isolated species in the clinical setting. Other common species associated with infection are *A. flavus*, *A. niger*, and *A. terreus*, while *A. nidulans*, *A. versicolor*, *A. candidus*, *A. oryzae*, *A. sydowii*, and *A. clavatus* have been rarely documented (Patterson 2005). Aspergillosis includes a large spectrum of fungal diseases which primarily affect the lung. The transmission of fungal spores to the human host is via inhalation (Zmeili and Soubani 2007). *Aspergillus* spp. may cause a variety of pulmonary diseases, depending on immune status and the presence of underlying lung disease. These manifestations range from hypersensitivity reactions (allergic bronchopulmonary aspergillosis, ABPA) to noninvasive colonization of previously damaged tissue (pulmonary aspergilloma) to acute or chronic limited invasive disease (chronic necrotizing pulmonary aspergillosis) to rapidly progressive invasive disease (invasive aspergillosis) (Patterson 2005; Zmeili and Soubani 2007). Invasive aspergillosis is an often fatal infection that occurs in severely immunosuppressed patients, and is characterized by invasion of blood vessels and organ dissemination, resulting in significant morbidity and mortality (Kontoyiannis et al. 2002).

Risk factors for invasive aspergillosis are severe neutropenia, hematopoietic stem cell and solid organ transplantation, prolonged and high-dose corticosteroid therapy, hematological malignancy, cytotoxic therapy, AIDS, and chronic granulomatous disease (Segal and Walsh 2006; Zmeili and Soubani 2007). The incidence of life threatening invasive *Aspergillus* infections has been increasing with the growing number of transplant patients and patients with leukemia, lymphoma, and other malignancies. Incidence rates of invasive *Aspergillus* infection are about 17–26% in lung transplant patients, 5–24% in acute leukemia patients, 5–15% in allogenic bone marrow transplant patients, 2–13% in heart transplant patients, and 1–3% in lymphoma patients (Patterson et al. 2000; Kontoyiannis et al. 2002).

### 17.4.1 *Laboratory Diagnosis*

Given that invasive *Aspergillus* infections are associated with high crude and attributable mortality rates, early, rapid, and accurate diagnosis is important in

order to guide the selection of appropriate antifungal therapy and thus improve patient outcomes, as well as for epidemiological purposes. Earlier detection of infection permits prompt initiation of antifungal therapy with greater likelihood for improved survival and reduced morbidity. Moreover, diagnostic tests with a high negative predictive value may allow expensive and potentially toxic antifungal drugs to be withheld (Hope et al. 2005). The traditional diagnostics include microscopy, culture on agar media, antigenemia, and search for antibodies. All of them are limited either by poor sensitivity, narrow temporal window for fungal detection, complex interpretation and high levels of nonspecific reactions. Positive culture of *Aspergillus* spp., although indicative, is not a substantial proof of infection. Furthermore, culture-based phenotypic identification techniques are slow and prone to misidentification (Reiss and Morrison 1993). The “gold standard” investigation remains microbiological and/or histological evidence of tissue invasion, which is not always achievable (Bretagne and Costa 2005).

The detection of galactomannan has been included into the routine practise for diagnosis of invasive aspergillosis (Hope et al. 2005). There are two commercial assays for the detection of galactomannan: the latex agglutination test (e.g., Pastorex Aspergillus; Sanofi Diagnostics Pasteur) and a double-antibody sandwich enzyme immunoassay (e.g., Bio-Rad Platelia® Aspergillus EIA, Bio-Rad Laboratories). However, the growth phase, microenvironment, host immune status, and pathology may all influence galactomannan release and hence the results of immunological tests (Latgé et al. 1994). Furthermore, cross reactivity with other filamentous fungi, bacteria, drugs, and cotton swabs have been documented (Kappe and Schulze-Berge 1993; Hashiguchi et al. 1994; Swanink et al. 1997; Dalle et al. 2002; Mennink-Kersten et al. 2004).

### **17.4.2 Molecular Detection**

The application of PCR technology to molecular diagnostics holds great promise for the early identification of *Aspergillus* spp. (Williamson and Leeming 1999; Klingspor and Loeffler 2009). DNA-based assays rapidly detect the presence of fungal DNA in blood and other sterile body fluids with high sensitivity and specificity (Williamson and Leeming 1999), particularly since parts of the fungal genome, especially multicopy gene targets, were identified and sequenced (Buchheidt and Hummel 2005). For early detection of *Aspergillus* spp. in clinical samples, several groups have succeeded in defining target gene sequences, practicable primers, and effective DNA extraction methods. Technical difficulties, such as differentiation and specification of the amplicons, have also been overcome by different approaches (e.g., species-specific oligonucleotide probes and PCR ELISA). A variety of PCR protocols for human samples have been published, including panfungal PCR assays (Table 17.1) and methods that detect one species or genus (Table 17.2). Using different primer sets, PCR has been recommended by several studies as a useful tool in establishing the diagnosis of invasive aspergillosis



Table 17.2 Main DNA-based assays for *Aspergillus* spp. identification

Target DNA	Specimen	Method	Detection method	Specificity	References
18S rRNA	Respiratory	PCR	Southern blot	<i>Aspergillus</i> spp.	Makimura et al. (1994)
18S rRNA	Blood	Real Time	FRET	<i>A. fumigatus</i>	Löffler et al. (2000)
18S rRNA	Blood and plasma	Real Time	TaqMan	<i>Aspergillus</i> spp.	Kami et al. (2001)
18S rRNA	Respiratory (BAL)	Real Time	TaqMan	<i>A. fumigatus</i> , <i>A. flavus</i> , <i>A. glaucus</i> , <i>A. niger</i> , <i>A. terreus</i>	Sanguinetti et al. (2003)
18S rRNA	Blood, CSF, ascitic fluid, tissue	Real Time	TaqMan	<i>A. fumigatus</i> , <i>A. flavus</i> , <i>A. nidulans</i> , <i>A. niger</i> , <i>A. ochraceus</i> , <i>A. terreus</i> , <i>A. ustus</i> , <i>A. versicolor</i>	Halliday et al. (2005)
18S rRNA	Respiratory (BAL)	PCR-RFLP	Southern blot	<i>A. fumigatus</i> , <i>A. flavus</i> , <i>A. terreus</i> , <i>A. nidulans</i> , <i>A. niger</i>	Melchers et al. (1994)
5.8S rRNA	Serum	Real Time	TaqMan	<i>Aspergillus</i> spp.	Pham et al. (2003)
28S rRNA	Serum	Real Time	TaqMan	<i>A. fumigatus</i>	Challier et al. (2004)
26S-ITS	Respiratory (BAL)	PCR	Southern blot	<i>A. fumigatus</i>	Spreadbury et al. (1993)
ITS1-5.8S rRNA-ITS2	Culture	PCR	Sequencing	<i>A. fumigatus</i> , <i>A. flavus</i> , <i>A. terreus</i> , <i>A. niger</i> , <i>A. ustus</i> , <i>A. nidulans</i>	Henry et al. (2000)
ITS1-5.8S rRNA-ITS2	Culture	PCR-SSCP	Silver staining	<i>A. fumigatus</i> , <i>A. flavus</i> , <i>A. terreus</i> , <i>A. niger</i> , <i>A. nidulans</i>	Rath and Ansorg (2000)
ITS1-5.8S rRNA-ITS2	Culture	PCR	Ethidium bromide staining	<i>A. fumigatus</i>	Zhao et al. (2001)
ITS2	Culture and tissue	PCR	ELISA	<i>A. fumigatus</i> , <i>A. flavus</i> , <i>A. terreus</i> , <i>A. niger</i> , <i>A. nidulans</i> , <i>A. ustus</i> , <i>A. versicolor</i>	De Aguirre et al. (2004)
18S rRNA	Blood	Real Time	TaqMan	<i>A. fumigatus</i> , <i>A. flavus</i> , <i>A. terreus</i> , <i>A. niger</i>	Faber et al. (2009)
ITS1-5.8S rRNA-ITS2 and aspergillopepsin 1 <sup>st</sup> and 4 <sup>th</sup> exon	Culture	PCR	Ethidium bromide staining	<i>A. fumigatus</i> , <i>A. flavus</i> , <i>A. terreus</i> , <i>A. niger</i>	Logotheti et al. (2009)
ITS	Blood culture	Real-Time Septifast	Melting curve	<i>A. fumigatus</i>	Mancini et al. (2008)

(continued)

Table 17.2 (continued)

Target DNA	Specimen	Method	Detection method	Specificity	References
Mitochondrial tRNA	Respiratory (BAL)	PCR	Southern blot	<i>A. fumigatus</i> , <i>A. flavus</i> , <i>A. terreus</i> , <i>A. niger</i>	Bretagne et al. (1995)
Mitochondrial tRNA	Respiratory (BAL)	PCR	Southern blot	<i>A. fumigatus</i> , <i>A. flavus</i> , <i>A. terreus</i> , <i>A. niger</i>	Raad et al. (2002)
Mitochondrial tRNA	Tissues	PCR	Sequencing	<i>Aspergillus</i> spp.	Rickerts et al. (2006)
Mitochondrial tRNA	Blood and serum	Real Time	TaqMan	<i>A. fumigatus</i>	Costa et al. (2001)
Mitochondrial tRNA	Serum	Real Time	FRET	<i>A. fumigatus</i> , <i>A. flavus</i>	Costa et al. (2002)
Mitochondrial tRNA	Respiratory (BAL) and tissues	Real Time	FRET	<i>A. fumigatus</i>	Rantakokko-Jalava et al. (2003)
Mitochondrial cytochrome b	Respiratory (BAL) and blood	Real Time	FRET	<i>A. fumigatus</i>	Spiess et al. (2003)
IgE-binding protein	Blood and urine	PCR	Southern blot	<i>A. fumigatus</i>	Reddy et al. (1993)
FKS	Blood and serum	Real Time	TaqMan	<i>A. fumigatus</i>	Costa et al. (2001)
Repetitive sequences	Culture	Rep-PCR	Microfluidics chip	<i>A. fumigatus</i> , <i>A. flavus</i> , <i>A. terreus</i>	Healy et al. (2004)
Repetitive sequences	Culture	Rep-PCR	Microfluidics chip	<i>A. fumigatus</i> , <i>A. flavus</i> , <i>A. terreus</i> , <i>A. niger</i> , <i>A. ochraceus</i> , <i>A. candidus</i> , <i>A. sydowii</i> , <i>A. versicolor</i> , <i>A. nidulans</i>	Hansen et al. (2008)

(Spreadbury et al. 1993; Tang et al. 1993; Melchers et al. 1994; Skladny et al. 1999). However, the lack of standardization of technical issues continues to represent a considerable barrier for the widespread application of PCR in the diagnosis of invasive aspergillosis (Bretagne 2003; Hope et al. 2005; Mengoli et al. 2009).

PCR assays may be applied to broncho alveolar lavage (BAL) specimens, blood fractions (serum, plasma, whole blood) and tissues, including paraffin-embedded thin sections (Hope et al. 2005). Initial studies focused on detection of DNA in BAL samples (Spreadbury et al. 1993; Makimura et al. 1994; Melchers et al. 1994; Bretagne et al. 1995; Raad et al. 2002) (Table 17.2). With few exceptions, the rate of positivity was attained in 35% of the samples (Bretagne 2003). However, the inhaled *Aspergillus* spores or conidia, which are ubiquitous in the air, could lead to false-positive reactions. In fact, *Aspergillus* hyphae are often present in the air and could transiently colonize the respiratory tract of noninfected individuals or even contaminate the amplification mixture. The PCR performed on BAL cannot differentiate between infecting and colonizing fungi in the oropharyngeal and bronchoalveolar space of patients (Bretagne and Costa 2005). On the other hand, some authors have highlighted the potential value of a negative result to exclude a diagnosis of aspergillosis (Raad et al. 2002). Therefore, a negative PCR test result in a patient with a suspected infection suggests that the patient does not have invasive pulmonary aspergillosis, and most likely does not have organism colonization. Given the high rate of positivity and the difficulties in interpreting PCR positive results in bronchial specimens, several studies have switched to blood samples, reporting a high positive predictive value (>95%) (Reddy et al. 1993). The use of PCR technology with serum or plasma has several advantages over the use of BAL samples. First, assuming appropriate handling of the specimen, false-positive results do not occur from specimen contamination. Second, taking blood sample is considerably easier than obtaining BAL (Einsele et al. 1997). Compared to ELISA, however, PCR positivity seems to occur later than galactomannan detection (Bretagne et al. 1998). Therefore, the combined use of PCR and ELISA should result in a definitive diagnosis aspergillosis, even in the absence of obvious clinical signs (Bretagne et al. 1998). The optimal blood fraction for the detection of *Aspergillus* DNA remains unknown. One study, using quantitative PCR (qPCR), suggested that the yield of DNA from serum, plasma, and white cells was similar (Costa et al. 2002), while another demonstrated that the PCR signal from whole blood was superior to that from plasma (Löffler et al. 2000). Serum has the advantage of enabling concomitant antigen testing (Costa et al. 2002), and does not require the addition of anticoagulants (e.g., sodium citrate, edetic acid, or heparin) that may inhibit PCR. An important study has recently focused on the diagnostic applicability of serial blood and serum samples to diagnose IA in neutropenic patients by means of real-time quantitative PCR combined with galactomannan quantification (Cuenca-Estrella et al. 2009). Furthermore, a previous report (Suarez et al. 2008) had shown that real-time PCR assays, performed by using DNA extracted from large serum volumes, may actually represent a robust and early diagnostic tool for IA in patients under hematologic surveillance.

A variety of *in-house* and commercial PCR-based assays have been developed for the identification of *Aspergillus* species (Table 17.2). The mitochondrial tRNA genes and the (apo)cytochrome b have been used as PCR targets (Wang et al. 2000) (Table 17.2). The rep-PCR assay (DiversiLab *Aspergillus* system) enables rapid and accurate *Aspergillus* spp. identification (Healy et al. 2004; Hansen et al. 2008). This approach takes advantage of the fact that there are repetitive elements interspersed throughout the fungal genome that, when amplified by PCR, give highly discriminatory reproducible profiles within *Aspergillus* spp. The method has been developed as a user-friendly kit, and the automated detection and analysis provides readily interpretable reports (Hansen et al. 2008). Moreover, rep-PCR based identification is in full agreement with the ITS region sequence-based identification (Healy et al. 2004). The MicroSeq D2 LSU rDNA Fungal Identification Kit (Applied Biosystems) has allowed the identification of filamentous fungi, including *Aspergillus* spp., by exploiting the D2 LSU diversity region (Hall et al. 2004). Some of the newer assays are successfully using the real-time PCR technology, either the Light Cycler or TaqMan technology, both combining amplification with simultaneous amplicon detection (Table 17.2). The method applies to DNA extracted from both blood and BALs. One of the main advantages of the real-time PCR is the possibility of avoiding false positive results due to contamination with previously amplified products. Contamination is reduced because the reaction tubes need not be opened following amplification. Moreover, real-time PCR techniques can also include the systematic use of uracyl-*N*-glycosylase. The sensitive and specific quantification of the fungal burden seems to be of clinical relevance, since the assessment of the individual fungal burden may possibly allow therapeutic monitoring (Costa et al. 2001). To achieve an improved, specific, sensitive, and rapid method for quantification of the *A. fumigatus* fungal load in clinical samples, Spiess et al. (2003) established a LightCycler PCR assay to test blood and BAL samples. An optimal pair of primers and hybridization probes derived from the sequence of the *A. fumigatus* mitochondrial cytochrome b gene was selected (Spiess et al. 2003). Two new TaqMan-based PCR assays for a fungal species, one targeting a single copy gene and the other a mitochondrial gene have been developed (Costa et al. 2001). To diagnose invasive mold infection from serum samples a quantitative real-time PCR assay targeting the 5.8S rRNA gene was designed (Pham et al. 2003). This assay distinguishes invasive infections caused by *Aspergillus* spp. from those caused by *Fusarium* spp., and *Scedosporium* spp. (Pham et al. 2003). Recently, Vollmer et al. (2008) developed a broad-range 28S rDNA real-time PCR assay for the rapid detection of fungal pathogens in various clinical specimens (e.g., serum, urine, and EDTA-supplemented blood). The assay allows the simultaneous detection of and discrimination between genera of pathogenic fungi, including *Aspergillus*, *Candida*, *Cryptococcus*, *Mucor*, *Penicillium*, *Pichia*, *Microsporium*, *Trichophyton*, and *Scopulariopsis* (Vollmer et al. 2008). A rapid real-time PCR assay has recently been designed which exploits regions of the 18S rRNA locus to simultaneously detect the common *A. fumigatus*, *A. flavus*, *A. terreus*, and *A. niger* species by a differential melting point analysis (Faber et al. 2009). Concomitantly, the multiplex PCR assay described by Logotheti et al. (2009), has provided a similar panel for simultaneous

identification (*A. fumigatus*, *A. flavus*, *A. terreus*, and *A. niger*) with an easier multiplex-PCR system based on a combined ITS1-5.8S rRNA-ITS2 and aspergillopepsin first and fourth exon primer set.

Recently, the real-time PCR assay based on ITS variability has been adapted to semiautomated platforms (Light Cycler SeptiFast, Roche) significantly reducing diagnostic turnaround time, particularly for the diagnosis of *A. fumigatus*, a typical slow-growing filamentous fungus (Mancini et al. 2008).

## 17.5 *Blastomyces dermatitidis*

*B. dermatitidis* is a thermally dimorphic fungus and a probable saprobe of the soil. It is rarely isolated as a natural habitat, specifically inhabiting decaying wood material. Isolation from the environment is most likely when the sample contains soil and is rich in organic material. It is endemic in North America with highest incidence of infection in Mississippi, Ohio, and the Missouri valleys (Pappas 2004). African type *B. dermatitidis* strains isolated from cases in Africa also exist. It was demonstrated that African type strains are not identical to the North American strains. These two groups most probably constitute distinct types of *B. dermatitidis* showing geographic and serologic diversity (McCullough et al. 2000). The sexual state (teleomorph) of *B. dermatitidis* belongs to the family Onygenaceae and is referred to as *Ajellomyces dermatitidis*. *B. dermatitidis* is the only species included in the genus *Blastomyces* and is the causative agent of blastomycosis (Pappas 2004). Cutaneous and disseminated blastomycosis are the two clinical forms of the disease. Blastomycosis is generally acquired by inhalation, and initially presents with a pulmonary infection which may later disseminate to other organs. Primary cutaneous infection due to direct inoculation of the fungus into the skin is also likely. Hematogenous spread of the organism results in infection of skin, bones, kidneys, and male urogenital system. Reactivation blastomycosis and subclinical, self-limiting infections have been defined (Farr et al. 1992; Mounts and Deepe 1998). Although *B. dermatitidis* is a pathogenic fungus and blastomycosis occurs mainly in immunocompetent hosts, it may also infect immunocompromised patients, indicating that *B. dermatitidis* has now emerged as an opportunistic pathogen (Pappas 2004).

### 17.5.1 *Laboratory Diagnosis*

The morphology of the fungus is mold-like at 25°C and yeast-like at 37°C. At 25°C, septate hyaline hyphae and unbranched short conidiophores are observed. In rich medium or in infected tissue sections the fungus appears as budding yeast cells. Conversion of the mold phase to the yeast phase for definitive identification is rarely performed now (Kauffman 2006). Diagnosis is often achieved by detection

of specific antibodies, which are usually absent at presentation of symptoms, and which can be impaired in immunocompromised patients (Yeo and Wong 2002).

### 17.5.2 Molecular Detection

Since therapy and prognosis depend on early and specific diagnosis, there has been considerable interest in molecular detection of *B. dermatitidis*. Specific DNA probes have successfully been used for identification of *B. dermatitidis* isolates through different hybridization assays (Stockman et al. 1993; Sandhu et al. 1995; Lindsley et al. 2001). A sensitivity of 95% and a specificity of 100% with *B. dermatitidis* yeast cells were obtained by using two oligonucleotide pairs complementary to the 18S and 28S rDNA (Hayden et al. 2001). A nested PCR assay was established targeting the gene encoding the species-specific *B. dermatitidis* adhesin (BAD), formerly called WI-1 (Bialek et al. 2003). This assay was specific and the detection limit of 0.1 fg target DNA was comparable to the 18S rDNA PCR (Bialek et al. 2005a, b). The 18S rDNA PCR is routinely used as a screening assay, and when positive, the specific nested PCR is added to confirm the diagnosis (Table 17.3). More recently, the automated rep-PCR (DiversiLab system) has been used to identify *B. dermatitidis*, *Coccidioides*, and *H. capsulatum* isolates, providing excellent performance for the identification of *B. dermatitidis* isolates, all of which had very similar fingerprint patterns (Pounder et al. 2006).

### 17.6 *Candida* spp.

*Candida* is a complex genus comprising 163 anamorphic species with teleomorphs in at least 13 genera (Kurtzman and Fell 1998). Some of these genera, such as *Pichia* (Peterson and Kurtzman 1991) or *Debaryomyces* (Kurtzman and Robnett 1991, 1994) seem to be polyphyletic. Until few years ago, only a few pathogenic species of *Candida* were known, namely *C. albicans*, *C. parapsilosis*, *Candida krusei*, *C. tropicalis*, *Candida lusitanae*, *Candida dubliniensis*, and *Candida glabrata*. However, in recent years the number of species related to human infections has increased considerably (Hazen 1995; D'Antonio et al. 1998; Sullivan and Coleman 1998; Trofa et al. 2008). Now nearly 20 species have been identified for being associated with human infection (Hazen 1996). *Candida* spp. can either colonize or infect nearly every body surface. The various forms of candidiasis are the most frequent causes of fungal infection in man, and can present with extremely diverse clinical manifestations. *Candida* spp. can produce infections in otherwise healthy individuals, as well as in individuals with impaired immune function. Candidiasis may be superficial (cutaneous), local (mucocutaneous, affecting mouth and vagina), deep-seated (involving central nervous system, respiratory and urinary tract, cardiac, ocular, peritoneum, and vasculature affections) and disseminated as

systemic syndrome (candidemia), arisen from hematogenous spread from the primarily infected site. Systemic candidiasis is a complicate disease affecting individuals with reduced immune function or any other type of weakening of their defences. Almost any organ of the body may be involved, after beginning as an episode of candidemia, during which *Candida* can be isolated from blood. From a clinical standpoint, systemic candidiasis may differ into four forms: (1) the catheter-related candidemia, due to infection of a vascular catheter; (2) the acute disseminated candidiasis in which candidemia is present and may apparently spread to one or more organs; (3) the chronic disseminated candidiasis or hepatosplenic candidiasis, occurring after prolonged episodes of bone marrow dysfunction and neutropenia that occur during treatment for leukemia; (4) the deep organ candidiasis, in which any organ may be affected, either alone or in combination. When *Candida* disseminates, multiple organs are usually involved, with the kidney, brain, myocardium, and eye being the most common. As an aid to earlier diagnosis, considerable attention has been focused on the detection of *Candida* antigens. Despite the appearance of a large number of reports on the serologic diagnosis of disseminated candidiasis, controversies remain regarding the value of various serodiagnostic procedures. Problems with the older diagnostic tests have been reviewed in detail (Edwards 1991). Among severely immunosuppressed patients, almost all patients with candidemia have disseminated disease. The problem is compounded by the absence of positive blood cultures in many patients with disseminated disease. In these cases, a positive blood culture for *Candida* cannot be underestimated but verified by repeated sampling. However, interpretation of the ensuing result of the candidemia should be made with the recognition that 50% of the patients with disseminated candidiasis would not have positive blood cultures especially when concomitant bacteremia exists (Hockey et al. 1982; Geha and Roberts 1994). Promptness in correct fungal identification is therefore crucial in laboratory diagnosis to overcome limits arising from both serological and culture tests.

*Candida* infections are the most frequent cause of IFIs worldwide (Pfaller and Diekema 2007). In the United States, *Candida* spp. are the fourth most common cause of nosocomial bloodstream infection (Pfaller and Diekema 2007). *C. albicans* remains by far the most common species causing invasive candidiasis worldwide although the frequency of other species, including *Candida tropicalis*, *Candida parapsilosis*, *Candida glabrata*, and *Candida krusei*, has been steadily increasing over the last 10 years (Pfaller and Diekema 2007). The burden of invasive candidiasis remains substantial; after a decline in mortality throughout the early to mid 1990s, mortality rates have leveled off in recent years (Pfaller and Diekema 2007). There are a large number of well-characterized risk factors for invasive candidiasis, including (1) exposure to broad-spectrum antibiotics (Pfaller and Diekema 2007), (2) duration and degree of chemotherapy (Karabinis et al. 1988), (3) mucosal colonization (Pfaller and Diekema 2007), (4) indwelling vascular catheter (Diekema and Pfaller 2004), (5) total parenteral nutrition and severity of illness (Ostrosky-Zeichner 2003), (6) neutropenia (Prentice et al. 2000), (7) prior surgery (especially gastrointestinal) (Blumberg et al. 2001), (8) renal failure or

**Table 17.3** Main DNA-based assays for identification of medically important fungi other than *Candida*, *Aspergillus* and *Cryptococcus* spp.

Target DNA	Specimen	Method	Detection method	Specificity	References
18S rRNA	Tissues and blood	PCR	Sequencing	<i>H. capsulatum</i>	Bialek et al. (2001)
18S rRNA	Tissue	PCR	Sequencing	<i>B. dermatitidis</i>	Bialek et al. (2003)
18S rRNA	Tissues	PCR	Sequencing	<i>Rhizomucor</i> spp.	Bialek et al. (2005a, b)
18S rRNA	Culture	PCR	Ethidium bromide staining	<i>Trichosporon</i> spp.	Sugita et al. (1998)
28S rRNA	Plasma, respiratory (BAL) and tissues	Real Time	FRET	<i>Cunninghamella</i> spp.	Kasai et al. (2008)
ITS	Culture	PCR	Fluorescence	<i>Fusarium</i> spp.	Mishra et al. (2003)
ITS	Tissues and serum	PCR	Ethidium bromide staining	<i>Rhizopus</i> spp.	Nagao et al. (2005)
ITS	Culture	PCR	Sequencing	<i>Fonsecaea pedrosoi</i>	Miyagi et al. (2008)
ITS	Culture	Real Time	FRET	<i>H. capsulatum</i>	Martagon-Villamil et al. (2003)
ITS	Culture	PCR	Sequencing	<i>Trichosporon</i> spp.	Sugita et al. (1999)
ITS	Serum	PCR	Ethidium bromide staining	<i>Trichosporon asahii</i>	Sugita et al. (2001)
ITS2	Respiratory and tissue	Real Time	FRET	<i>Coccidioides</i> spp.	Binnicker et al. (2007)
IGS1	Serum	Real Time	TaqMan	<i>Trichosporon asahii</i>	Mekha et al. (2007)
IGS1	Culture	PCR	Sequencing	<i>Trichosporon</i> spp.	Rodriguez-Tudela et al. (2005)
M antigen	Culture	PCR	Ethidium bromide staining	<i>H. capsulatum</i>	Guedes et al. (2003)
H antigen	Blood and tissues	PCR	Ethidium bromide staining	<i>H. capsulatum</i>	Bracca et al. (2003)
Hc100	Tissues	PCR	Ethidium bromide staining	<i>H. capsulatum</i>	Bialek et al. (2002a)
Ag2/PRA	Tissues	Real Time	FRET	<i>Coccidioides posadasii</i>	Bialek et al. (2004)
Ag2/PRA	Tissues	PCR	Sequencing	<i>Coccidioides posadasii</i>	Bialek et al. 2004
WI-1	Tissues	PCR	Sequencing	<i>B. dermatitidis</i>	Bialek et al. 2003



hemodialysis (Blumberg et al. 2001), (9) bone marrow and solid-organ transplantation (Rüping et al. 2008), (10) recurrent or persistent gastrointestinal perforation (Eggimann et al. 1999), and (11) preterm delivery depending on gestational age and after birth intubation practices (Saiman et al. 2000; Wang et al. 2008).

### 17.6.1 Laboratory Diagnosis

The challenging diagnosis of *Candida* infections reflects the complexity of the diseases sustained by these species. Traditional microbiological techniques for diagnosis of invasive candidiasis often fail to detect *Candida* spp. as blood cultures are often negative or become positive too late. Efforts to develop reliable diagnostic tests have stimulated the development of several serological methods for the diagnosis of *Candida* infection. However, antibody detection in patients with candidiasis is of limited usefulness for three reasons: (1) colonization by *Candida* spp. of the gastrointestinal tract or other sites can elicit antibody responses in uninfected individuals; (2) immunocompromised patients may not mount detectable antibody responses even when they have deep *Candida* infections; (3) development of a significant antibody titer occurs too late during infection.

Morphologically, *Candida* spp. are thin walled and ovoid unicellular organisms (blastospores). Budding yeasts and pseudohyphae appear as Gram-positive. *Candida* organisms form smooth, creamy white, glistening colonies. Preliminary identification relies on Germ tube test, despite the fact that both false-positive and false-negative germ formation may occur (Sheppard et al. 2008). Traditional identification procedures are based on metabolic tests rather than on morphological characteristics (Wadlin et al. 1999). Because of variation in pathogenicity of individual species, accurate identification at the species level is highly recommended in clinical practice (Bishop et al. 2008; Sivakumar et al. 2009). In blood cultures, the growth kinetics may differ between *Candida* spp.: 1–3 days are necessary for *C. albicans*, *C. parapsilosis*, and *C. tropicalis* in standard medium, while growth of *C. krusei* and *C. glabrata* may take longer (Prevost and Bannister 1981). While candidemia would seem to be a key element of invasive candidiasis, retrospective studies have shown that blood cultures are positive in less than 50% of patients with autopsy-proven invasive candidiasis. (Rodriguez et al. 1996). Candiduria is common, especially in hospitalized patients having urinary catheters (Chen et al. 2008). However, neither the absolute colony count nor the presence or absence of white blood cells is pathognomonic (Navarro et al. 1997). It is particularly frequent to find *Candida* spp. in the respiratory tract of severely ill patients, but clinically relevant candidal pneumonia is quite rare and the presence of *Candida* spp. in the sputum has only a loose association with pneumonia (Rodriguez et al. 2000). Detection of *Candida* in CSF should always be regarded as pathognomonic of central nervous system (CNS) candidiasis.

Despite intense and long-lasting efforts, no serological test has yet been shown to have clinical applicability. Very recently, a test employing *Candida* cytoplasmic

antigens has been developed to measure circulating IgG, IgM, and IgA antibodies against *C. albicans* (Prince et al. 2008). Unlike the conventional antibody detection tests, the direct detection of *Candida* spp. antigens has been shown to have potential as an early diagnostic test. The Cand-Tec latex agglutination test (Ramco Laboratories,) was used as the first commercially available antigen detection test (Lemieux et al. 1990). However, the specificity and sensitivity of the Cand-Tec assay varied among reports (Phillips et al. 1990), and this test *per se* cannot establish a diagnosis of candidiasis. An alternative strategy is the detection of circulating  $\beta$ -(1-3)-D-glucan, a main cell wall component of *Candida*. High concentrations of  $\beta$ -(1-3)-D-glucan have been detected in patients with invasive candidiasis (Miyazaki et al. 1995a, b), and a commercial test is available (Fungitec G-test; Seikagaku Corporation). The detection of mannan antigenemia (mannanemia) for the immunodiagnosis of systemic candidiasis is widely used in patients with candidiasis, since positive mannan result may correlate with invasive candidiasis (Yeo and Wong 2002). Furthermore, correlation has been demonstrated between mannanemia and tissue invasion by *Candida* spp. in patients with candidemia, while mannanemia was less likely to be positive in patients with transient or central venous catheter-related candidemia (Girmenia et al. 1997). Two assays employing the anti-mannan EB-CA1 monoclonal antibody are marketed as the Pastorex Candida latex agglutination test (Bio-Rad) and the Platelia Candida Antigen test (a double-sandwich enzyme immunoassay by Bio-Rad) (Sendid et al. 1999). Although the specificities of these two assays are similar, the EIA is more sensitive than the latex agglutination test (Sendid et al. 1999). Despite the attempt to improve the immunodiagnostic detection of mannan, most assays, like the Pastorex latex agglutination test, still lack sensitivity due to the rapid serum clearance of the antigen.

### 17.6.2 Molecular Detection

The increasing incidence of *Candida* infections in immunocompromised patients (Cornely 2008) has focused attention on the exploitation of nucleic acids based techniques to set rapid and accurate diagnosis of IFI, independently from immunological-related markers. Nucleic acid hybridization and amplification methods provide both high detection rates and identification of *Candida* at the species level. This is increasingly important with the widespread use of antifungal therapy, and the problem of species-dependent resistance to antifungal agents in the genus *Candida* (Pfaller and Diekema 2004). Targets that are used in molecular diagnostic tests for *Candida* infections include both single and multicopy genes of nuclear and mitochondrial origin (Table 17.4). Among single copy genes of nuclear origin, actin, chitin synthase, cytochrome P450, and cytochrome P-450 lanosterol-14 $\alpha$ -demethylase (L1A1) have been exploited to detect *Candida* spp. by standard and nested-PCR from a wide set of clinical specimens including blood, serum, BAL, and body fluids (Kan 1993; Burgener-Kairuz et al. 1994; Chryssanthou et al. 1994; Jordan 1994) (Table 17.4). Species-specific restriction fragment length

Table 17.4 Main DNA-based assays for identification of *Candida* spp

Target DNA	Specimen	Method	Detection method	Specificity	References
Actin	Serum	PCR	Hybridization with radiolabeled probe	<i>Candida</i> spp.	Kan (1993)
Chitin synthase	Blood	PCR	Southern blotting	<i>Candida</i> spp.	Jordan (1994)
cytochrome P450	Serum	PCR	Ethidium bromide staining	<i>Candida albicans</i>	Chryssanthou et al. (1994)
cytochrome P-450 lanosterol-14 $\alpha$ -demethylase (L1A1)	Blood, deep pus, peritoneal fluid, pleural fluid, CSF, bile, urine, BAL	PCR	Southern blotting	<i>Candida</i> spp.	Burgener-Kairuz et al. (1994)
L1A1	BAL, blood	PCR-RFLP	Ethidium bromide staining/Southern blotting	<i>Candida</i> spp.	Morace et al. (1997)
L1A1	Blood	PCR-RFLP	Ethidium bromide staining	<i>Candida</i> spp.	Morace et al. (1999)
18S rRNA	Culture	PCR-RFLP	Ethidium bromide staining	<i>Candida</i> spp.	Hopfer et al. (1993)
HSP90	Swabs, urines, peritoneal fluid, pus, blood, serum	PCR-RFLP	Hybridization with radiolabeled probe	<i>C. albicans</i>	Crampin and Matthews (1993)
EO3,duplicated mitochondrial region	Blood	PCR	Ethidium bromide staining/Southern blotting	<i>C. albicans</i>	Miyakawa et al. (1993)
ITS	Serum	PCR-EIA	Enzyme immunoassay	<i>Candida</i> spp.	Burnie et al. (1997)
18S rRNA	Serum	PCR	Southern blotting	<i>Candida</i> spp.	Einsele et al. (1997)
ITS	Serum	PCR	Ethidium bromide staining	<i>Candida</i> spp.	Bougnoux et al. (1999)
25–28S rRNA	Culture	PCR	Sequencing	<i>Candida</i> spp.	Linton et al. (2007)
LSU D2/D1	Culture	PCR	Sequencing	<i>Candida</i> spp.	Sanguinetti et al. (2007)
ITS1-5.8S-ITS2, 25–28S rRNA	Culture	PCR	Sequencing	<i>Candida</i> spp.	Wise et al. (2007)
LSU D2	Culture	Rep-PCR	Microfluidics chip	<i>Candida</i> spp.	Hall et al. (2003)
Repetitive sequences	Culture	PCR	Sequencing	<i>Candida</i> spp.	
25–28S rRNA	Culture	PCR	Sequencing	<i>Candida</i> spp.	
LSU D2	Culture	PCR	Sequencing	<i>Candida</i> spp.	

(continued)

Table 17.4 (continued)

Target DNA	Specimen	Method	Detection method	Specificity	References
25-28S rRNA LSU D2	Culture	PCR	Sequencing	<i>Candida</i> spp.	Putignani et al. (2008a, b)
ITS1 and ITS2	Blood culture	PCR	Ethidium bromide staining	<i>Candida</i> spp.	Li et al. (2003)
ITS1 and ITS2	Blood culture	Multiplex-PCR	Ethidium bromide staining	<i>Candida</i> spp.	Chang et al. (2001)
EF3, CDC3, HIS3 microsatellite	Culture	Real-Time	Primer fluoro-labeling	<i>C. albicans</i>	Beretta et al. (2006)
M13 minisatellite	Culture	PCR	Ethidium bromide staining	<i>C. albicans</i>	Bartie et al. (2001)
ITS2	Culture	PCR	Pyrosequencing	<i>Candida</i> spp.	Boyanton et al. (2008)
25-28S rRNA LSU D2/D1	Culture	LAMP	LAMP amplicon DIG-labeling	<i>Candida</i> spp.	Inácio et al. (2008)
ITS	Blood culture	Real-Time <i>Sequifast</i>	Melting curve	<i>C. albicans</i> , <i>C. tropicalis</i> , <i>C. parapsilosis</i> , <i>C. krusei</i> , <i>C. glabrata</i>	Mancini et al. (2008)
ITS2	Blood culture	Real-Time	Melting curve	<i>Candida</i> spp.	Selvarangan et al. (2003)
RNA subunit of RNase P	Blood	Real-Time	TaqMan	<i>Candida</i> spp.	Innings et al. (2007)
ITS2	Blood	Real-Time	TaqMan	<i>Candida</i> spp.	Maaroufi et al. (2003)
ITS2	Culture	Real-Time	TaqMan	<i>Candida</i> spp.	Guiver et al. (2001)
18S rRNA	Blood culture	Real-Time	TaqMan	FLC-sensitive species ( <i>C. albicans</i> , <i>C. tropicalis</i> , <i>C. parapsilosis</i> , <i>C. dubliniensis</i> ) and FLC-resistant ( <i>C. glabrata</i> , <i>C. krusei</i> )	Metwally et al. (2007)
ITS1 and ITS2	Serum	Real-Time	Melting curve	<i>Candida</i> spp.	Dunyach et al. (2008)
18S rRNA gene	Culture	Real-Time	Melting curve	<i>Candida</i> spp.	White et al. (2004)

polymorphisms (RFLPs) have been identified in the L1A1 locus, making possible the identification of *Candida* species directly from DNA extracted from BAL and blood, even though traditional blood cultures and antigen detection assays were negative (Morace et al. 1997, 1999). Also HSP90 and ribosomal DNA RFLPs patterns have been exploited to perform identification of *C. albicans* and *Candida* spp. from clinical specimens (Crampin and Matthews 1993; Hopfer et al. 1993). Single-strand conformational polymorphisms of the 18S rDNA have provided differential profiles for *Candida* spp. and several yeast and mold species (Walsh et al. 1995).

Methods targeting multicopy genes offer lower detection limit in terms of number of fungal genomes. Among multicopy genes, mitochondrial DNA has been used in the PCR-based detection of *C. albicans* (Miyakawa et al. 1992) and *Candida* spp. (Yokoyama et al. 2000). However, the variability of mitochondrial DNA among different strains may be a limiting factor. Other studies have targeted the multicopy rDNA gene cluster with universal primer sets, in order to maximize sensitivity and specificity (Sandhu et al. 1995; Martin et al. 2000, Putignani et al. 2008a, b). As already discussed, the ribosomal genes contain conserved sequences that are common to all fungi (Figure 17.1), and which can be used to screen for yeast presence (Burnie et al. 1997; Einsele et al. 1997), while the variable ITS and LSU D2 sequences can be exploited for species identification (Linton et al. 2007; Sanguinetti et al. 2007; Putignani et al. 2008a, b). Indeed, the commercial MicroSeq D2 LSU rDNA Fungal Identification Kit can easily be applied to yeast identification (Hall et al. 2003). Since non-*albicans Candida* spp. are increasing in importance (Bille et al. 2005; Tavanti et al. 2005), broad-range diagnostic approaches capable of identifying a large number of *Candida* species are required (Table 17.4). The huge amount of sequencing data generated for the ribosomal 25–28S rDNA target have recently allowed molecular mycologists to compare between DNA-based identification procedures and classical diagnostic methods using large cohorts of patients and yeast isolates (Linton et al. 2007; Sanguinetti et al. 2007). New technologies, such as the pyrosequencing-based method, have recently been developed to perform identification of *Candida* spp. (Boyanton et al. 2008). Moreover, an innovative technique alternative to the PCR and based on isothermal DNA amplification, is providing highly performing identification of *Candida* (Inácio et al. 2008).

Repeated genome regions, dispersed through the fungal genomes, have also been considered to assess inter and intraspecies variability within the genus *Candida*. A real-time PCR study performed by using EF3, CDC3, and HIS3 microsatellite sequences provided an interesting example of genotyping clustering for cases of candidaemia in an intensive care unit (Beretta et al. 2006). Also a minisatellite-specific M13 primer was exploited to assess a mixed population of *C. albicans* strains in the oral microflora of patients affected by chronic hyperplastic candidosis (CHC) (Bartie et al. 2001). More recently, the DiversiLab rep-PCR-based system made it possible to identify and differentiate clinical isolates of *Candida* spp. (Wise et al. 2007). Most of the questions raised on the value of PCR assays for invasive aspergillosis apply also to disseminated candidosis (Bretagne and Costa 2005). The aim of several reports using PCR assays (Table 17.4) is to demonstrate the

superiority of PCR assays over blood cultures. The latter are known to be poorly (ca. 50%) sensitive, as previously discussed. A likely explanation is the low burden of circulating yeasts makes unlikely their sampling from blood. Therefore, the amplification of *Candida* DNA from blood raises the question whether the DNA comes from living *Candida* or it is naked DNA from lysed cells. If the aim of PCR assays is to improve the detection of viable *Candida* cells, this should be related to the sensitivity of blood culture, usually comprised between 1 and 150 CFU/mL (Einsele et al. 1997). With currently used DNA extraction kits, the input blood volume is usually 200  $\mu$ L. Thus, in order to obtain a PCR-positive result, at least ten *Candida* cells must be present in the 200  $\mu$ L tested (i.e., 50 cells/mL), since only 1/10th of the extracted material is loaded in the PCR reaction. Under these conditions, a blood culture performed with 10 mL of blood is expected to turn positive unless the *Candida* fails to grow because of antifungal treatment. If the amplified DNA comes from circulating naked DNA, as suggested by the better yield reported for serum than for blood (Burnie et al. 1997; Bougnoux et al. 1999), the sensitivity using multicopy genes as a target could reach higher sensitivity than 50 *Candida* cells/mL, probably below one *Candida* genome/mL assuming that the target is > 50 copies per cell, as in case of the rDNA. Indeed, the sensitivity of the real-time PCR (Light Cycler) system targeting the ITS was estimated ca. 1 cell/mL (White et al. 2003). However, the meaning of such a finding is less clear than a positive blood culture, especially in heavily colonized patients, as seen in ICUs, or patient under antifungal therapy. Another potential limit is the need to detect several *Candida* species, at least the five or six main species encountered in blood cultures (Tortorano et al. 2004). Thus, a good method should distinguish between most of the *Candida* spp. which are sensitive to fluconazole, and *C. glabrata* and *C. krusei* whose sensitivity is variable or null. Detection of anonymous yeasts in a pathological sample, without the knowledge of the involved species, cannot direct antifungal therapy until yeast identification. Therefore, to overpass the traditional culture on agar media, a real-time PCR assay should enable to detect and identify every *Candida* spp. even in polymicrobial association. The generation of new real-time PCR instruments which can simultaneously use up to four fluorogenic probes (as in the Light Cycler SeptiFast system) is a substantial advance in this direction. Another option is to associate PCR assays with a DNA-chip technology as in the rep-PCR DiversiLab system. As for *Aspergillus*, the use of real-time PCR should improve the reproducibility of the PCR tests and make comparison of the results from several studies feasible. The current assays are methodologically heterogeneous (Table 17.4). Recently, panfungal-primer based assays (Table 17.1) have also been applied to solve emerging clinical issues, as the detection of invasive candidosis in renal transplant recipients (Badiee et al. 2007) (Table 17.1).

## 17.7 *Coccidioides* spp.

*Coccidioides immitis* and *Coccidioides posadasii*, the only species included in the genus *Coccidioides*, are dimorphic fungi found in soil particularly in warm and dry areas with low rain fall, high summer temperatures, and low altitude. The two

species are morphologically identical but genetically and epidemiologically distinct (Fisher et al. 2001, 2002). *C. immitis* is geographically limited to California's San Joaquin valley region, whereas *C. posadasii* is found in the southwest of the United States, Mexico, and South America. Imported cases are observed following travel to endemic areas (Cairns et al. 2000). The two species co-exist in the southwest of the United States and Mexico. *Coccidioides* spp. are causative agent of coccidioidomycosis in humans. Coccidioidomycosis is a true systemic mycoses (Galgiani 1999), acquired by inhalation, and initially presents with a pulmonary infection which may later disseminate to other organs and systems. Airway coccidioidomycosis involving the endotracheal and endobronchial tissues may develop (Polesky et al. 1999). The clinical picture has a remarkably wide spectrum. The infection remains as an acute and self-limiting respiratory infection in most exposed individuals, but it can progress to a chronic and sometimes fatal disease in others. Spontaneous healing is observed in ca. 95% of the otherwise healthy individuals. Clinical presentations of coccidioidal infection are acute pneumonia, chronic progressive pneumonia, pulmonary nodules and cavities, extrapulmonary nonmeningeal disease, and meningitis (Chiller et al. 2003). Due to the true pathogenic nature of the fungus, coccidioidomycosis affects otherwise healthy, immunocompetent humans, although it may also affect immunocompromised patients, such as AIDS patients and organ transplant recipients (Medoff et al. 1992; Blair and Logan 2001). In fact, concurrent risk factors are HIV infection, organ transplant, hematologic malignancy and pregnancy (Powell et al. 1983). Coccidioidomycosis is a common cause of community-acquired pneumonia (CAP) in disease-endemic areas. However, because *Coccidioides* spp. testing among CAP patients is infrequent, reportable-disease data, which rely on positive diagnostic test results, greatly underestimate the true disease prevalence (Chang et al. 2008).

### 17.7.1 Laboratory Diagnosis

The diagnosis of coccidioidal infection can be traditionally made in three ways: (1) identification of coccidioidal spherules in a cytology or biopsy specimen, (2) culture from any body fluid that is positive for *Coccidioides* spp., or (3) a serologic test that is positive for the *Coccidioides* spp. Since *Coccidioides* does not colonize humans, the finding of spherules in tissue, sputum, bronchoalveolar lavage fluid, or other body fluid or a positive culture from any location in the body is pathognomonic of coccidioidal infection. For the safe isolation of *Coccidioides* spp., the laboratory should maintain a biological safety level 2 or 3. Serodiagnosis can be used to detect coccidioidal infection. Early immune response is characterized by the presence of IgM, which can be detected by a tube precipitin method, immunodiffusion, latex agglutination, or enzyme immunoassay (EIA). Latex agglutination and EIA are highly sensitive but are associated with false-positive results (Pappagianis 2001). These qualitative tests provide positive or negative results but no quantitative information. By comparison, complement fixation provides a quantitative titer that reflects the intensity of the immune response (Galgiani 1992).

### 17.7.2 *Molecular Detection*

Identification of coccidioidal elements in tissue sections can be very difficult or impossible (Kaufman et al. 1998). A successful approach to *C. immitis* detection in paraffin-embedded tissue sections is *in situ* hybridization. Hayden et al. (Hayden et al. 2001) described a set of oligonucleotide probes which identify and differentiate yeast like organisms in tissue sections. The *C. immitis*-specific probe had a sensitivity of 94.3%, a 100% specificity, and a positive predictive value of 100%. However, identification by this method is limited to cases with microscopically visible fungal elements. Stockman et al. (1993) showed a commercially available acridinium ester-labeled chemiluminescent DNA probe targeting the ribosomal RNA of *Coccidioides* spp. to be sensitive and 100% specific. A total of 164 strains from related and unrelated fungal species were tested to define specificity, and no cross-reaction was detected. The probe was developed for detection on spherule in tissue samples. Fixation in formaldehyde reduces efficiency of this excellent and widely used identification system (Gromadzki and Chaturvedi 2000). Nested PCR and a real-time PCR assays were recently developed to target the genus-specific antigen2/proline rich antigen of *Coccidioides* spp. (Bialek et al. 2004) (Table 17.3). Melting curve analysis by LightCycler and sequencing of the 526-bp product of the first PCR correctly identified all strains as *C. posadasii*. In addition, specific DNA was amplified by the conventional nested PCR from three microscopically spherule-positive paraffin-embedded tissue samples whereas 20 human samples positive for other dimorphic fungi remained negative (Bialek et al. 2004). Another LightCycler assay, targeting the ITS2 locus, allows identification of *Coccidioides* spp. from various respiratory specimens (Binnicker et al. 2007). Finally, a rep-PCR assay, binding to multiple noncoding, repetitive sequences interspersed throughout the genome, was exploited to test different *Coccidioides* spp. (Pounder et al. 2006) (Table 17.3). Distinction between *C. immitis* and *C. posadasii* species was assessed by designing appropriate coupled primers amplifying nucleotides 660.313–661.032 of *C. immitis* contig 2.2 (AAEC02000002, ([http://www.broad.mit.edu/annotation/fungi/coccidioides\\_immitis/](http://www.broad.mit.edu/annotation/fungi/coccidioides_immitis/))). This test discriminates *C. posadasii* from *C. immitis* for a 86-bp deletion (Umeyama et al. 2006).

### 17.8 *Cryptococcus neoformans*

Although more than 30 species are included in the genus *Cryptococcus*, only two of them are pathogenic: *Cryptococcus neoformans* and *Cryptococcus gattii* (Kwon-Chung et al. 2002). In the environment, *C. neoformans* is primarily found associated with fecal excretions from certain birds, such as pigeons, and in tree hollows. For years, *C. gattii* was found primarily in tropical and subtropical regions. It has been associated primarily with eucalyptus trees, which were considered its primary niche (Hull and Heitman 2002). These species were previously classified as three



varieties: *C. neoformans* var *neoformans*, *C. neoformans* var *grubii*, and *C. neoformans* var *gattii* (Franzot et al. 1999), which were classified into five capsular serotypes: A, D, and the hybrid diploid AD belonging to the *C. neoformans*, with serotype A named *C. neoformans* var *grubii*, and serotype D named *C. neoformans* var *neoformans*; and serotype B and C classified as *C. gattii* (Franzot et al. 1999) and eight molecular genotypes (VNI through VNIV for *C. neoformans* and VGI through VGIV for *C. gattii*) (Meyer et al. 2003). Principal predisposing factors for cryptococcosis are HIV infection, treatment with corticosteroids, solid organ transplantation with immunosuppressive therapies, malignancies, CD4<sup>+</sup> T-cell lymphopenia, connective tissue diseases or immunologic diseases, diabetes mellitus, chronic pulmonary diseases or lung cancer, renal failure or peritoneal dialysis, cirrhosis and pregnancy (Perfect and Casadevall 2002). Before the HIV epidemic, cryptococcal infection was an uncommon systemic fungal infection that occurred primarily in patients who had impaired immunity (Mitchell and Perfect 1995). However, during the past two decades of the HIV epidemic, the incidence of cryptococcosis increased dramatically. Before the development of the “highly active antiretroviral therapy” (HAART), cryptococcal infection was regarded as the major cause for morbidity and mortality in HIV-infected patients with CD4 lymphocyte counts < 100 cells/μL. However, in the HAART era, the incidence of cryptococcosis decreased significantly in HIV patients, although remaining constant in non-HIV individuals (Friedman et al. 2005). A recent clinical syndrome associated with HAART-driven immune reconstitution in HIV patients is “the immune reconstitution inflammatory syndrome” (IRIS). IRIS has been reported to occur in 30–35% of HIV patients with a history of cryptococcosis in whom HAART was initiated (Perfect and Casadevall 2002). Patients infected with HIV who have cryptococcal meningitis and IRIS have a greater fungal burden, as indicated by higher CSF antigen titer and the presence of disseminated infection or fungemia. Nevertheless, cryptococci are hardly culturable from these patients, and molecular diagnosis is recommended (Putignani et al. 2008a, b). Similar to patients infected with HIV, those who have undergone solid organ transplantation and having higher cryptococcal antigen titers with disseminated disease are more likely to develop IRIS after initiation of antifungal therapy (Singh et al. 2005). Cryptococcosis is the third most common invasive fungal infection after candidiasis and aspergillosis in patients undergoing solid organ transplantation (Vilchez et al. 2002). The CNS and respiratory tract are the most plagued organs by *C. neoformans* and *C. gattii* infections.

### 17.8.1 Laboratory Diagnosis

Traditionally, diagnosis of cryptococcosis depends on *Cryptococcus* culture or on the demonstration of encapsulated yeasts in India ink-stained pathological samples. Direct microscopy and culture are specific but the sensitivity is poor (50–80%) (Snow et al. 1975). Although culture remains the “gold standard” for diagnosis, it

is cumbersome, labor intensive, and time consuming because of the slow growth of cryptococci. On the other hand, negative cultures may occur despite positive India ink examinations because of nonviable yeast cells that may have prolonged persistence at the infection site (Putignani et al. 2008a, b). Serology is an indirect and adjunct or complementary procedure to support clinical diagnosis, especially when the patient is on treatment. Antigen detection still represents the fastest and simplest diagnostic tool. Detection of cryptococcal capsular polysaccharide antigen in serum or body fluids has performed robustly for many years. The main component of the *C. neoformans* capsular polysaccharide is a glucuronoxylomannan (GXM). Antigenic structures intrinsic to the GXM allow the distinction between serotypes. An important tool in the diagnosis of cryptococcosis is the latex particle agglutination test (LAT, e.g., Cryptococcus-Antigen Latex-Agglutination System; CALAS, Meridian Bioscience Inc.), which uses latex particles coated with an anti-GXM antibody to detect capsular polysaccharide antigen in serum or CSF. LAT is the most commonly used serological method due to its simplicity in performance (Hamilton et al. 1991; Kiska et al. 1994), although suffering from false positivity and difficulty of interpretation in borderline cases (Whittier et al. 1994; Millon et al. 1995). Enzyme immunoassay (EIA, e.g., PREMIER Cryptococcal Antigen Kit; Meridian Bioscience) is another serological tool for detection of capsular polysaccharide antigens of *C. neoformans* in CSF. This is a rapid test that provides visual and numeric result in less than an hour without pre-treatment of the specimen (Saha et al. 2008).

### 17.8.2 Molecular Detection

Various DNA extraction procedures have been published for efficient disruption of cryptococcal cells, including enzyme digestion or glass beads (Tanaka et al. 1996), and a number of PCR assays have successfully been applied to diagnose cryptococcal disease starting from a variety of clinical specimens, such as blood, liquor, secretions, cutaneous scrapings, bronchial alveolar aspirate, and urine. These PCR assays use primers targeting the 18S, 28S, or the ITS and 5.8S rDNA, eventually coupled with species-specific probes (Mitchell et al. 1994; Sandhu et al. 1995; Prariyachatigul et al. 1996; Rappelli et al. 1998; Kano et al. 2001; Bialek et al. 2002b; Iyer and Banker 2002; Takahashi et al. 2003; Pagano et al. 2004; Paschoal et al. 2004; Putignani et al. 2008a, b) (Table 17.5). Unique primers named CN4, CN5, and CN6, have been developed to amplify the 5.8S and ITS regions of *C. neoformans* rDNA, and used with different clinical specimens (Mitchell et al. 1994). Rappelli et al. (1998) set up a nested PCR assay on the ITS region of *C. neoformans* directly in CSF specimens, followed by visual detection in agarose gels (Rappelli et al. 1998). This method was improved by Paschoal et al. (2004), who shortened the time for *C. neoformans* detection and identification from CSF samples by entailing just a single step for the amplification. The results demonstrated that PCR had the highest sensitivity rate (92.9%), superior to culture (85.7%) and to India ink test (76.8%) (Paschoal et al. 2004). Rapid cycling

**Table 17.5** Main DNA-based assays for identification of *C. neoformans*

Target DNA	Specimen	Method	Detection method	References
18S rRNA	Tissues	PCR	Sequencing	Bialek et al. (2002b)
18S rRNA	Tissues	Real Time	Real time (FRET)	Bialek et al. (2002b)
18S rRNA	CSF	PCR	Southern hybridization	Prariyachatigul et al. (1996)
18S rRNA	Culture	PCR	Ethidium bromide staining	Mitchell et al. (1994)
ITS2	CSF	PCR	Ethidium bromide staining	Rappelli et al. (1998)
ITS2	Lymph node aspirate	PCR	Ethidium bromide staining	Putignani et al. (2008a, b)
ITS2	Respiratory (BAL)	PCR	Sequencing	Takahashi et al. (2003)
25–28S rRNA LSU D2	Culture	PCR	Sequencing	Putignani et al. (2008a, b)
ITS5.8S rRNA	CSF	PCR	Ethidium bromide staining	Paschoal et al. (2004)
CAP59	Tissues	PCR	Ethidium bromide staining	Kano et al. (2001)
URA5	Respiratory and tissues	PCR	Ethidium bromide staining	Tanaka et al. (1996)

real-time PCR protocols further simplified the diagnostic laboratory workflow and reduced the possibility of product contaminations (Bialek et al. 2002b; Bergman et al. 2007). Bialek et al. (2002b) established two PCR protocols targeting the 18S rRNA gene of *C. neoformans*. One protocol was designed as a nested PCR to be performed in conventional thermal cyclers. However, to minimize the event of false-positive results, amplicons should be sequenced for an unambiguous species identification. The other protocol was designed as a quantitative single-round PCR adapted to LightCycler technology (Bialek et al. 2002b) which avoids amplicon verification by means of Southern blotting or DNA sequencing. Once DNA is extracted from suitable specimens and reaction mixtures are completed, the results of sensitive and quantitative PCR are available within 60 min (Bialek et al. 2002b). A simple PCR-based method for *C. neoformans* serotyping strains, which uses a set of four primers for the laccase (LAC1) gene has recently been developed (Ito-Kuwa et al. 2007). This primer combination differentiates serotypes A, D, B, and C. Further differentiation between serotypes AD and D requires the use of a primer pair to the capsule (CAP64) gene. When multiplex PCR is performed with all of the above six primers, the five serotypes generate distinct fingerprints composed of two to five fragments. Genotype-based differentiation of the *C. neoformans* serotypes can further be achieved by combining PCR-RFLP analysis of the CAP10 and CAP59 genes (Raimondi et al. 2007). A reverse line blot hybridization panfungal assay for identification of *C. neoformans* isolates is also available (Zeng et al. 2007) (Table 17.1).

## 17.9 Dematiaceous Fungi

Chromoblastomycosis, mycetoma, and phaeohyphomycosis are fungal infections caused by dematiaceous (darkly-pigmented) fungi, a group of organism usually found in the soil (Revankar et al. 2002). Chromoblastomycosis, a chronic infection of skin and subcutaneous tissues, is most commonly seen in tropical areas with most cases caused by *Fonsecaea pedrosoi* followed by *Fonsecaea compacta*, *Phialophora verrucosa*, *Cladophialophora carrionii*, and *Rhinocladiella aquaspersa* (Revankar et al. 2002, Sanche et al. 2003). Infection typically occurs via traumatic implantation in exposed surfaces of the legs (Milam and Fenske 1989). Mycetoma, also known as Madura's foot, is also a chronic infection of cutaneous and subcutaneous tissues, caused by *Madurella mycetomatis*, *Madurella grisea*, *Curvularia lunata*, *Exophiala jeanselmei*, and *Leptosphaeria senegalensis* (Sanche et al. 2003). Chromoblastomycosis and mycetoma are considered types of phaeohyphomycoses, which can also include corneal, systemic infections, and fulminant disseminated disease (Revankar et al. 2002; Sanche et al. 2003). Over 100 species have been implicated in phaeohyphomycoses (Revankar et al. 2002). Genera associated with pneumonia include *Ochroconis*, *Exophiala*, and *Chaetomium* (Revankar et al. 2004) while *Scedosporium* (e.g., *S. prolificans*) and, to a lesser extent, *Bipolaris* and *Wangiella* produce disseminated disease (Revankar et al. 2002, 2004). Genera associated with CNS infection include *Cladophialophora* (e.g., *C. bantiana*), *Ramichloridium* (e.g., *R. mackenzii*), and *Ochroconis* (Kantarcioglu and de Hoog 2004; Revankar et al. 2004; Revankar 2006). In contrast to other IFIs, underlying immunodeficiency is not a prerequisite for phaeohyphomycoses, although some immune dysfunction is associated with disseminated disease (Revankar et al. 2002). Mortality rates are high regardless of the patient's immune status; however, recovery from neutropenia is considered critical for patients with *S. prolificans* infection (Revankar et al. 2002). No risk factors have been identified in many patients (Kantarcioglu and de Hoog 2004; Revankar et al. 2004). However, CNS disease is generally correlated to cellular immune dysfunction while disseminated disease to malignancy, neutropenia, HSCT, solid organ transplant (SOT), HIV, and catheterism (Cornely 2008).

### 17.9.1 Laboratory Diagnosis

Classical methods are based on 20% potassium hydroxide microscopy, histopathological confirmation of sclerotic cells by periodic acid-Schiff stain, culture on Sabouraud's glucose agar, slide culture method, and observation of conidia by scanning electron microscopic examination (Hospenthal 1995).

### 17.9.2 Molecular Detection

DNA-based techniques have recently been employed to identify the causative agents of chromoblastomycosis (Vidal et al. 2004; Piepenbring et al. 2007;

Chowdhary et al. 2008; Miyagi et al. 2008). PCR of the ITS and direct sequence analysis of the amplicon, coupled with classical detection methods proved effective in identification of the causative agent of chromoblastomycosis as *Fonsecaea pedrosoi* (Miyagi et al. 2008). By means of 18S rDNA sequencing and GenBank database homology searches, a rare case of chromoblastomycosis in a renal transplant recipient caused by a nonsporulating fungal isolate belonging to genus *Rhynchostyria* was successfully diagnosed (Chowdhary et al. 2008).

## 17.10 *Fusarium* spp.

Fusariosis is a life-threatening mycosis in immunocompromised hosts (Lionakis and Kontoyiannis 2004). *Fusarium* spp. are angiotropic and angioinvasive molds that produce hemorrhagic infarction and low tissue perfusion, resulting in tissue necrosis (Lionakis and Kontoyiannis 2004). More than 50 species of *Fusarium* have been identified but only a few are pathogenic in humans (Lionakis and Kontoyiannis 2004). These include *F. solani* (causes ~ 50% of cases), *Fusarium oxysporum*, *Fusarium moniliforme*, *Fusarium verticillioides*, *Fusarium dimerum*, and *Fusarium proliferatum* (Lionakis and Kontoyiannis 2004). In terms of global occurrence, fusariosis is most common in the United States (50–80% of all fusariosis cases), followed by France, Italy, and Brazil (Torres et al. 2003). Invasive fusariosis has emerged in many tertiary-care cancer centers as the second most common invasive mold infection (after invasive aspergillosis) in severely immunocompromised patients (Lionakis and Kontoyiannis 2004). A steady rise in the number of cases of fusariosis in hematopoietic stem cell transplant recipients has been observed since the late 1980s (Nucci et al. 2004). More than 90% of cases of fusariosis have been reported in neutropenic patients with hematologic malignancies (Lionakis and Kontoyiannis 2004) and autologous bone marrow transplant recipients (Boutati and Anaissie 1997). Because the clinical presentation of fusariosis is rather unspecific, differentiation from invasive aspergillosis can be challenging (Torres et al. 2003; Lionakis and Kontoyiannis 2004).

### 17.10.1 *Laboratory Diagnosis*

*Fusarium* spp. grow easily and rapidly in most mycological media. Although the genus *Fusarium* can be identified by the production of hyaline, banana-shaped, multicellular macroconidia with a foot cell at the base, interpretation of the growth of *Fusarium* spp. from different biological materials depends on the clinical context. The clinician and the microbiologist must be cautious, because *Fusarium* spp. may contaminate laboratory specimens and pseudo-outbreaks of fusariosis may occur (Grigis et al. 2000). In support of infection are the isolation of several colonies from the same specimen or of the same fungus from different specimens of the same patient, the site of isolation, and, most importantly, a positive direct examination of the biological material. Histopathology is therefore recommended

for a confirmatory diagnosis of fusariosis. In tissues, the hyphae of *Fusarium* are similar to those of *Aspergillus* spp. (hyaline and septate filaments). However, adventitious sporulation may be present in tissue, and the finding of both hyphae and yeast-like structures is highly suggestive of fusariosis in the high-risk population. In the absence of microbial growth, distinguishing fusariosis from other hyalohyphomycoses may be difficult and requires the use of molecular techniques.

### **17.10.2 Molecular Detection**

A fluorescent-based PCR assay which allows rapid and reliable identification of five toxigenic and pathogenic *Fusarium* spp., namely *Fusarium avenaceum*, *F. culmorum*, *F. equiseti*, *F. oxysporum*, and *F. sambucinum* has been developed (Mishra et al. 2003). This method is based on amplification of species-specific ITS using fluorescent oligonucleotide primers, which were designed on sequence divergence within the rDNA. Besides providing an accurate, reliable, and rapid identification of these *Fusarium* spp., it reduces the potential for exposure to carcinogenic chemicals as it substitutes ethidium bromide staining of amplicons with the use of fluorescent dyes (Mishra et al. 2003). Molecular diagnosis of the toxigenic *Fusarium* spp. has recently been developed in a PCR assays for genes involved in the toxin biosynthesis (Mulè et al. 2005). The method allows early detection of toxin-producing *Fusarium* spp, and reveals which particular toxin may be present in a feed product (Mulè et al. 2005). A DNA microarray was assembled to detect and identify DNA from 14 fungal pathogens including *F. oxysporum* and *F. solani* in blood, BAL, and tissue samples from high-risk patients. The assay combines multiplex PCR and consecutive DNA microarray hybridization. PCR primers and capture probes were derived from unique sequences of the 18S, 5.8S, and ITS1 regions of the fungal rRNA genes. Hybridization with genomic DNA of fungal species resulted in species-specific hybridization patterns (Spiess et al. 2007).

### **17.11 *Histoplasma capsulatum***

*H. capsulatum* is a dimorphic fungus that, although worldwide distributed, is more prevalent in certain regions of north and central America (Wheat and Kauffman 2003). Manifestations of histoplasmosis range from asymptomatic to severe and fatal disease, depending on the immune status and the magnitude of exposure (Wheat and Kauffman 2003). Disseminated disease occurs in approximately 10% of all infections (Wheat and Kauffman 2003). CNS involvement is the presenting manifestation in 5–10% of disseminated disease cases (Wheat and Kauffman 2003). Although histoplasmosis is relatively uncommon among transplant patients, outbreaks of the disease have been reported in transplant centers with incidence rates of ca. 2% (Freifeld et al. 2005). While immunocompetent adults with disseminated histoplasmosis typically have a chronic progressive course of the disease, those who are severely immunosuppressed can have an acute course with fatal outcome.

### 17.11.1 Laboratory Diagnosis

Since the clinical picture of histoplasmosis strongly mimics those of tuberculosis and some other lung diseases, it is not possible to confirm a diagnosis of pulmonary histoplasmosis on the sole basis of the clinical symptoms (Bracca et al. 2003). Confirmatory diagnosis requires culture, fungal stain of tissue or body fluids, and tests for antibodies and antigens, depending on the extent and severity of infection (Wheat 2003).

Microscopic identification of *Histoplasma* in May-Grünwald-Giemsa-stained slides is an acceptable approach, but an experienced operator is needed to obtain reliable results. The fungus can be cultured from different clinical samples such as blood, bone marrow, respiratory secretions, or localized skin lesions (Wheat 2003). Isolation of the organism from cultures provides the strongest evidence for infection with *H. capsulatum*, but has some limitations. First, growth of *H. capsulatum* in culture is slow, requiring up to 4 weeks, causing undesirable delay in the diagnosis and therapy. Second, invasive procedures might be required to obtain specimens for culture. Bone marrow cultures yield the highest frequency of positive isolations (70–90%), while respiratory specimens yield positive results less frequently (50–90%). Third, cultures are negative in most patients with mild forms of histoplasmosis, limiting its use for diagnosis in mild cases. Cultures are positive primarily in patients with disseminated or chronic pulmonary histoplasmosis, but even in these patients cultures can be falsely negative in about 20% of disseminated histoplasmosis and 50% of chronic pulmonary diseases (Wheat 2003). Serological methods are faster than culture, but they can lead to false-positive results because the titer of specific antibodies against *Histoplasma* remains high for months or years after the primary infection (Bullok 1995). In addition, cross-reactivity against *P. brasiliensis* can give false positive results (Raman et al. 1990). On the other hand, false-negative results due to low antibody titers can be observed in immunocompromised patients with active infection (Wheat et al. 1992). An alternative is the detection of *H. capsulatum* antigen in body fluids (Gomez et al. 1997). Although this method is more sensitive than serum antibody detection assays, cross-reactivity against antigens of other pathogenic fungi remains a problem (Wheat et al. 2002).

### 17.11.2 Molecular Detection

A variety of PCR and DNA probes have been applied to the detection of *H. capsulatum* DNA in tissues and body fluids (Sandhu et al. 1995; Bialek et al. 2005a; Rickerts et al. 2002; Bracca et al. 2003; Martagon-Villamil et al. 2003). A seminested PCR for the diagnosis of histoplasmosis that amplifies a portion of the *H. capsulatum* H antigen gene has been developed. This assay is sensitive and specific, being able to detect genomic material corresponding to less than ten yeast cells without cross-reaction against other bacterial or fungal pathogens (Bracca



et al. 2003). The real-time PCR assay for *H. capsulatum* can be used for the confirmation of culture isolates suspected to be *H. capsulatum*, and potentially to test clinical specimens directly (Martagon-Villamil et al. 2003). A rep-PCR assay, targeting multiple noncoding, repetitive sequences (generally 30–500 bp) interspersed throughout the fungal genome, was exploited to differentiate isolates of *H. capsulatum*, according to the procedure previously described for *B. dermatitidis* (Pounder et al. 2006) (Table 17.3).

## 17.12 *Trichosporon* spp.

Trichosporonosis is a relatively uncommon opportunistic fungal infection in immunocompromised individuals, often resulting in fatal outcome (Girmenia et al. 2005). The taxonomy of the yeasts that causes trichosporonosis has recently been revised. It is now widely accepted that the previously named *T. beigeli* consists actually of six species: *Trichosporon asahii*, *Trichosporon asteroides*, *Trichosporon cutaneum*, *Trichosporon inkin*, *Trichosporon mucoides*, and *Trichosporon ovoides*. *Geotrichum capitatum*, originally included in genus *Trichosporon*, has been classified as *Blastoschizomyces capitatus*, whose *Dipodascus capitatus* is the teleomorph stage. *B. capitatus* is also a common cause of trichosporonosis (Girmenia et al. 2005) and has recently been characterized as an outbreak agent (Ersoz et al. 2004). Case reports of invasive trichosporonosis have frequently been reported, and *Trichosporon* and *Blastoschizomyces* are currently considered the second most common yeasts causing disseminated infections after *Candida* spp. (Chagas-Neto et al. 2008). Trichosporonosis is an acute, febrile, severe infection with dissemination to multiple deep organs, associated with up to 64% mortality (Chagas-Neto et al. 2008). While any immunocompromised patient can develop trichosporonosis, the risk is highest for those with hematologic malignancies, followed by neutropenia, peritoneal dialysis, solid tumor, SOT, burns, and prosthetic cardiac valve (Girmenia et al. 2005). Incidence rates of 0.4% and 0.5%, respectively, for infections due to *Trichosporon* spp. and *G. capitatum* have been reported in patients with leukemia (Girmenia et al. 2005). *Trichosporon* spp. are resistant to echinocandins, as demonstrated by breakthrough trichosporonosis in immunocompromised patients treated with caspofungin or micafungin (Cornely 2008). *Trichosporon* infection should be suspected in immunocompromised patients who are being treated with echinocandins and develop signs of septicemia or local infection.

### 17.12.1 Laboratory Diagnosis

A firm diagnosis of deep-seated trichosporonosis should result from histological examination of tissue samples obtained by biopsy and culture of living *Trichosporon* cells. However, invasive examinations, such as biopsy, cannot repeatedly be



performed in patients with severe underlying diseases, and even though the detection of causative fungi in the blood is clinically valuable, the results of blood cultures usually become available after a long time. Patients with disseminated trichosporonosis may test positive for the GXM antigen (Melcher et al. 1991) or (1 → 3)-β-D-glucan (Miyazaki et al. 1995a, b). However, patients with other mycoses also test positive in these assays, and therefore the specificity of these tests is unsatisfactory (Miyazaki et al. 1995a, b).

### 17.12.2 Molecular Detection

Sugita et al. (1999) developed an accurate identification system for all the species in the genus *Trichosporon*, including the six medically relevant species, based on comparative sequence analysis of the ITS regions. Furthermore, the same authors described a nested PCR assay for species-specific detection of *T. asahii*, which is the major causative agent for deep-seated infection (Sugita et al. 2001) (Table 17.3). Recently, DNA-based procedures for the identification of *Trichosporon* have been stepped up by the sequence analysis of the rRNA ITS1, which better distinguishes between sibling species (Table 17.3). Quantification of *Trichosporon* spp. in clinical samples is of great clinical significance. A quantitative real-time PCR assay to detect *T. asahii* DNA from the blood sample of trichosporonosis patients was recently developed (Mekha et al. 2007). The specific primer/probe system was capable of detecting *T. asahii* DNA in all samples from trichosporonosis patients, showing higher sensitivity than polysaccharide antigen detection (Table 17.3).

## 17.13 Zygomycetes

Zygomycosis is an increasingly important IFI caused by emerging pathogens belonging to the Zygomycetes class, which can be subdivided into two orders: Mucorales and Entomophthorales (Ribes et al. 2000). The most common species of Mucorales causing angioinvasive zygomycosis are *Rhizopus arrhizus* (syn. *Rhizopus oryzae*), *Rhizopus microsporus* var. *rhizopodiformis*, and *Rhizomucor pusillus*. Other causative species include *Absidia corymbifera*, *Mucor* spp., and *Cunninghamella bertholletiae* (Chayakulkeeree et al. 2006). Human disease is most commonly caused by Mucorales, which are characterized by rapidly evolving course, tissue destruction, and invasion of blood vessels (Chayakulkeeree et al. 2006). Mycoses caused by Entomophthorales are more indolent and chronically progressive (Chayakulkeeree et al. 2006). The most common types of infection are sinus, pulmonary, and cutaneous; disseminated disease is reported in approximately one-fourth of patients (Roden et al. 2005). Iron overload predisposes to zygomycosis (Gonzalez et al. 2002). Mucorales are distributed worldwide, while Entomophthorales are generally limited to the tropics and subtropics (Gonzalez et al.

2002). Notably, there has been a steady increase in reported cases of zygomycosis over the last 60 years (Roden et al. 2005). Diabetic patients, particularly those with ketoacidosis, are highly susceptible to zygomycosis (Chayakulkeeree et al. 2006). Other risk factors are neutropenia, corticosteroid use, HSCT, SOT, HIV, drug use, skin or soft tissue breakdown (e.g., burn, traumatic inoculation, surgical wounds), prematurity, malnourishment, malignancy, and long-term prophylaxis with voriconazole.

### **17.13.1 Laboratory Diagnosis**

The traditional diagnosis of zygomycosis is based upon identification of broad, ribbon-like, pauciseptate hyphae by histopathology, or the use of macroscopic and microscopic morphology analysis following fungal culture (Gonzalez et al. 2002). Histopathology determinations suffer from subjectivity that is dependent upon the experience of the reader. In addition, tissue processing, fixation, and staining may require several days (Frater et al. 2001). When culture is used, the distinctive hyphal elements of zygomycetes are difficult to distinguish from those of other filamentous fungi, especially at early growth stages. Although the zygomycetes grow quite rapidly on solid media, sporulation and identification may still take several days. In addition, when a zygomycetous infection is not specifically suspected at the time of specimen submission, tissues may undergo extensive processing prior to culture, which ruptures the pauciseptate hyphae. It is therefore not unusual to have negative fungal culture results when histopathology results suggest the presence of zygomycosis (Kontoyiannis et al. 2000).

### **17.13.2 Molecular Detection**

DNA-based molecular techniques have an enormous potential for rapidly and accurately identifying the agents of zygomycoses. A molecular approach for the detection of Zygomycete molds may increase sensitivity and rapid diagnosis, resulting in earlier, directed therapy. Several reports describe utilization of universal fungal primers from the 18S rDNA or the ITS region for PCR amplification, followed by amplicon sequencing (Kobayashi et al. 2004; Schwarz et al. 2006) or hybridization to specific probes (Einsele et al. 1997, Rickerts et al. 2001). Also a seminested PCR assay targeting the 18S rDNA of Zygomycetes, followed by sequencing of the amplified product has been developed, providing sufficient sensitivity for fungal detection in paraffin-embedded tissues (Bialek et al. 2005a) (Table 17.3). A multiplex PCR method designed to yield different sized PCR products from the ITS region, whose length and combination correlates with four *Rhizopus* spp., provided detection of DNA from paraffin-embedded tissues and blood taken from a single patient (Nagao et al. 2005). Another assay uses a mixture of four genus-specific sense primers coupled with one degenerate antisense primer

from the 18S rDNA to detect the four major genera within the Mucorales. RFLP of the amplicon makes possible species-level identification (Machouart et al. 2006). Kontoyiannis et al. (2005) used sequence-based identification to characterize the distribution of the various genera among clinical isolates of Zygomycetes. ITS sequencing identified the genus in almost all of their isolates (Kontoyiannis et al. 2005). They also showed that the results of ITS sequencing were > 20% discordant with those of morphological identification, and that most of the morphologically misidentified Zygomycetes isolates belonged to *Rhizopus* spp. (Kontoyiannis et al. 2005). More recent studies reported the use of real-time PCR assays for detection of infections caused by Zygomycetes. One study utilized a conserved region of the zygomycete cytochrome b gene as target (Hata et al. 2008). The second study was aimed at identifying the most common species of Zygomycetes causing human disease, using the 28S rRNA gene as target. The first assay (qPCR-1) detects *Rhizopus*, *Mucor*, and *Rhizomucor* spp. and the second assay (qPCR-2) detects *Cunninghamella* spp. Both assays utilize fluorescence resonance energy transfer (FRET) hybridization probes for detection of species within the genera (Kasai et al. 2008).

## 17.14 Dermatophytes

The dermatophytes are a group of closely related fungi that have the ability to invade the stratum corneum of the epidermis and keratinized tissues (keratinophilic fungi), such as the skin, nail, and hair of humans and animals. Many dermatophytes are saprophytic soil fungi (geophilic), without any pathogenic feature for humans and animals and other only animals (zoophilic). Because zoophilic dermatophytes, through zoonotic transmission, infect humans only rarely and geophilic dermatophytes are infrequent cause of human disease, we will mainly focus on anthropophilic dermatophytes. These fungi cause dermatophytoses at most skin sites, although the feet, groin, scalp, and nails are most commonly affected. There are three genera of pathogenic anthropophilic dermatophytes, *Trichophyton*, *Microsporum*, and *Epidermophyton*. The last genus is represented by the single species *Epidermophyton floccosum*. Most of the 39 dermatophyte species are parasitic, causing disease in either humans and animals with mechanisms of narrow host range of adaptation (Hay 1995). The taxonomy of these fungi is complicated by the fact that most clinical isolates are imperfect fungi, organisms that do not produce sexual structures in culture. It is important for these fungi the strain differentiation within the same species to understand spreading of infections and relapse, quite frequent after apparently successful treatment (Abdel-Rahman 2008). Anthropophilic dermatophytes are the most common cause of human dermatophytosis (generally referred as ringworm or tinea corporis) as well as tinea pedis or tinea cruris, all of them belonging to the so-called superficial fungal infections (Kanbe 2008). Dermatophytoses are generally restricted to the cutaneous and the nonliving corneum layers due to host defense responses to the invading fungi in

immunopotent individuals (Ogawa et al. 1998). In immunocompromised individuals, infection may progress to deep cutaneous and subcutaneous sites (Kanbe 2008). Dermatophytes are the most common causes of skin disease in tropical countries. *Trichophyton rubrum* is probably the most prevalent agent of dermatophytosis throughout the world (Veer et al. 2007).

### **17.14.1 Laboratory Diagnosis**

The morphological similarity, variability, and polymorphism of dermatophytes have meant that species identification for dermatophytes is time consuming and requires significant expertise. Furthermore, the application of chemotherapy has also contributed to the occasional modification and alteration of the morphological features of dermatophytes, resulting in atypical colonial growth and appearance and complicating laboratory identification procedures based on phenotypic features.

### **17.14.2 Molecular Detection**

Molecular analyzes of dermatophyte genomes would clear several problems in the traditional morphology-based taxonomy (Kanbe 2008). With these expectations, many investigators have focused their research on the nucleic acids of dermatophytes. The G + C content of chromosomal DNA isolated from species belonging to genera, *Trichophyton*, *Microsporum*, and *Epidermophyton* is 48.7–50.3%, a narrow range when compared with the 48–61% range reported in the single genus *Aspergillus*. This indicates a genetic homogeneity among dermatophytes as opposite to their phenotypic and ecological variation (Davidson et al. 1980). Subsequently many investigators have focused on mitochondrial DNA (mtDNA) and rDNA of dermatophytes to determine the phylogenetic relationships among dermatophytic species. These data have widely contributed to the development of molecular techniques for the identification and epidemiology of dermatophytes, as reviewed by Kanbe (2008), Blanz et al. (2000) and Kac (2000). PCR and PCR-RFLP-based techniques made it possible to identify dermatophytes to species level, and to discriminate between isolates at the strain level (Makimura et al. 1999; Gräser et al. 2000; Liu et al. 2002). DNA samples obtained from fungal cultures or clinical specimens can be amplified by three primer sets targeting the 18S rDNA and ITS regions (TR1/TR2 and B2F/B4R for 18S rDNA and ITS1/ITS2 for ITS regions), yielding species-specific products from the ITS regions of *Trichophyton*, *Microsporum*, or *Candida* species (Turin et al. 2000). PCR-RFLP targeting both the ITS and NTS regions provides a valuable tool for species identification of dermatophytes (Jackson et al. 1999). The ITS is amplified with a universal primer set for 17 common dermatophyte species, and further RFLP with *MvaI* allows to discriminate between the majority of the dermatophytes at the species level, except for the sibling species of *T. rubrum/Trichophyton soudanense* and *Trichophyton*

*quinkeanum/Trichophyton schoenleii*. On the basis of RFLP profiles of the NTS region, *T. rubrum* can be subdivided into 14 types (Jackson et al. 1999). Similarly, Mochizuki et al. (2003) described the identification of *T. tonsurans* by PCR-RFLP targeting the ITS region, and *MvaI* or *HinfI* digestion. The RFLP profile obtained with *MvaI* was distinctive of *T. tonsurans* and different from that of other dermatophyte species (Mochizuki et al. 2003). Recently, Yoshida et al. (2006) reported on a PCR-based identification of *T. tonsurans*, in which the *T. tonsurans* genomic DNA was amplified by primers specific to the ITS1 region of this fungus. This method was able to discriminate *T. tonsurans* from other fungal species involved in dermatophytosis using only a single PCR amplification step (Yoshida et al. 2006). Real-time PCR with LightCycler has been combined with RFLP for the rapid detection/identification of isolates of dermatophytes and other pathogenic fungi in clinical specimens. Dermatophytes were distinguished from nondermatophytes using the LightCycler melting points. However, restriction enzyme digestion of the PCR product was necessary for discrimination between dermatophyte species (Gutzmer et al. 2006). Some other genes such as chitin synthase I gene (CHS1) or DNA topoisomerase II gene (TOP2) have also been used as a target for species identification of dermatophytes (Kano et al. 1999; Kanbe et al. 2003).

## 17.15 Conclusion and Perspectives

Phenotype-based mycological diagnosis relying upon conventional microbiology and histopathology is time consuming, labor intensive, and often does not warrant sufficient sensitivity and specificity. Phenotype-based identification intrinsically suffers from the variable nature of phenotypic characteristics, which are influenced by culture conditions and subjective interpretation. These issues pose the need, among clinical mycologists, for faster, easier, and more proficient diagnostic tools for fungal infections. DNA-based methods have largely satisfied these needs because of their objective nature, rapidity, broad range of detection (panfungal tests), applicability to a variety of specimen types, capability to provide results that are unaffected by growth conditions, and high discriminatory power, thereby ensuring identification of fungi that would be indistinguishable according to phenotypic traits.

Our review of the current literature on DNA-based methods for fungal identification has highlighted the utility of such methods in clinical practice. In many instances, the simple PCR and sequencing of conserved regions of the fungal genome provides species-level identification with reasonable confidence for both molds and yeasts, including those species which escape identification by conventional techniques or commercially available kits. Furthermore, molecular assays are becoming the only suitable diagnostic approach to early detection of fungal cells (i.e., of their DNA) at low infecting concentrations and in the absence of serological evidence, as in case of immunocompromised patients (White et al. 2006; Badiee et al. 2009). Early diagnosis will allow clinicians to combat fungal infection at an

early stage through choice-specific and effective treatment, avoiding empirical therapy and development of resistance to antimycotic drugs. In this scenario, it is expected that ongoing progress in molecular biology will continue to have a positive impact on medical mycology.

There are many issues, however, that need to be addressed in the future. First, the direct identification of fungal DNA extracted from pathological samples still poses some problem, and most molecular identification methods require preliminary isolation fungi as pure cultures. Second, the percentage of sequence homology required to define fungal species or genera should be clearly established by the scientific community for the main phylogenetic markers, e.g., the rRNA genes. Third, interrogation of public databases of rRNA genes can provide dubious identities because of the presence of uncontrolled entries. If fungal cultures are unavailable, uncertain, or spurious, DNA-based identifications cannot be verified through appropriate phenotypic testing, and the molecular epidemiology of infectious fungi will be difficult to trace. Fourth, the reliability of the current DNA-based identification assays ought to be assessed in the coming years with well-designed prospective studies and regular quality controls. Rigorous testing of molecular assays for the diagnosis of fungal disease through multicenter proficiency studies and external validation from certifying institutions (e.g., USFDA) will be unavoidable steps. Lastly, the clinical meaning of a positive PCR should be test interpreted in the light of our knowledge of the clearance kinetics of fungal DNA in the infected patient; this would help in distinguishing between colonized individuals and infected patients.

Simplification and/or standardization of methods for DNA extraction and detection are likely to facilitate the introduction of molecular technology to routine clinical laboratories (De Marco et al. 2007). But technical problems still need to be solved, primarily the risk of contamination. Nonetheless, the approach of using primers that target multicopy genes is likely to provide the high degrees of sensitivity that are needed for initial diagnosis of severe fungal infection. Automated DNA extraction, real-time PCR techniques, and the development of controlled sequence databases are likely to improve reliability of the current DNA-based identification assays. The usage of close real-time PCR systems (e.g., Light Cycler *SeptiFast*) in the current diagnostic protocols and the development of repPCR-based methods (e.g., *DiversiLab*) for further routine evaluation are partly overcoming contamination issues. At the same time, these commercial systems provide ready-to-use instruments and reagents that render molecular diagnosis affordable even in non specialized laboratories. New advanced molecular approaches based on mass spectrometry (e.g., MALDI-ToF, Matrix-assisted laser description ionization-time of flight-mass spectrometry) are currently under setting for the rapid detection and identification of fungi in clinical microbiology laboratories. They could open new horizons for the fast and reliable management of fungal infections in high risk patients.

**Acknowledgments** This work was supported by Grants from: Ricerca Corrente, Bambino Gesù Hospital Health Care and Research Institute RC 200702P002153 to L.P.; Ricerca Corrente 2008,

INMI “Lazzaro Spallanzani” to P.V.; ISPESL, Ricerca Finalizzata PMS/40/06 to P.V. We acknowledge with great respect the work of very many researchers that has contributed to improve molecular diagnosis of mycoses, and that for reasons of space we were not able to directly reference here.

## References

- Abdel-Rahman SM (2008) Strain differentiation of dermatophytes. *Mycopathologia* 166:319–333
- Badiee P, Kordbacheh P, Albori A, Malekhoseini SA (2007) Invasive fungal infection in renal transplant recipients demonstrated by panfungal polymerase chain reaction. *Exp Clin Transplant* 5:624–629
- Badiee P, Kordbacheh P, Alborzi A, Malekhoseini S, Ramzi M, Mirhendi H, Mahmoodi M, Shakiba E (2009) Study on invasive fungal infections in immunocompromised patients to present a suitable early diagnostic procedure. *Int J Infect Dis* 13:97–102
- Bartie KL, Williams DW, Wilson MJ, Potts AJ, Lewis MA (2001) PCR fingerprinting of *Candida albicans* associated with chronic hyperplastic candidosis and other oral conditions. *J Clin Microbiol* 39:4066–4075
- Basková L, Landlinger C, Preuner S, Lion T (2007) The Pan-AC assay: a single-reaction real-time PCR test for quantitative detection of a broad range of *Aspergillus* and *Candida* species. *J Med Microbiol* 56:1167–1173
- Beretta S, Fulgencio JP, Enache-Angoulvant A, Bernard C, El Metaoua S, Ancelle T, Denis M, Hennequin C (2006) Application of microsatellite typing for the investigation of a cluster of cases of *Candida albicans* candidaemia. *Clin Microbiol Infect* 12:674–676
- Bergman A, Fernandez V, Holmström KO, Claesson BE, Enroth H (2007) Rapid identification of pathogenic yeast isolates by real-time PCR and two-dimensional melting-point analysis. *Eur J Clin Microbiol Infect Dis* 26:813–818
- Bialek R, Fischer J, Feucht A, Najvar LK, Dietz K, Knobloch J, Graybill JR (2001) Diagnosis and monitoring of murine histoplasmosis by a nested PCR assay. *J Clin Microbiol* 39:1506–1509
- Bialek R, Feucht A, Aepinus C, Just-Nübling G, Robertson VJ, Knobloch J, Hohle R (2002a) Evaluation of two nested PCR assays for detection of *Histoplasma capsulatum* DNA in human tissue. *J Clin Microbiol* 40:1644–1647
- Bialek R, Weiss M, Bekure-Nemariam K, Najvar LK, Alberdi MB, Graybill JR, Reischl U (2002b) Detection of *Cryptococcus neoformans* DNA in tissue samples by nested and real-time PCR assays. *Clin Diagn Lab Immunol* 9:461–469
- Bialek R, Cirera AC, Herrmann T, Aepinus C, Shearn-Bochsler VI, Legendre AM (2003) Nested PCR assays for detection of *Blastomyces dermatitidis* DNA in paraffin-embedded canine tissue. *J Clin Microbiol* 41:205–208
- Bialek R, Kern J, Herrmann T, Tijerina R, Cecenas L, Reischl U, Gonzalez GM (2004) PCR assays for identification of *Coccidioides posadasii* based on the nucleotide sequence of the antigen2/proline-rich antigen. *J Clin Microbiol* 42:778–783
- Bialek R, González GM, Begerow D, Zelck UE (2005a) Coccidioidomycosis and blastomycosis: advances in molecular diagnosis. *FEMS Immunol Med Microbiol* 45:355–360
- Bialek R, Konrad F, Kern J, Aepinus C, Cecenas L, Gonzalez GM, Just-Nübling G, Willinger B, Presterl E, Lass-Flörl C, Rickerts V (2005b) PCR based identification and discrimination of agents of mucormycosis and aspergillosis in paraffin wax embedded tissue. *J Clin Pathol* 58:1180–1184
- Bille J, Marchetti O, Calandra T (2005) Changing face of health-care associated fungal infections. *Curr Opin Infect Dis* 18:314–319

- Binnicker MJ, Buckwalter SP, Eisberner JJ, Stewart RA, McCullough AE, Wohlfiel SL, Wengenack NL (2007) Detection of *Coccidioides* species in clinical specimens by real-time PCR. *J Clin Microbiol* 45:173–178
- Birch PRJ, Sims PFG, Broda P (1992) Nucleotide sequence of a gene from *Phanerochaete chrysosporium* that shows homology to the *facA* gene of *Aspergillus nidulans*. *DNA Sequence* 2:319–323
- Bishop JA, Chase N, Lee R, Kurtzman CP, Merz WG (2008) Production of white colonies on CHROMagar *Candida* medium by members of the *Candida glabrata* clade and other species with overlapping phenotypic traits. *J Clin Microbiol* 46:3498–3500
- Blair JE, Logan JL (2001) Coccidioidomycosis in solid organ transplantation. *Clin Infect Dis* 33:1536–1544
- Blanz P, Buzina W, Ginter G, Gräser Y (2000) Molecular biological methods in taxonomy and diagnostics of dermatophytes. *Mycoses* 43:11–16
- Blumberg HM, Jarvis WR, Soucie JM, Edwards JE, Patterson JE, Pfaller MA, Rangel-Frausto MS, Rinaldi MG, Saiman L, Wiblin RT, Wenzel RP, The NEMIS Study Group (2001) Risk factors for candidal bloodstream infections in surgical intensive care unit patients: the NEMIS prospective multicenter study. *Clin Infect Dis* 33:177–186
- Bougnoux ME, Dupont C, Mateo J, Saulnier P, Faivre V, Payen D, Nicolas-Chanoine MH (1999) Serum is more suitable than whole blood for diagnosis of systemic candidiasis by nested PCR. *J Clin Microbiol* 37:925–930
- Boutati EI, Anaissie EJ (1997) *Fusarium*, a significant emerging pathogen in patients with hematologic malignancy: ten years' experience at a cancer center and implications for management. *Blood* 90:999–1008
- Bowen AR, Chen-Wu JL, Momany M, Young R, Szaniszlo PJ, Robbins PW (1992) Classification on fungal chitin synthases. *Proc Natl Acad Sci USA* 89:519–523
- Boyanton BL Jr, Luna RA, Fasciano LR, Menne KG, Versalovic J (2008) DNA pyrosequencing-based identification of pathogenic *Candida* species by using the internal transcribed spacer 2 region. *Arch Pathol Lab Med* 132:667–674
- Bracca A, Tosello ME, Girardini JE, Amigot SL, Gomez C, Serra E (2003) Molecular detection of *Histoplasma capsulatum* var *capsulatum* in human clinical samples. *J Clin Microbiol* 41:1753–1755
- Bretagne S (2003) Molecular diagnostics in clinical parasitology and mycology: limits of the current polymerase chain reaction (PCR) assays and interest of the real-time PCR assays. *Clin Microbiol Infect* 9:505–511
- Bretagne S, Costa JM (2005) Towards a molecular diagnosis of invasive aspergillosis and disseminated candidosis. *FEMS Immunol Med Microbiol* 45:361–368
- Bretagne S, Costa JM, Marmorat-Khuong A, Poron F, Cordonnier C, Vidaud M, Fleury-Feith J (1995) Detection of *Aspergillus* species DNA in bronchoalveolar lavage samples by competitive PCR. *J Clin Microbiol* 33:1164–1168
- Bretagne S, Costa JM, Bart-Delabesse E, Dhédin N, Rieux C, Cordonnier C (1998) Comparison of serum galactomannan antigen detection and competitive polymerase chain reaction for diagnosing invasive aspergillosis. *Clin Infect Dis* 26:1407–1412
- Bruns TD, Vilgalys R, Barns SM, Gonzalez D, Hibbett DS, Lane DJ, Simon L, Stickel S, Szaro TM, Weisburg WG, Sogin ML (1992) Evolutionary relationships within the fungi: analyses of small subunit ribosomal DNA sequences. *Appl Environ Microbiol* 61:681–689
- Buchheidt D, Hummel M (2005) *Aspergillus* polymerase chain reaction (PCR) diagnosis. *Med Mycol* 43:S139–S145
- Buchman TG, Rossier M, Mertz WG, Charache P (1990) Detection of surgical pathogens by in vitro DNA amplification Part I Rapid identification of *Candida albicans* by in vitro amplification of a fungus specific gene. *Surgery* 108:338–347
- Bulloke WE (1995) *Histoplasma capsulatum*. In: Mandell GL, Bennet J, Dolin R (eds) Principles and practice of infectious diseases, vol 1. Elsevier Churchill Livingstone, New York, NY, pp 2340–2353



- Burgener-Kairuz P, Zuber JP, Jaunin P, Buchman TG, Bille J, Rossier MJ (1994) Rapid detection and identification of *Candida albicans* and *Torulopsis (Candida) glabrata* in clinical specimens by species-specific nested PCR amplification of a cytochrome P-450 lanosterol-alpha-demethylase (L1A1) gene fragment. *Clin Microbiol* 32:1902–1907
- Burnie JP, Golband N, Matthews RC (1997) Semiquantitative polymerase chain reaction enzyme immunoassay for diagnosis of disseminated candidiasis. *Eur J Clin Microbiol Infect Dis* 16:346–350
- Cairns L, Blythe D, Kao A, Pappagianis D, Kaufman L, Kobayashi J, Hajjeh R (2000) Outbreak of coccidioidomycosis in Washington State residents returning from Mexico. *Clin Infect Dis* 30:61–64
- Chagas-Neto TC, Chaves GM, Colombo AL (2008) Update on the genus *Trichosporon*. *Mycopathologia* 166:121–132
- Challier S, Boyer S, Abachin E, Berche P (2004) Development of a serum-based Taqman real-time PCR assay for diagnosis of invasive aspergillosis. *J Clin Microbiol* 42:844–846
- Chang HC, Leaw SN, Huang AH, Wu TL, Chang TC (2001) Rapid identification of yeasts in positive blood cultures by a multiplex PCR method. *J Clin Microbiol* 39:3466–3471
- Chang DC, Anderson S, Wannemuehler K, Engelthaler DM, Erhart L, Sunenshine RH, Burwell LA, Park BJ (2008) Testing for coccidioidomycosis among patients with community-acquired pneumonia. *Emerg Infect Dis* 14:1053–1059
- Chayakulkeeree M, Ghannoum MA, Perfect JR (2006) Zygomycosis: the re-emerging fungal infection. *Eur J Clin Microbiol Infect Dis* 25:215–229
- Chen SC, Halliday CL, Meyer W (2002) A review of nucleic acid-based diagnosis tests for systemic mycoses with an emphasis on polymerase chain reaction-based assays. *Med Mycol* 40:333–357
- Chen SC, Tong ZS, Lee OC, Halliday C, Playford EG, Widmer F, Kong FR, Wu C, Sorrell TC (2008) Clinician response to *Candida* organisms in the urine of patients attending hospital. *Eur J Clin Microbiol Infect Dis* 27:201–208
- Chiller TM, Galgiani JN, Stevens DA (2003) Coccidioidomycosis. *Infect Dis Clin North Am* 17:41–57
- Chowdhary A, Guarro J, Randhawa HS, Gené J, Cano J, Jain RK, Kumar S, Khanna G (2008) A rare case of chromoblastomycosis in a renal transplant recipient caused by a non-sporulating species of *Rhizoglyphus*. *Med Mycol* 46:163–166
- Chryssanthou E, Andersson B, Petrini B, Lofdahl S, Tollemar J (1994) Detection of *Candida albicans* DNA in serum by polymerase chain reaction. *Scand J Infect Dis* 26:479–485
- Cornely OA (2008) *Aspergillus* to Zygomycetes: causes, risk factors, prevention, and treatment of invasive fungal infections. *Infection* 36:296–313
- Costa C, Vidaud D, Olivi M, Bart-Delabesse E, Vidaud M, Bretagne S (2001) Development of two real-time quantitative TaqMan PCR assays to detect circulating *Aspergillus fumigatus* DNA in serum. *J Microbiol Methods* 44:263–269
- Costa C, Costa JM, Desterke C, Botterel F, Cordonnier C, Bretagne S (2002) Real-time PCR coupled with automated DNA extraction and detection of galactomannan antigen in serum by enzyme-linked immunosorbent assay for diagnosis of invasive aspergillosis. *J Clin Microbiol* 40:2224–2227
- Cox GM, Rude TH, Dykstra CC, Perfect JR (1995) The actin gene from *Cryptococcus neoformans*: structure and phylogenetic analysis. *J Med Vet Mycol* 33:261–266
- Crampin AC, Matthews RC (1993) Application of the polymerase chain reaction to the diagnosis of candidosis by amplification of an HSP 90 gene fragment. *J Med Microbiol* 39:233–238
- Cuenca-Estrella M, Meije Y, Diaz-Pedroche C, Gomez-Lopez A, Buitrago MJ, Bernal-Martinez L, Grande C, Juan RS, Lizasoain M, Rodriguez-Tudela JL, Aguado JM (2009) Value of serial quantification of fungal DNA by a real-time PCR-based technique for early diagnosis of invasive Aspergillosis in patients with febrile neutropenia. *J Clin Microbiol* 47:379–384
- D'Antonio D, Violante B, Mazzoni A, Bonfini T, Capuani MA, D'Aloia F, Lacone A, Schioppa F, Romano F (1998) A nosocomial cluster of *Candida inconspicua* infections in patients with haematological malignancies. *J Clin Microbiol* 36:792–795

- Dalle F, Lopez J, Caillot D, Cuisenier B, Ecartot LA, Dumont L, Bonnin A (2002) False-positive results caused by cotton swabs in commercial *Aspergillus* antigen latex agglutination test. *Eur J Clin Microbiol Infect Dis* 21:130–132
- Davidson FD, Mackenzie DWR, Owen RJ (1980) Deoxyribonucleic acid base compositions of dermatophytes. *J Gen Microbiol* 118:465–470
- de Aguirre L, Hurst SF, Choi JS, Shin JH, Hinrikson HP, Morrison CJ (2004) Rapid differentiation of *Aspergillus* species from other medically important opportunistic molds and yeasts by PCR-enzyme immunoassay. *J Clin Microbiol* 42:3495–3504
- de Hoog GS, Gerrits van den Ende AHG (1992) Nutritional pattern and eco-physiology of *Hortaea werneckii*, agent of human tinea nigra. *Antonie Van Leeuwenhoek Int J G* 62:321–329
- de Hoog GS, Gerrits van den Ende AHG (1998) Molecular diagnostics of clinical strains of filamentous Basidiomycetes. *Mycoses* 41:183–189
- De Marco D, Perotti M, Ossi CM, Burioni R, Clementi M, Mancini N (2007) Development and validation of a molecular method for the diagnosis of medically important fungal infections. *New Microbiol* 30:308–312
- Diekema DJ, Pfaller MA (2004) Nosocomial candidemia: an ounce of prevention is better than a pound of cure. *Infect Control Hosp Epidemiol* 25:624–626
- Dunyach C, Bertout S, Phelipeau C, Drakulovski P, Reynes J, Mallié M (2008) Diagn Detection and identification of *Candida* spp in human serum by Light Cycler real-time polymerase chain reaction. *Microbiol Infect Dis* 60:263–271
- Edwards JE (1991) Invasive *Candida* infections. *N Engl J Med* 324:1060–1062
- Eggimann P, Francioli P, Bille J, Schneider R, Wu M-W, Chapuis G, Chiolerio R, Pannatier A, Schilling J, Geroulanos S, Glauser MP, Calandra T (1999) Fluconazole prophylaxis prevents intraabdominal candidiasis in high-risk surgical patients. *Crit Care Med* 27:1066–1072
- Einsele H, Hebart H, Roller G, Löffler J, Rothenhofer I, Muller CA, Bowden RA, van Burik J, Engelhard D, Kanz L, Schumacher U (1997) Detection and identification of fungal pathogens in blood by using molecular probes. *J Clin Microbiol* 35:1353–1360
- Elie CM, Lott TJ, Reiss E, Morrison CJ (1998) Rapid identification of *Candida* species with species-specific probes. *J Clin Microbiol* 36:3260–3265
- Ersoz G, Otag F, Erturan Z, Aslan G, Kaya A, Emekdas G, Sugita T (2004) An outbreak of *Dipodascus capitatus* infection in the ICU: three case reports and review of the literature. *Jpn J Infect Dis* 57:248–252
- Evertsson U, Monstein HJ, Johansson AG (2000) Detection and identification of fungi in blood using broad-range 28S rRNA PCR amplification and species-specific hybridisation. *APMIS* 108:385–392
- Faber J, Moritz N, Henninger N, Zepp F, Knuf M (2009) Rapid detection of common pathogenic *Aspergillus* species by a novel real-time PCR approach. *Mycoses* 52:228–233
- Farr RC, Gardner G, Acker JD, Brint JM, Haglund LF, Land M, Schweitzer JB, West BC (1992) Blastomycotic cranial osteomyelitis. *Am J Otol* 13:582–586
- Fisher MC, Koenig GL, White TJ, San-Blas G, Negrone R, Alvarez IG, Wanke B, Taylor JW (2001) Biogeographic range expansion into South America by *Coccidioides immitis* mirrors New World patterns of human migration. *Proc Natl Acad Sci U S A* 98:4558–62
- Fisher MC, Koenig GL, White TJ, Taylor JW (2002) Molecular and phenotypic description of *Coccidioides posadasii* sp nov, previously recognized as the non-California population of *Coccidioides immitis*. *Mycologia* 94:73–84
- Franzot SP, Salkin IF, Casadevall A (1999) *Cryptococcus neoformans* var grubii: separate varietal status for *Cryptococcus neoformans* serotype A isolates. *J Clin Microbiol* 37:838–840
- Frater JL, Hall GS, Procop GW (2001) Histologic features of zygomycosis: emphasis on perineural invasion and fungal morphology. *Arch Pathol Lab Med* 125:375–378
- Fredricks DN, Smith C, Meier AJ (2005) Comparison of six DNA extraction methods for recovery of fungal DNA as assessed by quantitative PCR. *Clin Microbiol* 43:5122–5128
- Freifeld AG, Iwen PC, Lesiak BL, Gilroy RK, Stevens RB, Kalil AC (2005) Histoplasmosis in solid organ transplant recipients at a large Midwestern university transplant center. *Transpl Infect Dis* 7:109–115

- Friedman GD, Jeffrey Fessel W, Udaltsova NV, Hurley LB (2005) Cryptococcosis: the 1981–2000 epidemic. *Mycoses* 48:122–125
- Galgiani JN (1992) Coccidioidomycosis: changes in clinical expression, serological diagnosis, and therapeutic options. *Clin Infect Dis* 14:S100–S105
- Galgiani JN (1999) Coccidioidomycosis: a regional disease of national importance – rethinking approaches for control. *Ann Intern Med* 130:293–300
- Geha DJ, Roberts GD (1994) Laboratory detection of fungemia. *Clin Lab Med* 14:83–97
- Girmeria C, Martino P, De Bernardis F, Cassone A (1997) Assessment of detection of *Candida* mannoproteinemia as a method to differentiate central venous catheter-related candidemia from invasive disease. *J Clin Microbiol* 35:903–906
- Girmeria C, Pagano L, Martino B, D'Antonio D, Fanci R, Specchia G, Melillo L, Buelli M, Pizzarelli G, Venditti M, Martino P, Infection Program GIMEMA (2005) Invasive infections caused by *Trichosporon* species and *Geotrichum capitatum* in patients with hematological malignancies: a retrospective multicenter study from Italy and review of the literature. *J Clin Microbiol* 43:1818–1828
- Gomez BL, Figueroa JI, Hamilton AJ, Ortiz BL, Robledo MA, Restrepo A, Hay RJ (1997) Development of a novel antigen detection test for histoplasmosis. *J Clin Microbiol* 35:2618–2622
- Gonzalez CE, Rinaldi MG, Sugar AM (2002) Zygomycosis. *Infect Dis Clin North Am* 16:895–914
- Gräser Y, Kuijpers AFA, Presber W, de Hoog GS (2000) Molecular taxonomy of the *Trichophyton rubrum* complex. *J Clin Microbiol* 38:3329–3336
- Griffin DW, Kellogg CA, Peak KK, Shinn EA (2002) A rapid and efficient assay for extracting DNA from fungi. *Lett Appl Microbiol* 34:210–214
- Griffiths LJ, Anyim M, Doffman SR, Wilks M, Millar MR, Agrawal SG (2006) Comparison of DNA extraction methods for *Aspergillus fumigatus* using real-time PCR. *J Med Microbiol* 55:1187–1191
- Grigis A, Farina C, Symoens F, Nolard N, Goglio A (2000) Nosocomial pseudo-outbreak of *Fusarium verticillioides* associated with sterile plastic containers. *Infect Control Hosp Epidemiol* 21:50–52
- Gromadzki SG, Chaturvedi V (2000) Limitation of the AccuProbe *Coccidioides immitis* culture identification test: falsenegative results with formaldehyde-killed cultures. *J Clin Microbiol* 38:2427–2428
- Guarro J, Gené J, Stchigel AM (1999) Developments in fungal taxonomy. *Clin Microbiol Rev* 12:454–500
- Guedes HL, Guimarães AJ, Muniz Mde M, Pizzini CV, Hamilton AJ, Peralta JM, Deepe GS Jr, Zancopé-Oliveira RM (2003) PCR assay for identification of *Histoplasma capsulatum* based on the nucleotide sequence of the M antigen. *J Clin Microbiol* 41:535–539
- Guého E, Improvisi L, Christen R, de Hoog GS (1993) Phylogenetic relationships of *Cryptococcus neoformans* and some related basidiomycetous yeasts determined from partial large subunit rRNA sequences. *Antonie Van Leeuwenhoek Int J Genet* 63:175–189
- Guiver M, Levi K, Oppenheim BA (2001) Rapid identification of *Candida* species by TaqMan PCR. *J Clin Pathol* 54:362–366
- Gupta AK, Boekhout T, Theelen B, Summerbell R, Batra R (2004) Identification and typing of *Malassezia* species by amplified fragment length polymorphism and sequence analyses of the internal transcribed spacer and large-subunit regions of ribosomal DNA. *J Clin Microbiol* 42:4253–4260
- Gutzmer R, Mommert S, Küttler U, Werfel T, Kapp A (2006) Rapid identification and differentiation of fungal DNA in dermatological specimens by LightCycler PCR. *J Med Microbiol* 53:1207–1214
- Hall L, Wohlfiel S, Roberts GD (2003) Experience with the MicroSeq D2 large-subunit ribosomal DNA sequencing kit for identification of commonly encountered, clinically important yeast species. *J Clin Microbiol* 41:5099–5102
- Hall L, Wohlfiel S, Roberts GD (2004) Experience with the MicroSeq D2 large-subunit ribosomal DNA sequencing kit for identification of filamentous fungi encountered in the clinical laboratory. *J Clin Microbiol* 42:622–626

- Halliday C, Wu QX, James G, Sorrell T (2005) Development of a nested qualitative real-time PCR assay to detect *Aspergillus* species DNA in clinical specimens. *J Clin Microbiol* 43:5366–5368
- Hamilton JR, Noble A, Denning DW, Stevens DA (1991) Performance of cryptococcus antigen latex agglutination kits on serum and cerebrospinal fluid specimens of AIDS patients before and after pronase treatment. *J Clin Microbiol* 29:333–339
- Hansen D, Healy M, Reece K, Smith C, Woods GL (2008) Repetitive-sequence-based PCR using the DiversiLab system for identification of *Aspergillus* species. *J Clin Microbiol* 46:1835–1839
- Harmesen MC, Schuren FHJ, Moukha SM, van Zuilen CM, Punt PJ, Wessels JGH (1992) Sequence analysis of the glyceraldehyde-3-phosphate dehydrogenase genes from the basidiomycetes *Schizophyllum commune*, *Phanerochaete chrysosporium* and *Agaricus bisporus*. *Curr Genet* 22:447–454
- Hashiguchi K, Niki Y, Soejima R (1994) Cyclophosphamide induces false positive results in detection of *Aspergillus* antigen in urine. *Chest* 105:975–976
- Hassouna N, Michot B, Bachelletre J (1984) The complete nucleotide sequence of mouse 28S rRNA gene Implications for the process of size increase of the large subunit rRNA in higher eukaryotes. *Nucleic Acids Res* 8:3563–3583
- Hata DJ, Buckwalter SP, Pritt BS, Roberts GD, Wengenack NL (2008) Real-time PCR method for detection of zygomycetes. *J Clin Microbiol* 46:2353–2358
- Hay RJ (1995) Dermaphytophytosis and other superficial mycoses. In: Mandell GL, Bennet J, Dolin R (eds) Principles and practice of infectious diseases, vol 1. Elsevier Churchill Livingstone, New York, NY, pp 3051–3062
- Hayden RT, Qian X, Roberts GD, Lloyd RV (2001) In situ hybridization for the identification of yeastlike organisms in tissue section. *Diagn Mol Pathol* 10:15–23
- Hazen KC (1995) New and emerging yeast pathogens. *Clin Microbiol Rev* 8:462–478
- Hazen KC (1996) Methods for fungal identification in the clinical mycology laboratory. *Clin Microbiol News* 18:137–144
- Healy M, Reece K, Walton D, Huang J, Shah K, Kontoyiannis DP (2004) Identification to the species level and differentiation between strains of *Aspergillus* clinical isolates by automated repetitive-sequence-based PCR. *J Clin Microbiol* 42:4016–4024
- Hendolin PH, Paulin L, Koukila-Kähkölä P, Anttila VJ, Malmberg H, Richardson M, Ylikoski J (2000) Panfungal PCR and multiplex liquid hybridization for detection of fungi in tissue specimens. *J Clin Microbiol* 38:4186–4192
- Henry T, Iwen PC, Hinrichs SH (2000) Identification of *Aspergillus* species using internal transcribed spacer regions 1 and 2. *J Clin Microbiol* 38:1510–1515
- Hibbett DS (1992) Ribosomal RNA and fungal systematics. *Trans Mycol Soc Jpn* 33:533–556
- Hibbett DS, Binder M, Bischoff JF, Blackwell M, Cannon PF, Eriksson OE, Huhndorf S, James T, Kirk PM, Lücking R, Thorsten Lumbsch H, Lutzoni F, Matheny PB, McLaughlin DJ, Powell MJ, Redhead S, Schoch CL, Spatafora JW, Stalpers JA, Vilgalys R, Aime MC, Aptroot A, Bauer R, Begerow D, Benny GL, Castlebury LA, Crous PW, Dai YC, Gams W, Geiser DM, Griffith GW, Gueidan C, Hawksworth DL, Hestmark G, Hosaka K, Humber RA, Hyde KD, Ironside JE, Kõljalg U, Kurtzman CP, Larsson KH, Lichtwardt R, Longcore J, Miadlikowska J, Miller A, Moncalvo JM, Mozley-Standridge S, Oberwinkler F, Parmasto E, Reeb V, Rogers JD, Roux C, Ryvarden L, Sampaio JP, Schüssler A, Sugiyama J, Thorn RG, Tibell L, Untereiner WA, Walker C, Wang Z, Weir A, Weiss M, White MM, Winka K, Yao YJ, Zhang N (2007) A higher-level phylogenetic classification of the fungi. *Mycol Res* 111:509–547
- Hinrikson HP, Hurst SF, Lott TJ, Warnock DW, Morrison CJ (2005) Assessment of ribosomal large-subunit D1–D2, internal transcribed spacer 1, and internal transcribed spacer 2 regions as targets for molecular identification of medically important *Aspergillus* species. *J Clin Microbiol* 43:2092–2103
- Hockey LJ, Fujita NK, Gibson TR, Rotrosen D, Montgomerie JZ, Edwards JE Jr (1982) Detection of fungemia obscured by concomitant bacteremia: *in vitro* and *in vivo* studies. *J Clin Microbiol* 16:1080–1085

- Hope WW, Walsh TJ, Denning DW (2005) Laboratory diagnosis of invasive aspergillosis. *Lancet Infect Dis* 5:609–622
- Hopfer RL, Walden P, Setterquist S, Highsmith WE (1993) Detection and differentiation of fungi in clinical specimens using polymerase chain reaction (PCR) amplification and restriction enzyme analysis. *J Med Vet Mycol* 31:65–75
- Hospenthal DR (1995) Agents of chromoblastomycosis. In: Mandell GL, Bennet J, Dolin R (eds) *Principles and practice of infectious diseases*, vol 1. Elsevier Churchill Livingstone, New York, NY, pp 2988–2991
- Hull CM, Heitman J (2002) Genetics of *Cryptococcus neoformans*. *Annu Rev Genet* 36:557–615
- Inácio J, Flores O, Spencer-Martins I (2008) Efficient identification of clinically relevant *Candida* yeast species by use of an assay combining panfungal loop-mediated isothermal DNA amplification with hybridization to species-specific oligonucleotide probes. *J Clin Microbiol* 46:713–720
- Innings A, Ullberg M, Johansson A, Rubin CJ, Noreus N, Isaksson M, Herrmann B (2007) Multiplex real-time PCR targeting the RNase P RNA gene for detection and identification of *Candida* species in blood. *J Clin Microbiol* 45:874–880
- Ito-Kuwa S, Nakamura K, Aoki S, Vidotto V (2007) Serotype identification of *Cryptococcus neoformans* by multiplex PCR. *Mycoses* 50:277–281
- Iwen PC (2003) Molecular detection and typing of fungal pathogens. *Clin Lab Med* 23:781–799
- Iwen PC, Freifeld AG, Bruening TA, Hinrichs SH (2004) Use of a panfungal PCR assay for detection of fungal pathogens in a commercial blood culture system. *J Clin Microbiol* 42:2292–2293
- Iyer RS, Banker DD (2002) Cryptococcal meningitis in AIDS. *Indian J Med Sci* 56:593–597
- Jackson CJ, Barton RC, Evance EGV (1999) Species identification and strain differentiation of dermatophyte fungi by analysis of ribosomal-DNA intergenic spacer regions. *J Clin Microbiol* 37:931–936
- Jordan JA (1994) PCR identification of four medically important *Candida* species by using a single primer pair. *J Clin Microbiol* 32:2962–2967
- Kac G (2000) Molecular approaches to the study of dermatophytes. *Med Mycol* 38:329–336
- Kami M, Fukui T, Ogawa S, Kazuyama Y, Machida U, Tanaka Y, Kanda Y, Kashima T, Yamazaki Y, Hamaki T, Mori S, Akiyama H, Mutou Y, Sakamaki H, Osumi K, Rimura S, Hirai H (2001) Use of real-time PCR on blood samples for diagnosis of invasive aspergillosis. *Clin Infect Dis* 33:1504–1512
- Kan VL (1993) Polymerase chain reaction for the diagnosis of candidemia. *J Infect Dis* 168:779–783
- Kanbe T (2008) Molecular approaches in the diagnosis of dermatophytosis. *Mycopathologia* 166:307–317
- Kanbe T, Suzuki Y, Kamiya A, Mochizuki T, Fujihira M, Kikuchi A (2003) PCR-based identification of common dermatophyte species using primer sets specific for the DNA topoisomerase II genes. *J Dermatol Sci* 32:151–161
- Kano R, Nakamura Y, Watari T, Watanabe S, Takahashi H, Tsujimoto H, Hasegawa A (1999) Species-specific primers of chitin synthase 1 gene for the differentiation of the *Trichophyton mentagrophytes* complex. *Mycoses* 42:71–74
- Kano R, Fujino Y, Takamoto N, Tsujimoto H, Hasegawa A (2001) PCR detection of the *Cryptococcus neoformans* CAPS9 gene from a biopsy specimen from a case of feline cryptococcosis. *J Vet Diagn Invest* 13:439–442
- Kantarcioglu AS, de Hoog GS (2004) Infections of the central nervous system by melanized fungi: a review of cases presented between 1999 and 2004. *Mycoses* 47:4–13
- Kappe R, Rimek D (1999) Laboratory diagnosis of *Aspergillus fumigatus*-associated diseases. *Contrib Microbiol* 2:88–104
- Kappe R, Schulze-Berge A (1993) New cause for false-positive results with the Pastorex *Aspergillus* antigen latex agglutination test. *J Clin Microbiol* 31:2489–2490
- Karabinis A, Hill C, Leclercq B, Tancrede C, Baume D, Andreumont A (1988) Risk factors for candidemia in cancer patients: a case-control study. *J Clin Microbiol* 26:429–432

- Kasai M, Harrington SM, Francesconi A, Petraitis V, Petraitiene R, Beveridge MG, Knudsen T, Milanovich J, Cotton MP, Hughes J, Schaufele RL, Sein T, Bacher J, Murray PR, Kontoyiannis DP, Walsh TJ (2008) Detection of a Molecular Biomarker for Zygomycetes by Quantitative PCR Assays in Plasma, Bronchoalveolar Lavage, and Lung Tissue in Pulmonary Zygomycosis. *J Clin Microbiol* 46:3690–3702
- Kauffman CA (2006) Endemic mycoses: blastomycosis, histoplasmosis, and sporotrichosis. *Infect Dis Clin North Am* 20:645–662
- Kaufman L, Valero G, Padhye AA (1998) Misleading manifestations of *Coccidioides immitis* in vivo. *J Clin Microbiol* 36:3721–3723
- Kendrick B (1992) The fifth kingdom, 2nd edn. Mycologue Publications, Waterloo, Canada
- Kiska DL, Orkiszewski DR, Howell D, Gilligan PH (1994) Evaluation of new monoclonal antibody-based latex agglutination test for detection of cryptococcal polysaccharide antigen in serum and cerebrospinal fluid. *J Clin Microbiol* 32:2309–2311
- Klingspor L, Jalal S (2006) Molecular detection and identification of *Candida* and *Aspergillus* spp from clinical samples using real-time PCR. *Clin Microbiol Infect* 12:745–753
- Klingspor L, Loeffler J (2009) *Aspergillus* PCR formidable challenges and progress. *Med Mycol* 47:S241–247
- Kobayashi M, Togitani K, Machida H, Uemura Y, Ohtsuki Y, Taguchi H (2004) Molecular polymerase chain reaction diagnosis of pulmonary mucormycosis caused by *Cunninghamella bertholletiae*. *Respirology* 9:397–401
- Kontoyiannis DP, Bodey GP (2002) Invasive aspergillosis in 2002: an update. *Eur J Clin Microbiol Infect Dis* 21:161–172
- Kontoyiannis DP, Wessel VC, Bodey GP, Rolston KV (2000) Zygomycosis in the 1990s in a tertiary-care cancer center. *Clin Infect Dis* 30:851–856
- Kontoyiannis DP, Lionakis MS, Lewis RE, Chamilos G, Healy M, Perego C, Safdar A, Kantarjian H, Champlin R, Walsh TJ, Raad II (2005) Zygomycosis in a tertiary-care cancer center in the era of *Aspergillus*-active antifungal therapy: a case-control observational study of 27 recent cases. *J Infect Dis* 191:1350–1360
- Kurtzman CP, Fell JW (1998) The yeasts, a taxonomic study, 4th edn. Elsevier Science BV, Amsterdam, pp 90–1000
- Kurtzman CP, Robnett CJ (1991) Phylogenetic relationships among species of *Saccharomyces*, *Schizosaccharomyces*, *Debaryomyces*, and *Schwanniomyces* determined from partial ribosomal RNA sequences. *Yeast* 7:61–72
- Kurtzman CP, Robnett CJ (1994) Synonymy of the yeast genera *Wingea* and *Debaryomyces*. *Antonie Van Leeuwenhoek* 66:337–342
- Kurtzman CP, Robnett CJ (1998) Identification and phylogeny of ascomycetous yeasts from analysis of nuclear large subunit (26S) ribosomal DNA partial sequences. *Antonie Van Leeuwenhoek* 73:331–371
- Kwon-Chung KJ, Boekhout T, Fell JW (2002) Proposal to conserve the name *Cryptococcus gattii* against *C hondurianus* and *C bacillisporus*. *Taxon* 51:804–806
- Latgé JP (1999) *Aspergillus fumigatus* and aspergillosis. *Clin Microbiol Rev* 12:310–350
- Latgé JP, Kobayashi H, Debeaupuis JP, Diaquin M, Sarfati J, Wieruszkeski JM, Parra E, Bouchara JP, Fournet B (1994) Chemical and immunological characterization of the extracellular galactomannan of *Aspergillus fumigatus*. *Infect Immun* 62:5424–5433
- Lau A, Chen S, Sorrell T, Carter D, Malik R, Martin P, Halliday C (2007) Development and clinical application of a panfungal PCR assay to detect and identify fungal DNA in tissue specimens. *J Clin Microbiol* 45:380–385
- Lemieux C, St-Germain G, Vincelette J, Kaufman L, de Repentigny L (1990) Collaborative evaluation of antigen detection by a commercial latex agglutination test and enzyme immunoassay in the diagnosis of invasive candidiasis. *J Clin Microbiol* 28:249–253
- Li YL, Leaw SN, Chen JH, Chang HC, Chang TC (2003) Rapid identification of yeasts commonly found in positive blood cultures by amplification of the internal transcribed spacer regions 1 and 2. *Eur J Clin Microbiol Infect Dis* 22:693–696

- Lindsley MD, Hurst SF, Iqbal NJ, Morrison CJ (2001) Rapid identification of dimorphic and yeast-like fungal pathogens using specific DNA probes. *J Clin Microbiol* 39:3505–3511
- Linton CJ, Borman AM, Cheung G, Holmes AD, Szekely A, Palmer MD, Bridge PD, Campbell CK, Johnson EM (2007) Molecular identification of unusual pathogenic yeast isolates by large ribosomal subunit gene sequencing: 2 years of experience at the United Kingdom mycology reference laboratory. *J Clin Microbiol* 45:1152–1158
- Lionakis MS, Kontoyiannis DP (2004) *Fusarium* infections in critically ill patients. *Semin Respir Crit Care Med* 25:159–169
- Liu D, Pearce L, Lilley G, Coloe S, Baird R, Pedersen J (2002) PCR identification of dermatophyte fungi *Trichophyton rubrum*, *T soudanense* and *T gourvilii*. *J Med Microbiol* 51:117–122
- Löffler J, Hebart H, Schumacher U, Reitze H, Einsele H (1997) Comparison of different methods for extraction of DNA of fungal pathogens from cultures and blood. *J Clin Microbiol* 35:3311–3312
- Löffler J, Hebart H, Sepe S, Schumacher U, Klingebiel T, Einsele H (1998) Detection of PCR-amplified fungal DNA by using a PCR-ELISA system. *Med Mycol* 36:275–279
- Löffler J, Hebart H, Bialek R, Hagemeyer L, Schmidt D, Serey FP, Hartmann M, Eucker J, Einsele H (1999) Contaminations occurring in fungal PCR assays. *J Clin Microbiol* 37:1200–1202
- Löffler J, Hebart H, Brauchle U, Schumacher U, Einsele H (2000) Comparison between plasma and whole blood specimens for detection of *Aspergillus* DNA by PCR. *J Clin Microbiol* 38:3830–3833
- Logotheti M, Kotsovoli-Tseleni A, Arsenis G, Legakis NI (2009) Multiplex PCR for the discrimination of *A fumigatus*, *A flavus*, *A niger* and *A terreus*. *J Microbiol Methods* 76:209–211
- Lott TJ, Burns BM, Zancope-Oliveira R, Elie CM, Reiss E (1998) Sequence analysis of the internal transcribed spacer 2 (ITS2) from yeast species within the genus *Candida*. *Curr Microbiol* 36:63–69
- Maaroufi Y, Heymans C, De Bruyne JM, Duchateau V, Rodriguez-Villalobos H, Aoun M, Crokaert F (2003) Rapid detection of *Candida albicans* in clinical blood samples by using a TaqMan-based PCR assay. *J Clin Microbiol* 41:3293–3298
- Machouart M, Larche J, Burton K, Collomb J, Maurer P, Cintrat A, Biava MF, Greciano S, Kuijpers AF, Contet-Audonneau N, de Hoog GS, Gerard A, Fortier B (2006) Genetic identification of the main opportunistic Mucorales by PCR-restriction fragment length polymorphism. *J Clin Microbiol* 44:805–810
- Makimura K, Murayama SY, Yamaguchi H (1994) Specific detection of *Aspergillus* and *Penicillium* species from respiratory specimens by polymerase chain reaction (PCR). *Jpn J Med Sci Biol* 47:141–156
- Makimura K, Tamura Y, Mochizuki T, Hasegawa A, Tajiri Y, Hanazawa R, Uchida K, Saito H, Yamaguchi H (1999) Phylogenetic classification and species identification of dermatophyte strains based on DNA sequences of nuclear ribosomal internal transcribed spacer 1 regions. *J Clin Microbiol* 37:920–924
- Mancini N, Clerici D, Diotti R, Perotti M, Ghidoli N, De Marco D, Pizzorno B, Emrich T, Burioni R, Ciceri F, Clementi M (2008) Molecular diagnosis of sepsis in neutropenic patients with haematological malignancies. *J Med Microbiol* 57:601–604
- Martagon-Villamil J, Shrestha N, Sholtis M, Isada CM, Hall GS, Bryne T, Lodge BA, Reller LB, Procop GW (2003) Identification of *Histoplasma capsulatum* from culture extracts by real-time PCR. *J Clin Microbiol* 41:1295–1298
- Martin C, Roberts D, van Der Weide M, Rossau R, Jannes G, Smith T, Maher M (2000) Development of a PCR-based line probe assay for identification of fungal pathogens. *J Clin Microbiol* 38:3735–3742
- McCullough MJ, DiSalvo AF, Clemons KV, Park P, Stevens DA (2000) Molecular epidemiology of *Blastomyces dermatitidis*. *Clin Infect Dis* 30:328–335
- Medoff G, Dismukes WE, Pappagianis D, Diamond R, Gallis HA, Drutz D (1992) Evaluation of new antifungal drugs for the treatment of systemic fungal infections Infectious Diseases Society of America and the Food and Drug Administration. *Clin Infect Dis* 15:S274–S281

- Mekha N, Sugita T, Ikeda R, Nishikawa A, Poonwan N (2007) Real-time PCR assay to detect DNA in sera for the diagnosis of deep-seated trichosporonosis. *Microbiol Immunol* 51:633–635
- Melcher GP, Reed KD, Rinaldi MG, Lee JW, Pizzo PA, Walsh TJ (1991) Demonstration of a cell wall antigen cross-reacting with cryptococcal polysaccharide in experimental disseminated trichosporonosis. *J Clin Microbiol* 29:192–196
- Melchers WJ, Verweij PE, van den Hurk P, van Belkum A, De Pauw BE, Hoogkamp-Korstanje JA, Meis JF (1994) General primer-mediated PCR for detection of *Aspergillus* species. *J Clin Microbiol* 32:1710–1717
- Mengoli C, Cruciani M, Barnes RA, Loeffler J, Donnelly JP (2009) Use of PCR for diagnosis of invasive aspergillosis: systematic review and meta-analysis. *Lancet Infect Dis* 9:89–96
- Mennink-Kersten MA, Klont RR, Warris A, Op den Camp HJ, Verweij PE (2004) *Bifidobacterium lipoteichoic* acid and false ELISA reactivity in aspergillus antigen detection. *Lancet* 363:325–327
- Metwally L, Hogg G, Coyle PV, Hay RJ, Hedderwick S, McCloskey B, O'Neill HJ, Ong GM, Thompson G, Webb CH, McMullan R (2007) Rapid differentiation between fluconazole-sensitive and -resistant species of *Candida* directly from positive blood-culture bottles by real-time PCR. *J Med Microbiol* 56:964–970
- Metwally L, Fairley DJ, Coyle PV, Hay RJ, Hedderwick S, McCloskey B, O'Neill HJ, Webb CH, Elbaz W, McMullan R (2008a) Improving molecular detection of *Candida* DNA in whole blood: comparison of seven fungal DNA extraction protocols using real-time PCR. *J Med Microbiol* 57:296–303
- Metwally L, Fairley DJ, Coyle PV, Hay RJ, Hedderwick S, McCloskey B, O'Neill HJ, Webb CH, McMullan R (2008b) Comparison of serum and whole-blood specimens for the detection of *Candida* DNA in critically ill, non-neutropenic patients. *J Med Microbiol* 57:1269–1272
- Meyer W, Castañeda A, Jackson S, Huynh M, Castañeda E, IberoAmerican Cryptococcal Study Group (2003) Molecular typing of IberoAmerican *Cryptococcus neoformans* isolates. *Emerg Infect Dis* 9:189–195
- Milam CP, Fenske NA (1989) Chromoblastomycosis. *Dermatol Clin* 7:219–225
- Millon L, Barale T, Julliot MC, Martinez J, Manton G (1995) Interference by hydroxyethyl starch used for vascular filling in latex agglutination test for cryptococcal antigen. *J Clin Microbiol* 33:1917–1919
- Mishra PK, Fox RT, Culham A (2003) Development of a PCR-based assay for rapid and reliable identification of pathogenic *Fusaria*. *FEMS Microbiol Lett* 218:329–332
- Mitchell TG, Perfect JR (1995) Cryptococcosis in the era of AIDS—100 years after the discovery of *Cryptococcus neoformans*. *Clin Microbiol Rev* 8:515–548
- Mitchell TG, Freedman EZ, White TJ, Taylor JW (1994) Unique oligonucleotide primers in PCR for identification of *Cryptococcus neoformans*. *J Clin Microbiol* 32:253–255
- Miyagi H, Yamamoto Y, Kanamori S, Taira K, Asato Y, Myint CK, Kayo S, Hosokawa A, Hagiwara K, Uezato H (2008) Case of chromoblastomycosis appearing in an Okinawa patient with a medical history of Hansen's disease. *J Dermatol* 35:354–3561
- Miyakawa Y, Mabuchi T, Kagaya K, Fukazawa Y (1992) Isolation and characterization of a species specific DNA fragment for detection of *Candida albicans* by polymerase chain reaction. *J Clin Microbiol* 30:894–900
- Miyakawa Y, Mabuchi T, Fukazawa Y (1993) New method for detection of *Candida albicans* in human blood by polymerase chain reaction. *J Clin Microbiol* 31:3344–3347
- Miyazaki T, Kohno S, Mitsutake K, Maesaki S, Tanaka K, Hara K (1995a) (1 → 3)-β-D-Glucan in culture fluid of fungi activates factor G A limulus coagulation factor. *J Clin Lab Anal* 9:334–339
- Miyazaki T, Kohno S, Mitsutake K, Maesaki S, Tanaka KI, Ishikawa N, Hara K (1995b) Plasma (1–3)-β-D-glucan and fungal antigenemia in patients with candidemia, aspergillosis, and cryptococcosis. *J Clin Microbiol* 33:3115–3118
- Mochizuki T, Tanabe H, Kawasaki M, Ishizaki H, Jackson CJ (2003) Rapid identification of *Trichophyton tonsurans* by PCR-RFLP analysis of ribosomal DNA regions. *J Dermatol Sci* 32:25–32



- Morace G, Sanguinetti M, Posteraro B, Lo Cascio G, Fadda G (1997) Identification of various medically important *Candida* species in clinical specimens by PCR-restriction enzyme analysis. *J Clin Microbiol* 35:667–672
- Morace G, Pagano L, Sanguinetti M, Posteraro B, Mele L, Equitani F, D'Amore G, Leone G, Fadda G (1999) PCR-restriction enzyme analysis for detection of *Candida* DNA in blood from febrile patients with hematological malignancies. *J Clin Microbiol* 37:1871–1875
- Mounds A, Deepe GS (1998) Simultaneous infection with *Blastomyces dermatitidis* and *Cryptococcus neoformans*. *Med Mycol* 36:47–50
- Mulè G, González-Jaén MT, Hornok L, Nicholson P, Waalwijk C (2005) Advances in molecular diagnosis of toxigenic *Fusarium* species: a review. *Food Addit Contam* 22:316–323
- Müller E, von Arx JA (1973) Pyrenomycetes: Meliolales, Coronophorales, Sphaeriales. In: Ainsworth GC, Sparrow FK, Sussman AS (eds) *The fungi: an advanced treatise*, vol 4A. Academic Press, New York, NY, pp 87–132
- Müller FM, Werner KE, Kasai M, Francesconi A, Chanock SJ, Walsh TJ (1998) Rapid extraction of genomic DNA from medically important yeasts and filamentous fungi by high-speed cell disruption. *J Clin Microbiol* 36:1625–2629
- Nagao K, Ota T, Tanikawa A, Takae Y, Mori T, Udagawa S, Nishikawa T (2005) Genetic identification and detection of human pathogenic *Rhizopus* species, a major mucormycosis agent, by multiplex PCR based on internal transcribed spacer region of rRNA gene. *J Dermatol Sci* 39:23–31
- Naidu PS, Zhang YZ, Reddy CA (1990) Characterization of a new lignin peroxidase gene (GLC6) from *Phanerochaete chrysosporium*. *Biochem Biophys Res Commun* 173:994–1000
- Navarro EE, Almario JS, Schaufele RL, Bacher J, Walsh TJ (1997) Quantitative urine cultures do not reliably detect renal candidiasis in rabbits. *J Clin Microbiol* 35:3292–3297
- Nucci M, Marr KA, Queiroz-Telles F, Martins CA, Trabasso P, Costa S, Voltarelli JC, Colombo AL, Imhof A, Pasquini R, Maiolino A, Souza CA, Anaissie E (2004) *Fusarium* infection in hematopoietic stem cell transplant recipients. *Clin Infect Dis* 38:1237–1242
- Ogawa H, Summerbell RC, Clemons KV, Koga T, Ran YP, Rashid A, Sohnle PG, Stevens DA, Tsuboi R (1998) Dermatophytes and host defence in cutaneous mycoses. *Med Mycol* 36:166–173
- Ostrosky-Zeichner L (2003) New approaches to the risk of *Candida* in the intensive care unit. *Curr Opin Infect Dis* 16:533–537
- Pagano L, Fianchi L, Caramatti C, D'Antonio D, Melillo L, Cairra M, Masini L, Todeschini G, Girmenia C, Martino B, Cinieri S, Martino P, Del Bava A, Gruppo Italiano Malattie EMatologiche dell'Adulto Infection Program (2004) Cryptococcosis in patients with hematologic malignancies A report from GIMEMA-infection. *Haematologica* 89:852–856
- Pappagianis D (2001) Serologic studies in coccidioidomycosis. *Semin Respir Infect* 16:242–250
- Pappas PG (2004) Blastomycosis. *Semin Respir Crit Care Med* 25:1131–21
- Paschoal RC, Hirata MH, Hirata RC, Melhem Mde S, Dias AL, Paula CR (2004) Neurocryptococcosis: diagnosis by PCR method. *Rev Inst Med Trop Sao Paulo* 46:203–207
- Patterson JE (2005) In: Mandell GL, Bennet J, Dolin R (eds) *Principles and practice of infectious diseases*, vol 2. Elsevier Churchill Livingstone, New York, NY, pp 2958–2973
- Patterson JE, Peters J, Calhoun JH, Levine S, Anzueto A, Al-Abdely H, Sanchez R, Patterson TF, Rech M, Jorgensen JH, Rinaldi MG, Sako E, Johnson S, Speeg V, Half GA, Trinkle JK (2000) Investigation and control of aspergillosis and other filamentous fungal infections in solid organ transplant recipients. *Transpl Infect Dis* 2:22–28
- Perfect JR, Casadevall A (2002) Cryptococcosis. *Infect Dis Clin North Am* 16:837–874
- Peterson SW, Kurtzman CP (1991) Ribosomal RNA sequence divergence among sibling species of yeasts. *Syst Appl Microbiol* 14:124–129
- Pfaller MA, Diekema DJ (2004) International fungal surveillance participant group 12 years of fluconazole in clinical practice: global trends in species distribution and fluconazole susceptibility of bloodstream isolates of *Candida*. *Clin Microbiol Infect* 10(Suppl 1):11–23
- Pfaller MA, Diekema DJ (2007) Epidemiology of invasive candidiasis: a persistent public health problem. *Clin Microbiol Rev* 20:133–163

- Pham AS, Tarrand JJ, May GS, Lee MS, Kontoyiannis DP, Han XY (2003) Diagnosis of invasive mold infection by real-time quantitative PCR. *Am J Clin Pathol* 119:38–44
- Phillips P, Dowd A, Jewesson P, Radigan G, Tweeddale MG, Clarke A, Greere I, Kelly M (1990) Nonvalue of antigen detection immunoassays for diagnosis of candidemia. *J Clin Microbiol* 28:2320–2326
- Piepenbring M, Cáceres Mendez OA, Espino Espinoza AA, Kirschner R, Schöfer H (2007) Chromoblastomycosis caused by *Chaetomium funicola*: a case report from Western Panama. *Br J Dermatol* 157:1025–1029
- Playford EG, Kong F, Sun Y, Wang H, Halliday C, Sorrell TC (2006) Simultaneous detection and identification of *Candida*, *Aspergillus*, and *Cryptococcus* species by reverse line blot hybridization. *J Clin Microbiol* 44:876–880
- Polesky A, Kirsch CM, Snyder LS, LoBue P, Kagawa FT, Dykstra BJ, Wehner JH, Catanzaro A, Ampel NM, Stevens DA (1999) Airway coccidioidomycosis – report of cases and review. *Clin Infect Dis* 28:1273–1280
- Pounder JI, Hansen D, Woods GL (2006) Identification of *Histoplasma capsulatum*, *Blastomyces dermatitidis*, and *Coccidioides* species by repetitive-sequence-based PCR. *J Clin Microbiol* 44:2977–2982
- Powell BL, Drutz DJ, Huppert M, Sun SH (1983) Relationship of progesterone- and estradiol-binding proteins in *Coccidioides immitis* to coccidioidal dissemination in pregnancy. *Infect Immun* 40:478–485
- Priaryachatigul C, Chaiprasert A, Meevootisom V, Pattanakitsakul S (1996) Assessment of a PCR technique for the detection and identification of *Cryptococcus neoformans*. *J Med Vet Mycol* 34:251–258
- Prentice HG, Kibbler CC, Prentice AG (2000) Towards a targeted, risk-based, antifungal strategy in neutropenic patients. *Br J Haematol* 110:273–284
- Prevost E, Bannister E (1981) Detection of yeast septicemia by biphasic and radiometric methods. *J Clin Microbiol* 12:655–660
- Prince HE, Yeh C, Alem N, Asalkhou M, Hamed N, Alem N, Alem M (2008) Evaluation of enzyme-linked immunosorbent assays for detecting circulating antibodies to *Candida albicans*. *J Clin Lab Anal* 22:234–238
- Putignani L, Antonucci G, Paglia MG, Vincenti L, Festa A, De Mori P, Loiacono L, Visca P (2008a) Cryptococcal lymphadenitis as a manifestation of immune reconstitution inflammatory syndrome in an HIV-positive patient: a case report and review of the literature. *Int J Immunopathol Pharmacol* 21:751–756
- Putignani L, Paglia MG, Bordi E, Nebuloso E, Pucillo LP, Visca P (2008b) Identification of clinically relevant yeast species by DNA sequence analysis of the D2 variable region of the 25–28S rRNA gene. *Mycoses* 51:209–227
- Raad I, Hanna H, Huaranga A, Sumoza D, Hachem R, Albitar M (2002) Diagnosis of invasive pulmonary aspergillosis using polymerase chain reaction-based detection of aspergillus in BAL. *Chest* 121:1171–1176
- Radford A (1993) A fungal phylogeny based upon orotidine-5'-monophosphate decarboxylase. *J Mol Evol* 36:389–395
- Raimondi A, Ticozzi R, Sala G, Bellotti MG (2007) Genotype-based differentiation of the *Cryptococcus neoformans* serotypes by combined PCR-RFLP analysis of the capsule-associated genes CAP10 and CAP59. *Med Mycol* 45:491–501
- Ralph ED, Hussain Z (1996) Chronic meningitis caused by *Candida albicans* in a liver transplant recipient: usefulness of the polymerase chain reaction for diagnosis and for monitoring treatment. *Clin Infect Dis* 23:191–192
- Raman C, Khardori N, Von Behren LA, Wheat LJ, Tewary RP (1990) Evaluation of an ELISA for the detection of anti-*Histoplasma* ribosomal and antihistoplasmin antibodies in histoplasmosis. *J Clin Lab Anal* 4:199–207
- Rantakokko-Jalava K, Laaksonen S, Issakainen J, Vauras J, Nikoskelainen J, Viljanen MK, Salonen J (2003) Semiquantitative detection by real-time PCR of *Aspergillus fumigatus* in

- bronchoalveolar lavage fluids and tissue biopsy specimens from patients with invasive aspergillosis. *J Clin Microbiol* 41:4304–4311
- Rappelli P, Are R, Casu G, Fiori PL, Cappuccinelli P, Aceti A (1998) Development of a nested PCR for detection of *Cryptococcus neoformans* in cerebrospinal fluid. *J Clin Microbiol* 36:3438–3440
- Rath PM, Ansong R (2000) Identification of medically important *Aspergillus* species by single strand conformational polymorphism (SSCP) of the PCR-amplified intergenic spacer region. *Mycoses* 43:381–386
- Reddy LV, Kumar A, Kurup VP (1993) Specific amplification of *Aspergillus fumigatus* DNA by polymerase chain reaction. *Mol Cell Probes* 7:121–126
- Reiss E, Morrison CJ (1993) Nonculture methods for diagnosis of disseminated candidiasis. *Clin Microbiol* 6:311–323
- Revankar SG (2006) Phaeohyphomycosis. *Infect Dis Clin North Am* 20:609–620
- Revankar SG, Patterson JE, Sutton DA, Pullen R, Rinaldi MG (2002) Disseminated phaeohyphomycosis: review of an emerging mycosis. *Clin Infect Dis* 34:467–476
- Revankar SG, Sutton DA, Rinaldi MG (2004) Primary central nervous system phaeohyphomycosis: a review of 101 cases. *Clin Infect Dis* 38:206–216
- Ribes JA, Vanover-Sams CL, Baker DJ (2000) Zygomycetes in human disease. *Clin Microbiol Rev* 13:236–301
- Rickerts V, Loeffler J, Bohme A, Einsele H, Just-Nubling G (2001) Diagnosis of disseminated zygomycosis using a polymerase chain reaction assay. *Eur J Clin Microbiol Infect Dis* 20:744–745
- Rickerts V, Bialek R, Tintelnot K, Jacobi V, Just-Nübling G (2002) Rapid PCR-based diagnosis of disseminated histoplasmosis in an AIDS patient. *Eur J Clin Microbiol Infect Dis* 21:821–823
- Rickerts V, Just-Nübling G, Konrad F, Kern J, Lambrecht E, Böhme A, Jacobi V, Bialek R (2006) Diagnosis of invasive aspergillosis and mucormycosis in immunocompromised patients by seminested PCR assay of tissue samples. *Eur J Clin Microbiol Infect Dis* 25:8–13
- Roden MM, Zaoutis TE, Buchanan WL, Knudsen TA, Sarkisova TA, Schaufele RL, Sein M, Sein T, Chiou CC, Chu JH, Kontoyiannis DP, Walsh TJ (2005) Epidemiology and outcome of zygomycosis: a review of 929 reported cases. *Clin Infect Dis* 41:634–653
- Rodriguez LJ, Rex JH, Anaissie EJ (1996) Update on invasive candidiasis. *Adv Pharmacol* 137:349–400
- Rodriguez LJ, Anaissie EJ, Rex JH (2000) Pneumonia due to *Candida* species. In: Sarosi GA, Davies SF (eds) *Fungal disease of the lung*, 3rd edn. Lippincott Williams & Wilkins, Philadelphia, pp 115–122
- Rodriguez-Tudela J, Diaz-Guerra T, Mellado E, Cano V, Tapia C, Perkins A, Gomez-Lopez A, Rodero L, Cuenca-Estrella M (2005) Susceptibility patterns and molecular identification of *Trichosporon* species *Antimicrob. Agents Chemother* 49:4026–4034
- Rüping MJ, Vehreschild JJ, Cornely OA (2008) Patients at high risk of invasive fungal infections: when and how to treat. *Drugs* 68:1941–1962
- Saha DC, Xess I, Jain N (2008) Evaluation of conventional and serological methods for rapid diagnosis of cryptococcosis. *Indian J Med Res* 12:483–488
- Saiman L, Ludington E, Pfaller M, Rangel-Frausto S, Wiblin RT, Dawson J, Blumberg HM, Patterson JE, Rinaldi M, Edwards JE, Wenzel RP, Jarvis W (2000) Risk factors for candidemia in neonatal intensive care unit patients. *Pediatr Inf Dis J* 19:319–324
- Sanche SE, Sutton DA, Rinaldi MG (2003) Dematiaceous fungi. In: Anaissie EJ, McGinnis MR, Pfaller MA (eds) *Clinical mycology*. Churchill Livingstone, Philadelphia
- Sandhu GS, Kline BC, Stockman L, Roberts GD (1995) Molecular probes for diagnosis of fungal infections. *J Clin Microbiol* 33:2913–2919
- Sanguinetti M, Posteraro B, Pagano L, Pagliari G, Fianchi L, Mele L, La Sorda M, Franco A, Fadda G (2003) Comparison of real-time PCR, conventional PCR, and galactomannan antigen detection by enzyme-linked immunosorbent assay using bronchoalveolar lavage fluid samples from hematology patients for diagnosis of invasive pulmonary aspergillosis. *J Clin Microbiol* 41:3922–3925

- Sanguinetti M, Porta R, Sali M, La Sorda M, Pecorini G, Fadda G, Posteraro B (2007) Evaluation of VITEK 2 and RapID yeast plus systems for yeast species identification: experience at a large clinical microbiology laboratory. *J Clin Microbiol* 45:1343–1346
- Sarkar G, Sommer S (1990) Shedding light on PCR contamination. *Nature* 347:340–341
- Schabereiter-Gurtner C, Selitsch B, Rotter ML, Hirschl AM, Willinger B (2007) Development of novel real-time PCR assays for detection and differentiation of eleven medically important *Aspergillus* and *Candida* species in clinical specimens. *J Clin Microbiol* 45:906–914
- Schwarz P, Bretagne S, Gantier JC, Garcia-Hermoso D, Lortholary O, Dromer F, Dannaoui E (2006) Molecular identification of zygomycetes from culture and experimentally infected tissues. *J Clin Microbiol* 44:340–349
- Segal BH, Walsh TJ (2006) Current approaches to diagnosis and treatment of invasive aspergillosis. *Am J Respir Crit Care Med* 173:707–717
- Selvarangan R, Bui U, Limaye AP, Cookson BT (2003) Rapid identification of commonly encountered *Candida* species directly from blood culture bottles. *J Clin Microbiol* 41:5660–5664
- Sendid B, Tabouret M, Poirot JL, Mathieu D, Fruit J, Poulain D (1999) New enzyme immunoassay for sensitive detection of circulating *Candida albicans* mannan and antimannan antibodies: useful combined test for diagnosis of systemic candidiasis. *J Clin Microbiol* 37:1510–1517
- Sheppard DC, Locas MC, Restieri C, Laverdiere M (2008) Utility of the germ tube test for direct identification of *Candida albicans* from positive blood culture bottles. *J Clin Microbiol* 46:3508–3509
- Singh N, Lortholary O, Alexander BD, Gupta KL, John GT, Pursell K, Munoz P, Klintmalm GB, Stosor V, del Busto R, Limaye AP, Somani J, Lyon M, Houston S, House AA, Pruett TL, Orloff S, Humar A, Dowdy L, Garcia-Diaz J, Kalil AC, Fisher RA, Husain S, Cryptococcal Collaborative Transplant Study Group (2005) An immune reconstitution syndrome-like illness associated with *Cryptococcus neoformans* infection in organ transplant recipients. *Clin Infect Dis* 40:1756–1761
- Sivakumar VG, Shankar P, Nalina K, Menon T (2009) Use of CHROMagar in the differentiation of common species of *Candida*. *Mycopathologia* 167:47–49
- Skladny H, Buchheidt D, Baust C, Krieg-Schneider F, Seifarth W, Leib-Mösch C, Hehlmann R (1999) Specific detection of *Aspergillus* species in blood and bronchoalveolar lavage samples of immunocompromised patients by two-step PCR. *J Clin Microbiol* 37:3865–3871
- Snow RM, Dismukes WE (1975) Cryptococcal meningitis: diagnostic value of cryptococcal antigen in cerebrospinal fluid. *Arch Intern Med* 135:1155–1157
- Spiess B, Buchheidt D, Baust C, Skladny H, Seifarth W, Zeilfelder U, Leib-Mösch C, Mörz H, Hehlmann R (2003) Development of a LightCycler PCR assay for detection and quantification of *Aspergillus fumigatus* DNA in clinical samples from neutropenic patients. *J Clin Microbiol* 41:1811–1818
- Spiess B, Seifarth W, Hummel M, Frank O, Fabarius A, Zheng C, Mörz H, Hehlmann R, Buchheidt D (2007) DNA microarray-based detection and identification of fungal pathogens in clinical samples from neutropenic patients. *J Clin Microbiol* 45:3743–3753
- Spreadbury C, Holden D, Aufauvre-Brown A, Bainbridge B, Cohen J (1993) Detection of *Aspergillus fumigatus* by polymerase chain reaction. *J Clin Microbiol* 31:615–621
- Stockman L, Clark KA, Hunt JM, Roberts GD (1993) Evaluation of commercially available acridinium ester-labeled chemiluminescent DNA probes for culture identification of *Blastomyces dermatitidis*, *Coccidioides immitis*, *Cryptococcus neoformans*, and *Histoplasma capsulatum*. *J Clin Microbiol* 31:845–850
- Suarez F, Lortholary O, Buland S, Rubio MT, Ghez D, Mahé V, Quesne G, Poirée S, Buzyn A, Varet B, Berche P, Bougnoux ME (2008) Detection of circulating *Aspergillus fumigatus* DNA by real-time PCR assay of large serum volumes improves early diagnosis of invasive aspergillosis in high-risk adult patients under hematologic surveillance. *J Clin Microbiol* 46:3772–3777
- Sugita T, Nishikawa A, Shinoda T (1998) Rapid detection of species of the opportunistic yeast *Trichosporon* by PCR. *J Clin Microbiol* 36:1458–1460

- Sugita TA, Nishikawa A, Ikeda R, Shinoda T (1999) Identification of medically relevant *Trichosporon* species based on sequences of internal transcribed spacer regions and construction of a database for *Trichosporon* identification. *J Clin Microbiol* 37:1985–1993
- Sugita T, Nakajima M, Ikeda R, Niki Y, Matsushima T, Shinoda T (2001) A nested PCR assay to detect DNA in sera for the diagnosis of deep-seated trichosporonosis. *Microbiol Immunol* 45:143–148
- Sullivan DJ, Coleman DC (1998) *Candida dubliniensis*; characteristics and identification. *J Clin Microbiol* 31:229–334
- Swanink CM, Meis JF, Rijs AJ, Donnelly JP, Verweij PE (1997) Specificity of a sandwich enzyme-linked immunosorbent assay for detecting *Aspergillus* galactomannan. *J Clin Microbiol* 35:257–260
- Takahashi T, Goto M, Kanda T, Iwamoto A (2003) Utility of testing bronchoalveolar lavage fluid for cryptococcal ribosomal DNA. *J Int Med Res* 31:324–329
- Tanaka KI, Miyazaki T, Maesaki S, Mitsutake K, Kakeya H, Yamamoto Y, Yanagihara K, Hossain MA, Tashiro T, Kohno S (1996) Detection of *Cryptococcus neoformans* gene in patients with pulmonary cryptococcosis. *J Clin Microbiol* 34:2826–2828
- Tang CM, Holden DW, Aufauvre-Brown A, Cohen J (1993) The detection of *Aspergillus* spp by the polymerase chain reaction and its evaluation in bronchoalveolar lavage fluid. *Am Rev Respir Dis* 148:1313–1317
- Tavanti A, Davidson AD, Gow NA, Maiden MC, Odds FC (2005) *Candida orthopsilosis* and *Candida metapsilosis* spp nov to replace *Candida parapsilosis* groups II and III. *J Clin Microbiol* 43:284–292
- Torres HA, Raad II, Kontoyiannis DP (2003) Infections caused by *Fusarium* species. *J Chemother* 15:28–35
- Tortorano AM, Peman J, Bernhardt H, Klingspor L, Kibbler CC, Faure O, Biraghi E, Canton E, Zimmermann K, Seaton S, Grillot R (2004) Epidemiology of candidaemia in Europe: results of 28-month European Confederation of Medical Mycology (ECMM) hospital-based surveillance study. *Eur J Clin Microbiol Infect Dis* 23:317–322
- Trofa D, Gácsér A, Nosanchuk JD (2008) *Candida parapsilosis*, an emerging fungal pathogen. *Clin Microbiol Rev* 21:606–625
- Tsai HF, Liu JS, Staben C, Christensen MJ, Latch GCM, Siegel MR, Schardl CL (1994) Evolutionary diversification of fungal endophytes of tall fescue grass by hybridization with *Epichloë* species. *Proc Natl Acad Sci USA* 91:2542–2546
- Turenne CY, Sanche SE, Hoban DJ, Karlowsky JA, Kabani AM (1999) Rapid identification of fungi by using the ITS2 genetic region and an automated fluorescent capillary electrophoresis system. *J Clin Microbiol* 37:1846–1851
- Turin L, Riva F, Galbiati G, Cainelli T (2000) Fast, simple and highly sensitive double-rounded polymerase chain reaction assay to detect medically relevant fungi in dermatological specimens. *Eur J Clin Invest* 30:511–518
- Umeyama T, Sano A, Kamei K, Niimi M, Nishimura K, Uehara Y (2006) Novel approach to designing primers for identification and distinction of the human pathogenic fungi *Coccidioides immitis* and *Coccidioides posadasii* by PCR amplification. *J Clin Microbiol* 44:1859–1862
- Van Burik JA, Myerson D, Schreckhise RW, Bowden RA (1998) Panfungal PCR assay for detection of fungal infection in human blood specimens. *J Clin Microbiol* 36:1169–1175
- van de Peer Y, Chapelle S, De Wachter R (1996) A quantitative map of nucleotide substitution rates in bacterial rRNA. *Nucleic Acids Res* 24:3381–3391
- van de Peer Y, Jansen J, De Rijk J, De Wachter R (1997) Database on the structure of small ribosomal subunit RNA. *Nucleic Acids Res* 25:111–116
- Veer P, Patwardhan NS, Damle AS (2007) Study of onychomycosis: prevailing fungi and pattern of infection. *Indian J Med Microbiol* 25:53–56
- Vidal MS, Castro LG, Cavalcante SC, Lacaz CS (2004) Highly specific and sensitive, immunoblot-detected 54 kDa antigen from *Fonsecaea pedrosoi*. *Med Mycol* 42:511–515
- Vilchez RA, Fung J, Kusne S (2002) Cryptococcosis in organ transplant recipients: an overview. *Am J Transplant* 2:575–580

- Vollmer T, Störmer M, Kleesiek K, Dreier J (2008) Evaluation of novel broad-range real-time PCR assay for rapid detection of human pathogenic fungi in various clinical specimens. *J Clin Microbiol* 46:1919–1926
- Wadlin JK, Hanko G, Stewart R, Pape J, Nachamkin I (1999) Comparison of three commercial systems for identification of yeasts commonly isolated in the clinical microbiology laboratory. *J Clin Microbiol* 37:1967–1970
- Wahyuningsih R, Freisleben HJ, Sonntag HG, Schnitzler P (2000) Simple and rapid detection of *Candida albicans* DNA in serum by PCR for diagnosis of invasive candidiasis. *J Clin Microbiol* 38:3016–3021
- Walker WF, Doolittle WF (1982) Redividing the basidiomycetes on the basis of 5S rRNA sequences. *Nature* 299:723–724
- Walsh TJ, Francesconi A, Kasai M, Chanock SJ (1995) PCR and single-strand conformational polymorphism for recognition of medically important opportunistic fungi. *J Clin Microbiol* 33:3216–3220
- Wang L, Yokoyama K, Miyaji M, Nishimura K (2000) Mitochondrial cytochrome b gene analysis of *Aspergillus fumigatus* and related species. *J Clin Microbiol* 38:1352–1358
- Wang SM, Hsu CH, Chang JH (2008) Congenital candidiasis. *Pediatr Neonatol* 49:94–96
- Wheat JL (2003) Current diagnosis of histoplasmosis. *Trends Microbiol* 11:488–494
- Wheat LJ, Kauffman CA (2003) Histoplasmosis. *Infect Dis Clin North Am* 17:1–19
- Wheat LJ, Connolly-Stringfield PA, Williams B, Connolly K, Blair R, Bartlett M (1992) Diagnosis of histoplasmosis in patients with the acquired immunodeficiency syndrome by detection of *Histoplasma capsulatum* polysaccharide antigen in bronchoalveolar lavage fluid. *Am Rev Respir Dis* 145:1421–1424
- Wheat LJ, Carringer T, Brizendine E, Connolly P (2002) Diagnosis of histoplasmosis by antigen detection based upon experience at the histoplasmosis reference laboratory. *Diagn Microbiol Infect Dis* 43:29–37
- White PL, Shetty A, Barnes RA (2003) Detection of seven *Candida* species using the Light-Cycler system. *J Med Microbiol* 52:229–238
- White PL, Williams DW, Kuriyama T, Samad SA, Lewis MA, Barnes RA (2004) Detection of *Candida* in concentrated oral rinse cultures by real-time PCR. *J Clin Microbiol* 42:2101–2107
- White PL, Barton R, Guiver M, Linton CJ, Wilson S, Smith M, Gomez BL, Carr MJ, Kimmitt PT, Seaton S, Rajakumar K, Holyoake T, Kibbler CC, Johnson E, Hobson RP, Jones B, Barnes RA (2006) A consensus on fungal polymerase chain reaction diagnosis?: a United Kingdom-Ireland evaluation of polymerase chain reaction methods for detection of systemic fungal infections. *J Mol Diagn* 8:376–384
- Whittier S, Hopfer RL, Gilligan P (1994) Elimination of false-positive serum reactivity in latex agglutination test for cryptococcal antigen in human immunodeficiency virus-infected population. *J Clin Microbiol* 32:2158–2161
- Williamson EC, Leeming JP (1999) Molecular approaches for the diagnosis and epidemiological investigation of *Aspergillus* infection. *Mycoses* 42:S7–10
- Williamson EC, Leeming JP, Palmer HM, Steward CG, Warnock D, Marks DI, Millar MR (2000) Diagnosis of invasive aspergillosis in bone marrow transplant recipients by polymerase chain reaction. *Br J Haematol* 108:132–139
- Wise MG, Healy M, Reece K, Smith R, Walton D, Dutch W, Renwick A, Huang J, Young S, Tarrand J, Kontoyiannis DP (2007) Species identification and strain differentiation of clinical *Candida* isolates using the DiversiLab system of automated repetitive sequence-based PCR. *J Med Microbiol* 56:778–787
- Yamada Y, Makimura K, Uchida K, Yamaguchi H, Osumi M (2004) Phylogenetic relationships among medically important yeasts based on sequences of mitochondrial large subunit ribosomal RNA gene. *Mycoses* 47:24–28
- Yeo SF, Wong B (2002) Current status of nonculture methods for diagnosis of invasive fungal infections. *Clin Microbiol Rev* 15:465–484

- Yokoyama K, Biswas SK, Miyaji M, Nishimura K (2000) Identification and phylogenetic relationship of the most common pathogenic *Candida* species inferred from mitochondrial cytochrome b sequences. *J Clin Microbiol* 38:4503–4510
- Yoshida E, Makimura K, Mirhendi H, Kaneko T, Hiruma M, Kasai T, Uchida K, Yamaguchi H, Tsuboi R (2006) Rapid identification of *Trichophyton tonsurans* by specific PCR based on DNA sequences of nuclear ribosomal internal transcribed spacer (ITS) 1 region. *J Dermatol Sci* 42:225–230
- Zeng X, Kong F, Halliday C, Chen S, Lau A, Playford G, Sorrell TC (2007) Reverse line blot hybridization assay for identification of medically important fungi from culture and clinical specimens. *J Clin Microbiol* 45:2872–2880
- Zhao J, Kong F, Li R, Wang X, Wan Z, Wang D (2001) Identification of *Aspergillus fumigatus* and related species by nested PCR targeting ribosomal DNA internal transcribed spacer regions. *J Clin Microbiol* 39:2261–2266
- Zmeili OS, Soubani AO (2007) Pulmonary aspergillosis: a clinical update. *QJM* 100:317–334

# Chapter 18

## Applications of Loop-Mediated Isothermal Amplification Methods (LAMP) for Identification and Diagnosis of Mycotic Diseases: Paracoccidioidomycosis and *Ochroconis gallopava* infection

Ayako Sano and Eiko Nakagawa Itano

**Abstract** Loop-mediated isothermal amplification (LAMP) methods are now useful for the detection of a specific gene in infectious diseases, genetic diseases, and/or genetic disorders in the large number of medical fields, and it was recently introduced to fungal investigation. It is characterized by the use of four different primers specifically designed to recognize six distinct regions of the target gene, and the reaction process proceeds at a constant temperature using strand displacement reaction. Quickness and simplicity is the advantage of the method. Amplification and detection of gene can be completed in a single step, by incubating the mixture of samples, primers, DNA polymerase with strand displacement activity and substrates at a constant temperature. The method was applied to two fungal infections; paracoccidioidomycosis (PCM), a deep mycosis caused by *Paracoccidioides brasiliensis* and *Ochroconis gallopava* infection. For PCM a combination of F3, B3, FIP, and BIP primers designed from the partial sequence of *P. brasiliensis* *gp43* gene was used. The PCR products amplified by the primer set; F3 and B3 showed species specificity for *P. brasiliensis* and the detection limit of the PCR was 100 fg of fungal genomic DNA. The specific DNA banding pattern of *P. brasiliensis* was detected in the clinical and nine-banded armadillo derived isolates, paraffin-embedded tissue sample or sputum from PCM patient. LAMP method was used also for the identification of *O. gallopava* by using species-specific primer sets based on the D1/D2 domain of the LSU rDNA sequence. The method successfully detected the gene from both fungal DNA derived from brains and spleens of

---

A. Sano

Medical Mycology Research Center, Chiba University, 1-8-1, Inohana, Chuo-ku, 260-8673 Chiba, Japan

e-mail: aya1@faculty.chiba-u.jp

E.N. Itano

Department of Pathological Science, CCB, State University of Londrina, P.O. Box 6001, 86051-970 Londrina, Paraná, Brazil

e-mail: itanoeiko@hotmail.com



experimentally-infected mice with *O. gallopava* and environmental isolates. In conclusion, LAMP method for PCM and *O. gallopava* seemed to be useful for identification, diagnosis or retrospective study with advantage in the quickness and simplicity procedure, but require strictly-controlled environments.

## 18.1 Introduction

The gold standard for diagnosis of fungal infections is detection, isolation and identification of the pathogenic fungi from clinical specimen; such as skin scrapings, hair and nail, mouth and vaginal swabs, blood, cerebrospinal fluid, urine, sputa and respiratory tract secretion, pus, ocular specimen, and organ biopsy. However, there are many complicated problems in clinical laboratories.

First of all, the most important procedure is avoiding laboratory infections caused by highly pathogenic fungal species, such as *Coccidioides immitis*, *C. posadasii*, *Histoplasma capsulatum*, *Blastomyces dermatitidis*, *Paracoccidioides brasiliensis* and *Penicillium marneffeii*. In general, highly pathogenic fungal species are not recommended to isolate clinical laboratories in general (Larone 1995). Furthermore, a fungal infection, caused by *Ochroconis gallopava*, which requires to be differentiated from highly pathogenic bird flu or SARS (Ohori et al. 2006), is also recommended to diagnose without culturing to avoid the viral laboratorial infections.

The lower rate of isolation of the causative agents seems to be caused by short incubation periods for the isolation of fungi from clinical material. Visualization of fungal sprouts from clinical materials takes a longer time than those of bacteria. It takes at least 48 h in pathogenic yeasts, 4–7 days in common pathogenic filamentous fungi; dermatophytes, *Aspergillus* spp., zygomycetes, and others, almost 10–14 days in dematiaceous fungi, and 3 weeks or more in particular fungal species, especially *P. brasiliensis*, of course, it should not try to isolate in general laboratories. But most laboratories could not keep incubating more than 1 week. Therefore, the isolation rate of filamentous fungal pathogens seems to be very low compared to pathogenic yeasts.

Followed by difficulties in isolations of fungal pathogens, there is a serious problem with identification. Expert skills for identification based on morphological and physiological characteristics are strongly required. The procedures are highly time-consuming to prepare photogenic samples and to evaluate special morphological and physiological characteristics (Ohori et al. 2006). Furthermore, clinical isolates sometimes lacked characteristic appearances such as textures and colors of colonies, conidiogenesis, mating and physiological abilities (Uno et al. 2001).

Diagnosis for fungal infections is able to be confirmed on the basis of combinations of clinical findings, diagnostic imagings, serological tests, immunological

tests, cytological and histopathological findings without the fungal isolate (Ishikawa et al. 2008).

Detections of 1,3-beta-D-glucan, galactomannan, and D-arabinitol from sera are faster than other methods, and are also useful for diagnosis of some fungal infections (Christensson et al. 1999; Kelaher 2006), however, it is impossible to estimate the species of the causative agent.

Isolation and identification, and detection of a species-specific gene by molecular biological methods from clinical materials are able to confirm the causative agent in the species level (Borman et al. 2008).

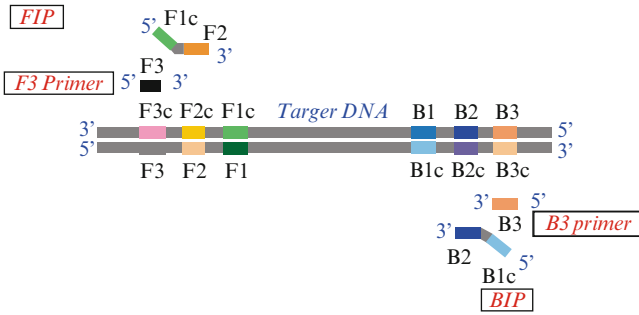
Following the developments of molecular biological techniques in these two decades, molecular biological data for identification of fungal species based on ribosomal DNA (rDNA) sequences became common, such as for *P. brasiliensis* identification (Motoyama et al. 2000). Although internal transcribed spacer 1 region of rDNA sequence (ITS 1 rDNA) is treated as a barcode gene for identification and taxonomical classification of fungi (Druzhinina 2005), there were some difficulty to confirm the fungal species based on the gene sequences. Therefore, selection of species-specific genes, beside the ITS 1 rDNA may add value to targets.

Detections of species-specific genes derived from causative agents in clinical materials by polymerase chain reactions (PCR) have been reported in many mycotic diseases (Reiss et al. 2000; Balajee et al. 2007). But, it still takes at least several hours to obtain the results and sometimes should be requested to confirm the sequences of the amplified genes. Therefore, rapid and accurate diagnostic methods based on molecular biological techniques have been waited for.

Notomi et al. in 2000 reported a new method, the so called loop-mediated isothermal amplification (LAMP) method to detect specific gene from a DNA virus within a few hours. The method has been applied in the field of microbiology for detection and identification of *Mycobacterium* sp. (Iwamoto et al. 2003), hepatitis B virus (Nagamine and Watanabe 2001; Nagamine et al. 2002), highly pathogenic bird flu (Imai et al. 2007) and many other pathogens reaching to more than 200 reports up to the end of November 2008.

On the other hand, the technique has not been successful in applying fungal infections. Personal communications suggested that the LAMP methods are useful for opportunistic fungal infection in the early times; however, our opinion is that the LAMP methods for *Candida* spp., *Aspergillus* spp., and other opportunistic fungal species may not be reliable because of the difficulties to judge the real pathogen or environmental contaminant. We would like to suggest that the application of the LAMP methods to mycotic diseases should be limited to the highly pathogenic fungal species out of endemic areas, and/or to rare species, for example *Cryptococcus gattii* (Lucas et al. 2009), although a LAMP method for identification of *Candida* spp. was reported by Inácio et al (2008).

The present chapter describes the principle of LAMP method, detections of specific gene from *P. brasiliensis* categorized as one of the highly pathogenic fungi (Endo et al. 2004), and of *O. gallopava* required to be differentiated from highly pathogenic bird flu or SARS (Ohori et al. 2006).



**Fig. 18.1** Design 4 types of primers based on the following six distinct regions of the target gene: the F3c, F2c and F1c regions at the 3' side and the B1, B2 and B3 regions at the 5' side. FIP: Forward Inner Primer consists of the F2 region (at the 3' end) that is complementary to the F2c region, and the same sequence as the F1c region at the 5' end. F3 Primer: Forward Outer Primer consists of the F3 region that is complementary to the F3c region. BIP: Backward Inner Primer consists of the B2 region (at the 3' end) that is complementary to the B2c region, and the same sequence as the B1c region at the 5' end. B3 Primer: Backward Outer Primer consists of the B3 region that is complementary to the B3c region (<http://loopamp.eiken.co.jp/e/lamp/primer.html>)

## 18.2 The Principle of LAMP Method

### 18.2.1 About LAMP Method (<http://loopamp.eiken.co.jp/e/lamp/index.html>)

LAMP method which stands for LAMP is a simple, rapid, specific and cost-effective nucleic acid amplification method solely developed by Eiken Chemical Co., Ltd. It is characterized by the use of four different primers specifically designed to recognize six distinct regions on the target gene and the reaction process that proceeds at a constant temperature using strand displacement reaction (Fig. 18.1).

Amplification and detection of genes can be completed in a single step, by incubating the mixture of samples, primers, DNA polymerase with strand displacement activity and substrates at a constant temperature (about 65°C). It provides high amplification efficiency, with DNA being amplified  $10^9$ – $10^{10}$  times in 15–60 min. Because of its high specificity, the presence of amplified product can indicate the presence of the target gene.

### 18.2.2 Primers

LAMP method uses four primer sets; F3, B3, FIP and BIP selected from six distinct regions of the target gene (<http://loopamp.eiken.co.jp/e/lamp/primer.html>). The most important primer set is F3 and B3. The primers should be selected from specific genes or gene sequences based on species specific PCR and confirmed after

testing with intra species diversity and a huge numbers of related pathogenic fungal species.

Therefore, enormous numbers of trials and errors are latent until the final primers are confirmed. Furthermore, the primers should completely differentiate the fungal genes from host ones.

Although, special software to design LAMP primers- PrimerExplore is available in the website (<http://primerexplorer.jp/e/>), it seemed to be useful as reference hints for base composition, GC contents, secondary structures and Tm value on designing primers based on our experience.

### **18.2.3 Basic Principle**

The target gene (DNA template as example) and the reagents are incubated at a constant temperature between 60–65°C. The reaction steps are available at the website (<http://loopamp.eiken.co.jp/e/lamp/principle.html>).

### **18.2.4 Cautions**

LAMP method is highly sensitive. We experienced many faults of contamination of the genes. Once contamination of the target gene occurs, all reactions become positive, even in a negative control using distilled water as a template. Therefore, extremely careful procedures are requested. Reagents, pipets, plastic pipet tips, safety cabinet, and hands. The samples should be handled separately from the reagents. The positive control for the target gene should be done separately.

This is one of the reasons why some fungal species common in normal human flora or in environments are not recommended to use the LAMP method. Selection of the target fungal species is also important. The fungal species should be rare in laboratorial environment.

## **18.3 Applications of LAMP Method for Identifications of *P. brasiliensis* and or/Diagnosis for Paracoccidioidomycosis (PCM)**

### **18.3.1 Backgrounds for *P. brasiliensis***

*P. brasiliensis* is considered to belong to the family Onygenaceae (Order Onygenales, Ascomycota), in the same group as *Blastomyces dermatitidis*, *Coccidioides immitis*, *Histoplasma capsulatum*, and *Lacazia loboi* (Bagagli et al. 2008). The

fungal species is treated as one of the highly pathogenic fungi categorized as biosafety level 3 as the same as *C. immitis*, *C. posadasii*, *H. capsulatum*, *B. dermatitidis* and *Penicillium marneffei* (Kamei et al. 2003). On the other hand, the identification and diagnosis of the above fungal infections with nonculture method seems to be very important to avoid laboratory infection (Kamei et al. 2003, Umeyama et al. 2006).

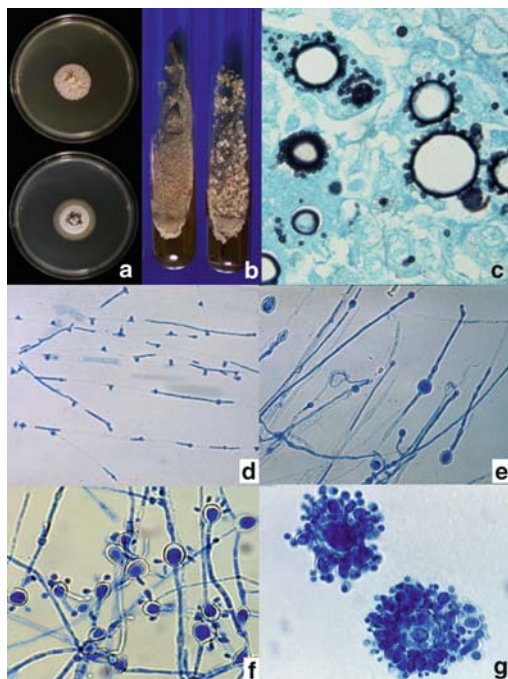
*P. brasiliensis* is the causative agent for paracoccidioidomycosis (PCM) endemic in Latin American countries. This fungus invades the lungs, lymph nodes, skin, mucosa, liver, spleen and various other organs of humans and dogs. In humans, the disease is characterized by two clinical forms: the acute or juvenile form (AF) and more frequently chronic or adult form (CF). The AF is prevalent in children and young people and presents a more severe and rapid clinical evolution with the involvement of multiple organs and adenomegaly, hepatosplenomegaly, digestive disorders, osteo-articular involvement and muco-cutaneous lesions. The CF occurs mainly in adult males and has multiple forms, ranging from benign and localized (unifocal) to severe and disseminated (multifocal) disease that involves skin, mucous membranes, pulmonary and lymph node manifestations (Restrepo 1985; Franco 1987; Kwon-Chung and Bennett 1992; Brummer et al. 1993; Ono et al. 2003; Ricci et al. 2004).

The probable natural habitat of *P. brasiliensis* is soil as saprophytic form. In fact, isolations from soil or soil related products, from the feces of both frugivorous bats (*Artibeus lituratus*) and a penguin (*Pygoscelis adeliae*) were reported. Interestingly, the natural reservoir of *P. brasiliensis* seems to be the nine-banded armadillo (*Dasybus novemcinctus*) because of repeated isolation of the fungal species from various endemic areas of paracoccidioidomycosis with high incidences showing, as the same genetic profiles as clinical isolates. Furthermore, detection of *P. brasiliensis* gene from the internal organs of wild animals that died in traffic accidents; guinea pig (*Cavia aperea*), porcupine (*Sphiggurus spinosus*), grison (*Galictis vittata*) and raccoon (*Procyon cancrivorus*) suggested that the mycosis invades not only humans but also many mammal species, and is one of zoonotic mycosis (Bagagli et al. 2008).

The characteristics of *P. brasiliensis* is temperature-dependent dimorphism; a mycelial form at ambient temperature, and multiple budding yeast form in host tissue or at temperatures above 35–37°C in certain culture media (Restrepo 1985; Franco 1987; Franco et al. 1989; Kwon-Chung and Bennett 1992; Brummer et al. 1993). (Fig. 18.2).

The important characteristics of *P. brasiliensis* are a multiple-nuclei microorganism (Imai et al. 2000), and a haploid microorganism except for *gp43*, encoding the major antigen of *P. brasiliensis*; 43 kDa glycoprotein appeared as only one allele (Almeida et al. 2007). The mature or during maturation of yeast cells that have multiple nuclei, suggested that any *P. brasiliensis* gene may easily be amplified because of multiple copies at least. It suggested that selection of the target gene is free from sticking on ribosomal RNA genes having tandem repeats (Kobayashi 2006) from clinical materials.

**Fig. 18.2** (a) Upper; colony of *P. brasiliensis* cultured on Sabouraud dextrose agar plate, lower; on potato dextrose agar plate at 25°C for 8 weeks, (b) cerebriiform yeast-like colony on 1% dextrose added brain heart infusion agar slant cultured at 35°C for 7 days (left; nine-banded armadillo derived isolate, right; clinical isolate), (c) whip wheel like appearance in a infected lymphonode tissue (Dr. Nakajima Y, Matsushita Memorial Hospital, Osaka, Japan), (d) aleurioconidia cultured on potato dextrose agar at 25°C for 8 weeks, (e) clamydospores cultured on potato dextrose agar at 25°C for 8 weeks, (f) mycelial to yeast form conversion process cultured on potato dextrose agar at 25°C for 2 weeks and cultured at 35°C for 3 days, (g) multiple budding yeast cells consisted of big mother cells, daughter and grand daughter cells



Genetic data of *P. brasiliensis* have progressed in the twenty first century. More than 5,000 sequences of *P. brasiliensis* are released into the GenBank database (<http://www.ncbi.nlm.nih.gov/sites/entrez>).

Based on multiple gene analysis, *P. brasiliensis* was separated into three different phylogenetic species; S1 (species 1 from Brazil, Argentina, Paraguay, Peru and Venezuela), PS2 (phylogenetic species 2 from Brazil and Venezuela) and PS3 (phylogenetic species 3 from Colombia) (Matute et al. 2006a, b, 2007).

Whole genome sequences on three strains of *P. brasiliensis* (Pb01, Pb03 and Pb18) were released in the BROAD Institute ([http://www.broad.mit.edu/annotation/genome/paracoccidioides\\_brasiliensis/MultiHome.html](http://www.broad.mit.edu/annotation/genome/paracoccidioides_brasiliensis/MultiHome.html)). According to Carrero et al. 2008, isolate Pb01 might be a new *Paracoccidioides* species because of its diversity of gene profiles compared to other *P. brasiliensis* isolates, and was named as *P. lutzii* (Teixeira et al. 2009).

Among various genes, the *gp43* is the most important gene because of its diagnostic value (Puccia et al. 2008). We have also been trying to detect *gp43* from paraffin embedded tissue samples and blood (Sano et al. 2001; Itano et al. 2002).

The gene encodes the major fungal antigen; 43 kDa glycoprotein, which is a dominant *P. brasiliensis* antigen, and has been used for serological test in endemic areas (Miura et al. 2001; Camargo 2008).

Approximately 300 sequences of *gp43* were released in the GenBank database at the end of August 2009. The gene homologies among the majority of *P. brasiliensis* isolates is more than 96% in, except for Pb01 and its related isolates identity (Teixeira et al. 2009, Takayama et al. 2009). According to Takayama et al., the LAMP band pattern of *P. lutzii* was different from those of *P. brasiliensis*.

### 18.3.2 LAMP Method for Identifications of *P. brasiliensis*

#### 18.3.2.1 *P. brasiliensis* Isolates and Reference Species

Twenty-two clinical and seven nine-banded armadillo (*Dasypus novemcinctus*) derived *P. brasiliensis* isolates were tested.

As an advanced notice, our method might limit to detect S1 phylogenetic type of *P. brasiliensis* since we have not tested the isolates belonging to PS2 and PS3 proposed by Matute et al. 2006a and b. Furthermore, there is an uncertainty to detect *gp43* in atypical isolate *P. brasiliensis* strain Pb01 and its related isolates (Carrero et al. 2008; Takayama et al. 2009), and has just been named as the new species *P. lutzii* (Teixeira et al. 2009).

Isolates of *Coccidioides immitis sensu lato* (IFM 50993, identified as *C. posadasii* based on multiple gene analysis by Sano et al. 2006), *Histoplasma capsulatum* (IFM 41329), *Blastomyces dermatitidis* (IFM 41316), *Sporothrix schenckii* (IFM 47068), *Penicillium marneffeii* (IFM41708), *Candida albicans* (IFM 5740), and *Cryptococcus neoformans* (IFM 5830) were used as negative controls (Table 18.1).

#### 18.3.2.2 Extraction of DNA

Isolates of *P. brasiliensis* were evaluated. Yeast-form cells harvested on 1.0% glucose added Difco™ brain heart infusion agar (Becton Dickinson Microbiology Systems, Sparks, MD, USA) slants at 35°C for 7 days were used. Approximately  $5 \times 10^8$  yeast-form cells were suspended in distilled water (DW) and washed three times with DW, and homogenized in a 1.5 mL volume plastic homogenizer. DNA was extracted with the Gen Toru Kun for the yeast (Dr. GenTLE™ for yeast) kit (TAKARA BIO INC., Ohtsu, Shiga, Japan).

Isolates of *C. posadasii*, *H. capsulatum*, *B. dermatitidis*, *S. schenckii*, *P. marneffeii*, *Ca. albicans*, and *Cr. neoformans* were cultured on potato dextrose agar (Becton Dickinson Microbiology Systems) at 25°C for 7–60 days.

The fungal cells of *C. posadasii* were fixed with 70% ethanol overnight, and the DNA was extracted by the kit (Dr. GenTLE™ for yeast, TAKARA BIO INC.). The final concentrations of DNA were adjusted from 10 to 20 ng/mL.

Table 18.1 Isolates

IFM Number	Strain	Country (City)	Source (Remarks)	Phylogenetic species <sup>a</sup>	Accession no. (gp43)
<i>Paracoccidioides brasiliensis</i>					
IFM 41620	Pb-9	Brazil	Human patient	SI	AB047690
IFM 41621	Pb-18	Brazil	Human patient	SI	AB047691
IFM 41622	Bt-2	Brazil (Botucatu, São Paulo)	Human patient	SI	AB304676
IFM 41623	Bt-3	Brazil (Botucatu, São Paulo)	Human patient	SI	AB304677
IFM 41624	Bt-4	Brazil (Botucatu, São Paulo)	Human patient	SI	AB047693
IFM 41625	Bt-7	Brazil (Botucatu, São Paulo)	Human patient	SI	AB304678
IFM 41626	Bt-9	Brazil (Botucatu, São Paulo)	Human patient	SI	AB047694
IFM 41628	B1183	Brazil	Human patient	ND	ND
IFM 41629	PbLev	Brazil	Human patient	SI	AB304680
IFM 41630	B339	Brazil	Human patient	SI	AB304681
(=CBS 372.73, =ATCC 32069)					
IFM 41631	Recife	Brazil (Recife)	Human patient	SI	AB304682
IFM 41632	Pb-HM-AOK	Japan (Tokyo) <sup>b</sup>	Human patient	SI	AB047695
IFM 41633	Hachisuga	Japan (Fukuoka) <sup>b</sup>	Human patient	SI	AB304682
IFM 46215	WAG	Japan (Osaka) <sup>c</sup>	Human patient	SI	AB047696
IFM 46240	Tateishi	Japan (Ibaragi) <sup>b</sup>	Human patient	SI	AB304684
IFM 46464	Bt-1	Brazil (Botucatu, São Paulo)	Human patient	SI	AB304685
IFM 46465	Pb-267	Brazil	Mutant of Pb-9	SI	AB047692
IFM 46466	Pb-265	Brazil	Mutant of Pb-9	SI	AB304686
IFM 46467	Recife-Pb-HC	Brazil (Recife)	Human patient	SI	AB047699
IFM 46468	P-25	Costa Rica (San Jose)	Human patient	ND	AB047698
IFM 46470	P-30	Costa Rica (San Jose)	Human patient	ND	AB304688
IFM 46930	UMK	Japan (Chiba) <sup>b</sup>	Human patient	SI	AB047697
IFM 46463	Tatu	Brazil (Botucatu, São Paulo)	Armadillo	SI	AB047700
IFM 47183	PRT1	Brazil (Botucatu, São Paulo)	Armadillo	SI	AB047701
IFM 47185	PRT2	Brazil (Botucatu, São Paulo)	Armadillo	SI	AB047702
IFM 47195	D3LY1	Brazil (Botucatu, São Paulo)	Armadillo	SI	AB047813
IFM 47217	D4S1	Brazil (Botucatu, São Paulo)	Armadillo	SI	AB047704

(continued)



Table 18.1 (continued)

IFM Number	Strain	Country (City)	Source (Remarks)	Phylogenetic species <sup>a</sup>	Accession no. (gp43)
IFM 47228	D4S9	Brazil (Botucatu, São Paulo)	Armadillo	SI	AB047703
IFM 47247	D4LIV1	Brazil (Botucatu, São Paulo)	Armadillo	SI	AB047705
<i>Coccidioides immitis</i> sensu lato					
<i>(C. posadasii)</i>					
IFM 50993		USA	Human patient	—	—
<i>Histoplasma capsulatum</i>					
IFM 41329		USA	Human patient	—	—
<i>Blastomyces dermatitidis</i>					
IFM 41316		USA	Human patient	—	—
(=ATCC 26199)					
<i>Sporothrix schenckii</i>					
IFM 47068		Japan	Human patient	—	—
<i>Penicillium marneffeii</i>					
IFM 41708		China	Bamboo rat	—	—
<i>Candida albicans</i>					
IFM 5740		Japan	Human patient	—	—
<i>Cryptococcus neoformans</i>					
<i>sensu lato</i>					
IFM 5830		Japan	Human patient	—	—

IFM Institute of Food Microbiology, Chiba University, the former name of the Medical Mycology Research Center, and deposited as the official abbreviation of the world culture collection of pathogenic fungi and actinomycetes

<sup>a</sup>Phylogenetic species was estimated from *gp43* sequence

<sup>b</sup>The patient was infected in Brazil

<sup>c</sup>The patient was infected in Paraguay

ND Not determined

DNA extracted from a paraffin-embedded tissue sample of PCM and an ethanol-fixed sputum sample was extracted with a DEXPAT kit (TAKARA BIO INC.) and was also used in the LAMP assay.

### 18.3.2.3 Detection of *gp43* by PCR

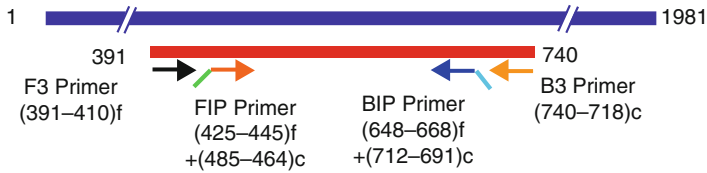
A total volume of 25  $\mu\text{L}$  was used for all PCR reactions. Fifty nanograms per milliliter of DNA extracts were added to 2.5  $\mu\text{L}$  of Ex Taq<sup>TM</sup> buffer in the kit (Ex Taq<sup>TM</sup>, TAKARA BIO INC.) containing 4.5 mM MgSO<sub>4</sub>, 2  $\mu\text{L}$  (2.5 mM each) dNTP mixture in the kit (Ex Taq<sup>TM</sup>, TAKARA BIO INC.), 2  $\mu\text{L}$  each 10 pM primer set of F3 5'-TCA CGT CGC ATC TCA CAT TG-3' encoding from 391st to 410th and B3 5'-AAG CGC CTT GTC CAA ATA GTC GA-3' designed from the complementary sequence from 718th to 740th correspondent to *gp43* sequence at GenBank U26160 and 0.0625  $\mu\text{L}$  (5 units/ $\mu\text{L}$ ) TaKaRa Ex Taq<sup>TM</sup> polymerase in the kit (Ex Taq<sup>TM</sup>, TAKARA BIO INC.). Reaction mixtures were subjected to denaturation at 94°C for 1 min, followed by 30 cycles of amplification at 94°C for 1 min, 50°C for 1 min, and 72°C for 2 min and a final extension at 72°C for 10 min, in a PCR Thermal Cycler MP (TAKARA BIO INC.). PCR products were separated by electrophoresis on 1.0% agarose gels in TAE buffer (40 mM Tris-base, 20 mM acetic acid, 1 mM EDTA), stained with ethidium bromide, and visualized by UV transillumination. DNA strands obtained from the PCR were processed for direct sequencing with ABI Prism 3,100 (Applied Biosystems, Foster City, CA., USA) to confirm the sequence of *gp43* (Sano et al. 1998–1999).

### 18.3.2.4 LAMP Method for *gp43*

Briefly, the LAMP method used in the present study detects the *gp43* gene with a combination of F3, B3, FIP, and BIP primers designed from the partial sequence of *gp43* (GenBank accession number U26160) by a registration system primer designing website (FUJITSU Ltd., Tokyo, Japan: “LAMP PIMER EXPLORER” website in “Netlaboratory” homepage <http://venus.netlaboratory.com/partner/lamp/index.html>). These primers recognize a partial sequence of *gp43*.

The primer sequences were as follows: F3, used in the species specific forward primer; B3, used in the species-specific reverse one; FIP, 5'-TGG CTC CAG CAA TAG CCA CCC GTC AAG CAG GAT CAG CAA T-3' designed from the forward sequence of 425th to 445th and the complementary sequence of 464th to 485th; and BIP: 5'-CAT GTC AGG ATC CCG ATC GGG CCT TGT ACA TAT GGC TCT CCC T-3' designed by the forward sequence from 648th to 668th and the complementary sequence from 691st to 712th. The annealing sites of the primers are shown in Fig. 18.3.

One micro liter of 10 ng/mL DNA template and 40 pmol each of the FIP and BIP primers and 5 pmol each of the F3 and B3 primers were mixed with 12.5  $\mu\text{L}$  of 2 reaction mix in the kit (Loop AMP, Eiken Chemical Co., Ltd., Tokyo, Japan) in a



**Fig. 18.3** Primer map for the LAMP method of detecting *gp43* from *P. brasiliensis*

final volume of 23.0  $\mu$ L. DNA mixtures were incubated at 63°C for 60 min. The reaction was stopped by heating the mixture at 80°C for 2 min to inactivate the enzyme of LAMP amplification. Detection limits of the LAMP method were evaluated with serial dilutions of DNA from isolate IFM 46930.

As the positive control attached with the kit and a negative control consisted of DW and other fungal DNAs, *C. immitis*, *H. capsulatum*, *B. dermatitidis*, *S. schenckii*, *P. marneffei*, *C. albicans*, and *Cr. neoformans* were used. In addition, DNAs extracted from a paraffin-embedded tissue sample, and an ethanol-fixed sputum were reacted at 63°C for 60 and 120 min.

In addition, time-dependent increases in levels of DNA products by LAMP were monitored by real-time-PCR (Rotor-Gene, RG2000, NIPPON/Techno Cluster, Inc., Tokyo, Japan) for as long as 70 min at 63°C with *P. brasiliensis* isolates IFM 41630 and IFM 46215.

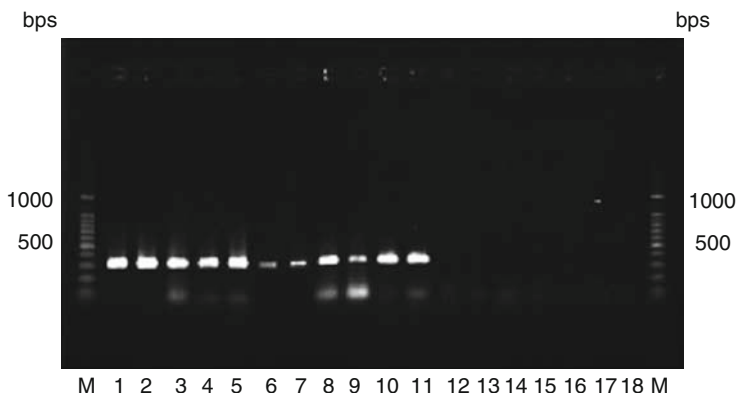
## 18.4 Results

The PCR products amplified with the primer set; F3 and B3 showed species specificity for *P. brasiliensis*. The detection limit of the PCR was 100 fg of fungal genomic DNA (data not shown). Other related species, such as *C. posadasii* (not shown), *H. capsulatum*, and *B. dermatitidis* or important pathogenic fungi; *S. schenckii*, *P. marneffei*, *Ca. albicans*, and *Cr. neoformans* were negative (Fig. 18.4).

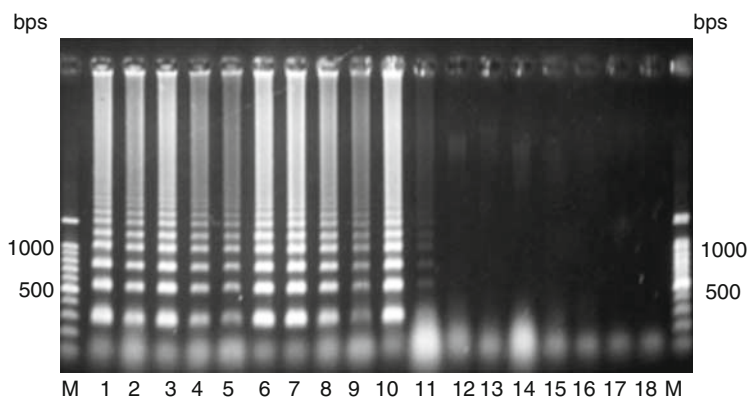
All partial sequences of *gp43* consisted of 339 bps and were correspondent to their accession numbers, except for isolate IFM 41628 (not done).

The specific DNA banding pattern of *P. brasiliensis* was detected in the clinical and nine-banded armadillo derived isolates by LAMP. No DNA band was observed in negative control isolates of *C. posadasii*, *H. capsulatum*, *B. dermatitidis*, *S. schenckii*, *P. marneffei*, *C. albicans*, and *Cr. neoformans* (Fig. 18.5). The detection limit of LAMP for *gp43* was also 100 fg of fungal genomic DNA.

The incubation procedure at 63°C for 60 min was not sufficient for detection of *gp43* from DNA extracted from paraffin-embedded tissue sample or sputum infected with PCM (data not shown). The DNA from a paraffin-embedded tissue and sputum from different patients yielded the same ladder band yielded by fungal DNAs *via* LAMP at 63°C for 120 min (Fig. 18.6a, b).



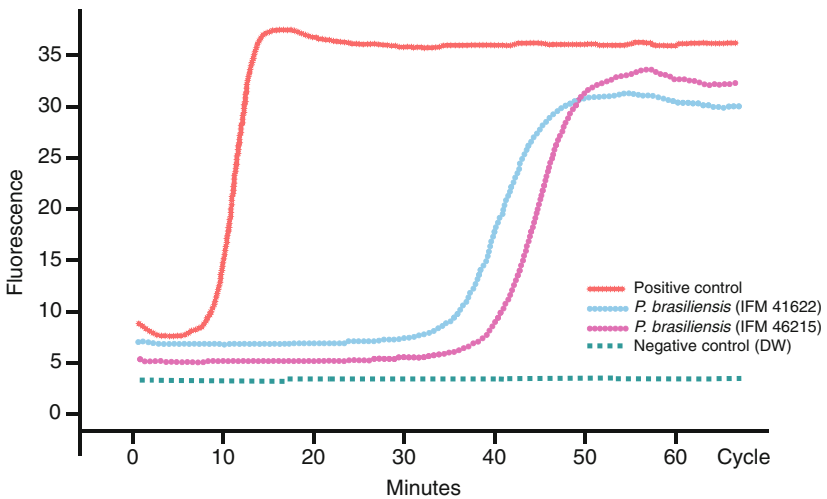
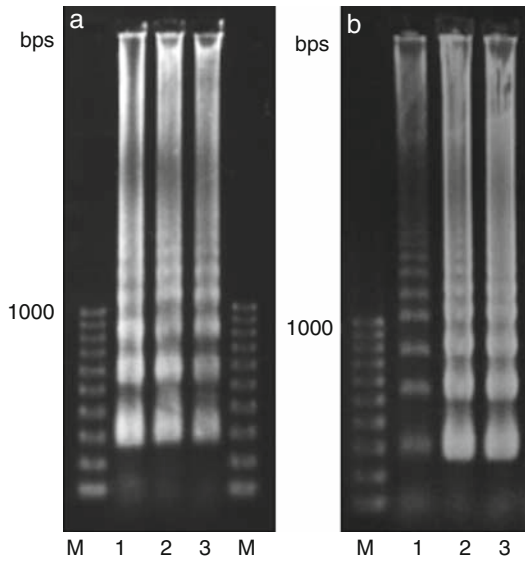
**Fig. 18.4** Amplification of the *gp43* gene by PCR with primers F3 and B3. All DNA derived from *P. brasiliensis* isolates (line 1–11) were uniformly positive. 12: *Ca. albicans*, 13: *H. capsulatum*, 14: *B. dermatitidis*, 15: *P. marneffeii*, 16: *S. schenckii*, 17: *Cr. neoformans*, and 18: *C. immitis* (*C. posadasii*) were negative



**Fig. 18.5** Amplification of the *gp43* gene by the LAMP methods. All DNA derived from *P. brasiliensis* isolates (line 1–11) were uniformly positive. 12: *Ca. albicans*, 13: *H. capsulatum*, 14: *B. dermatitidis*, 15: *P. marneffeii*, 16: *S. schenckii*, 17: *Cr. neoformans*, and 18: *C. immitis* (*C. posadasii*) were negative

The LAMP reaction reached a plateau after incubation at 63°C for 45 min, so far, as monitored by real time- PCR (Fig. 18.7). The positive control provided with the kit reached a plateau at 15 min, and the negative one did not show increase of fluorescence level. DNAs from other fungal species did not increase the fluorescence level (data not shown). The LAMP reaction of DNA from isolate IFM 46215 reached a plateau at 63°C for 45 min and those of IFM 41622 was 50 min.

**Fig. 18.6** (a) Amplification of the *gp43* from paraffin embedded tissue sample by the LAMP methods. M: Marker, 2: DNA from the paraffin embedded tissue sample. 3 and 4: Fungal DNA of *P. brasiliensis*. (b) Those from sputa. M: marker, 2: DNA from the sputum, 3 and 4: Fungal DNA of *P. brasiliensis*



**Fig. 18.7** LAMP reaction monitored by real-time-PCR. The negative control with other fungal DNAs, *C. immitis* (*C. posadasii*), *H. capsulatum*, *B. dermatitidis*, *S. schenckii*, *P. marneffei*, *Ca. albicans*, and *Cr. neoformans* were as the same as DW

### 18.5 Comments and Opinions

The LAMP method provides for more rapid detection of *gp43* than nested PCR. LAMP required only 3 h from DNA extraction to identification, whereas nested PCR required 12 h when we tested.

LAMP methods are also advantageous because it can be applied to clinical material, such as paraffin-embedded tissue and sputum samples for retrospective study (Endo et al. 2004; Tatibana et al. 2009). Even in clinical samples, the time required for diagnosis was less than 4 h.

The LAMP method is not only convenient for identification of *P. brasiliensis*, but also for diagnosis of PCM, especially for identification of *P. brasiliensis* and diagnosis of PCM outside of the endemic areas, such as European countries and Japan. Patients in endemic areas are sometimes misdiagnosed as having a malignant tumor because of a shadow on the chest X-ray and granulomatous inflammation of infected tissue. Therefore, most PCM of patients in Japan are being diagnosed on the basis of histopathological findings (Endo et al. 2004). The LAMP method could be applied for PCM diagnosis in such cases without isolation of the fungus.

Application of real-time-PCR to the LAMP method should shorten the time for obtaining the results within a couple of hours, because electrophoresis is not required. While analysis of LAMP amplification products by agarose gel electrophoresis takes approximately 3 h, LAMP in connection with real-time-PCR takes only 2 h.

According to the manufacturer's protocol, LAMP products can be detected by optical density under UV light. However, we do not recommend this method. Some of pseudo reactions showing smear-like amplification products also became positive. Furthermore, we do not have any experience to react as a smear-like amplification in the real-time PCR method. Uncertainty of the reaction also could not be removed. Therefore, LAMP products should be visualized by agarose gel electrophoresis.

In addition, the reaction does not require a special thermo cycler system. A styrofoam box with warm water like that of a hot coffee temperature is one sign of a good apparatus. It suggested that the method is useful in field hospitals.

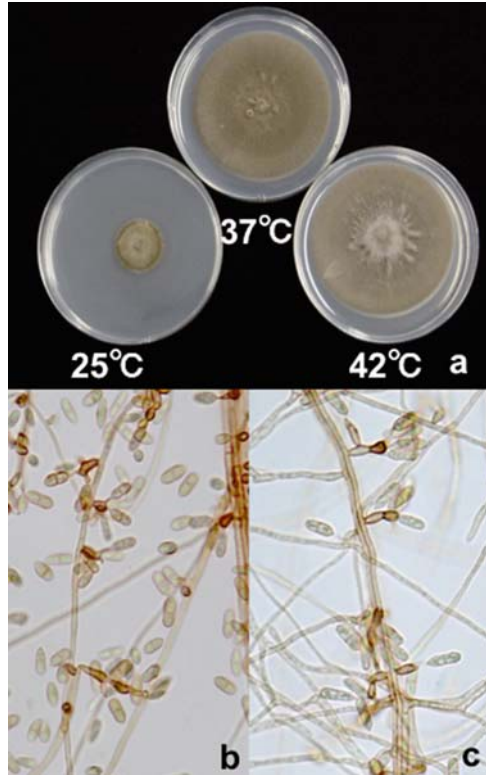
This method will be important for detecting specific genes in highly pathogenic or rare emerging fungal infections which require care and time-consuming culturing procedures.

However, because of extremely higher sensitivities to detecting genes by the LAMP methods, it should be meaningless to apply the LAMP methods to *Candida* species that exist as common fungal flora in oral or body surface, to *Aspergillus* species and/or to other causative agents for the emerging fungal infections habitat popular in soil or environments. It should be impossible to judge the results whether it is environmental contaminations or real infectious propague. In addition, we would like to avoid to give a comment on the report by Inácio et al (2008).

## 18.6 LAMP Method for Identifications of *O. gallopava*

We also applied the LAMP method to detection of the species-specific gene of *O. gallopava*; a species of dematiaceous fungi recognized as a causative agent of zoonotic and emerging fungal infections. The fungal species shows excellent growth at 42°C (Fig. 18.8a), and is able to grow up to 45°C or more.

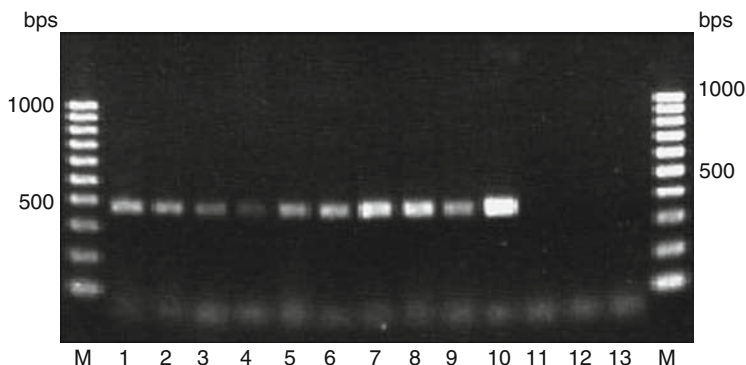
**Fig. 18.8** (a) Colonies of *O. gallopava* cultured on potato dextrose agar plate at 25, 37 and 42°C for 8 days, (b and c) clavate conidia under microscopy, x400



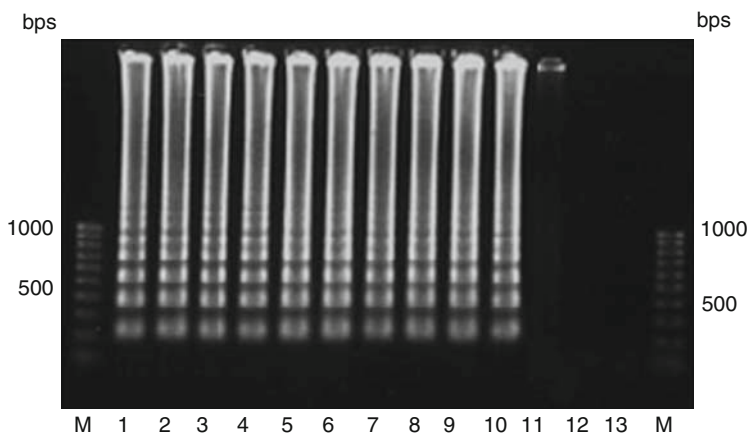
It affects the central nervous system and respiratory tracts of humans, birds and cats and is required to be differentiated from SARS and highly pathogenic bird flu. Clavate conidia (Fig. 18.8b and c) are virulent to experimentally infected mice (Ohuri et al. 2006; Yarita et al. 2007).

We designed *O. gallopava* species-specific primer sets to aid in its identification by the LAMP method based on the D1/D2 domain of the LSU rDNA sequence.

The primer set for *O. gallopava* was designed based on the sequence of D1/D2 LSU rDNA of *O. gallopava* (accession number AB125281 in GenBank) with a comparison of 21 species of dematiaceous fungi obtained from the present study and from 108 sequences in GenBank database. The primer sequences were as follows: OgF3: 5'-AGG GAG TCT CGG GTT AAG GG-3' encoding from the 391st to the 410th, and OgB3: 5'-CAT TCC CTT CGT CTT TGT CC-3' corresponding to the complementary sequence from the 718th to the 740th of AB125281 and were species-specific for *O. gallopava* (Fig. 18.9). FIP; 5'-ACT CGA CTC GTC GAA GGG GCA GAG GGT GAG AGT CCC GT-3' designed by the forward sequence of 425th to 445th and the complementary sequence of 464th to 485th, and BIP; 5'-ACT GGC CAG AGA CCG ATA GCG TGA CTC TCT TTT



**Fig. 18.9** Species specific PCR for *O. gallopava*. M: Marker, 1–10: *O. gallopava*, 11: *O. gamsii*, 12: and 13: *O. tsawtytschae*. The related species such as *O. constricta*, *O. humicola*, *Alternaria alternata*, *Arthrobotrys javanica*, *Bipolaris* sp., *Bipolaris specifera*, *Cladophialophora bantiana*, *C. carrionii*, *Curvularia geniculata*, *Cu. lunata* var. *lunata*, *Cu. senegalensis*, *Exophiala alcalophiala*, *E. dermatitidis*, *E. jeanselmei*, *E. moniliae*, *E. spinifera*, *Fonsecaea pedrosoi*, *Phialophora verrucosa*, *Rhinoctadiella atrovirens*, *Scolecobasidium terreum* were negative

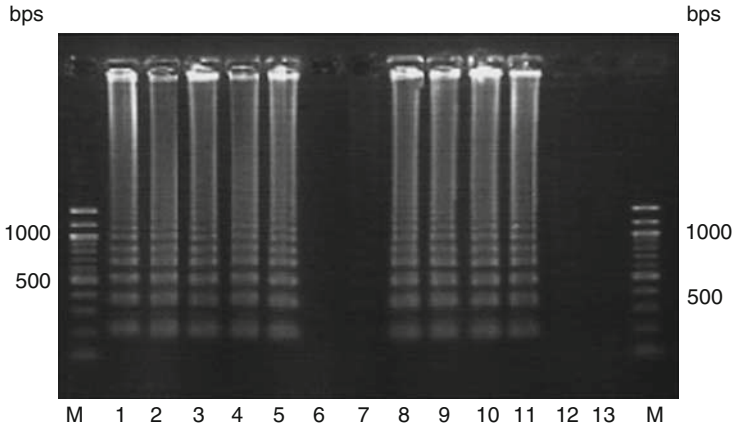


**Fig. 18.10** Species specific loop mediated isothermal amplification method (LAMP) for *O. gallopava*. M: Marker, 1–10: *O. gallopava*, 11: *O. gamsii*, 12: and 13: *O. tsawtytschae*. The related species such as *O. constricta*, *O. humicola*, *Alternaria alternata*, *Arthrobotrys javanica*, *Bipolaris* sp., *Bipolaris specifera*, *Cladophialophora bantiana*, *C. carrionii*, *Curvularia geniculata*, *Cu. lunata* var. *lunata*, *Cu. senegalensis*, *Exophiala alcalophiala*, *E. dermatitidis*, *E. jeanselmei*, *E. moniliae*, *E. spinifera*, *Fonsecaea pedrosoi*, *Phialophora verrucosa*, *Rhinoctadiella atrovirens*, *Scolecobasidium terreum* were negative

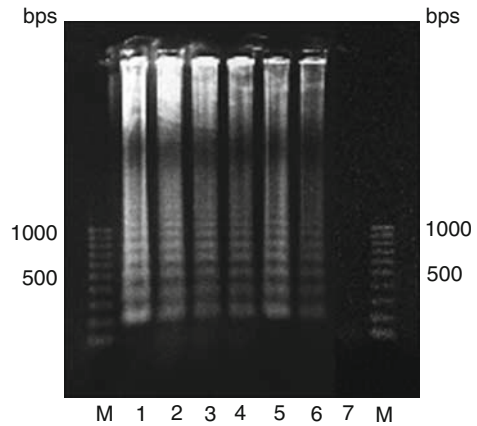
CAA AGT GC-3' designed by the forward sequence from 648th to 668th and the complementary sequence from 691 st to 712 nd of AB125281.

The LAMP method successfully detected the gene from both the fungal DNA derived from experimentally infected brains and spleens of mice and environmental





**Fig. 18.11** Detection of *O. gallopava* gene from the experimentally infected brains and spleens of mice by LAMP method. M: Marker, 1–5: brain tissue of mice infected with *O. gallopava*. 6: blank, 7–11: spleen tissue of mice infected with *O. gallopava*. 12 and 13: negative control DNA from demateaceous fungi



**Fig. 18.12** DNA pattern by loop mediated isothermal amplification method (LAMP) specific for *O. gallopava* using 20 pg of fungal DNA. M: Marker, 1 and 6: a clinical isolate, 2–5: hot spring isolates, 7: a negative control using distilled water for a template

isolates (Fig. 18.10–18.12), which will help to differentiate *O. gallopava* infection from other important avian zoonoses (Ohori et al. 2006; Yarita et al. 2007).

## 18.7 Conclusion and Future Line of Research

In conclusion, LAMP method for PCM and *O. gallopava* seemed to be useful for fungal identification, diagnosis or retrospective study with advantage in the quickness and simplicity procedure, but require strictly controlled environments. It could be applicable for clinical identification of fungi and diagnosis of fungal

diseases caused by level 3 biohazards, such as coccidioidomycosis, histoplasmosis, blastomycosis, and infection of *Penicillium marneffei*, which generally require care and time consuming culturing procedures, and causative agent for emerging fungal infections.

**Acknowledgments** We thank Drs. Kazuko Nishimura, Makoto Miyaji, Shigeo Endo, Akira Ohori, Tsuyoshi Igarashi, Koji Yokoyama, Masashi Yamaguchi, Yoko Takahashi, Katsuhiko Kamei, Marcello Franco, Giannina Ricci, Berenice Tatibana, Ms. Kyoko Yarita and Mr. Takashi Komori for their cooperation.

## References

- Almeida AJ, Matute DR, Carmona JA, Martins M, Torres I, McEwen JG, Restrepo A, Leão C, Ludovico P, Rodrigues F (2007) Genome size and ploidy of *Paracoccidioides brasiliensis* reveals a haploid DNA content: flow cytometry and GP43 sequence analysis. *Fungal Genet Biol* 44:25–31
- Bagagli E, Theodoro RC, Bosco SM, McEwen JG (2008) *Paracoccidioides brasiliensis*: phylogenetic and ecological aspects. *Mycopathol* 165:197–207
- Balajee SA, Sigler L, Brandt ME (2007) DNA and the classical way: identification of medically important molds in the 21st century. *Med Mycol* 45:475–490
- Borman AM, Linton CJ, Miles SJ, Johnson EM (2008) Molecular identification of pathogenic fungi. *J Antimicrob Chemother* 61(Suppl 1):i7–i12
- Brummer E, Castaneda E, Restrepo A (1993) Paracoccidioidomycosis: an update. *Clin Microbiol Rev* 6:89–117
- Camargo ZP (2008) Serology of paracoccidioidomycosis. A centennial: discovery of *Paracoccidioides brasiliensis*. *Mycopathol* 165:289–302
- Carrero LL, Niño-Vega G, Teixeira MM, Carvalho MJ, Soares CM, Pereira M, Jesuino RS, McEwen JG, Mendoza L, Taylor JW, Felipe MS, San-Blas G (2008) New *Paracoccidioides brasiliensis* isolate reveals unexpected genomic variability in this human pathogen. *Fungal Genet Biol* 45:605–612
- Christensson B, Sigmundsdottir G, Larsson L (1999) D-arabinitol—a marker for invasive candidiasis. *Med Mycol* 37:391–396
- Druzhinina IS (2005) An oligonucleotide barcode for species identification in *Trichoderma* and *Hypocrea*. *Fungal Genet Biol* 42:813–828
- Endo S, Komori T, Ricci G, Sano A, Yokoyama K, Ohori A, Kamei K, Franco M, Miyaji M, Nishimura K (2004) Detection of *gp43* of *Paracoccidioides brasiliensis* by the loop-mediated isothermal amplification (LAMP) method. *FEMS Microbiol Lett* 234:93–97
- Franco M (1987) Host-parasite relationships in paracoccidioidomycosis. *J Med Vet Mycol* 25:5–18
- Franco M, Sano A, Kera K, Nishimura K, Takeo K, Miyaji M (1989) Chlamyospore formation by *Paracoccidioides brasiliensis* mycelial form. *Rev Inst Med Trop Sao Paulo* 31:151–157
- Imai T, Sano A, Mikami Y, Watanabe K, Aoki FH, Branchini ML, Negrone R, Nishimura K, Miyaji M (2000) A new PCR primer for the identification of *Paracoccidioides brasiliensis* based on rRNA sequences coding the internal transcribed spacers (ITS) and 5.8S regions. *Med Mycol* 38:323–326
- Imai M, Ninomiya A, Minekawa H, Notomi T, Ishizaki T, Van Tu P, Tien NT, Tashiro M, Odagiri T (2007) Rapid diagnosis of H5N1 avian influenza virus infection by newly developed influenza H5 hemagglutinin gene-specific loop-mediated isothermal amplification method. *J Virol Methods* 141:173–180

- Inácio J, Flores O, Spencer-Martins I (2008) Efficient identification of clinically relevant *Candida* yeast species by use of an assay combining panfungal loop-mediated isothermal DNA amplification with hybridization to species-specific oligonucleotide probes. *J Clin Microbiol* 46:713–720
- Ishikawa H, Oda S, Murata A, Shimazaki S, Hirasawa H, Aikawa N (2008) Influence of the diagnosis and treatment guidelines for mycosis profunda (deep mycosis) in the field of emergency and critical care medicine—with reference to patient background. *Jpn J Antibiot* 61:18–28 (In Japanese)
- Itano E, Uno J, Sano A, Yarita K, Kamei K, Miyaji M, Nishimura K, Mikami Y (2002) 506 Detection of the gp43 gene and (1–3)-beta-D-glucan of *Paracoccidioides brasiliensis* in the 507 blood of experimentally infected mice. *Nippon Ishinkin Gakkai Zasshi* 43:29–35
- Iwamoto T, Sonobe T, Hayashi K (2003) Loop-mediated isothermal amplification for direct detection of *Mycobacterium tuberculosis* complex, *M. avium*, and *M. intracellulare* in sputum samples. *J Clin Microbiol* 41:2616–2622
- Kamei K, Sano A, Kikuchi K, Makimura K, Niimi M, Suzuki K, Uehara Y, Okabe N, Nishimura K, Miyaji M (2003) The trend of imported mycoses in Japan. *J Infect Chemother* 9:16–20
- Kelaher A (2006) Two non-invasive diagnostic tools for invasive aspergilosis: (1–3)-beta-D-glucan and the galactomannan assay. *Clin Lab Sci* 19:222–224
- Kobayashi T (2006) Strategies to maintain the stability of the ribosomal RNA gene repeats—collaboration of recombination, cohesion, and condensation. *Genes Genet Syst* 81:155–161
- Kwon-Chung KJ, Bennett JE (1992) In: Kwon-Chung KJ, Bennett JE (eds) *Medical mycology*. Pa: Lea & Febiger, Philadelphia, pp 594–619
- Larone DH (1995) Safety precautions. In: Larone DH (ed) *Medically important fungi*, 3rd edn. ASM press, Washington D.C., USA, pp 5–6
- Lucas S, da Luz Martins M, Flores O, Meyer W, Spencer-Martins I, Inácio J (2009) Differentiation of *Cryptococcus neoformans* varieties and *Cryptococcus gattii* using CAP59-based loop-mediated isothermal DNA amplification. *Clin Microbiol Infect* Aug 20. [Epub ahead of print]
- Matute DR, McEwen JG, Puccia R, Montes BA, San-Blas G, Bagagli E, Rauscher JT, Restrepo A, Morais F, Niño-Vega G, Taylor JW (2006a) Cryptic speciation and recombination in the fungus *Paracoccidioides brasiliensis* as revealed by gene genealogies. *Mol Biol Evol* 23:65–73
- Matute DR, Sepulveda VE, Quesada LM, Goldman GH, Taylor JW, Restrepo A, McEwen JG (2006b) Microsatellite analysis of three phylogenetic species of *Paracoccidioides brasiliensis*. *J Clin Microbiol* 44:2153–2157
- Matute DR, Torres IP, Salgado-Salazar C, Restrepo A, McEwen JG (2007) Background selection at the chitin synthase II (chs2) locus in *Paracoccidioides brasiliensis* species complex. *Fungal Genet Biol* 44:357–367
- Miura CS, Estevão D, Lopes JD, Itano EN (2001) Levels of specific antigen (gp43), specific antibodies and antigen-antibody complexes in saliva and serum of paracoccidioidomycosis patients. *Med Mycol* 39:423–428
- Motoyama AB, Venancio EJ, Brandão GO, Petrofeza-Silva S, Pereira IS, Soares CM, Felipe MS (2000) Molecular identification of *Paracoccidioides brasiliensis* by PCR amplification of ribosomal DNA. *J Clin Microbiol* 38:3106–3109
- Nagamine K, Hase T, Notomi T (2002) Accelerated reaction by loop-mediated isothermal amplification using loop primers. *Mol Cell Probes* 16:223–229
- Notomi T, Okayama H, Masubuchi H, Yonekawa T, Watanabe K, Amino N, Hase T (2000) Loop-mediated isothermal amplification of DNA. *Nucleic Acids Res* 28:E63–e63
- Ohuri A, Endo S, Sano A, Yokoyama K, Yarita K, Yamaguchi M, Kamei K, Miyaji M, Nishimura K (2006) Rapid identification of *Ochroconis gallopava* by a loop-mediated isothermal amplification (LAMP) method. *Vet Microbiol* 114:359–365
- Ono MA, Kishima MO, Itano EN, Bracarense AP, Camargo ZP (2003) Experimental paracoccidioidomycosis in dogs. *Med Mycol* 41:265–268
- Puccia R, McEwen JG, Cisalpino PS (2008) Diversity in *Paracoccidioides brasiliensis*. The Pb GP43 gene as a genetic marker. A centennial: discovery of *Paracoccidioides brasiliensis*. *Mycopathol* 165:275–287

- Reiss E, Obayashi T, Orle K, Yoshida M, Zancopé-Oliveira RM (2000) Non-culture based diagnostic tests for mycotic infections. *Med Mycol* 38(Suppl 1):147–159
- Restrepo AM (1985) The ecology of *Paracoccidioides brasiliensis*: a puzzle still unsolved. *J Med Vet Mycol* 23:323–334
- Ricci G, Mota FT, Wakamatsu A, Serafim RC, Borra RC, Franco M (2004) Canine paracoccidioidomycosis. *Med Mycol* 42:379–383
- Sano A, Defaveri J, Tanaka R, Yokoyama K, Kurita N, Franco M, Coelho KI, Bagagli E, Montenegro MR, Miyaji M, Nishimura K (1998–1999) Pathogenicities and GP43kDa gene of three *Paracoccidioides brasiliensis* isolates originated from a nine-banded armadillo (*Dasypus novemcinctus*). *Mycopathology* 144:61–65
- Sano A, Yokoyama K, Tamura M, Mikami Y, Takahashi I, Fukushima K, Miyaji M, Nishimura K (2001) Detection of gp43 and ITS1–5.8S-ITS2 ribosomal RNA genes of *Paracoccidioides brasiliensis* in paraffin-embedded tissue. *Nippon Ishinkin Gakkai Zasshi* 42:23–27
- Sano A, Miyaji M, Kamei K, Mikami Y, Nishimura K (2006) Reexamination of *Coccidioides* spp. reserved in the Research Center for Pathogenic Fungi and Microbial Toxicoses, Chiba University, based on a multiple gene analysis. *Nippon Ishinkin Gakkai Zasshi* 47:113–117
- Takayama A, Itano EN, Sano A, Ono MA, Kamei K (2009) An atypical *Paracoccidioides brasiliensis* clinical isolate based on multiple gene analysis. *Med Mycol* 2009 Feb 19:1–9 [Epub ahead of print]
- Tatibana BT, Sano A, Uno J, Kamei K, Igarashi T, Mikami Y, Miyaji M, Nishimura K, Itano EN (2009) Detection of *Paracoccidioides brasiliensis* gp43 gene in sputa by loop-mediated isothermal amplification method. *J Clin Lab Anal* 23:139–143
- Teixeira MM, Theodoro RC, de Carvalho MJ, Fernandes L, Paes HC, Hahn RC, Mendoza L, Bagagli E, San-Blas G, Felipe MS (2009) Phylogenetic analysis reveals a high level of speciation in the *Paracoccidioides* genus. *Mol Phylogenet Evol* 52:273–283
- Umeyama T, Sano A, Kamei K, Niimi M, Nishimura K, Uehara Y (2006) Novel approach to designing primers for identification and distinction of the human pathogenic fungi *Coccidioides immitis* and *Coccidioides posadasii* by PCR amplification. *J Clin Microbiol* 44:1859–1862
- Uno J, Tanaka R, Branchini ML, Aoki FH, Yarita K, Sano A, Fukushima K, Mikami Y, Nishimura K, Miyaji M (2001) Atypical *Cryptococcus neoformans* isolate from an HIV-infected patient in Brazil. *Nippon Ishinkin Gakkai Zasshi* 42:127–132
- Nagamine K, Watanabe K (2001) Loop-mediated isothermal amplification reaction using a non-denatured template. *Clin Chem* 47:1742–1743
- Yarita K, Sano A, Murata Y, Takayama A, Takahashi Y, Takahashi H, Yaguchi T, Ohori A, Kamei K, Miyaji M, Nishimura K (2007) Pathogenicity of *Ochroconis gallopava* isolated from hot springs in Japan and a review of published reports. *Mycopathology* 164:135–147

# Chapter 19

## Identification of the Genus *Absidia* (Mucorales, Zygomycetes): A Comprehensive Taxonomic Revision

Kerstin Hoffmann

**Abstract** This brief review intends to survey and evaluate the present knowledge about the genus *Absidia* Tiegh. sensu lato regarding the traditional and current position within the order Mucorales (Mucoromycotina, Zygomycetes), nomenclatural changes and the taxonomical rearrangements of the prevalent species. Species grouped within *Absidia* possess some very promising industrial and medical application possibilities e.g., as mediators of biotransformations, producers of antimicrobial and wound healing stimulators. But some species are also causatives of severe and frequent fatal mucormycoses. Using traditional and modern methods of species determination had uncovered a trichotomous genera separation, namely *Absidia* sensu stricto, *Lichtheimia*, and *Lentamyces*, belonging to distinct families, the Absidiaceae, Lichtheimiaceae and “Lentamycetaceae” (NN), respectively. The existing medical and industrial aspects necessitate a fast and secure identification of a prominent species. Within this survey, morphological criteria and molecular markers were proposed for clear distinction of *Absidia* sensu lato.

### 19.1 The Genus *Absidia*: Current State of the Art – A Brief Survey

The order Mucorales within the proposed subphylum Mucoromycotina (Hibbett et al. 2007) comprises ubiquitous soil fungi mainly living as saprobes, but also facultative parasites on other fungi or plants and opportunistic pathogens causing mucormycoses in human and animals (Ribes et al. 2000; Thirion-Delalande et al. 2005). One of these causative organisms is the genus *Absidia* causing rhino-cerebral

---

K. Hoffmann

Institute of Microbiology, School of Biology and Pharmacy, University of Jena, Neugasse, 25, 07743 Jena, Germany

e-mail: Hoffmann.Kerstin@uni-jena.de

mycoses, primary cutaneous, pulmonary or gastrointestinal lesions which occur sometimes in humans showing debilitating conditions like diabetes, burn wounds, immunosuppression, or traumata (Gonzalez et al. 2002; Ribes et al. 2000). Since opportunism of *Absidia* species is pronounced by growth maxima above body temperature, thermotolerant species enjoy physiological advantages over mesophilic ones. Not only due to its opportunism is the genus *Absidia* of recurrent interest but also due to some interesting biotechnological applications. For instance, microbial biotransformations are an important tool for pharmaceutical, economical purposes or even biodegradation of environmental pollutants (Chen et al. 2007; Demirci et al. 2004; Guiraud et al. 2008).

To describe and classify species of the genus *Absidia* was therefore the main objective of several mycologists and taxonomists. The genus was described in 1876 by van Tieghem and augmented by reputable taxonomists like Bainier (1882, 1889), Hagem (1908), and Lendner (1907, 1908, 1924). Comprehensive morphological and physiological investigations of *Absidia* species were accomplished especially by Hesseltine, Ellis and Schipper (Hesseltine and Ellis 1961, 1964, 1966; Ellis and Hesseltine 1965, 1966; Schipper 1990). Molecular aspects have led to a renewal of species differentiation and were included in recent years, allowing for a reliable discrimination at species and genus level. Combined with differences in growth temperature as well as morphological distinctions, the genus *Absidia* was previously distinguished in *Absidia sensu stricto* encompassing the mesophilic species and in *Lichtheimia* comprising the thermotolerant species, which were summarized into a distinct family, the Mycocladaceae (orthographically erroneously pronounced as “Mycocladiaceae,” Hoffmann et al. 2007) and revised in the Lichtheimiaceae (Hoffmann et al. 2009b). For potential mycoparasitic species, a third genus, *Lentamyces*, was erected (Hoffmann and Voigt 2008). A detailed chronological summary of important accepted species and genera is given in Table 19.1 with family affiliation, type strain specification and MycoBank number ([www.mycobank.org](http://www.mycobank.org); Crous et al. 2004; Robert et al. 2005).

## 19.2 The Traditional Genus *Absidia*: Morphological Aspects

Nomenclatural designation of *Absidia* (Etym.: *absis*, arcus) started as early as 1876 with the genus description by van Tieghem. He characterized this genus by (1) arcuated stolons with rhizoids, (2) rhizoids not opposite the sporangiophores, (3) sporangiophores arising from the elevated parts of the stolons, (4) apophysate and pyriform sporangia with deliquescent walls, and (5) zygospores surrounded by appendages originating from the suspensors (van Tieghem 1876).

The assignment of species to the genus *Absidia sensu lato* is mainly based on traditional morphological criteria and growth parameters. In so doing, the last species identified so far is a thermotolerant variety of *A. idahoensis* (*A. idahoensis* var. *thermophila*, Chen and Zheng 1998).

**Table 19.1** Major species traditionally placed within *Absidia* sensu lato and currently accepted within the genera *Absidia* sensu stricto, *Lichtheimia*, and *Lentamyces*

Year	Species	Type strain	Mycobank no.
<i>Absidia</i> TIEGH. 1876, MB20001, type species: <i>A. repens</i> TIEGH., family Absidiaceae MB81973			
1876	<i>A. repens</i> TIEGH.	CBS115583 (IT)	MB223578
1889	<i>A. caerulea</i> BAINIER	NRRL1315 (NT)	MB351936
1907	<i>A. spinosa</i> var. <i>spinosa</i> LENDN.	NRRL2797 (T)	MB224063
1908	<i>A. cylindrospora</i> HAGEM var. <i>cylindrospora</i>	NRRL1317 (T)	MB427391
1908	<i>A. glauca</i> HAGEM	NRRL1328 (T)	MB221208
1930	<i>A. heterospora</i> Y. LING	NRRL2800 (T)	MB252572
1936	<i>A. fusca</i> LINNEM.	NRRL2793 (T)	MB252285
1958	<i>A. spinosa</i> var. <i>azygospora</i> BOEDIJN	NRRL2841 (T)	MB346488
1959	<i>A. cuneospora</i> G.F. ORR & PLUNKETT	NRRL2632 (T)	MB292052
1961	<i>A. cylindrospora</i> var. <i>rhizomorpha</i> HESSELT. & J.J. ELLIS	NRRL2771 (T)	MB348992
1962	<i>A. pseudocylindrospora</i> HESSELT. & J.J. ELLIS	NRRL2770 (T)	MB325715
1964	<i>A. anomala</i> HESSELT. & J.J. ELLIS	NRRL1807 (T)	MB325709
1964	<i>A. cylindrospora</i> var. <i>nigra</i> HESSELT. & J.J. ELLIS	NRRL3060 (T)	MB353238
1964	<i>A. spinosa</i> var. <i>biappendiculata</i> RALL & SOLHEIM	NRRL3033 (T)	MB348993
1965	<i>A. californica</i> J.J. ELLIS & HESSELT.	NRRL2968 (T)	MB325710
1968	<i>A. macrospora</i> VÁNOVÁ	CBS697.68 (T)	MB325712
<i>Lichtheimia</i> VUILL. 1903, MB20308, type species: <i>L. corymbifera</i> (COHN) VUILL., family Lichtheimiaceae MB508680			
1903	<i>L. corymbifera</i> (COHN 1884) VUILL.	NRRL2981 (NT)	MB416447
1903	<i>L. ramosa</i> (ZOPF 1890) VUILL.	NRRL1309 (NT)	MB416448
2009	<i>L. hyalospora</i> (SAITO 1906) K. HOFFM, G. WALTHER & K. VOIGT	NRRL2916 (NT)	MB512830
2009	<i>L. ornata</i> (A.K. Sarbhoy 1965) A. ALASTRUEY-IZQUIERDO & G. WALTHER	NRRL10293 (IT)	–
2010	<i>L. sphaerocystis</i> A. ALASTRUEY-IZQUIERDO & G. WALTHER	CBS420.70 (T)	–
<i>Lentamyces</i> K. HOFFM. & K. VOIGT 2008, MB511979, type species: <i>L. parricida</i> (RENNER & MUSKAT ex HESSELT. & J.J. ELLIS) K. HOFFM. & K. VOIGT			
2008	<i>L. parricida</i> (RENNER & MUSKAT ex HESSELT. & J.J. ELLIS 1964) K. HOFFM. & K. VOIGT	NRRL2409 (T)	MB511980
2008	<i>L. zychae</i> (HESSELT. & J.J. ELLIS 1966) K. HOFFM. & K. VOIGT	NRRL2806 (T)	MB511981

NT Neotype; IT Isotype; T type; NRRL Northern Regional Research Laboratories, strain collection of the National Center of Agricultural Utilization Research Peoria, IL, USA; CBS Centraalbureau voor Schimmelcultures Utrecht, The Netherlands

Although the first species described possess appendaged suspensors of their zygospores, several species lacking appendages were described in the following years, and due to further differences in morphology and physiology (especially sporangiophore branching, stolon, rhizoid and zygospore appearance, as well as growth temperature) ten different generic names were proposed over the years 1888–2008 in order to delimitate *Absidia*-like species from unequivocal designation to *Absidia*: *Tieghemella* BERL. & DE TONI (1888), *Mycocladus* BEAUVERIE (1900), *Proabsidia* VUILL (1903), *Lichtheimia* VUILL (1903), *Pseudoabsidia* [as “*Pseudo-Absidia*”] BAINIER (1903), *Protoabsidia* NAUMOV (1935), *Gongronella* RIBALDI (1952), *Chlamydoabsidia* HESSELT. & J.J. ELLIS (1966), *Siepmannia* KWAŚNA & NIRENBERG (2008a, b) and *Lentamyces* K. HOFFM. & K. VOIGT (2008).

The genera *Absidia*, *Tieghemella*, and *Proabsidia* are now considered as synonyms for species with zygospores surrounded by appendages from the suspensors whereas, *Lichtheimia*, *Mycocladius*, *Pseudoabsidia*, and *Protoabsidia* were assigned to *Absidia* species lacking such appendages (Hesseltine and Ellis 1964; Schipper 1990).

The genus *Gongronella*, which is based on *Absidia butleri* LENDN., shows an apophysis, nonpyriform sporangia with reduced columellae, and zygospore suspensors devoid of appendages (Ribaldi 1952).

Based on morphology, the genus *Chlamydoabsidia* is obviously nested within *Absidia* sensu stricto but developing unique multiseptate, pigmented aerial chlamydospores (Hesseltine and Ellis 1966). Most recently the species with warty exospore of their *Mucor*-like zygospores were separated in the genus *Lentamyces*, which was first invalidly (then correctly) described as *Siepmannia* the same year (Hoffmann and Voigt 2008; Kwaśna and Nirenberg 2008a, b).

### 19.3 The Impact of Molecular Data: The Genus *Absidia* sensu lato is Distinguished in at Least Three Nonrelated Genera

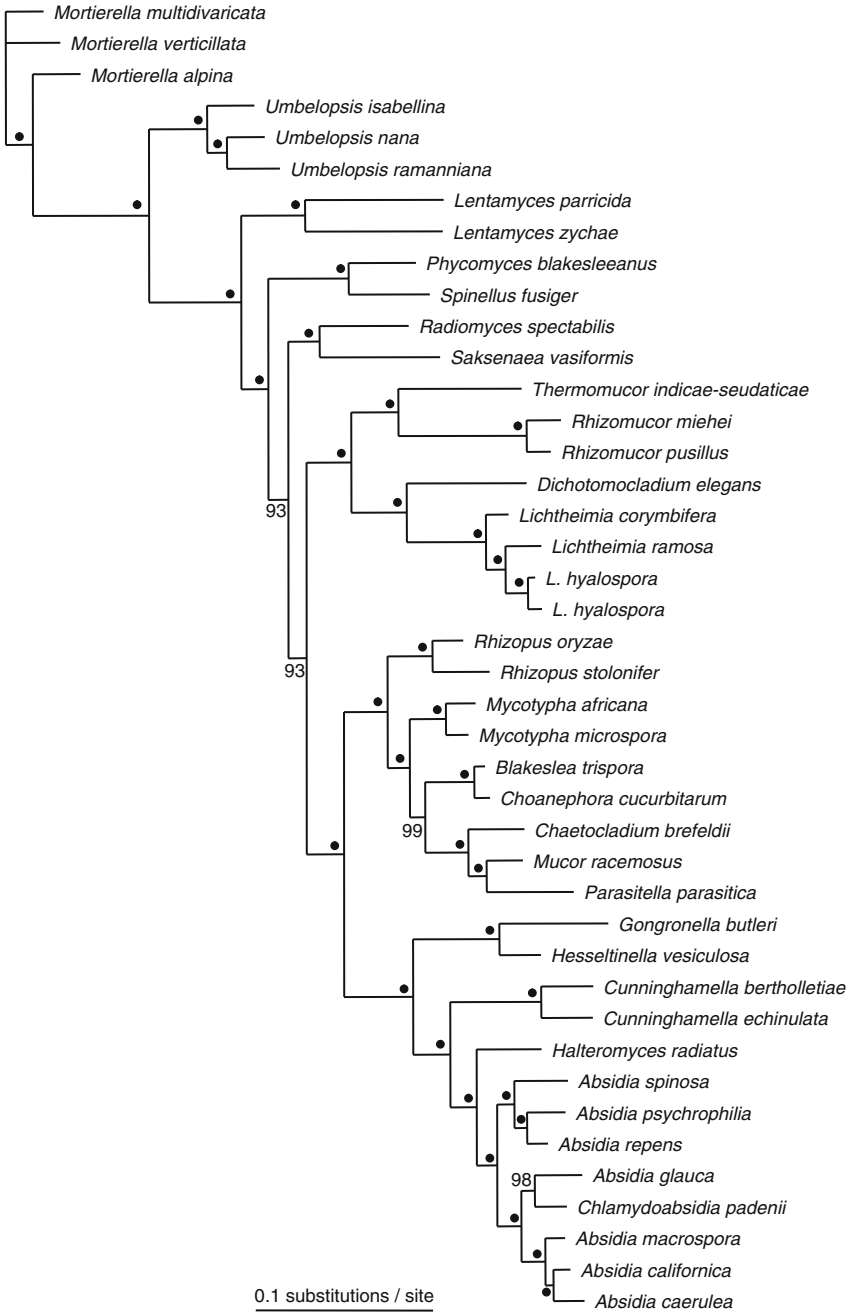
Support of its morphological and physiological evidence by molecular based phylogenetic analyzes has led to a wide acceptance of the polyphyly of *Absidia* in recent years (Voigt et al. 1999; Voigt and Wöstemeyer 2001; O'Donnell et al. 2001; Kwaśna et al. 2006). This phylogenetic interpretation approximates a natural system contradicting the nomenclatural inflation of *Absidia* and its allied genera around the turn of the nineteenth century.

In order to prove and support the relationship of the described species to a specific genus within this study, molecular data was analyzed in a multigene phylogeny and supplemented with morphological and physiological data (here especially parameters of growth temperature). An alignment of the combined ribosomal DNA sequences (18S rDNA, 28S rDNA) and nucleotide sequences coding for actin (*act*) and translation elongation factor 1 alpha (*tef*) was subjected to a Bayesian inference (Fig. 19.1).

Since their morphology-based description, the genera *Gongronella* and *Chlamydoabsidia* are considered as independent *Absidia*-like genera, but they are still somehow related to *Absidia* morphologically and also on the molecular level, with *Chlamydoabsidia* nested within the genus and *Gongronella* closely related to the *Absidia* core group (Voigt et al. 1999; O'Donnell et al. 2001; Voigt and Wöstemeyer 2001; Hoffmann and Voigt 2008; Fig. 19.1).

The classification currently accepted assigns *Absidia*-like taxa to three different genera and is supported by molecular phylogenies, morphological and physiological studies: (1) *Absidia* sensu stricto (syn. *Tieghemella*, *Proabsidia*), (2) *Lentamyces* and (3) *Lichtheimia* (syn. *Mycocladius*, *Pseudoabsidia*, *Protoabsidia*).





**Fig. 19.1** Phylogeny of inferred by Bayesian analysis from a combined analysis of aligned nucleotide sequences coding for actin, translation elongation factor 1alpha, small (18S) and large (28S) subunit rRNA (see Table 19.3). Posterior Probabilities (PP) are given above the branches with dots indicating 100%

### 19.3.1 *The Genus Absidia TIEGH. sensu stricto Deserves a Separate Family, the Absidiaceae v. ARX*

As already mentioned, the genus *Absidia* sensu stricto harbors mesophilic species with the optimum and maximum temperatures for growth around 30°C and 37°C respectively. Along with their common pyriform, multispored sporangia, they form columellae with species specific apical projections (Hoffmann et al. 2007). Furthermore, the asexually produced sporangiospores are species-specifically globose to cylindrical. As outlined in detail by Schipper (1990), *Absidia* could be divided into several groups distinguishable by their spores. This distinction is of taxonomical importance, since it is also present in molecular phylogenetic analyzes. (Kwaśna et al. 2006; Hoffmann et al. 2007, 2009a; Hoffmann and Voigt 2008). Within these analyzes three well supported clades are obvious: *A. caerulea*, *A. californica*, *A. glauca*, and *A. macrospora* with globose sporangiospores (temperature for growth and sporulation at 15–30°C, no growth at 34–37°C). *A. anomala*, *A. cylindrospora*, *A. pseudocylindrospora*, *A. psychrophilia*, *A. repens*, and *A. spinosa* possess oval to cylindrical spores (growth and sporulation at 15–34°C, no growth at 30–37°C), and *A. cuneospora* shows conical shaped spores and represents an intermediate species positioned between the other two groups (Schipper 1990; Hoffmann et al. 2007; missing data for *A. cuneospora* in Fig. 19.1).

Species within these clades, especially *A. caerulea* and *A. glauca*, offer some pharmaceutical important properties as biomimetic models to test the metabolism of xenobiotics like steroids and saponins in mammalia (Brezewska et al. 1996; Huszcza and Dmochowska-Gladysz 2003; Chen et al. 2007). Both species are also potentially chitosan producers, useable in the food processing industry as well as medical applications since chitosan seems to possess antimicrobial and wound-healing stimulating activities (Abdel-Fattah et al. 1984; Muzzarelli et al. 1994; Rungardthong et al. 2006; Dai et al. 2009). Some species were also extensively studied for applications in environmental detoxifications like *A. cylindrospora* and *A. fusca*, which are able to degrade polycyclic aromatic hydrocarbons (Guiraud et al. 2008).

All species belonging to the genus *Absidia* sensu stricto could now be summarized in the family Absidiaceae, which was erected by von Arx (1982). Although von Arx included fourteen genera within the Absidiaceae, only six are accepted here, namely *Absidia*, *Chlamydoabsidia*, *Cunninghamella*, *Gongronella*, *Halteromyces*, and *Hesseltinella*. Even though, there are only a few studies including all affected genera in one analysis, the close relationships between some of these genera was repeatedly demonstrated. Based on 18S and 28S rDNA sequences, *Absidia*, *Chlamydoabsidia* and *Cunninghamella* are well supported sister taxa (100% BS, Voigt et al. 1999). Based on the combined coding sequences of *act* and *tef*, *Absidia*, *Chlamydoabsidia*, *Cunninghamella*, *Hesseltinella* and *Halteromyces* are in close vicinity (without high support values, Voigt and Wöstemeyer 2001) but high support values for this clade (additionally including *Gongronella*, 100% BS) are presented by O'Donnell et al. 2001, in an analysis of combined *tef* and rDNA

sequences. Except of *Chlamydoabsidia* (which is always nested within *Absidia*), all genera are slightly distinct from the core *Absidia*, but are related within one monophyletic clade (Fig. 19.1, 100% posterior probability (PP)). On the morphological level, the main distinctions could be found in the shape of the sporangia (e.g., pyriform for *Absidia*, dumbbell-shaped for *Halteromyces*), number of spores produced within each sporangia (e.g., few or uni-spored [*Cunninghamella*] or multispored [*Halteromyces*, *Absidia*]), and zygospore appearance (with [*Absidia*] or without appendages on the suspensors [*Cunninghamella*, *Gongronella*]). All of these characteristics seem not to be systematically important in family description, a finding which was also proven for other families within the order Mucorales (Voigt et al. 2009), and in the past, these morphological criteria have led to systematic classifications, not sustainable in the era of molecular phylogenetics (e.g., Absidiaceae comprised fourteen genera from which only six are phylogenetically related; compare von Arx 1982 and O'Donnell et al. 2001; Voigt and Wöstemeyer 2001). Although Absidiaceae is treated as a synonym of the highly polyphyletic family Mucoraceae (Kirk et al. 2008), in accordance to Voigt et al. (2009) a restoration of the monophyletic Absidiaceae is highly recommended here.

### 19.3.2 *The Genus Lichtheimia (COHN) VUILL. and Its Family Lichtheimiaceae K. HOFFM., G. WALTHER and K. VOIGT*

*Lichtheimia corymbifera* (formerly: *Absidia corymbifera*) is a common causative agent of mucormycoses and was described as *Mucor corymbifer* by Cohn 1884. Mycoses caused by other species belonging to this genus were not reported yet, which is, in all likelihood, a problem of proper identification as well as taxonomical knowledge. Morphological and physiological separation between the species of *Lichtheimia* depends on differences in the growth temperature, in the giant cell and partly in the sporangiospore morphology (Hoffmann et al. 2007, 2009a; Alastruey-Izquierdo et al. 2010), and with optima for growth around 37°C all species should be capable to colonize endothermic organisms under appropriate conditions. With the growing awareness for the need to differentiate between single species in fungal infections, it was essential to discriminate *Lichtheimia* from *Absidia* species, because species of the mesophilic genus *Absidia* are known to be harmless and do not cause systemic infections in human and warm-blooded animals. Furthermore, the assignment of all known former thermotolerant *Absidia* species to the genus *Lichtheimia* is essential for the establishment of a natural monophylum-based system.

*Lichtheimia* is distinguished from *Absidia* not only on the molecular level, but also on the basis of morphological and growth-physiological differences. Since comprehensive analyses including as many genera as possible, thermotolerant species were clearly distinct from mesophilic *Absidia* species (Voigt et al. 1999, 2009; O'Donnell et al. 2001; Voigt and Wöstemeyer 2001; Hoffmann et al. 2007; Hoffmann and Voigt 2008). Due to zygospores lacking appendaged suspensors and growth temperatures with optima and maxima above 37°C, a separation of these

species within the subgenus *Mycocladus* was proposed by Hesseltine and Ellis (1964) and was accepted by Schipper (1990). This subgenus was based on the type taxon *M. verticillatus* BEAUVÉRIE (Beauverie 1900). *Mycocladus* was also described as independent genus (Mirza et al. 1979; Vánová 1991). Based on physiological, phylogenetic and morphological analyses the (sub-)genus *Mycocladus* was reclassified in the new family Mycocladaceae [as “Mycocladiaceae”], K. HOFFM., DISCHER & K. VOIGT emphasizing its phylogenetic distinctness from species designated to *Absidia* (Hoffmann et al. 2007). But in the course of a critical reexamination of all available literature references, especially the years around the turn of the century (1882–1904), the correct assignment of *Mycocladus verticillatus* as type taxon for nonappendaged zygosporous suspensors was rejected. Furthermore, on the morphological level *Mycocladus verticillatus* seems to be a coculture of at least two different species (Beauverie 1900; Hoffmann et al. 2009b).

The first rough-walled zygosporous spores with unadorned suspensors and equatorial ridges within the genus *Absidia* were described in 1903 by Bainier for the species *Pseudoabsidia vulgaris* [as “*Pseudo-Absidia*”], based on *Absidia dubia* BAINIER 1882 (Bainier 1882, 1903). His error of assigning a wrong epithet was corrected the same year by Sydow, proposing *Pseudabsidia dubia* (BAINIER) SYDOW (Sydow 1903). The species was later transferred to *Lichtheimia*, a genus named in honor of the mycologist Lichtheim, professor at the University of Bern, Switzerland (Vuillemin 1903, 1904). Within the same publication issue of the *Bulletin de Société Mycologique de France* where Bainier described *Pseudoabsidia* (page 155), Vuillemin proposed the genus *Lichtheimia* (page 126). He recognized *Mucor corymbifer* COHN as type of *Lichtheimia*. The appearance of nonappendaged and naked zygosporous in *L. corymbifera* was described separately (Vuillemin 1904).

The original description of *Lichtheimia* VUILL. and its type *L. corymbifera* represents the new family Lichtheimiaceae K. HOFFM., G. WALTHER & K. VOIGT which harbors the species *L. corymbifera* (COHN) VUILL., *L. ramosa* (ZOPF) VUILL., *L. ornata* (A.K. SARBHOY) A. ALASTRUÉY-IZQUIERDO & G. WALTHER, *L. hyalospora* (SAITO) K. HOFFM., WALTHER & K. VOIGT and *L. sphaerocystis* A. ALASTRUÉY-IZQUIERDO & G. WALTHER.

### 19.3.3 *The Genus Lentamyces and a Required Excursus to Siepmannia: Species Boundaries*

The genus *Lentamyces* K. HOFFM. & K. VOIGT comprises homothallic and potentially mycoparasitic species producing warty zygosporous lacking appendaged suspensors (Hoffmann and Voigt 2008). This genus is composed of currently two species with the potentially mycoparasitic *L. zychae* and the mycoparasitic *L. parricida*. *L. zychae* was originally described to be mycoparasitic on other Mucorales (Zycha 1935), but could never be confirmed as causative agent of mycoparasitic reactions on other mucoralean hosts in recent confrontation experiments using the type strain NRRL2806 (Table 19.1; Hoffmann and Voigt 2008). But for *L. parricida* a wide

variety of potential mucoralean hosts are experimentally confirmed (Schipper 1990; Hoffmann and Voigt 2008). Apart from the varying potential for mycoparasitic abilities, both species show morphological and physiological characteristics of mycoparasitic fungi such as slowly developing colonies with thin mycelia, and abundant sucker-like branches in the substrate mycelium of single cultures but vigorously growing hyphae in cocultures with other mucoralean fungi. *L. zychae* and *L. parricida* form a monophyletic group (100% PP) which is closely related to the Phycomycetaceae (Voigt et al. 2009). The *Lentamyces* clade may represent the next to the last family, the putative “Lentamyetaceae,” at the base of the order Mucorales (Fig. 19.1). Their homothallic and facultative parasitic nature turns this basal lineage of mucoralean fungi into an interesting subject to study the evolution of fungal communication directly at the level of radiation and diversification of mucoralean fungi (Hoffmann et al. 2007; Hoffmann and Voigt 2008). In 2008 both species were classified into the genus *Siepmannia* as *S. parricida* and *S. zychae*. The genus was amended by two new species, *S. pineti* and *S. lariceti*. The authors described *S. pineti* as morphologically similar to *Fennellomyces linderi* and *S. lariceti* similar to *Mucor circinelloides* but with micromorphological features of different size (Kwaśna and Nirenberg 2008a). Nevertheless, judging by the presented descriptions and photographs, *S. pineti* seems more like a species of the genus *Circinella*: developing structures typical for *Circinella* like circinate sporangiophores terminating in globose to dorsiventrally flattened sporangia with a persistent wall. *F. linderi* would occasionally develop a subsporangial vesicle, not described for *Siepmannia*. *S. lariceti* seems with all likelihood representing a species of *Mucor*, as stated by Kwaśna and Nirenberg. On the contrary, neither *L. parricida* nor *L. zychae* produce circinate nor sympodially branched sporangiophores as described for *Siepmannia*. The sporangia are always globose to subpyriform, apophysate surrounded with a deliquescent sporangial wall (Hesseltine and Ellis 1964, 1966).

Although species of *Siepmannia* are described to be mycotrophic, no hint for potential mycoparasitism was reported (Kwaśna and Nirenberg 2008a). Parasitic interactions, e.g., between *L. parricida* and one of its host *Zygorhynchus moelleri*, was successfully demonstrated by Hoffmann and Voigt 2008. A typical morphological feature of *Lentamyces* is the abundant sucker-like substrate mycelium and the homothallic formed globose zygosporangia with a warty exospore. No such typical mycelium was pictured for *S. lariceti* and *S. pineti*. The zygosporangia of *S. lariceti* are globose to ellipsoid and not as large and warty as those of *Lentamyces*. The only criteria which have *Siepmannia* and *Lentamyces* in common are of physiological nature, e.g., a low maximum temperature for growth and a restricted growth, which is stimulated in the presence of other fungi (potential hosts in the case of *Lentamyces*) (Kwaśna and Nirenberg 2008a; Hesseltine and Ellis 1964, 1966; Hoffmann and Voigt 2008). However, physiological criteria may vary among isolates and species and their relevance as synapomorphic characters is limited (Voigt et al. 2009).

In a further step, the authors generated species-specific restriction patterns of digested ITS sequences. They used the enzymes *AluI*, *HhaI*, *DdeI*, *HaeIII*, *HincII*, *HinfI*, *HpaII*, *Sau3AI*, and *TaqI*, which clearly differentiated *S. pineti*

from *S. lariceti* and *F. linderi* as well as *S. lariceti* from *M. circinelloides* (Kwaśna and Nirenberg 2008a) Nevertheless, they did not say anything about the restriction patterns of *L. parvicida* and *L. zychae*. Repeating these restriction experiments with all species of *Lentamyces* and *Siepmannia* in theoretical in silico RFLP analyses using BioEdit v.7.0.9.0 (Hall 1999) resulted in highly variable restriction fragment length polymorphisms among the strains (Table 19.2). Neither *Siepmannia* nor *Lentamyces* show similar restriction sites to each other or to *Mucor circinelloides* or *Fennellomyces linderi*. Based on the present characteristics, it could not be stated whether *Lentamyces* and *Siepmannia* share a common generic designation or represent distinct taxa.

The molecular phylogenetic analysis presented by Kwaśna and Nirenberg (2008a) was done on ITS1-5.8S rDNA-ITS2 sequences and lacks reference and type species. The fusion of both genera within *Siepmannia* neglects obvious morphological and molecular distinctions and does not doubtlessly justify a combination of the genus *Siepmannia* with *L. zychae* and *L. parvicida*. The relationship between *Siepmannia* and *Lentamyces* has to be proven by further investigations

**Table 19.2** Theoretical *in silico* RFLP analyses of species belonging to the genera *Lentamyces* and *Siepmannia* as well as *Mucor circinelloides* and *Fennellomyces linderi*. Bold indicated restriction sites are similar in *Siepmannia* but are not present in *Lentamyces*, *M. circinelloides* or *F. linderi*

Species and GenBank accession number	Length of ITS1- 5.8S-ITS2 [bp]	Restriction sites for different enzymes								
		<i>AluI</i>	<i>HhaI</i>	<i>DdeI</i>	<i>HaeIII</i>	<i>HincII</i>	<i>HinfI</i>	<i>HpaII</i>	<i>Sau3AI</i>	<i>TaqI</i>
<i>S. pineti</i> AJ748134	630	241	–	–	473	–	339	151	25	168
		249					347	381	272	291
<i>S. lariceti</i> AJ748857	402; first 178 bp are missing	547	–	–	466	–	340	–	272	291
							348			
<i>L. parvicida</i> AY944884	545	–	–	–	406	–	267	309	198	90
							275	472		100
<i>L. zychae</i> EF030529	594	444	–	–	–	–	10	331	222	119
							289	512		241
<i>L. zychae</i> AJ968561	594	444	–	–	422	–	10	331	222	119
							289	343		241
<i>M. circinelloides</i> AJ878535	556	129	337	78	147	122	308		237	256
				142	457		316			314
<i>F. linderi</i> AJ878536	669	467			533		354		283	72
					34				601	302
					482			656	360	

in the context of extended multilocus phylogenetic analyzes on a taxon set which comprehensively represents the Mucorales as a whole as demonstrated by O'Donnell et al. (2001) and Voigt and Wöstemeyer (2001).

Furthermore, the first descriptions of the genus *Siepmannia* as well as the new combinations of *S. zychae* and *S. parricida* were not in accordance with the articles 37.1, 33.4 and 43.1 of the ICBN (McNeill et al. 2006). Although a validation was made the same year (Kwaśna and Nirenberg 2008b), the genus *Lentamyces* for the species *L. parricida* and *L. zychae* was validly published before (Hoffmann and Voigt 2008). The final phylogenetic position of the genus *Siepmannia* and its relation to *Lentamyces* requires further investigations; even a combination in one family is possible.

## 19.4 Morphological and Molecular Differentiation of Affected Species Belonging to *Absidia* sensu lato

Although the traditional approach of comparative morphology for species differentiation is quite easy to perform, some if not most of the existing descriptions keys are now outdated. The more the data gained, the more changes in taxonomical designations were performed as a consequence of varying interrelationships. The increase of importance of molecular data combined with a broad range of analytical tools allows improvements in statistically supported phylogenetic relationships at all taxonomical levels. Natural relationships among species could not predict and be fully resolved on the basis of morphology alone but by comparative molecular phylogenetics as well, and therefore, in order to assign an organism to its natural affiliation, morphology should be supplemented with additional and independent data.

In the following a synoptic key to the affected genera and species of *Absidia* sensu lato is given, which extends the detailed descriptions given by Ellis and Hesseltine (1965, 1966), Hesseltine and Ellis (1961, 1964, 1966), Zycha et al. (1969), Schipper (1990) and Alastruey-Izquierdo et al. (2010). In addition short signature consensus sequences and PCR-restriction fragment length polymorphisms of the ribosomal ITS1-5.8S rDNA-ITS2 region are proposed for genus separation.

## 19.5 Synoptic key to Genera and Species

- 1a. thermotolerant, temperature optimum and maximum above 34°C, growth above 37°C, rapidly growing, sporangiophores often without subsporangial septum, non parasitic on other Mucorales, zygospores without appendaged suspensors ..... **genus *Lichtheimia***
- 1b. not thermotolerant, temperature maximum above 30°C, no growth above 37°C, rapidly growing, sporangiophores with subsporangial septum, non parasitic on other Mucorales, zygospores with appendaged suspensors ..... **genus *Absidia***



- 1c. not thermotolerant, temperature maximum below 30°C, slowly growing, sporangiophores with subsporangial septum, potentially parasitic on other Mucorales, homothallic, warty zygospores without appendaged suspensors .....  
 ..... **genus *Lentamyces***

### 19.5.1 *The Genus Lichtheimia (VUILL. 1903; Lichtheimiaceae K. HOFFM., G. WALTHER & K. VOIGT 2009):*

This Key Is Originally Published in Alastruey-Izquierdo et al. (2010)

- 1a. Sporangia dark brown or dark grey to black; colony diameter after 72 h at 43°C < 2 mm; mature sporangiospores rough and/or > 6.5 µm in their longest extension ..... **2**
- 1b. Sporangia light brownish grey; colony diameter after 72 h at 43°C > 14 mm; mature sporangiospores smooth and < 6.5 µm in their longest extension ..... **3**
- 2a. Giant-cells consistently globose, 60–150 µm in diameter .... ***L. sphaerocystis***
- 2b. Giant-cells (if present) more hypha-like, irregularly swollen, simple to strongly branched, never consistently globose ..... ***L. hyalospora***<sup>[1]</sup>
- 2ba. Mature sporangiospores small (< 5.5 µm), rough, and brownish .....  
 ..... small-spored variants of ***L. hyalospora***<sup>[1]</sup>
- 2bb. Mature sporangiospores larger (on the majority > 5.5 µm), smooth or rough, hyaline or brownish ..... large-spored variants of ***L. hyalospora***<sup>[1]</sup>
- 3a. Colony diameter after 72 h at 43°C > 40 mm, spores ellipsoidal to cylindrical or subglobose to broadly ellipsoidal ..... ***L. ramosa***
- 3b. Colony diameter after 72 h at 43°C < 27 mm, spores never consistently ellipsoidal to cylindrical ..... **4**
- 4a. Densely branched giant-cells, 380–760 (–900) × 320–660 (–770) µm, present in 2-week-old YEA cultures ..... ***L. ornata***
- 4b. Giant-cells absent from 2-week-old YEA cultures ..... ***L. corymbifera***

<sup>[1]</sup>*L. hyalospora* is now a synonym of *L. blakesleeana* (Alastruey-Izquierdo et al. 2010). *L. hyalospora* was originally separated from *L. blakesleeana* by the formation of larger and unusual hyaline mitospores. A prospective new separation of both species in varieties or formae could not be excluded.

### 19.5.2 *The Genus Absidia (Tiegh. 1876; Absidiaceae Arx 1982)*

- 1a. all sporangia pyriform, apophysate, with prominent columella, columellae often with apical projection, without chlamydospores ..... **2 (*Absidia*)**
- 1b. dark-colored chlamydospores within aerial hyphae .....  
 ..... ***Chlamydoabsidia padenii***



- 2a. sporangiophores circinate and arising individually, sporangia mutant .....  
.....**A. reflexa** (uncertain species)
- 2b. sporangiophores not bent ..... **3**
- 3a. sporangiospores smooth ..... **4**
- 3b. sporangiospores roughened to echinulate .... **A. scabra** (uncertain species)
- 4a. sporangiospores spherical, heterothallic ..... **5**
- 4b. sporangiospores spherical, homothallic .....**A. septata** (uncertain species)
- 4c. sporangiospores throughout not spherical, heterothallic or homothallic .....**8**
- 5a. all sporangiospores spherical 2.5–5.5  $\mu\text{m}$  ..... **6**
- 5b. all sporangiospores spherical up to 8.9  $\mu\text{m}$  ..... **A. macrospora**
- 6a. young mycelium violet ..... **A. caerulea**
- 6b. young mycelium of different color ..... **7**
- 7a. sporangiophores single or in whorls, often two; young mycelium strain specifically colored (white, green, brown) ..... **A. glauca**
- 7b. sporangiophores single or in abundant whorls, mostly more than two; young mycelium green to grey .....**A. californica**
- 8a. sporangiospores more or less cylindrical, species homothallic ..... **9**
- 8b. sporangiospores diverse (oval, cylindrical, globose, conical, irregular), species heterothallic ..... **10**
- 9a. young cultures violet or reddish ..... **A. anomala**
- 9b. young cultures white, never violet or reddish, if suspensors typically unequal in size then appendages originate from the larger one .....  
..... **A. spinosa var. spinosa**
- 9c. zygosporer suspensors equal in size, appendages originating from both suspensors .....**A. spinosa var. biappendiculata**
- 9d. similar to variety *spinosa* but abundant azygospores with up to 3 spores on one suspensor .....**A. spinosa var. azygospora**
- 10a. abundant secondary sporangia in older cultures, sporangiospores oval to short cylindrical .....**A. repens**
- 10b. no secondary sporangia, sporangiospores conical or clearly cylindrical ....**11**
- 11a. sporangiospores conspicuously conical .....**A. cuneospora**
- 11b. sporangiospores diverse, irregularly shaped, globose and cylindrical-ellipsoidal, columellae without distinct apical projections ....**A. heterospora**
- 11c. sporangiospores regularly cylindrical ..... **12**
- 12a. young colonies on PDA white, older colonies greyish-brown, sporangiophores in whorls (1–4), zygosporer with unequal suspensors .....  
.....**A. cylindrospora var. cylindrospora**
- 12aa. appears similar to *A. pseudocylindrospora* but older colonies on PDA medium of dark brownish grey color, no mating with *A. cylindrospora* ....  
.....**A. cylindrospora var. nigra**
- 12ab. colonies on PDA light greyish brown; on Czapek-agar forming rhizomorph-like hyphae, no mating with *A. cylindrospora* .....  
.....**A. cylindrospora var. rhizomorpha**
- 12b. similar to *A. cylindrospora*, but older colonies blackish brown pigmented, sporangiophores in whorls up to six .....**A. fusca**

- 12c. similar to *A. cylindrospora*, young colonies grey, zygospores with equal suspensors ..... *A. pseudocylindrospora*  
 12d. young colonies brownish, temperature optimum between 15–20°C, no growth at 30°C ..... *A. psychrophilia*

### 19.5.3 *The Genus Lentamyces (K. HOFFM. and K. VOIGT 2008)*

- 1a on MEX mycelium not higher than 3 mm, thin, slow growing, brownish, facultative parasitic on other Mucorales, abundant zygospores, sporangiospores cylindrical 1.6–2.5 µm × 1.9–3.3 µm ..... *L. parricida*  
 1b not parasitic on other Mucorales, rare zygospores, sporangiospores cylindrical 1.2–2.2 µm × 1.6–3.3 µm ..... *L. zychnae*

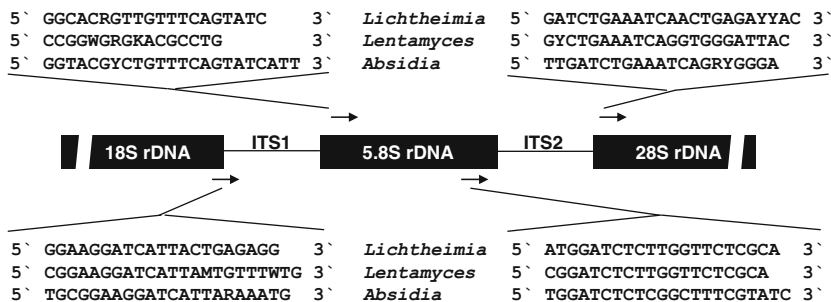
## 19.6 Some Remarks to Uncertain Species

Among the literature species epithets exist which are only once encountered and described. The species are not available in any culture collection and, if there was no mistake in the observations described, could be presumed as lost. Therefore, *A. scabra*, *A. septata* and *A. reflexa* still remain within the genus *Absidia* until they are rediscovered because the passed down morphological descriptions match those of *Absidia*. Except for the roughened to echinulate sporangiospores and missing septae beneath the sporangium, *A. scabra* COCCONI resembles the characteristics of *A. caerulea* (Cocconi 1899; Ellis and Hesseltnine 1965). The description of *A. septata* TIEGH. is also nearly identical with those of *A. caerulea* but differs in the presence of homothallically formed zygospores which were definitively illustrated (van Tieghem 1876; Ellis and Hesseltnine 1965). *A. reflexa* TIEGH. described by van Tieghem (1876) shows obvious circinate sporangiophores which is not typical for *Absidia* (Ellis and Hesseltnine 1965). Until a rediscovery and without a profound phylogenetic study, a clear designation to any species or genera remains uncertain.

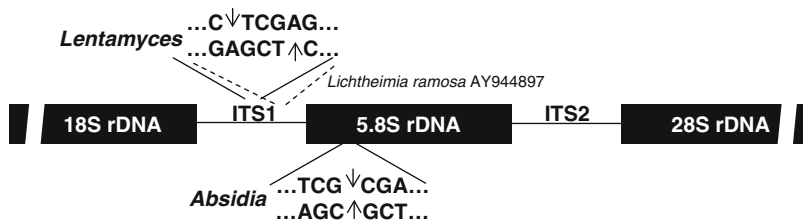
Because they lacked sufficient diagnoses or absence in appropriate strain collections the following taxa were not considered here: *A. aegyptiacum* SATORY, MEYER & TAWFIK 1939; *A. capillata* TIEGH. 1876; *A. clavata* B.S. MEHROTRA & NAND 1967; *A. fassatae* VÁNOVÁ 1971; *A. griseola* H. NAGAN. & HIRAHARA 1970; *A. inflata* J.H. MIRZA, S.M. KHAN, S. BEGUM & SHAGUFTA 1979; *A. narayanai* SUBRAHAMANYAM 1990; *A. robusta* RACIBORSKI 1899; *A. tuneta* RENNER & MUSKAT 1958; *A. ushtrina* S.C. ARARWAL 1974.

## 19.7 Molecular Key to the Genera

The augmentation of generally easy-to-access morphological data with molecular characteristics will support the current concepts of species relationships to specific genera. Sequences of the nuclear internal transcribed spacer (ITS) region already



**Fig. 19.2** Schematic illustration of the nuclear ribosomal DNA cluster including internal transcribed spacer regions (ITS) 1 and 2 with short signature sequences to differentiate between the genera *Absidia sensu stricto*, *Lentamyces* and *Lichtheimia*. Signature sequences are located at the 18S rDNA – ITS1 boundary, at the 5' and 3' end of the 5.8S rDNA, and at the 5' end of the 28S rDNA. Positions of the signature sequences could slightly vary



**Fig. 19.3** Schematic illustration of the nuclear ribosomal DNA cluster including internal transcribed spacer regions (ITS) 1 and 2 with unique restriction sites useful for the discrimination of the genera *Absidia sensu stricto*, *Lentamyces* and *Lichtheimia*. Species in the genus *Absidia sensu stricto* possess a unique restriction site for the enzyme *Bsp68I* (*NruI*), recognizing the motif TCGCGA) near the 5' end of the 5.8S rDNA, cutting ITS sequences (between 500–700 bp) in two fragments nearly about the same size. In the middle of the ITS1 sequence (around position 100) is a *XhoI* restriction site located (recognizing the motif CTCGAG), unique for the genus *Lentamyces*. With the exception AY944897 both sequence motifs occur not within sequences of the genus *Lichtheimia*

proved to be useful for species designation and phylogenetic analyzes concerning members of the genera *Absidia*, *Lentamyces* and *Lichtheimia* (Machouart et al. 2006; Schwarz et al. 2006; Hoffmann et al. 2007, 2009a). Several ITS sequences available from GenBank ([www.ncbi.nlm.nih.gov](http://www.ncbi.nlm.nih.gov); listed in the methodical Sect. 9.3.) were analyzed for short sequence fragments useful to differentiate between genera (Fig. 19.2). Signature sequences are located at the nuclear 18S ribosomal DNA – ITS1 boundary, at the 5' and at the 3' end of the 5.8S rDNA, and at the 5' end of the 28S rDNA. Positions of the signature sequences could slightly vary.

Furthermore, restriction site analyzes of the sequenced PCR products revealed unique sites potentially useful for differentiation of the genera (Fig. 19.3). Within *Absidia sensu stricto* the enzyme *Bsp68I* (TCG CGA) cuts the total ITS sequences within the 5.8S rDNA region in two fragments nearly about the same size. There is no *Bsp68I* restriction site within the analyzed sequences of species belonging to the

genera *Lentamyces* or *Lichtheimia* (or *Siepmannia*). A unique recognition site for the enzyme *Xho*I is present within *Lentamyces* (but not within *Siepmannia*), nearly half cutting ITS1 (around position 100 of the total ITS1-5.8S rDNA-ITS2 sequence). *Absidia* and *Lichtheimia* show no *Xho*I restriction site with one exception. The ITS1 region of *Lichtheimia ramosa* (AY944897) is restricted by *Xho*I after two-thirds (Fig. 19.3).

## 19.8 Combining Morphological and Molecular Characters: An Example

Bearing in mind that the name of a type strain is intrinsically tied to its morphological features, a molecular-based identification should not neglect a profound check on morphology. One example is illustrated by *Absidia repens*. This species is characterized by the presence of uniquely formed secondary sporangia beneath typical *Absidia*-like sporangia. *A. repens* is one of the few species with available sequences from different geographical populations. In Fig. 19.4, an alignment of three isolates is displayed. Two isolates are from America (A) and the isotype is from Europe (E). Both American isolates are similar to each other with 95% identity but differ considerably from the European isolate (52% identity). As already outlined in detail by Hoffmann et al. 2009a, information on the geographical origin could solve differences within isolates caused by geographically-based species deviation and will eventually support the erection of new formae, varieties or even species. Such a cryptic species with no obvious morphological differences is *A. repens*, but a separation in two distinct species requires a more profound investigation of the already described isolates. A synonym of *A. repens*, namely *A. japonica*, was isolated in Japan and may easily represent a distinct cryptic species.

## 19.9 Methodological Section

### 19.9.1 Media for Cultivation

Media for cultivation, mentioned in the description keys were PDA (see DSMZ medium 129), Czapek-Agar (see DSMZ medium 130) and MEX (3% malt extract supplemented with 0.5% yeast extract); YEA (yeast extract, Difco, Alphen a/d Rijn, The Netherlands); MEA (malt extract, Difco).

### 19.9.2 Methods for Strain Maintenance, Cultivation, and Sequence Analyses

Methods for strain maintenance, cultivation, and sequence analyses were previously described by Hoffmann et al. (2007) and Hoffmann and Voigt (2008).

CBS101.32 (A) 1	-----	50
KAS3611 (A) 1	-----	50
CBS115583 (E) 1	GAAATGCTGGGAAGCCTCCGGGAGGACCTAACTTTTTTCTACTGGTCCCT	50
CBS101.32 51	-----	100
KAS3611 51	-----	100
CBS115583 51	TGTTTTTTTAGGGGTTGCTTGGGAAGGATTTCGTTTCTTCCCTTGATGT	100
CBS101.32 101	-----AAAATGCGGCCGGTCTCTTTCCGGGAGGATTGGTCAACAGATTTA	150
KAS3611 101	-----AAAATGCGGCTGGCTCTCTTT--GGAGGGTTGGTCAACAGATTTA	150
CBS115583 101	TTGGGGGAATTTTATTATTCCCCCTTCATGGGAAAGTTTTACTACTTTCC	150
CBS101.32 151	ATTCTGTGCACTGTTTTTAATTGGGGGTTTTCTTGAAAAAGGGAGCCTCC	200
KAS3611 151	ATTCTGTGCACTGTTTTTAATTGGGGGTTTTCTTGAAAAAGGGAGCCTCC	200
CBS115583 151	CCTTCTCCCACCCTGGGTAAA-GCCCTTTTTCCTTTGGGAGAATCCGGTT	200
CBS101.32 201	TGCCCTGG-GTATTGCTCTTTTTCCTTTGGGAAGAAATCAGCTTGCCTTA	250
KAS3611 201	TGCCCTGG-GTATTGCTCTTTTTCCTTTGGGAAGAAATCAGCTTGCCTTA	250
CBS115583 201	TGCCCAGTTGAATCCCCCTTCTTTCATAGGGGGGGG-----TTTTCAAG	250
CBS101.32 251	TTAATATACTATTCTGACTGAACTAAAACAGAAAATTGTTTTAACACATAA	300
KAS3611 251	TTAATATACTATTCTGACTGAACTAAAACAGAAAATTGTTTTAACACATAA	300
CBS115583 251	TTTATATACTATTTTGACTGAACTAAA-CAGAAA-TTGTTTTAACACTTAA	300
CBS101.32 301	ACAACTTTCAGCAATGGATCTCTCGGCTTTCGTATCGATGAAGAACGCAG	350
KAS3611 301	ACAACTTTCAGCAATGGATCTCTCGGCTTTCGTATCGATGAAGAACGCAG	350
CBS115583 301	ACAACTTTCAGCAATGGATCTCTCGGCTTTCGTATCGATGAAGAACGCAG	350
CBS101.32 351	CAAATCGCGATATGTAGTGTGATCTGCCTATAGTGAATCATCAAATCTTT	400
KAS3611 351	CAAATCGCGATATGTAGTGTGATCTGCCTATAGTGAATCATCAAATCTTT	400
CBS115583 351	CAAATCGCGATATGTAGTGTGATCTGCCTATAGTGAATCATCAAATCTTT	400
CBS101.32 401	GAACGCATCTTGCACCCTTGGGTATTCCTGAGGGTACGCCTGTTTCAGTA	450
KAS3611 401	GAACGCATCTTGCACCCTTGGGTATTCCTGAGGGTACGCCTGTTTCAGTA	450
CBS115583 401	GAACGCATCTTGCACCCTTGGGTATTCCTGAGGGTACCCCTGTTTCAGTA	450
CBS101.32 451	TCATTTTAACTTCATCTCCTTTCGAGGGGTTG-----AAAAAT	500
KAS3611 451	TCATTTTAACTTCATCTCCTTTCGAGGG-TTTCG-----AAAAAT	500
CBS115583 451	TCATTTTATCTTCTTTCCTTCCGTCCTTAGGTTGGTGGGGAAGGGAAAAAT	500
CBS101.32 501	CACTACTGGCCATTGAGTACCTTTGT-----GTATTCTCGGCTGAAAT	550
KAS3611 501	CACTACTGGCCATTGAGTACTTTATT-----GTGCTTCTCGGCTGAAAT	550
CBS115583 501	CAC-ACTCGCC-TAGAGTACTAGTTTAGACCGGTGCTTCTTGGCTGAAAT	550
CBS101.32 601	AATCT-TATGGTTTCCCTTATGACTGGGGCAATTACCCTTTGGTAGAAT	600
KAS3611 601	AATTT-TATGGTTTCCCTTATGACTGGGGCAATTACCCTTTGGTAGAAT	600
CBS115583 601	TATTGATACAGTTTTCCCTTTGACTTTAAAGGGGTACCCTTTGGTAGCCT	600
CBS101.32 651	TTATTTTTTACAAAAGAAAAATTGAAGCCAGTCTAGAAGCTATACCGTC	650
KAS3611 651	TCATTTTTTACAAAAGAAACAATTGAAGCCAGTCTAGAAGTCATACCTTC	650
CBS115583 651	TTC-----	650
CBS101.32 701	GAAAGACAACCCCAAAA	718
KAS3611 701	-----ACCCCAAAA	718
CBS115583 701	-----	718

**Fig. 19.4** Alignment of sequenced ITS1-5.8S rDNA-ITS2 regions from three different isolates of *Absidia repens*. CBS101.32 and KAS3611 were isolated in America (A). The isotype of the species is of European origin (E). The European isolate differs primarily by a major indel (insertion/deletion) within ITS1 as well as unambiguously aligned regions within ITS1 and ITS2 of the American strains

Bayesian inference was done using MrBayes v3.1.2 (Huelsenbeck and Ronquist 2001; Ronquist and Huelsenbeck 2003). The alignment consists of combined sequences of partial 18S rDNA (1202 characters), partial 28S rDNA (389 characters), partial sequences coding for *act* (807 characters) and *tef* (1092 characters).

**Table 19.3** Species and GenBank accession numbers studied in the Bayesian inference (Fig. 19.1)

Species	GenBank accession numbers			
	<i>act</i>	<i>tef</i>	18S rDNA	28S rDNA
<i>Absidia caerulea</i>	EU736223	EU736245	EU736272	EU736299
<i>A. californica</i>	EU736224	EU736247	EU736274	EU736301
<i>A. glauca</i>	EU736225	EU736248	EU736275	EU736302
<i>A. macrospora</i>	AY944760	EU736249	EU736276	EU736303
<i>A. psychrophilia</i>	AY944762	EU736252	EU736279	EU736306
<i>A. repens</i>	AJ287136	AF157228	AF113410	AF113448
<i>A. spinosa</i>	EU736227	EU736253	EU736280	EU736307
<i>Blakeslea trispora</i>	AJ287143	AF157235	AF157124	AF157178
<i>Chaetocladium brefeldii</i>	AJ287144	AF157236	AF157125	AF157179
<i>Chlamydoabsidia padenii</i>	AJ287146	AF157238	AF113415	AF113453
<i>Choanephora cucurbitarum</i>	AJ287147	AF157239	AF157127	AF157181
<i>Cunninghamella bertholletiae</i>	AJ287151	AF157243	AF113421	AF113459
<i>C. echinulata</i>	AJ287152	AF157244	AF157130	AF157184
<i>Dichotomocladium elegans</i>	AJ287153	AF157245	AF157131	AF157185
<i>Gongronella butleri</i>	AJ287160	AF157252	AF157137	AF157191
<i>Halteromyces radiatus</i>	AJ287161	AF157253	AF157138	AF157192
<i>Hesseltinella vesiculosa</i>	AJ287163	AF157255	AF157140	AF157194
<i>Lentamyces parricida</i>	AY944761	EU736250	EU736277	EU736304
<i>L. zychae</i>	EU736228	EU736255	EU736282	EU736309
<i>Lichtheimia corymbifera</i>	AJ287134	AF157227	AF113407	AF113445
<i>L. hyalospora</i>	AJ287132	AF157225	AF157117	AF157171
<i>L. hyalospora</i>	EF030531	EU826384	EU826360	EU826368
<i>L. ramosa</i> <sup>a</sup>	EU826377 <sup>a</sup>	EU826382 <sup>a</sup>	EU826361 <sup>a</sup>	EU826370 <sup>a</sup>
<i>Mortierella alpina</i>	EU736236	EU736263	EU736290	EU736317
<i>M. multivaricata</i>	AJ287168	AF157260	AF157144	AF157198
<i>M. verticillata</i>	AJ287170	AF157262	AF157145	AF157199
<i>Mucor racemosus</i>	AJ287177	AF157268	AF113430	AF113471
<i>Mycotypha africana</i>	AJ287180	AF157271	AF157147	AF157201
<i>M. microspora</i>	AJ287181	AF157272	AF157148	AF157202
<i>Parasitella parasitica</i>	AJ287182	AF157273	AF157149	AF157203
<i>Phycomyces blakesleeanus</i>	AJ287184	AF157275	AF157151	AF157205
<i>Radiomyces spectabilis</i>	AJ287190	AF157281	AF157157	AF157211
<i>Rhizomucor miehei</i>	AJ287191	AF157282	AF113432	AF113473
<i>R. pusillus</i>	AJ287192	AF157283	AF113433	AF113474
<i>Rhizopus oryzae</i>	AJ287198	AF157289	AF113440	AF113481
<i>R. stolonifer</i>	AJ287199	AF157290	AF113441	AF113482
<i>Saksenaea vasiformis</i>	AJ287200	AF157291	AF113442	AF113483
<i>Spinellus fusiger</i>	AJ287201	AF157292	AF157159	AF157213
<i>Thermomucor indiciae-seudaticae</i>	AJ287208	AF157299	AF157165	AF157219
<i>Umbelopsis isabellina</i>	AJ287209	AF157300	AF157166	AF157220
<i>U. nana</i>	AJ287210	AF157301	AF157167	AF157221
<i>U. ramanniana</i>	AJ287166	AF157258	X89435	AF113463

<sup>a</sup>described as *Absidia idahoensis* var. *thermophila* (Chen and Zheng 1998); sequences generated in this study

Forty-two taxa were included, using three species of *Mortierella* as outgroup (Table 19.3). Starting from a random tree, two runs, each with four chains, were conducted for 5,000,000 generations. Thousand trees were sampled per run. The consensus tree was calculated using the halfcompat option with a 25% burn-in. The node confidence values (posterior probabilities, in percent) are shown above the branches in Fig. 19.1.

### 19.9.3 PCR-RFLP and Sequence Analysis

ITS sequences were retrieved from GenBank ([www.ncbi.nlm.nih.gov](http://www.ncbi.nlm.nih.gov)). Sequences for the genus *Lichtheimia*: *L. blakesleeana* (AY944892-4, EF030530), *L. corymbifera/ramosa* (DQ118984, DQ118982, AY944895, AY944897, AY944896); genus *Lentamyces*: *L. parvicida* (AY944884/5), *L. zychae* (EF030529/AJ968561); genus *Absidia* sensu stricto: *A. californica* (AY944872/3), *A. caerulea* (AY944866-71), *A. macrospora* (AY944882/3), *A. glauca* (AY944875-81), *A. spinosa* (AY944886-8), *A. repens* (EF030527/8, AY944890/1, AJ877962, FJ849793), *A. pseudocylindrospora* (EF030525/6); *A. anomala* (EF030523), *A. cylindrospora* (AY944889), *A. psychrophilia* (AY944874), *A. cuneospora* (EF030524); genus *Siepmannia*: *S. pineti* (AJ748134), *S. lariceti* (AJ748857); *Mucor circinelloides* (AJ878535); *Fennellomyces linderi* (AJ878536). *In silico* restriction analysis as well as calculation of sequence similarities was done using BioEdit v.7.0.9.0 (Hall 1999).

**Acknowledgments** This work was supported by a grant of the Deutsche Forschungsgemeinschaft (VO 772/9-1) and by the Thüringer Ministerium für Wissenschaft, Forschung und Kunst. The author wishes to express her gratitude to Kerstin Voigt (University of Jena, Germany) and Grit Walther (CBS, Centraalbureau voor Schimmelcultures Utrecht, The Netherlands) for critically reading the manuscript and valuable advices, to Keith A. Seifert (Eastern Cereal and Oilseed Research Centre, Agriculture and Agri-Food Ottawa, Ontario, Canada) for kindly providing a culture and sequence information of *Absidia repens* KAS3611, to Ru-yong Zheng (Key Laboratory of Systematic Mycology and Lichenology, Institute of Microbiology, Chinese Academy of Sciences, Beijing, China) for providing *Absidia idahoensis* var. *thermophila* strain AS 3.4808 and to Gisela Baumbach for excellent assistance in strain maintenance.

## References

- Abdel-Fattah AF, Ismail AMS, El-Aasar SA (1984) Production of rennin-like enzyme by *Absidia cylindrospora*. *Agric Waste* 11:125–131
- Alastruoy-Izquierdo A, Hoffmann K, Hoog de GS, Rodriguez-Tudela JL, Voigt K, Bibashi E, Walther G (2010) Species recognition and clinical relevance of the zygomycetous genus *Lichtheimia* (syn *Mycocladius*, *Absidia* spp.) in revision
- Bainier G (1882) Étude sur les Mucorinées. Thèse, Paris, France, p 136
- Bainier G (1889) Sur l'*Absidia caerulea*. *Bull Soc Bot France* 36:184
- Bainier G (1903) Sur quelques espèces de Mucorinées nouvelles ou peu connues. *Bull Soc Mycol France* 19:153–172
- Beauverie J (1900) *Mycocladius verticillatus*. *Ann Univ Lyon* 3:162–180

- Brezezowska E, Dmochowska-Gładysz J, Kolek T (1996) Biotransformations XXXIX Metabolism of testosterone, androstenedione, progesterone and testosterone derivatives in *Absidia coerulea* culture. *J Steroid Mol Biol* 57:357–362
- Chen GQ, Zheng RY (1998) A new thermophilic variety of *Absidia idahoensis* from China. *Mycotaxon* 69:173–179
- Chen G, Yang M, Lu Z, Zhang J, Huang H, Liang Y, Guan S, Song Y, Wu L, Guo D (2007) Microbial Transformation of 20(S)-Protopanaxatriol-Type Saponins by *Absidia coerulea*. *J Nat Prod* 70:1203–1206
- Cocconi G (1899) Ricerche intorno ad una nuova Mucorinea del genere *Absidia* van Tiegh. *Accad Sci Bologna Mem Ser* 5:85–90
- Cohn FJ (1884) *Mucor corymbifer*. In: Lichtheim L (ed) Über pathogene Mucorineen und die durch sie erzeugten Mykosen des Kaninchens. *Z Klin Med* 7:149–177
- Crous PW, Gams W, Stalpers JA, Robert V, Stegehuis G (2004) MycoBank: an online initiative to launch mycology into the 21st century. *Stud Mycol* 50:19–22
- Dai T, Tegos GP, Burkatovskaya M, Castano AP, Hamblin MR (2009) Chitosan acetate bandage as a topical antimicrobial dressing of infected burns. *Antimicrob Agents Chemother* 53:393–400
- Demirci F, Noma Y, Kirimer N, Can Başer KH (2004) Microbial Transformation of (-)-Carvone. *Z Naturforsch* 59:389–392
- Ellis JJ, Hesseltine CW (1965) The genus *Absidia*: globose-spored species. *Mycologia* 57:222–235
- Ellis JJ, Hesseltine CW (1966) Species of *Absidia* with ovoid sporangiospores II. *Sabouraudia* 5:57–77
- Gonzalez CE, Rinaldi MG, Sugar AM (2002) Zygomycosis. *Infect Dis Clin North Am* 16:895–914
- Guiraud P, Bonnet JL, Boumendjel A, Kadri-Dakir M, Dusser M, Bohatier J, Steiman R (2008) Involvement of *Tetrahymena pyriformis* and selected fungi in the elimination of anthracene, and toxicity assessment of the biotransformation products. *Ecotoxicol Environ Saf* 69:296–305
- Hagem O (1908) Untersuchungen über norwegische Mucorineen. *Math-Nat Kl* 7:1–50
- Hall TA (1999) BioEdit: a user-friendly biological sequence alignment editor and analysis program for Windows 95/98/NT. *Nucleic Acids Symp* 41:95–98
- Hesseltine CW, Ellis JJ (1961) Notes on Mucorales, especially on *Absidia*. *Mycologia* 53:406–426
- Hesseltine CW, Ellis JJ (1964) The genus *Absidia*: *Gongronella* and cylindrical-spored species of *Absidia*. *Mycologia* 56:568–601
- Hesseltine CW, Ellis JJ (1966) Species of *Absidia* with ovoid sporangiospores I. *Mycologia* 58:761–785
- Hibbett DS, Binder M, Bischoff JF, Blackwell M, Cannon PF, Eriksson OE, Huhndorf S, James T, Kirk PM, Lücking R, Lumbs HT, Lutzoni F, Matheny PB, McLaughlin DJ, Powell MJ, Redhead S, Schoch CL, Spatafora JW, Stalpers JA, Vilgalys R, Aime MC, Aptroot A, Bauer R, Begerow D, Benny GL, Castlebury LA, Crous PW, Dai YC, Gams W, Geiser DM, Griffith GW, Gueidan C, Hawksworth DL, Hestmark G, Hosaka K, Humber RA, Hyde KD, Ironside JE, Kõljalg U, Kurtzman CP, Larsson KH, Lichtwardt R, Longcore J, Miadlikowska J, Miller A, Moncalvo JM, Mozley-Standridge S, Oberwinkler F, Parmasto E, Reeb V, Rogers JD, Roux C, Ryvarden L, Sampaio JP, Schüssler A, Sugiyama J, Thorn RG, Tibell L, Untereiner WA, Walker C, Wang Z, Weir A, Weiss M, White MM, Winka K, Yao YJ, Zhang N (2007) A higher-level phylogenetic classification of the fungi. *Mycol Res* 111:509–547
- Hoffmann K, Voigt K (2008) *Absidia parricida* plays a dominant role in biotrophic fusion parasitism among mucoralean fungi (Zygomycetes): *Lentamyces*, a new genus for *A parricida* and *A zychnae*. *Plant Biol* 11:537–554
- Hoffmann K, Discher S, Voigt K (2007) Revision of the genus *Absidia* (Mucorales, Zygomycetes): based on physiological, phylogenetic and morphological characters: thermotolerant *Absidia* spp. form a coherent group, the Mycocladiaceae fam nov. *Mycol Res* 111:1169–1183
- Hoffmann K, Telle S, Walther G, Eckart M, Kirchmair M, Prillinger H, Prazenica A, Newcombe G, Dölz F, Papp T, Vágvölgyi C, deHoog S, Olsson L, Voigt K (2009a) Diversity, genotypic identification, ultrastructural and phylogenetic characterization of zygomycetes from different ecological habitats and climatic regions: limitations and utility of nuclear ribosomal DNA



- barcode markers. In: Gherbawy Y, Mach RL, Rai M (eds) Current advances in molecular mycology. Nova Science Publishers, Inc, New York, pp 263–312
- Hoffmann K, Walther G, Voigt K (2009b) *Mycocladus* vs *Lichtheimia*: a correction (Lichtheimiaceae fam. nov., Mucorales, Mucoromycotina). Mycol Res 113:277–278
- Huelsenbeck JP, Ronquist F (2001) MRBAYES: bayesian inference of phylogeny. Bioinformatics 17:754–755
- Huszczka E, Dmochowska-Gladysz J (2003) Transformation of testosterone and related steroids in *Absidia glauca* culture. J Basic Microbiol 43:113–120
- Kirk PM, Cannon PF, Minter DW, Stalpers JA (2008) Dictionary of the fungi, 10th edn. CABI, Wallingford, United Kingdom
- Kwaśna H, Nirenberg HI (2008a) *Siepmannia*, a new genus in the Mucoraceae. Mycologia 100:259–271
- Kwaśna H, Nirenberg HI (2008b) Validation of the genus *Siepmannia* (Mucoraceae) and its four species. Polish Bot J 53:187
- Kwaśna H, Ward E, Bateman GL (2006) Phylogenetic relationships among Zygomycetes from soil based on ITS1/2 rDNA sequences. Mycol Res 110:501–510
- Lendner A (1907) Sur quelques Mucorinées. Bull Her Boiss, Sér II 7:249–251
- Lendner A (1908) Les Mucorinées de la Suisse. Mat Flore cryptogamique Suisse 3:1–180
- Lendner A (1924) Une Mucorinée nouvelle du genre *Absidia*. Bull Soc Bot Genève, Ser II 15:147–152
- Machouart M, Larché J, Burton K, Collomb J, Maurer P, Cintrat A, Biava MF, Greciano S, Kuijpers AFA, Contet-Audonnet N, deHoog GS, Gérard A, Fortier B (2006) Genetic identification of the main opportunistic Mucorales by PCR-Restriction Fragment Length Polymorphism. J Clin Microbiol 44:805–810
- McNeill J, Barrie FR, Burdet HM, Demoulin V, Hawksworth DL, Marhold K, Nicolson DH, Prado J, Silva PC, Skog JE, Wiersema JH, Turland NJ (eds) (2006) International code of botanical nomenclature (Vienna code). Regnum Vegetabile 146 ARG Ganter Verlag KG, Ruggell, Lichtenstein
- Mirza JH, Khan SM, Begum S, Shagufta S (1979) Mucorales of Pakistan. University of Agriculture, Faisalabad, Pakistan, p 183
- Muzzarelli RAA, Illari P, Tarsi R, Dubini B, Xia W (1994) Chitosan from *Absidia coerulea*. Carbohydr Polym 25:45–50
- O'Donnell K, Lutzoni FM, Ward TJ, Benny GL (2001) Evolutionary relationships among mucoralean fungi (Zygomycota): Evidence for family polyphyly on a large scale. Mycologia 93:286–296
- Ribaldi M (1952) Sopra un interessante Zigomicete terricola: *Gongronella urceolifera* n gen., et n sp. Rivista di Biologia 44:157–166
- Ribes JA, Vanover-Sams CL, Baker DJ (2000) Zygomycetes in human disease. Clin Microbiol Rev 13:236–301
- Robert V, Stegehuis G, Stalpers J (2005) The MycoBank engine and related databases. <http://www.mycobank.org>
- Ronquist F, Huelsenbeck JP (2003) MRBAYES 3: bayesian phylogenetic inference under mixed models. Bioinformatics 19:1572–1574
- Rungsardthong V, Wongvuttanakul N, Kongpien N, Chotiwaranon P (2006) Application of fungal chitosan for clarification of apple juice. Process Biochem 41:589–593
- Schipper MAA (1990) Notes on Mucorales – I. Observations on *Absidia*. Persoonia 14:133–149
- Schwarz P, Bretagne S, Gantier JC, Garcia-Hermoso D, Lortholary O, Dromer F, Dannaoui E (2006) Molecular identification of Zygomycetes from culture and experimentally infected tissues. J Clin Microbiol 44:340–349
- Sydow H (1903) Referate und kritische Besprechungen. Annals Mycologici 1:371
- Thirion-Delalande C, Guillot J, Jensen HE, Crespeau FL, Bernex F (2005) Disseminated acute concomitant aspergillosis and mucormycosis in a pony. J Vet Med A Physiol Pathol Clin Med 52:121–124

- Van Tieghem P (1876) Troisième mémoire sur les Mucorinées. *Ann Sci Nat Bot* 4:312–399
- Vánová M (1991) Nomen novum, nomenclatural changes and taxonomic rearrangements in Mucorales. *Ceská Mykologie* 45:25–26
- Voigt K, Wöstemeyer J (2001) Phylogeny and origin of 82 zygomycetes from all 54 genera of the Mucorales and Mortierellales based on combined analysis of actin and translation elongation factor EF-1alpha genes. *Gene* 270:113–120
- Voigt K, Cigelnik E, O'Donnell K (1999) Phylogeny and PCR identification of clinical important Zygomycetes based on nuclear ribosomal-DNA sequence data. *J Clin Microbiol* 37:3957–3964
- Voigt K, Hoffmann K, Einax E, Eckart M, Papp T, Vágvölgyi L, Olsson L (2009) Revision of the family structure of the Mucorales (Mucoromycotina, Zygomycetes) based on multigene-genealogies: phylogenetic analyses suggest a bigeneric Phycomycetaceae with *Spinellus* as sister group to *Phycomyces*. In: Gherbawy Y, Mach RL, Rai M (eds) *Current advances in molecular mycology*. Nova Science Publishers, New York, pp 263–312
- Von Arx JA (1982) On Mucoraceae s. str. and other families of the Mucorales. *Sydowia* 35:10–26
- Vuillemin P (1903) Le genre *Tieghemella* et la série de Absidées. *Bull Soc Mycol France* 19:119–127
- Vuillemin P (1904) Le *Lichtheimia ramosa* (*Mucor ramosus* Lindt) champignon pathogène, distinct du *L. corymbifera*. *Arch Parasitol* 8:562–572
- Zycha H (1935) Pilze II. Mucorineae. *Krypt Fl Mark Brandenburg* 6a, Leipzig
- Zycha H, Siepman R, Linnemann G (1969) Mucorales. Eine Beschreibung aller Gattungen und Arten dieser Pilzgruppe. *J Cramer, Lehre*

# Chapter 20

## Molecular Characters of Zygomycetous Fungi

Xiao-yong Liu and Kerstin Voigt

**Abstract** The traditional Zygomycota has recently been considered polyphyletic as evidenced by a lot of molecular phylogenetic analyses. As a result, it has been distributed into a new phylum and four pending subphyla. Before the taxonomic status for these four subphyla could be determined, the term “zygomycetous fungi” is used for those members traditionally included in the classical phylum Zygomycota. Most current molecular characters of zygomycetous fungi have revealed that there is an obvious conflict between the traditional morphology-based classification scheme and recent DNA-based phylogenies. Except for the notable adjustments at the phylum and subphylum level, major changes at the order level can be observed for Amoebidiales, Basidiobolales, Eccrinales, Entomophthorales, Geosiphonales and Mortierellales. With respect to families, studies on the order Mucorales have suggested an unnatural feature for its traditional family-level classification scheme. Some genera such as *Absidia*, *Cunninghamella* and *Rhizopus* have also been intensively investigated by molecular methods. Genes encoding glucoamylases, polygalacturonases, fumaric acids and polyunsaturated fatty acids, have been intensively studied for industrial purposes. Another important area is the study of the clinical relevance of zygomycetous fungi as pathogens. The poor sensitivity of histological practices, the difficult pure cultivation, and the inaccurate susceptibility and serological tests, have led to the development of highly sensitive and specific molecular techniques, such as microsatellite, oligonucleotide probes, microarrays of gene markers and their expression, fluorescent capillary electrophoresis, real-time PCR (polymerase chain reaction), PCR-RFLP (PCR-restriction fragment

---

X-y. Liu

Key Laboratory of Systematic Mycology and Lichenology, Institute of Microbiology, Chinese Academy of Sciences, No. 1 Beichen West Road, Chaoyang District, Beijing 100101, P. R. China  
e-mail: liuxiaoyong@im.ac.cn

K. Voigt

Institute of Microbiology, School of Biology and Pharmacy, University of Jena, Neugasse 25, 07743 Jena, Germany  
e-mail: kerstin.voigt@uni-jena.de

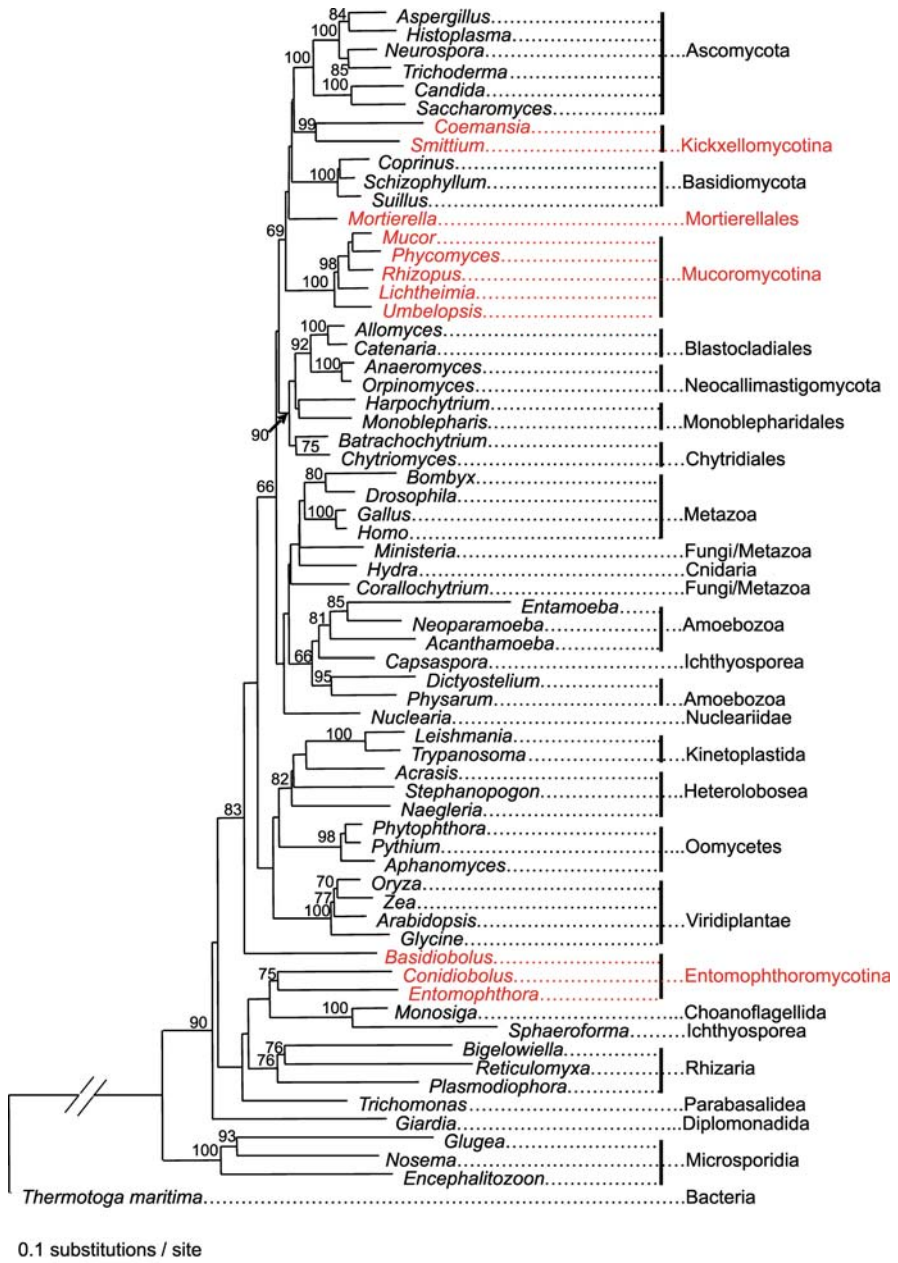
length polymorphism), RAPD (randomly amplified polymorphic DNA), PFGE (Pulsed Field Gel Electrophoresis), and direct sequencing of PCR products, but these methods are not widely available and are reserved primarily for research purposes. New techniques in the molecular identification of zygomycetous fungi need to be further developed and validated. So far, there are only five genome projects relevant to zygomycetous fungi, including *Mortierella verticillata*, *Mucor circinelloides*, *Phycomyces blakesleeanus*, *Rhizopus arrhizus*, and *Smittium culisetae*. More genome projects about industrially, agriculturally, medically and environmentally important zygomycetous fungi are hopeful to provide a better understanding of their natural status in the whole organismic system in the world and their potential to benefit the human being.

## 20.1 Introduction

The phylum Zygomycota in the kingdom Fungi was first proposed by Moreau (1954), but it is invalid and consequently illegal because of a lack of Latin diagnosis or description, which is mandatory for descriptions on or after 1 January 1935 according to the International Code of Botanical Nomenclature (McNeill et al. 2006). Nevertheless, the name Zygomycota has still been recognized by most investigators for more than a semicentury and its members have been gradually increasing until the prosperity of molecular phylogenetic studies triggered by the proposal of universal primers for different rRNA genes and spacers in the early 1990s (White et al. 1990).

Recently, the majority of molecular evidences strongly suggested that the traditional Zygomycota is not monophyletic (Tanabe et al. 2005; James et al. 2006), though its monophyletic feature was supported by the result of analyzing the sequences of genes *rpb1* and *rpb2* (Liu et al. 2006). In the most recent classification of the kingdom Fungi in light of numerous molecular phylogenetic studies, the widely accepted phylum Zygomycota was temporarily rejected and the taxa that have formerly been placed in it were distributed into five parts, including the phylum Glomeromycota and four subphyla of uncertain position (*incertae sedis*), namely Entomophthoromycotina, Kickxellomycotina, Mucoromycotina, and Zoopagomycotina (Hibbett et al. 2007). A three-protein phylogeny, shown in Fig. 20.1, demonstrates the phylogenetic positions of the former three subphyla with the exception of the Zoopagomycotina based on concatenation of translation elongation factor 1alpha, actin and beta tubulin amino acid sequences shown in Table 20.1. The notable taxonomic change of dispersing Zygomycota into different clades reflects to a great extent the current progress on molecular systematics of this basal fungal phylum, even though significant questions are left behind, such as the pending attribution of the four subphyla mentioned above in the kingdom of Fungi.

As compared with the molecular polyphyletic trait of the classical phylum Zygomycota, its diversity in ecological distribution was also well known for a long period of time, ever since the very beginning of the establishment of this



**Fig. 20.1** Concatenated phylogenetic analysis based on a total of 1,262 aligned amino acid characters comprising 500 characters of the translation elongation factor 1 alpha (TEF), 323 characters of actin (ACT) and 439 characters of beta-tubulin (BTUB) from sixty five taxa (Table 20.1). Single alignments were carried out using ClustalX version 1.83 (Higgins and Sharp 1988, 1989; Thompson et al. 1997). Neighbor-joining with distance measure mean character

phylum. Mucorales and Kickxellales are saprobes, the order Entomophthorales comprises obligate parasites of insects, Dimargaritales and Zoopagales are obligate parasites of microorganisms, Asellariales and Harpellales are endocommensals in crustacean guts, and the species of the order Endogonales are ectomycorrhizae. Taking into account the ecological diversity and the molecular polyphyly as well as the invalid naming for the phylum rank, the organisms that have long been included in the traditional Zygomycota refer to zygomycetous fungi in this chapter. That term is far from a new name but is widely accepted by lots of investigators. Here the range of zygomycetous fungi will exclude what is now classified as Glomeromycota, which is a phylum of proven acceptance in the kingdom of *Fungi* (Schüßler et al. 2001). Furthermore, the Eccrinales and the Amoebidiales will be excluded from the zygomycetous fungi *sensu stricto*. Both orders were considered as members of Trichomycetes and now have moved on to a protistan class, the Mesomycezozoa (Cafaro 2005). An extra point worth noticing here targets the Microsporidia, for which zygomycete origin was suggested (Keeling et al. 2000; Keeling 2003) besides the fact that this group will not be included into the zygomycetous fungi in this chapter because of the many evidences revealing its protistan and nonfungal origin influencing its nomenclatural status (Forget et al. 2002; Gill and Fast 2006; Liu et al. 2006).

The morphological taxonomy of zygomycetous fungi was extensively investigated during the last 50 years by some experts (Benjamin 1959, 1966, 1979; Hesseltine and Ellis 1973; O'Donnell 1979; Benny 1982; Lichtwardt 1986; Humber 1989; Benny et al. 2001) and intensively probed by more mycologists with a certain genus as research interests: *Absidia* (Hesseltine and Ellis 1964); *Cunninghamella* (Zheng and Chen 2001); *Mortierella* (Gams 1977); *Mucor* (Schipper 1973, 1975, 1976, 1978); *Rhizopus* (Zheng et al. 2007) etc. These studies circumscribe large genera if compared with genera within the derived fungi, the Asco- and Basidiomycota. For more details on numerous other genera and higher ranks in the zygomycetous fungi as well, it is worth to visit the open website [www.zygomycetes.org](http://www.zygomycetes.org) by Gerald L. Benny which provides a great diversity and a wonderful overview about the zygomycetes.

Looking back into the history, besides morphology, many other molecular and chemical traits such as sterols, fatty acids, nucleic acids, and proteins, were also applied for the identification and the classification of zygomycetous fungi. An investigation of sterol composition of zygomycetous fungi suggested that orders can be distinguished by different sterol chemotypes (Weete and Gandhi 1997). Excitingly, six new ergosterols from a marine zygomycetous fungus were found, providing an evidence for the importance to study on organisms in its endemic habitat (Wang et al. 2008). Regarding fatty acids, there are a few studies, which

←

**Fig. 20.1** (continued) difference was conducted with PAUP\*v4.0b10 (Swofford 1998); negative branch lengths were prohibited. Bootstrap supports (BS) (Felsenstein 1985; 50% majority rule) were obtained by 1,000 bootstrap replicates of a neighbor-joining search using mean character differences as distance measure as implemented in PAUP\*v4.0b10. The tree was rooted to the elongation factor Tu and to the cytoskeletal proteins FtsZ (homologous to tubulin) and MreB (homologous to actin), the latter two first discovered in the thermophilic eubacterium *Thermotoga maritima* (van den Ent et al. 2001), facilitating deep-level phylogenies beyond the divergence of prokaryotes and eukaryotes. Names printed in red colour indicate taxa designated to the zygomycetes

**Table 20.1** Protein sequences retrieved from the International Nucleotide Sequence Database Collaboration and genome projects (see footnotes) with corresponding accession numbers for the corresponding nucleotide sequences. The aligned amino acid sequences were subjected to distance based phylogenetic analyses shown in Fig. 20.1

Genus	GenBank acc. nos.		
	ACT	TEF	BTUB
<i>Acanthamoeba</i>	V00002	AY582829	AY582853
<i>Acrasis</i>	–	AF190771	AF276945
<i>Allomyces</i>	Unpublished	Unpublished	AY131269
<i>Anaeromyces</i>	Unpublished	Unpublished	Unpublished
<i>Aphanomyces</i>	–	EF370041	EF370043
<i>Arabidopsis</i>	U41998	X16430	M20405
<i>Aspergillus</i>	M22869	AB007770	M17519
<i>Basidiobolus</i>	–	DQ282610	AF162060
<i>Batrachochytrium</i> <sup>a</sup>	e_gw1.2.331.1	estExt_40375	estExt_C_90068
<i>Bigelowiella</i>	EF455788	AY729489	EF455767
<i>Bombyx</i>	X05185	D13338	X74951
<i>Candida</i>	X16377	M29934	M19398
<i>Capsaspora</i>	AY724689	DQ403163	–
<i>Catenaria</i>	Unpublished	Unpublished	AY944844
<i>Chytriumyces</i>	AY582841	AY582823	AY944845
<i>Coemansia</i>	–	DQ282615	AY944833
<i>Conidiobolus</i>	–	DQ275337	AF162058
<i>Coprinus</i>	AB034637	AY881026	AB000116
<i>Corallochytrium</i>	AY582844	X55973	AY582850
<i>Dictyostelium</i>	X03283	DQ282609	AF030823
<i>Drosophila</i>	AB003910	X06869	M20419
<i>Encephalitozoon</i>	AF031701	NC_003231	AF297876
<i>Entamoeba</i>	M19871	M92073	AF247192
<i>Entomophthora</i>	EF434860	ABB84538	AY944832
<i>Gallus</i>	X00182	L00677	M11442
<i>Giardia</i>	L29032	D14342	X06748
<i>Glugea</i>	–	D84253	AF162084
<i>Glycine</i>	J01298	X56856	M21296
<i>Harpochytrium</i>	–	AF450113	AF162079
<i>Histoplasma</i>	U17498	U14100	M28359
<i>Homo</i>	M10277	X03558	X00734
<i>Hydra</i>	XP_002154696	D79977	XM_002161824
<i>Leishmania</i>	L16961	XM_001682206	AF345947
<i>Lichtheimia</i>	AJ287134	AF157227	L47261
<i>Ministeria</i>	AY582846	AY582825	AY582851
<i>Monoblepharis</i>	–	AF450112	AY944851
<i>Monosiga</i>	AY026072	AY026073	AY026071
<i>Mortierella</i>	AJ287170	AF157262	AF162071
<i>Mucor</i> <sup>a</sup>	estExt_C_40513	estExt_C_40175	gw1.3.598.1
<i>Naegleria</i>	AF101729	DQ295229	X81050
<i>Neoparamoeba</i>	EU089662	FJ807261	–
<i>Neurospora</i>	U78026	D45837	M13630
<i>Nosema</i>	AF031702	AY452734	AY138803
<i>Nuclearia</i>	AY582845	AY582827	AY582852
<i>Orpinomyces</i>	Unpublished	Unpublished	Unpublished
<i>Oryza</i>	X16280	AF030517	X79367

(continued)

**Table 20.1** (continued)

Genus	GenBank acc. nos.		
	ACT	TEF	BTUB
<i>Phycomyces</i> <sup>a</sup>	estExt_Genewise 1.C_340013	e_gw1.2.294.1	estExt_20134
<i>Physarum</i>	X07792	AF016243	M20191
<i>Phytophthora</i>	M59715	AJ249839	U22050
<i>Plasmodiophora</i>	AM411664	AM411655	AM411665
<i>Pythium</i>	X76725	DQ911417	AF218256
<i>Reticulomyxa</i>	AJ132374	EU810334	X96477
<i>Rhizopus</i> <sup>b</sup>	RO3G_14002.3	RO3G_15351.3	RO3G_06151.3
<i>Saccharomyces</i>	L00026	M10992	V01296
<i>Schizophyllum</i>	AF156157	X94913	X63372
<i>Smittium</i>	AY582840	AY582822	AY944829
<i>Sphaeroforma</i>	AJ780965	DQ403164	–
<i>Stephanopogon</i>	EF455777	FJ807246	EF455757
<i>Suillus</i>	AF155931	AY883429	AY112730
<i>Trichoderma</i>	X75421	Z23012	Z15054
<i>Trichomonas</i>	U63124	–	L05468
<i>Trypanosoma</i>	M20310	U10562	K02836
<i>Umbelopsis</i>	AJ287166	AF157258	AF162073
<i>Zea</i>	J01238	D45408	X52878
<i>Thermotoga</i>	NP_228398	M27479	U65944

<sup>a</sup>Genome projects at <http://genome.jgi-psf.org/>

<sup>b</sup>Genome project at <http://www.broadinstitute.org>

were reviewed by Kock and Botha (1998) and Frisvad et al. (2008). Because of the inconsistent quality throughout the zygomycetous fungi, no studies on fatty acids at higher taxonomic levels, from phylum to family, have been reported so far. But it is the very inconsistency that makes fatty acids so useful in lower rank's taxonomy. Therefore at or below genus level applying comparatively few numbers of isolates as representatives, fatty acids were proven to be a potential marker for identification and classification as different genera, subgenera, or even species that can exhibit distinctive profiles (Amano et al. 1992; Blomquist et al. 1992; Weete et al. 1998; Weete and Gandhi 1999; Batrakov et al. 2002, 2004). Moving on to the nucleotide and protein aspects, there are far more papers than on the previously mentioned characters. Using “Zygomycota” as inquiry, more than 5,000 references for literature can nowadays be retrieved from the National Center for Biotechnology Information ([www.ncbi.nlm.nih.gov](http://www.ncbi.nlm.nih.gov)) alone. This article will make an effort to give a sketchy review from such a considerably large number of publications on nucleic acids as well as proteins.

## 20.2 Molecular Characters for Classifying Zygomycetous Fungi

It usually tends to be called molecular phylogeny or equivalents when DNA data are used to identify and classify organisms because they are believed to contain original, genetic and evolutionary information. Most current DNA data



**Table 20.2** Comparison of traditional Zygomycota and current zygomycetous fungi

Hawksworth et al. (1995)	Kirk et al. (2001)	Hibbett et al. (2007)
ZYGOMYCOTA	ZYGOMYCOTA	GLOMEROMYCOTA
Zygomycetes	Zygomycetes	Glomeromycetes
1. Glomales	1. Geosiphonales 2. Glomales	1. Glomerales SUBPHYLAE INCERTAE SEDIS
2. Entomophthorales Basidiobolaceae	3. Entomophthorales 4. Basidiobolales	Entomophthoromycotina 1. Entomophthorales
3. Endogonales Mortierellaceae	5. Endogonales 6. Mortierellales	Mucoromycotina 1. Endogonales 2. Mortierellales
4. Mucorales	7. Mucorales	3. Mucorales
5. Zoopagales	8. Zoopagales	Zoopagomycotina 1. Zoopagales
6. Dimargaritales	9. Dimargaritales	Kickxellomycotina 1. Dimargaritales
7. Kickxellales	10. Kickxellales	2. Kickxellales
Trichomycetes	Trichomycetes	
1. Asellariales	1. Asellariales	3. Asellariales
2. Harpellales	2. Harpellales	4. Harpellales
3. Amoebidiales		
4. Eccrinales	3. Eccrinales	

from zygomycetous fungi have revealed that there is obviously a conflict between traditional morphology-based classification scheme and recent DNA-based phylogenetic one. Above the level of orders this inconsistency has led to a distribution of traditional Zygomycota among five clades, including Glomeromycota, Mucoromycotina, Kickxellomycotina, Entomophthoromycotina, and Zoopagomycotina (Hibbett et al. 2007).

From the comparison of the current zygomycetous fungi with the last two editions of Ainsworth and Bisby's Dictionary of the Fungi (Table 20.2), four major points of status changes at the order level can be observed.

### 20.2.1 *Amoebidiales and Eccrinales*

Eccrinales and Amoebidiales, sharing ecological niche — the arthropod gut with other orders of the class Trichomycetes, were thought to be members of this class (Lichtwardt 1986). At the same time there were lots of opposites concerning its affinity with Trichomycetes based on the lack of a septal pore and associated plug, the presence of dictyosomes (Moss 1999), the lack of chitin in their cell wall (Trotter and Whisler 1965), and the distant relationships in rDNA phylogenies (Benny and O'Donnell 2000; Ustinova et al. 2000; Mendoza et al. 2002; Cafaro 2005). Therefore they are now excluded from the zygomycetous fungi. However, both of the remaining orders of the former Trichomycetes, the Asellariales and the

Harpellales still remain among the zygomycetous fungi. Zygospores were reported in species of the Asellariales (Valle and Cafaro 2008). The Harpellales is phylogenetically closely related to the Kickxellales (Benny and O'Donnell 2000) and classified now to the Kickxellomycotina (Hibbett et al. 2007).

### 20.2.2 *Basidiobolales*

*Basidiobolus* was originally placed in the family Basidiobolaceae of the order Entomophthorales, then raised as a separate order Basidiobolales (Cavalier-Smith 1998) and later adopted (Kirk et al. 2001), and end up now as not being placed in any higher taxa. Why is that? *Basidiobolus* is currently the only genus of nonzoospore forming fungi known to have a nucleus-associated organelle that contain microtubules, suggesting a potential affinity between *Basidiobolus* and Chytridiomycota, although the structure of the microtubules is somewhat different (McKerracher and Heath 1985). In the phylogeny based on SSU rDNA, *Basidiobolus* did form a clade with many chytrids (James et al. 2000), whereas it was grouped with some Zygomycetes in phylogenies of alpha-tubulin and beta-tubulin and SSU rDNA (Nagahama et al. 1995; Jensen et al. 1998; Keeling et al. 2000; Keeling 2003) and nested in a clade consisting of major zygomycetous fungi in a stronger phylogeny of six genes (James et al. 2006). Based on ACT-BTUB-TEF protein phylogenies *Basidiobolus* appears to be paraphyletic to the Entomophthoromycotina, but with no statistical branch (BS) support (Fig. 20.1). Ultra structural and molecular characteristics congruously suggested that *Basidiobolus* might be a transitional organism between chytrids and zygomycetous fungi.

### 20.2.3 *Geosiphonales*

*Geosiphon* was initially only given an unassigned zygomycete position as a genus (Hawksworth et al. 1995), then became a member of Geomycetes (Ascomycota) (Cavalier-Smith 1998), and later returned to Zygomycetes but with a certain position of a separate order Geosiphonales (Kirk et al. 2001; Schüßler et al. 2001). In the current classification it is once more apart from the zygomycetous fungi and belongs to the Glomeromycota only reaching a level of family Geosiphonaceae (Hibbett et al. 2007; CABI\_BioScience and Research 2008). The reason for these remarkable changes in position is that *Geosiphon* is associated with cyanobacteria, so different from its related taxa in Glomeromycota, which are all symbionts of arbuscular mycorrhiza. This time it will be expected to stay more stably because a series of papers about the Glomeromycota always revealed a monophyly for the genus *Geosiphon* and other members of Glomeromycota as a whole, even if a polyphyletic feature among them has also been discovered on the basis of data from ribosomal RNA and some protein genes (Schüßler et al. 2001; Schüßler 2002; Redecker and Raab 2006; Walker et al. 2007).

### 20.2.4 *Mortierellales*

Mortierellales was established by Cavalier-Smith (1998) based on a traditional family Mortierellaceae in Mucorales, and this elevation in taxonomic status has been supported by different molecular data including *act*, EF-1 alpha, and SSU-ITS-LSU rRNA genes (Gehrig et al. 1996; Voigt and Wöstemeyer 2001; Lutzoni et al. 2004; Kwasna et al. 2006). While Hibbett et al. (2007) proposed the phylogenetic alliance of the Mortierellales with the Mucorales unified in the Mucoromycotina, Voigt et al. (2009) discovered a more derived phylogenetic relationship between the Mortierellales and the Endogonales, which deserves the erection of a new subphylum, the Mortierellomycotina ined.

### 20.2.5 *Mucorales*

In regard to families, the most remarkable studies are about the classification within the order Mucorales. The artificial or unnatural feature of the traditional family-level classification schemes for this order has been presented according to the analyses of SSU, LSU rDNA, EF-1 alpha, and actin gene sequences (O'Donnell et al. 2001; Voigt and Wöstemeyer 2001). Another gene, *rpb1*, was also proposed as an alternative marker for Mucorales phylogenetic studies (Tanabe et al. 2004). As a consequence of these data, G. L. Benny later integrated almost all families of Mucorales, except Umbelopsidaceae, into a single family Mucoraceae *sensu lato* (<http://www.zygomycetes.org/>), which was considered plausible (White et al. 2006). However, the recognition of families in ancient fungal lineages such as mucoralean and other terrestrial fungi is rather tedious. For a rough estimation of the origin and the radiation of mucoralean and allied fungi the following minimum ages for the divergence of major clades may be used: (1) 1,000 million years for the radiation of the major eukaryotic clades fungi, Metazoa and plants (Simon et al. 1993; Hightower and Meagher 1986), (2) the split of the Metazoa from the fungi 944–965 million years ago and (3) the divergence of Asco- and Basidiomycota 452–500 million years ago including (4) 440 million years for basidiomycete radiation and (5) 240 million years for radiation of the Pezizomycotina (for (2)–(5) see Berbee and Taylor 2001; Taylor and Berbee 2006). The standard procedure for molecular clocks is to plot averaged distances against time (Li and Graur 1999; Wang et al. 1999). Now exploiting the molecular clock-like and linear evolution of actin (Hightower and Meagher 1986; Berbee and Taylor 2001; Taylor and Berbee 2006) and other protein-coding genes commonly used for the assessment of evolutionary distances and phylogenetic trees (see Fig. 20.1 in this chapter; Fig. 2 in Voigt and Wöstemeyer 2001), the Mucorales may have already originated in the Late Cambrian, approximately 530 million years ago, and the origin of the Mortierellales dates to the Mid Devonian, 360 million years ago. Consequently, the origin of the Mortierellales coincides with the manifestation the arbuscular endomycorrhizal fungi (Glomeromycota) 353–462 million years ago (Simon et al. 1993;

Redecker et al 2000), whereas the Mucorales diverged as basal fungal lineage, possibly before the appearance of the first land plants, 360–480 million years ago (Simon et al. 1993; Hightower and Meagher 1986; Kenrick and Crane 1997; Berbee and Taylor 2001; Taylor and Berbee 2006). These data qualify the Mucorales as one of the earliest groups of recent land fungi on Earth, emerging before the availability of terrestrial plants as carbon source. Support of that estimation is gained by the putative localization of the radiation of the true fungi in the Early Paleozoic era, about 650–700 million years ago, which agrees well with previous estimates (Margulis 1981; Berbee and Taylor 2001; Taylor and Berbee 2006). It has to be emphasized that those rough calculations gained minimum ages, which fit well with fossil records (e.g., Redecker et al. 2000). Since fossil records define the time point of the manifestation of a certain taxon, the minimum ages may be underestimated. The suggestion of the ancient divergence between Glomeromycota from the Dikaryomycota (Asco- and Basidiomycota) 600 million years ago according to Redecker et al. (2000) strengthens that hypothesis. Therefore, it can be concluded that the Mucorales are more heterogenous and justify more than just two families. An attempt to revise the family structure of the Mucorales based on four-locus phylogenies is shown in Chaps. 11 (Fig. 11.4) and 19 (Fig. 19.1).

Besides these significant shifts about subphyla, orders and families resulted from modern molecular phylogenetic studies; there are some more emphases on different genera of zygomycetous fungi.

### 20.2.5.1 *Absidia*

*Absidia* spp. are filamentous fungi that are cosmopolitan and ubiquitous in nature as common environmental contaminants. They are found in plant debris and soil, as well as being isolated from foods and indoor air environment. They often cause food spoilage. It can transform steroids and produce rennin-like components, whereas some species are opportunistic human pathogens. *Absidia* is characterized by the branched and grouped sporangiophores carrying pyriform and relatively small sporangia, and arising on stolons from points between the rhizoids, but not opposite the rhizoids as in *Rhizopus*. Zygospores are formed on opposed, more or less equal suspensors adorned with several appendages. *Absidia* was divided into two parts: the subgenus *Absidia* in which the zygospores are surrounded by suspensor appendages and the subgenus *Mycocladius* in which suspensor appendages are not produced (Hesseltine and Ellis 1964). On investigating the phylogenetic relationships between 16 *Absidia* species based on *act* and ITS1-5.8S-ITS2 rDNA sequences, a trichotomy relevant to mesophilic, thermotolerant, and mycoparasitic groups was reconstructed, which is concordant with the morphology of the zygospores (Hoffmann et al. 2007). Furthermore based on the phylogenetic coherence of mesophilic and thermotolerant *Absidia* species, as well as other distinct characteristics in morphology, the two groups were separated into two distinct genera and placed in different family, *Absidia* (Absidiaceae) for the mesophilic species and *Mycocladius* (as “Mycocladaceae,” but orthographically correct

Mycocladales) for the thermotolerant species *A. corymbifera*, *A. blakesleeana* and *A. hyalospora* (Hoffmann et al. 2007). But the type of species of *Mycocladius*, *M. verticillatus* Beauverie was discovered to be a coculture between a mesophylic and a mycoparasitic species of the former *Absidia*, and thus, not congeneric with the other species of *Mycocladius*. Therefore, a new family was established for the thermotolerant *Absidia* spp., the Lichtheimiaceae typified with *Lichtheimia corymbifera* (Cohn) Vuill. (Hoffmann et al. 2009b). For a more detailed review on the classification and the identification of *Absidia* see Chap. 19.

#### 20.2.5.2 *Actinomucor*

*Actinomucor* has been used in the fermentation of sufu (Chinese cheese). Only two species, viz. *A. elegans* and *A. taiwanensis*, are generally accepted in this small genus. The former is widespread and has already been found in many countries, while the latter has been reported from China only. According to ITS rDNA and EF-1 alpha sequence data, *A. taiwanensis* was reduced to varietal rank under *A. elegans* as *A. elegans* var. *meitauzae* because *A. taiwanensis* is the same fungus as *Mucor meitauzae* which was published in 1937, before *A. taiwanensis* (Zheng and Liu 2005).

#### 20.2.5.3 *Cunninghamella*

*Cunninghamella* is a filamentous fungus found in soil, plant material, animal material, cheese, and Brazil nuts. In addition to being a common contaminant, it is an opportunistic fungus causing infections in immunocompromised hosts. *Cunninghamella* can transform pantoprazole and amoxapine and can also produce gamma-linolenic acid, chitin and chitosan. Classification of *Cunninghamella* has been based principally on morphology of the sporangial and zygosporic states, maximum growth temperature, mating compatibility and zygosporic formation. In addition, ITS rDNA sequences has been used as an important reference for species and variety delimitation, leading to the recognition of 12 species and three varieties within the genus (Liu et al. 2001).

#### 20.2.5.4 *Pilaira*

All members of Pilobolaceae are coprophilous and produce phototropic, almost unbranched sporangiophores, which arise directly from substrate and terminate in dark hemispheric columellate sporangia with persistent, cutinized walls. The genus *Pilaira* is characterized by the absence of trophocysts and subsporangial swellings, which are present in both *Pilobolus* and *Utharomyces*. Multigene phylogenetic analyses supported the presence of trophocysts and subsporangial swellings as synapomorphic characters by the separation of *Pilaira* from the core Pilobolaceae *sensu stricto* (Voigt et al. 2009). Nine of the ten species documented by Index

Fungorum of CABI Bioscience seem to be unique and have only been recorded once in literature, while *P. anomala* is ubiquitous in Europe and America and has been reported many times (Zheng and Liu 2009). Morphological studies have been conducted with all the available strains: six and 15 respectively from China and NRRL, resulting in recognition of five taxa including two new species and one new combination (Zheng and Liu 2009). Molecular phylogeny of 21 worldwide available strains of *Pilaira*, including two new species recently proposed from China, was reconstructed by using ITS rDNA and *pyrG* gene sequences (Liu et al. In press). The two loci displayed different phylogenetic histories. Besides some complete or partial concordances with morphology, several disagreements were found suggesting that this genus is dynamic in lineage splitting.

### 20.2.5.5 *Rhizomucor*

The genus *Rhizomucor* is ubiquitous and commonly found in soil, compost heaps, decaying fruit and vegetables. It produces highly efficient enzymes for flax retting, milk clotting and lignocellulose degeneration. It is often associated with animal diseases. As for human being, most species of *Rhizomucor* are opportunistic agents causing zygomycosis. For successful treatments, it is critical to quickly and accurately identify the pathogen and then promptly and precisely apply antimycotics. Morphologically, *Rhizomucor* is distinguished from *Mucor* by the presence of stolons and rhizoids. *Rhizomucor* hitherto comprises six species and one variety belonging to two groups by virtue of the maximum growth temperature, i.e., the thermophilic and the mesophilic species. All these taxa can be well delimited by distinct characteristics besides the maximum growth temperature, and the key to the species and varieties of *Rhizomucor* were provided by Zheng and Jiang (1995). It seems very easy to distinguish *Rhizomucor* taxa from one another according to numerous, stable, reliable and distinct morphological and physiochemical features. However, the practical determinations of *Rhizomucor* species based on morphological observations and sometimes physiochemical tests involve limitations, frequently resulting in inaccurate identifications (Lukács et al. 2004). Moreover recent molecular data have brought forth some new questions. The comparison of morphology-based and DNA-based identifications suggested that some prior reports concerning *R. pusillus* based on traditional methods might even represent other zygomycetous fungi, such as *Rhizopus* and *Mucor* (Iwen et al. 2005; Kontoyiannis et al. 2005). Different genes have shown different phylogenies for the members of *Rhizomucor*. Nuclear SSU rDNA sequence data have revealed that *Rhizomucor* were polyphyletic, with the thermophilic *R. miehei* and *R. pusillus* being a sister group of the clade of *Absidia corymbifera*, and the mesophilic *R. variabilis* being nested within the clade of seven species of *Mucor* (Voigt et al. 1999). The LSU rDNA sequences demonstrated another phylogenetic relationship between *Rhizomucor* spp. and other members of Mucorales, i.e., *R. miehei* and *R. pusillus* related next to *Syncephalastrum racemosum* rather than *A. corymbifera*, and *R. variabilis* formed a clade with two species of *Mucor*

instead of seven. Exhaustive ITS1-5.8S-ITS2 phylogenies and identity matrices revealed a close relationship between *R. variabilis* and *M. hiemalis* (Hoffmann et al. 2009a). The combined data of SSU, LSU rDNA and EF-1 alpha sequences showed that the species *R. pusillus* related more closely to *Thermomucor indicae-seudaticae* than to *S. racemosum* or *A. corymbifera* (O'Donnell et al. 2001). Beside these questions about *R. miehei*, *R. pusillus* and *R. variabilis*, the recognition of *R. tauricus* as a distinct species was doubted by some investigators based on isoenzyme patterns, ITS-RFLP, and RAPD (Vágvölgyi et al. 1999; Vastag et al. 2000). In order to solve the problems met in morphological and physiochemical identification, molecular relationships based on *cox1*, *cox2*, *cox3*, *pyrG*, and SSU+ITS1+5.8 S+ITS2 rDNA sequences, were analyzed with a result of dichotomy relevant to mesophilic and thermophilic groups (Liu and Zheng 2008).

### 20.2.5.6 *Rhizopus*

Members of *Rhizopus* are important as agents of food fermentation, agricultural and food spoilage, human mucormycosis, and industrial and medical biotechnology. They may occur as saprobes on plant debris, soil, and dung, or as air contaminants. *Rhizopus* is characterized by apophysate sporangia, stolons on aerial mycelia, and rhizoids developed from stolons and opposite sporangiophores. *Rhizopus* was divided into two groups (*R. microsporus* Group and *R. stolonifer* Group) and one species (*R. oryzae* Went & Prins. Geerl.) according to anamorphic morphology and growth temperature (Schipper 1984; Schipper and Stalpers 1984). A recent monographic study of this genus based on morphology, maximum growth temperature, mating compatibility, and molecular systematics has been conducted in which a total of 17 taxa including ten species and seven varieties were recognized from a global collection (Zheng et al. 2007). Concerning molecular studies on this genus, some taxa have been involved for aiming at the resolution of high-level phylogeny (Voigt et al. 1999; O'Donnell et al. 2001; Schwarz et al. 2006). ITS, 18S and 28S rDNA sequences were used to investigate the molecular phylogeny of this genus (Abe et al. 2003, 2006; Hoffmann et al. 2009a). For a more detailed review on the molecular ITS-based identification of *Rhizopus* and allied genera see Chap. 11. ITS rDNA and *pyrG* were also applied to support most of the morphological treatments made recently, including the rejection of the level of group between genus and species (Liu et al. 2007; Zheng et al. 2007). On the basis of nuclear ribosomal DNA sequence and *pyrG* data, the distant relationship between the two varieties of *R. stolonifer*, i.e., var. *lyococcus* and var. *stolonifer*, was observed but treated differently: not reclassifying these two taxa (Abe et al. 2006), modifying the taxonomical scheme of Schipper et al. with a new combination *R. lyococcus* (Liou et al. 2007), or *R. lyococcus* being recognized as a synonym of *R. reflexus* (Liu et al. 2007; Zheng et al. 2007). As for those varieties within *R. arrhizus* and *R. microsporus*, IGS rDNA, especially the short tandem repeat motifs, was found to be very useful for variety delimitation (Liu et al. 2008). The fumaric-malic acid



producer group of *R. arrhizae* was raised to a species level as *R. delemar*, differing from the lactic acid producer group and confirmed by analyses of ITS rDNA, lactate dehydrogenase B, actin, translation elongation factor-1alpha and AFLP (Amplified Fragment Length Polymorphism) (Abe et al. 2007).

Thus, it is obvious that molecular studies mostly paid attention to those issues that have long been questioned by traditional methods and actually addressed many, if not all. Therefore the molecular data were proven to be a very important part of the characters of zygomycetous fungi, not a separate and independent aspect. Among these molecular markers, genes and spacers of ribosomal RNA are most investigated, due to their universal primers, suitable fragment length and moderate variation speed.

## 20.3 Molecular Characters in Industrial Zygomycetous Fungi

It is well-known that there are many products from zygomycetous fungi playing an important role in industry, such as glucoamylase, polygalacturonase, fumaric acid and polyunsaturated fatty acids (PUFAs). In addition to identification and classification, this article will also touch on topics of molecular characters in industrial fields.

### 20.3.1 *Glucoamylase*

Glucoamylase from *Rhizopus arrhizus* has long been of considerable importance to the fermentation and food industries for saccharification of starch/amylopectin to alcohol. Many commercial glucoamylase enzyme preparations are derived from *Rhizopus* owing to their nearly complete conversion of starch to glucose. Glucoamylase has been isolated and characterized from a number of *Rhizopus* species (Mertens and Skory 2007a, b).

### 20.3.2 *Polygalacturonase*

Flax has widely been used in textiles, high quality papers and composites. Retting is one of the greatest problems in flax fiber production. Water-retting and dew-retting were used in the past but are discarded nowadays due to different disadvantages such as pollution and weather dependency. Alternative ideas for retting have been developed, such as chemical retting using chelating agents and enzymatic retting using suitable enzyme mixtures. The latter technique results in cleaner fibers of higher and more consistent quality. The retting efficiency varied considerably between different organisms. *Rhizopus oryzae* (= *R. arrhizus*) produced extracellular enzymes that could independently degrade the middle lamella. This zygomycete



is an ideal model system for studying the mechanisms of enzymatic retting of flax. An extracellular polygalacturonase is probably the key component in the retting system of *R. oryzae*. It was purified and characterized. The purified enzyme has a molecular mass of 37,436 Da from mass spectrometric determination, an isoelectric point of 8.4, and has nonmethylated polygalacturonic acid as its preferred substrate. Peptide sequences indicate that the enzyme belongs to family 28, in similarity with other polygalacturonases. It contains, however an N-terminal sequence absent in other fungal pectinases, but present in an enzyme from the phytopathogenic bacterium *Ralstonia solanacearum* (Zhang et al. 2005). Besides *R. oryzae*, other well-known zygomycetous fungus producing flax-retting enzymes is *Rhizomucor pusillus* (Henriksson et al. 1999).

### 20.3.3 Fumaric Acids

Fumaric acid is a naturally occurring organic acid. Many microorganisms produce fumaric acid in small amounts, as it is a key intermediate in the citrate cycle. Currently, fumaric acid is produced chemically from maleic anhydride. However, as petroleum prices are rising rather quickly, maleic anhydride as a petroleum derivative has increased in price as well. This situation has caused a renewed interest in the fumaric acid production by fermentation. Zygomycetous fungi, including *Rhizopus*, *Mucor*, *Cunninghamella*, and *Circinella* species, are well-known for their organic acid-producing capability and have been used in fermentation processes for fumaric acid production (Roa Engel et al. 2008). Among these strains, *R. arrhizus* is the best-producing one. According to the analyses of, ITS rDNA, lactate dehydrogenase B, actin, translation elongation factor-1alpha, genome-wide AFLP, and organic acid production as well, *R. arrhizus* var. *delemar* (= *R. delemar*) was thought to be the proper name for *R. arrhizus* fumaric-malic acid producers (Abe et al. 2007). To date there is no report about the sequencing, cloning and characterization of enzymes relevant to metabolic pathways of fumaric acid.

### 20.3.4 Polyunsaturated Fatty Acids

Polyunsaturated fatty acids play important roles as structural components of membrane phospholipids and as precursors of the eicosanoids of signaling molecules. All mammals synthesize such eicosanoids, which are involved in inflammatory responses, reproductive function, immune responses and regulation of blood pressure. Arachidonic acid (AA; 20:4n-6), as a representative n-6 PUFA, is the most abundant 20-carbon PUFA in humans; and it not only exhibits various regulation effects and physiological activities but also plays important roles in infant nutrition.

Eicosapentaenoic acid (EPA; 20:5 $n$ -3), as a representative  $n$ -3 PUFA, is beneficial for cardiovascular diseases and decreases platelet aggregation and blood pressure. The distinct functions of the two families make the ratio in the diet of  $n$ -6 and  $n$ -3 PUFAs important for inflammatory responses and cardiovascular health. *Mortierella alpina* 1S-4 can produce EPA through the  $n$ -3 PUFA biosynthetic pathway and AA through the  $n$ -6 PUFA biosynthetic pathway. Therefore, this fungus is a good model for analyzing a fatty acid desaturation system from both fundamental and applied viewpoints. The genes encoding  $\omega$ 3-desaturase, the  $\Delta$ 9-desaturases,  $\Delta$ 12-desaturases,  $\Delta$ 6-desaturases and  $\Delta$ 5-desaturases involved in 20-carbon PUFA biosynthesis have been cloned from *M. alpina* 1S-4 (Sakuradani et al. 1999a, b, c, 2005; Sakuradani and Shimizu 2003).

## 20.4 Molecular Characters in Medical Zygomycetous Fungi

Another important area of studies on zygomycetous fungi is medicine. Zygomycosis is a rare and opportunistic infection caused by fungi belonging to zygomycetous fungi. This type of invasive infections, both superficial and angioinvasive, is major medical complications in immunocompromised patients. Zygomycosis is frequently lethal if it is not detected early and treated only with high doses of amphotericin B, which is currently the main effective therapy for zygomycosis fungi but limited by severe nephrotoxic side effects. Mortality rates may be as high as 80% in infected transplant recipients. The recent rise in AIDS, cancer, diabetes, leukemia, lymphoma, solid organ or bone marrow transplants, immunosuppressive therapy, and broad-spectrum antimicrobial drugs, has increased the number of immunosuppressed and immunocompromised patients. Although *Aspergillus* and *Candida* are generally two most commonly infected agents in such patients, zygomycosis has increased significantly over the past decade. Zygomycetous fungi are now listed by hospitals as microorganisms responsible for frequent emerging infections (Chayakulkeeree et al. 2006).

Due to its acute and rapid development, the prompt and precise identification of a pathogen becomes very crucial for appropriate and efficient treatments to decrease its mortality. Zygomycosis can be subdivided into mucoromycosis and entomophthoromycosis which are caused by members of the order Mucorales and Entomophthorales, respectively. Pathogenic Mucorales comprises the following ten genera: *Absidia*, *Apophysomyces*, *Cokeromyces*, *Cunninghamella*, *Mortierella*, *Mucor*, *Rhizomucor*, *Rhizopus*, *Saksenaia*, and *Syncephalastrum*. Among these, *Absidia*, *Mucor*, *Rhizomucor*, and *Rhizopus* are four most common isolated pathogens. Medical Entomophthorales only includes *Conidiobolus* and *Basidiobolus*. Histopathological examination of the tissues typically shows characteristic broad, hyaline, ribbon-like, wide-angled branching, pauciseptate irregular fungal hyphae (mucoromycosis), or shows broad fungal hyphae with sparsely found septum surrounded by eosinophilic granular material (entomophthoromycosis). Their morphological characteristics are so reduced that it is impossible to distinguish them

only by histopathological examination. It is quite easy to differentiate them by sporangia and other reproductive features after pure cultivation. However, it has not been widely adopted to diagnose agents through detailed morphological characteristics due to notorious difficulties in axenic culture from clinical specimens because hyphal elements may be rare in tissue specimens and they can lose their viability during the tissue homogenization prior to culturing. In addition, Antifungal susceptibility and serological tests usually cannot get accurate and consistent endpoints and consequently are not available for routine use.

The poor sensitivity of histological practices, the difficult pure cultivation, and the inaccurate susceptibility and serological tests, have led to the development of highly sensitive and specific molecular techniques, such as microsatellite, oligonucleotide probes, array, fluorescent capillary electrophoresis, real-time PCR, PCR-restriction fragment length polymorphism (PCR-RFLP), random amplified polymorphic DNA (RAPD), pulsed field gel electrophoresis (PFGE), and direct sequencing of PCR products. These methods targeted either a single gene or a whole genome.

#### **20.4.1 SSU/LSU rDNA**

Numerous targets within the fungal genome have been evaluated, with much of the current work using areas within the ribosomal RNA gene (rDNA) complex, especially SSU and LSU rDNA. A molecular database for 42 isolates representing all clinically important zygomycetous fungi was constructed from the SSU and LSU rDNA. And 13 taxon-specific PCR primers were designed for those taxa most commonly encountered in infections, according to the aligned LSU rDNA sequences, which was suggested to have the potential to be used in the PCR assay for rapid and accurate identification of the etiological zygomycoses (Voigt et al. 1999). A case, in which proven invasive infection caused by *Cunninghamella bertholletiae* was confirmed by a pan-fungal PCR assay using conserved primers binding to SSU rDNA and a specific biotin-labeled probe, was reported. However, because of the relatively high conservation of SSU rDNA, the probe can detect DNA not only from *C. bertholletiae* but also from *Absidia glauca*, *C. elegans* and *C. polymorpha* (Rickerts et al. 2001). Other cases caused by *C. bertholletiae*, however, were also reported not by simple probes but through direct DNA sequencing of the PCR products from serial serum samples (Kobayashi et al. 2004; Makoto 2004). A set of oligonucleotide probes based on SSU rDNA sequencing for the detection of common airborne or pathogenic fungi at the genus and species levels, including some zygomycetous organisms, was developed (Wu et al. 2003). The MicroSeq D2 large-subunit ribosomal DNA sequencing kit was used to detect filamentous fungi, but did not obtain a high rate of accurate identification among the zygomycetous fungi, and consequently suggested an additional work to determine which gene or combination of genes is needed for complete separation of genera and species (Hall et al. 2004). Additionally, a review paper highlighted the

discordance between conventional phenotypic characterization and identification using this kit (Greenberg et al. 2004).

### 20.4.2 ITS rDNA

The ITS rDNA has also been widely used as targets to detect and identify human fungal pathogens. It plays a critical role in the development of functional rRNA, with sequence variations among species showing promise as signature regions for molecular assays. A rapid identification of fungi was recommended by using the ITS2 rDNA region and an automated fluorescent capillary electrophoresis system, which was thought to be a promising tool for the rapid diagnosis of invasive fungal infections, including zygomycosis (Turenne et al. 1999). The whole ITS rDNA was used as the basis of multiplex PCR by which human pathogenic *Rhizopus* species was genetically identified and detected (Nagao et al. 2005) and as the basis of an oligonucleotide array, which was developed to identify species of clinically important filamentous or dimorphic fungi (Hsiao et al. 2005). The multiplex ITS-PCR method provided a rapid, simple, and reliable alternative to conventional methods to identify common clinical fungal isolates, based on the testing pathogenic fungi directly from cultures with 100% sensitivity and specificity (Luo and Mitchell 2002). PCR-RFLP method, another molecular biology tool concerning ITS rDNA, was developed to identify the main Mucorales belonging to the genera *Absidia*, *Mucor*, *Rhizopus*, and *Rhizomucor* involved in human pathology at genus and species level (Machouart et al. 2006). The analysis of ITS rDNA sequences was validated as a reliable technique for identification of zygomycetous fungi to the species level by using 54 strains belonging to 16 species, including the most common pathogenic *Rhizopus*, *Absidia*, *Mucor*, and *Rhizomucor* (Schwarz et al. 2006; Hoffmann et al. 2009a). Among the genus *Cunninghamella*, *C. bertholletiae* has long been considered the only agent in human diseases, but recently *Cunninghamella echinulata* has been identified as another agent based on the result of the ITS rDNA sequences of isolates of *C. bertholletiae*, which are highly homologous and are distinct from those of *C. echinulata* (Liu et al. 2001; Lemmer et al. 2002). However, it is also mentioned that the number of organisms, which could be amplified directly from mycelial fragments is relatively low, only about 50% (Luo and Mitchell 2002).

### 20.4.3 Cytochrome b Gene

Besides different regions and spacers of ribosomal RNA genes, other genes are also occasionally used to differentiate zygomycetous pathogens. For example, real-time PCR assay was developed by using probes binding to a 167-bp conserved region of the multicopy zygomycete cytochrome b gene, to detect species of the genera *Absidia*, *Apophysomyces*, *Cunninghamella*, *Mucor*, *Rhizopus*, and *Saksenaia* in

culture and tissue samples. Based on the high sensitivity and specificity from various materials, it is concluded that the real-time PCR assay was useful for the rapid and accurate detection of zygomycetous fungi (Hata et al. 2008).

#### 20.4.4 Whole-Genome Fingerprinting and Genotyping

The microsatellite DNA fingerprinting confirmed the proposal of the new pathogen of *C. echinulata* (Lemmer et al. 2002) and the interstrain polymorphism of *Apo-physomyces elegans* was examined by using microsatellite primers with the results of two groups according to their patterns (Chakrabarti et al. 2003).

RAPD (Randomly Amplified Polymorphic DNA) analysis is also able to provide reproducible markers for strain identification. RAPD analysis of *Rhizomucor* strains showed *R. miehei* to be genetically more homogeneous than the diverse *R. pusillus*. RAPD markers described in these works could be utilized in further studies to identify clinical and environmental isolates of *R. miehei* and *R. pusillus* and to check the accuracy of the original species identifications (Vastag et al. 2000). The intraspecies variability of *Rhizopus stolonifer* and *R. oryzae* (= *R. arrhizus*) species was also examined by the RAPD method (Vágvölgyi et al. 2004). Although only a few *R. oryzae* strains were involved in that study, the RAPD analysis appeared to support the unity of the species *R. oryzae*, which was established with the incorporation of about 30 strains originally described as independent species.

PFGE (Pulsed Field Gel Electrophoresis) is also a versatile tool for molecular typing and to reveal the genetic variability at species and intraspecies levels. The electrophoretic karyotypes of *A. glauca* strains, have been revealed by rotating field gel electrophoresis and the sexually compatible strains of the mating type pair *A. glauca* showed considerable differences in their electrophoretic karyotype (Kayser and Wöstemeyer 1991); While those of *Mucor circinelloides* f. *lusitanicus* strains were generated by contour-clamped homogeneous electric field gel-electrophoresis and most showed polymorphisms with a different main karyotype pattern correlated with each mating type. (Díaz-Mínguez et al. 1999). Further possibilities to elucidate fingerprints and genotypes are AFLP (Amplified Fragment Length Polymorphism), RFLP (Restriction Fragment Length Polymorphism), PCR-RFLP and microsatellite PCR (Vastag et al. 2000; Vágvölgyi et al 2004).

#### 20.4.5 Carbon Assimilation Profiles

In addition to the methods for investigating different genes and whole genome, carbon assimilation profiles are sometime adopted to determine agents of zygomycosis. Fifty seven strains belonging to 15 species and varieties of zygomycetous fungi, including the genera *Rhizopus*, *Absidia*, *Mucor*, and *Rhizomucor*, was tested for intraspecies and interspecies variability based on their carbon assimilation profiles. It was concluded that the clustering of isolates based on their carbon

assimilation profiles was in accordance with DNA-based phylogeny of zygomycetous fungi and the carbon assimilation profiles allowed precise and accurate identification of most zygomycetous fungi to the species level (Schwarz et al. 2007).

Except the previously reviewed published studies, there are also many researches in which most infections are identified just as zygomycosis without any species determination (Ribes et al. 2000; Eucker et al. 2001). Nevertheless, the direct DNA sequencing of the PCR products obtained from pan-fungal primers remains the most reliable way to precisely identify zygomycetous fungi, even to a species level. But molecular techniques for detection of zygomycetous fungi by PCR or other methods are not widely available and are reserved primarily for research purposes. New techniques in the molecular identification of zygomycetous fungi need to be further developed and validated before they are used in clinical practice.

## 20.5 Genome Projects for Zygomycetous Fungi

The genome projects relevant to zygomycetous fungi are far less than those for Ascomycota and Basidiomycota, with a total of five species, namely *Mortierella verticillata*, *Mucor circinelloides*, *Phycomyces blakesleeanus*, *Rhizopus oryzae* (= *Rhizopus arrizus*), and *Smittium culisetae* (Table 20.3). The *R. oryzae* genome is the first zygomycetous fungus to be sequenced and now has been assembled, annotated, mapped, and released to public. Its mitochondrial sequence was assembled separately from the genomic one ([www.broad.mit.edu/annotation/genome/rhizopus\\_oryzae/MultiHome.html](http://www.broad.mit.edu/annotation/genome/rhizopus_oryzae/MultiHome.html)). Mitochondrial genome of another strain of *R. oryzae* has also been accomplished ([www.ncbi.nlm.nih.gov/sites/entrez?db=genomeprj&cmd=Retrieve&dopt=Overview&list\\_uids=13352](http://www.ncbi.nlm.nih.gov/sites/entrez?db=genomeprj&cmd=Retrieve&dopt=Overview&list_uids=13352); Seif et al. 2005). The mitochondrial genomes of two other zygomycetous fungi are also determined (Seif et al. 2005), that is, *M. verticillata* for which the genome sequencing is in progress ([www.broad.mit.edu/node/575](http://www.broad.mit.edu/node/575)), and *S. culisetae*. The *M. circinelloides* genome assembly was completed and is prerelease annotating ([mucorgen.um.es/](http://mucorgen.um.es/)), while the genome of *P. blakesleeanus* was released ([genome.jgi-psf.org/Phyb11/Phyb11.home.html](http://genome.jgi-psf.org/Phyb11/Phyb11.home.html)).

**Table 20.3** Genome statistics for zygomycetous fungi (N/A, not available)

Taxa	Isolates	Nuclei			Mitochondrion		
		Sizes (Mb)	GC (%)	Genes	Sizes (kb)	GC (%)	Genes
<i>Mortierella verticillata</i>	NRRL 6337	N/A	N/A	N/A	58.745	27.9	54
<i>Mucor circinelloides</i>	CBS 277.49	36.05	N/A	N/A	N/A	N/A	N/A
<i>Phycomyces blakesleeanus</i>	N/A	55.9	N/A	14792	N/A	N/A	N/A
<i>Rhizopus oryzae</i>	RA 99–880	46.09	35.6	17713	61.76	26.36	19
	DAOM 148428	N/A	N/A	N/A	54.178	26.2	51
<i>Smittium culisetae</i>	18–3	N/A	N/A	N/A	58.654	18.5	61

These zygomycetous fungi which have been selected as material for genome programs are all of certain importance. For example, *Mucor circinelloides* is a model system for *Agrobacterium tumefaciens*-mediated transformation (Nyilasi et al. 2005); *Phycomyces blakesleeanus* is also a model system not only for sensory physiology, but also for the regulation of the biosynthesis of the pigment beta-carotene in fungi as well; And *Rhizopus oryzae* (= *R. arrhizus*) is the most important and representative agent of mucormycosis.

## 20.6 Prospect

Zygomycetous fungi are usually distinguished mainly on numerous morphological traits. When the circumscription of certain taxa was controversial, other characters were called on as an auxiliary measure, including molecular ones. The morphological characters are undoubtedly the core of taxonomy of zygomycetous fungi either the past, the present or the future. On the other hand, further works on molecular characters of the zygomycetous fungi will expectably continue to increase, especially for those fungi that play a crucial role in medicine, agriculture and industry. To resolve the pending phylogenetic relationships among zygomycetous fungi based on more loci and more comprehensive samplings, will continue to be an important research advance at higher ranks like phylum, class and family. Meanwhile, at relatively low levels such as genus and species, on the basis of evaluation of suitable molecular markers, thoroughly and rationally integrating morphological and molecular characters for the identification and classification of zygomycetous fungi and even all cellular organisms is definitely an unchangeable trend, as already taken on in the effort to establish a worldwide organism barcode system (International Barcode of Life at [www.dnabarcoding.org](http://www.dnabarcoding.org), and Consortium for the Barcode of Life at [barcoding.si.edu](http://barcoding.si.edu)). Alternative genes, such as the single copy genes *Mcm7* (MS456) and *Tsr1* (MS277) useful for both phylogenetics and systematics (Aguileta et al. 2008, Schmitt et al. 2009) will circumvent designation problems triggered by paralogies of multicopied protein-coding genes or highly repetitive ribosomal DNA and revolutionize the molecular identification of fungi and the zygomycetes. It is most likely in the near future to establish a worldwide collaborative system for fungal identification serving all fungal research communities and individuals, on the basis of tremendous web resources, such as Assembling the Fungal Tree of Life ([aftol.org](http://aftol.org)), Barcode of Life Data Systems ([www.barcodinglife.org](http://www.barcodinglife.org)), GenBank ([www.ncbi.nlm.nih.gov](http://www.ncbi.nlm.nih.gov)), Global Biodiversity Information Faculty ([www.gbif.org](http://www.gbif.org)), Index Fungorum ([www.indexfungorum.org](http://www.indexfungorum.org)), MycoBank ([www.mycobank.org](http://www.mycobank.org)), etc. With the spurt in sequencing technology, more and more important zygomycetous fungi are hopeful of next candidates for genome projects, following the five completed representatives. The genome projects about some industrially, agriculturally, medically and environmentally important zygomycetous fungi are bound to provide a better understanding for their natural status in the whole organism system in the world and their potential to serve the human being.



## References

- Abe A, Oda Y, Asano K, Sone T (2006) The molecular phylogeny of the genus *Rhizopus* based on rDNA sequences. *Biosci Biotechnol Biochem* 70:2387–2393
- Abe A, Oda Y, Asano K, Sone T (2007) *Rhizopus delemar* is the proper name for *Rhizopus oryzae* fumaric-malic acid producers. *Mycologia* 99:714–722
- Abe A, Sone T, Sujaya IN, Saito K, Oda Y, Asano K, Tomita F (2003) rDNA ITS sequence of *Rhizopus oryzae*: its application to classification and identification of lactic acid producers. *Biosci Biotechnol Biochem* 67:1725–1731
- Aguilera G, Marthey S, Chiapello H, Lebrun MH, Rodolphe F, Fournier E, Gendrault-Jacquemard A, Giraud T (2008) Assessing the performance of single-copy genes for recovering robust phylogenies. *Syst Biol* 57:613–627
- Amano N, Shinmen Y, Akimoto K, Kawashima H, Amachi T, SS YH (1992) Chemotaxonomic significance of fatty acid composition in the genus *Mortierella* (Zygomycetes, Mortierellaceae). *Mycotaxon* 44:257–265
- Batrakov SG, Konova IV, Sheichenko VI, Esipov SE, Galanina LA, Istratova LN (2002) Unusual fatty acid composition of cerebrosides from the filamentous soil fungus *Mortierella alpina*. *Chem Phys Lipids* 117:45–51
- Batrakov SG, Konova IV, Sheichenko VI, Esipov SE, Galanina LA, Istratova LN, Sergeeva YE (2004) Lipids of the zygomycete *Absidia corymbifera* F-965. *Phytochemistry* 65:1239–1246
- Benjamin RK (1959) The merosporangiferous Mucorales. *Aliso* 4:321–433
- Benjamin RK (1966) The merosporangium. *Mycologia* 58:1–42
- Benjamin RK (1979) Zygomycetes and their spores. In: Kendrick B (ed) *The whole fungus the sexual-asexual synthesis*. National Museum of Natural Science, National Museums of Canada and the Kananaskis Foundation, Ottawa, Canada, pp 573–616
- Benny GL (1982) Zygomycetes. In: Parker SP (ed) *Synopsis and classification of living organisms*, vol I. McGraw-Hill Book Company, New York, USA, pp 184–195
- Benny GL, Humber RA, Morton JB (2001) The Zygomycota: Zygomycetes. In: McLaughlin DJ, McLaughlin EG, Lemke PA (eds) *The Mycota. Systematics and Evolution*, vol 7A. Springer, Berlin, pp 113–146
- Benny GL, O'Donnell K (2000) *Amoebidium parasiticum* is a protozoan, not a Trichomycete. *Mycologia* 92:1133–1137
- Berbee ML, Taylor JW (2001) Fungal molecular evolution: gene trees and geologic time. In: McLaughlin DJ, McLaughlin EG, Lemke PA (Eds.) *The Mycota vol. VII Part B Systematics and Evolution* (Esser K, Lemke PA, eds.). Springer, Berlin, pp 229–245
- Blomquist G, Anderson B, Anderson K, Bronz I (1992) Analysis of fatty acids. A new method for characterization of moulds. *J Microbiol Methods* 16:59–68
- CABI\_BioScience, CBS, Research L (2008) CABI Databases. At <http://www.indexfungorum.org/Names/fundic.asp>. Accessed 25 Dec. 2008
- Cafaro MJ (2005) Eccrinales (Trichomycetes) are not fungi, but a clade of protists at the early divergence of animals and fungi. *Mol Phylogenet Evol* 35:21–34
- Cavalier-Smith T (1998) A revised six-kingdom system of life. *Biol Rev* 73:203–266
- Chakrabarti A, Ghosh A, Prasad GS, David JK, Gupta S, Das A, Sakhuja V, Panda NK, Singh SK, Das S, Chakrabarti T (2003) *Apophysomyces elegans*: an emerging zygomycete in India. *J Clin Microbiol* 41:783–788
- Chayakulkeeree M, Ghannoum MA, Perfect JR (2006) Zygomycosis: the re-emerging fungal infection. *Eur J Clin Microbiol Infect Dis* 25:215–229
- Díaz-Mínguez JM, López-Matas MA, Eslava AP (1999) Complementary mating types of *Mucor circinelloides* show electrophoretic karyotype heterogeneity. *Curr Genet* 36:383–389
- Eucker J, Sezer O, Graf B, Possinger K (2001) Mucormycoses. *Mycoses* 44:253–260
- Felsenstein J (1985) Confidence limits of phylogenies: an approach using the bootstrap. *Evolution* 39:783–791



- Forget L, Ustinova J, Wang Z, Huss VAR, Lang BF (2002) *Hyaloraphidium curvatum*: a linear mitochondrial genome, tRNA editing, and an evolutionary link to lower fungi. *Mol Biol Evol* 19:310–319
- Frisvad JC, Andersen B, Thrane U (2008) The use of secondary metabolite profiling in chemotaxonomy of filamentous fungi. *Mycol Res* 112:231–240
- Gams W (1977) A key to the species of *Mortierella*. *Persoonia* 9:381–391
- Gehrig H, Schussler A, Kluge M (1996) *Geosiphon pyriforme*, a fungus forming endocytobiosis with *Nostoc* (cyanobacteria), is an ancestral member of the Glomales: evidence by SSU rRNA analysis. *J Mol Evol* 43:71–81
- Gill EE, Fast NM (2006) Assessing the *Microsporidia*-fungi relationship: combined phylogenetic analysis of eight genes. *Gene* 375:103–109
- Greenberg RN, Scott LJ, Vaughn HH, Ribes JA (2004) Zygomycosis (mucormycosis): emerging clinical importance and new treatments. *Curr Opin Infect Dis* 17:517–225
- Hall L, Wohlfiehl S, Roberts GD (2004) Experience with the MicroSeq D2 large-subunit ribosomal DNA sequencing kit for identification of filamentous fungi encountered in the clinical laboratory. *J Clin Microbiol* 42:622–626
- Hata DJ, Buckwalter SP, Pritt BS, Roberts GD, Wengenack NL (2008) Real-time PCR method for detection of Zygomycetes. *J Clin Microbiol* 46:2353–2358
- Hawksworth DL, Kirk PM, Sutton BC, Pegler DN (1995) *Ainsworth and Bisby's dictionary of the Fungi*, 8th edn. International Mycological Institute, CAB International, Wallingford, Oxon, UK
- Henriksson G, Akin DE, Slomczynski D, Eriksson KE (1999) Production of highly efficient enzymes for flax retting by *Rhizomucor pusillus*. *J Biotechnol* 68:115–123
- Hesseltine CW, Ellis JJ (1964) The genus *Absidia*: *Gongronella* and cylindrical-spored species of *Absidia*. *Mycologia* 56:568–601
- Hesseltine CW, Ellis JJ (1973) Mucorales. In: Ainsworth GC, Sparrow FK, Sussman AS (eds) *The fungi*, vol 4b. Academic Press, New York, USA, pp 187–217
- Hibbett DS, Binder M, Bischoff JF, Blackwell M, Cannon PF, Eriksson OE, Huhndorf S, James T, Kirk PM, Lucking R, Thorsten LH, Lutzoni F, Matheny PB, McLaughlin DJ, Powell MJ, Redhead S, Schoch CL, Spatafora JW, Stalpers JA, Vilgalys R, Aime MC, Aptroot A, Bauer R, Begerow D, Benny GL, Castlebury LA, Crous PW, Dai YC, Gams W, Geiser DM, Griffith GW, Gueidan C, Hawksworth DL, Hestmark G, Hosaka K, Humber RA, Hyde KD, Ironside JE, Koljalg U, Kurtzman CP, Larsson KH, Lichtwardt R, Longcore J, Miadlikowska J, Miller A, Moncalvo JM, Mozley-Standridge S, Oberwinkler F, Parmasto E, Reeb V, Rogers JD, Roux C, Ryvarden L, Sampaio JP, Schussler A, Sugiyama J, Thorn RG, Tibell L, Untereiner WA, Walker C, Wang Z, Weir A, Weiss M, White MM, Winka K, Yao YJ, Zhang N (2007) A higher-level phylogenetic classification of the fungi. *Mycol Res* 111:509–547
- Hightower RC, Meagher RB (1986) The molecular evolution of actin. *Genetics* 114:315–332
- Higgins DG, Sharp PM (1988) CLUSTAL: a package for performing multiple sequence alignment on a microcomputer. *Gene* 73:237–244
- Higgins DG, Sharp PM (1989) Fast and sensitive multiple sequence alignments on a microcomputer. *Comput Appl Biosci* 5:151–153
- Hoffmann K, Discher S, Voigt K (2007) Revision of the genus *Absidia* (Mucorales, Zygomycetes) based on physiological, phylogenetic, and morphological characters; thermotolerant *Absidia* spp. form a coherent group, the Mycocladiaceae fam. nov. *Mycol Res* 111:1169–1183
- Hoffmann K, Telle S, Walther G, Eckart M, Kirchmair M, Prillinger H, Prazanica A, Newcombe G, Dölz F, Papp T, Vágvölgyi C, deHoog S, Olsson L, Voigt K (2009a) Diversity, genotypic identification, ultrastructural and phylogenetic characterization of zygomycetes from different ecological habitats and climatic regions: limitations and utility of nuclear ribosomal DNA barcode markers. In: Gherbawy Y, Mach RL, Rai M (eds) *Current advances in molecular mycology*. Nova Science Publishers, Inc, New York, pp 263–312

- Hoffmann K, Walther G, Voigt K (2009b) *Mycocladus* vs *Lichtheimia*: a correction (Lichtheimiaceae fam. nov., Mucorales, Mucoromycotina). *Mycol Res* 113:277–278
- Hsiao CR, Huang L, Bouchara JP, Barton R, Li HC, Chang TC (2005) Identification of medically important molds by an oligonucleotide array. *J Clin Microbiol* 43:3760–3768
- Humber RA (1989) Synopsis of a revised classification for the Entomophthorales (Zygomycotina). *Mycotaxon* 34:441–460
- Iwen PC, Freifeld AG, Sigler L, Tarantolo SR (2005) Molecular identification of *Rhizomucor pusillus* as a cause of sinus-orbital zygomycosis in a patient with acute myelogenous leukemia. *J Clin Microbiol* 43:5819–5821
- James TY, Kauff F, Schoch CL, Matheny PB, Hofstetter V, Cox CJ, Celio G, Gueidan C, Fraker E, Miadlikowska J, Lumbsch HT, Rauhut A, Reeb V, Arnold AE, Amtoft A, Stajich JE, Hosaka K, Sung GH, Johnson D, O'Rourke B, Crockett M, Binder M, Curtis JM, Slot JC, Wang Z, Wilson AW, Schuszler A, Longcore JE, O'Donnell K, Mozley-Standridge S, Porter D, Letcher PM, Powell MJ, Taylor JW, White MM, Griffith GW, Davies DR, Humber RA, Morton JB, Sugiyama J, Rossmann AY, Rogers JD, Pfister DH, Hewitt D, Hansen K, Hambleton S, Shoemaker RA, Kohlmeyer J, Volkmann-Kohlmeyer B, Spotts RA, Serdani M, Crous PW, Hughes KW, Matsuura K, Langer E, Langer G, Untereiner WA, Lucking R, Budel B, Geiser DM, Aptroot A, Diederich P, Schmitt I, Schultz M, Yah R, Hibbett DS, Lutzoni F, McLaughlin DJ, Spatafora JW, Vilgalys R (2006) Reconstructing the early evolution of Fungi using a six-gene phylogeny. *Nature* 443:818–822
- James TY, Porter D, Leander CA, Vilgalys R, Longcore JE (2000) Molecular phylogenetics of the Chytridiomycota supports the utility of ultrastructural data in chytrid systematics. *Can J Bot* 78:336–350
- Jensen AB, Gargas A, Eilenberg J, Rosendahl S (1998) Relationships of the insect-pathogenic order Entomophthorales (Zygomycota, Fungi) based on phylogenetic analyses of nuclear small subunit ribosomal DNA sequences (SSU rDNA). *Fungal Genet Biol* 24:325–334
- Kayser T, Wöstemeyer J (1991) Electrophoretic karyotype of the zygomycete *Absidia glauca*: evidence for differences between mating types. *Curr Genet* 19:279–284
- Keeling PJ (2003) Congruent evidence from alpha-tubulin and beta-tubulin gene phylogenies for a zygomycete origin of Microsporidia. *Fungal Genet Biol* 38:298–309
- Keeling PJ, Luker MA, Palmer JD (2000) Evidence from beta-tubulin phylogeny that Microsporidia evolved from within the fungi. *Mol Biol Evol* 17:23–31
- Kenrick P, Crane PR (1997) The origin and early evolution of plants on land. *Nature* 389:33–39
- Kirk PM, Cannon PF, David JC, Stalpers JA (2001) *Ainsworth & Bisby's dictionary of the fungi*, 9th edn. CABI Publishing, Wallingford
- Kobayashi M, Togitani K, Machida H, Uemura Y, Ohtsuki Y, Taguchi H (2004) Molecular polymerase chain reaction diagnosis of pulmonary mucormycosis caused by *Cunninghamella bertholletiae*. *Respirology* 9:397–401
- Kock JLF, Botha A (1998) Fatty acids in fungal taxonomy. In: Frisvad JC, Bridge PD, Arora DK (eds) *Chemical fungal taxonomy*. Marcel Dekker, New York, USA, pp 219–246
- Kontoyiannis DP, Lionakis MS, Lewis RE, Chamilos G, Healy M, Perego C, Safdar A, Kantarjian H, Champlin R, Walsh TJ, Raad II (2005) Zygomycosis in a tertiary-care cancer center in the era of *Aspergillus*-active antifungal therapy: a case-control observational study of 27 recent cases. *J Infect Dis* 191:1350–1360
- Kwasna H, Ward E, Bateman GL (2006) Phylogenetic relationships among Zygomycetes from soil based on ITS1/2 rDNA sequences. *Mycol Res* 110:501–510
- Lemmer K, Losert H, Rickerts V, Just-Nübling SA, Kehrman M, Tintelnot K (2002) Identification of *Cunninghamella* species by molecular methods. *Mycoses* 45:31–36
- Li WH, Graur D (1999) *Fundamentals of molecular evolution*. Sinauer, Sunderland, MA
- Lichtwardt RW (1986) *The Trichomycetes. Fungal associates of Arthropods*. Springer, New York, USA, p 343
- Liou GF, Chen SR, Wei YH, Lee FI, Fu HM, Yuan GF, Stalpers JA (2007) Polyphasic approach to the taxonomy of the *Rhizopus stolonifer* group. *Mycol Res* 111:196–203

- Liu XY, Huang H, Zheng RY (2001) Relationships within *Cunninghamella* based on sequence analysis of ITS rDNA. *Mycotaxon* 80:77–95
- Liu XY, Huang H, Zheng RY (2007) Molecular phylogenetic relationships within *Rhizopus* based on combined analyses of ITS rDNA and *pyrG* gene sequences. *Sydowia* 59:235–253
- Liu XY, Huang H, Zheng RY (2008) Delimitation of *Rhizopus* varieties based on IGS rDNA sequences. *Sydowia* 60:93–112
- Liu XY, Zheng RY (2008) Multiple loci resolving species of *Rhizomucor* and drawing attention to related *Mucor* 2008 International Symposium on Fungal Diversity. Hangzhou, China, Oct. 16–19, 2008. p 22
- Liu YJ, Hodson MC, Hall BD (2006) Loss of the flagellum happened only once in the fungal lineage: phylogenetic structure of kingdom Fungi inferred from RNA polymerase II subunit genes. *BMC Evol Biol* 6:74. doi:10.1186/1471-2148-6-74
- Lukács B, Papp T, Nyilasi I, Nagy E, Vágvölgyi C (2004) Differentiation of *Rhizomucor* species on the basis of their different sensitivities to lovastatin. *J Clin Microbiol* 42:5400–5402
- Luo G, Mitchell TG (2002) Rapid identification of pathogenic fungi directly from cultures by using multiplex PCR. *J Clin Microbiol* 40:2860–2865
- Lutzoni F, Kauff F, Cox CJ, McLaughlin D, Celio G, Dentinger B, Padamsee M, Hibbett D, James TY, Baloch E, Grube M, Reeb V, Hofstetter V, Schoch C, Arnold AE, Miadlikowska J, Spatafora J, Johnson D, Hambleton S, Crockett M, Shoemaker R, Sung GH, Lucking R, Lumbsch T, O'Donnell K, Binder M, Diederich P, Ertz D, Gueidan C, Hansen K, Harris RC, Hosaka K, Lim YW, Matheny B, Nishida H, Pfister D, Rogers J, Rossman A, Schmitt I, Sipman H, Stone J, Sugiyama J, Yahr R, Vilgalys R (2004) Assembling the fungal tree of life: progress, classification, and evolution of subcellular traits. *Am J Bot* 91:1446–1480
- Machouart M, Larché J, Burton K, Collomb J, Maurer P, Cintrat A, Biava MF, Greciano S, Kuijpers AF, Contet-Audonneau N, de Hoog GS, Gérard A, Fortier B (2006) Genetic identification of the main opportunistic Mucorales by PCR-restriction fragment length polymorphism. *J Clin Microbiol* 44:805–810
- Makoto KO (2004) Molecular polymerase chain reaction diagnosis of pulmonary mucormycosis caused by *Cunninghamella bertholletiae*. *Respirology* 9:397–401
- Margulis L (1981) Symbiosis in cell evolution – Life and its environment on the early earth. W.H. Freeman and Company, San Francisco
- McKerracher LJ, Heath IB (1985) The structure and cycle of the nucleus-associated organelle in two species of *Basidiobolus*. *Mycologia* 77:412–417
- McNeill J, Barrie FR, Burdet HM, Demoulin V, Hawksworth DJ, Marhold K, Nicolson DH, Prado J, Silva PC, Skog JE, Wiersema JH, Turland NJ (2006) International code of botanical nomenclature (Vienna code) adopted by the seventh international botanical congress Vienna, Austria, July 2005. A. R. G, Gantner Verlag, Ruggell, Liechtenstein, p 568
- Mendoza L, Taylor JW, Ajello L (2002) The class Mesomycetozoa: a heterogeneous group of microorganisms at the animal-fungal boundary. *Annu Rev Microbiol* 56:315–344
- Mertens JA, Skory CD (2007a) Isolation and characterization of a second glucoamylase gene without a starch binding domain from *Rhizopus oryzae*. *Enzyme Microb Tech* 40:874–880
- Mertens JA, Skory CD (2007b) Isolation and characterization of two genes that encode active glucoamylase without a starch binding domain from *Rhizopus oryzae*. *Curr Microbiol* 54:462–466
- Moreau F (1954) Les Champignons Physiologie, morphologie, développement et systématique. Lechevalier, Paris
- Moss ST (1999) *Astreptonema gammari*: an eccrinid with appendaged spores. *Kew Bull* 54:637–650
- Nagahama T, Sato H, Shimazu M, Sugiyama J (1995) Phylogenetic divergence of the entomophthoralean fungi: evidence from nuclear 18S ribosomal RNA gene sequences. *Mycologia* 87:203–209
- Nagao K, Ota T, Tanikawa A, Takae Y, Mori T, Udagawa S, Nishikawa T (2005) Genetic identification and detection of human pathogenic *Rhizopus* species, a major mucormycosis

- agent, by multiplex PCR based on internal transcribed spacer region of rRNA gene. *J Dermatol Sci* 39:23–31
- Nyilasi I, Ács K, Papp T, Nagy E, Vágvölgyi C (2005) *Agrobacterium tumefaciens*-mediated transformation of *Mucor circinelloides*. *Folia Microbiol* 50:415–420
- O'Donnell K (1979) Zygomycetes in culture. *Palfrey Contributions in Botany*. No 2. Department of Botany, University of Georgia, Athens, Georgia, USA, p 257
- O'Donnell K, Lutzoni F, Ward TJ, Benny GL (2001) Evolutionary relationships among mucoralean fungi (Zygomycota): evidence for family polyphyly on a large scale. *Mycologia* 93:286–296
- Redecker D, Kodner R, Graham LE (2000) Glomalean fungi from the Ordovician. *Science* 289:1920–1921
- Redecker D, Raab P (2006) Phylogeny of the Glomeromycota (arbuscular mycorrhizal fungi): recent developments and new gene markers. *Mycologia* 98:885–895
- Ribes JA, Vanover-Sams CL, Baker DJ (2000) Zygomycetes in human disease. *Clin Microbiol Rev* 13:236–301
- Rickerts V, Loeffler J, Böhme A, Einsele H, Just-Nübling G (2001) Diagnosis of disseminated zygomycosis using a polymerase chain reaction assay. *Eur J Clin Microbiol Infect Dis* 20:744–745
- Roa Engel CA, Straathof AJ, Zijlmans TW, van Gulik WM, van der Wielen LA (2008) Fumaric acid production by fermentation. *Appl Microbiol Biotechnol* 78:379–389
- Sakuradani E, Abe T, Iguchi K, Shimizu S (2005) A novel fungal 3-desaturase with wide substrate specificity from arachidonic acid-producing *Mortierella alpina* 1 S–4. *Appl Microbiol Biotechnol* 66:648–654
- Sakuradani E, Kobayashi M, Shimizu S (1999a) Delta 6-fatty acid desaturase from an arachidonic acid-producing *Mortierella* fungus: gene cloning and its heterologous expression in a fungus, *Aspergillus*. *Gene* 238:445–453
- Sakuradani E, Kobayashi M, Shimizu S (1999b) Delta 9-fatty acid desaturase from arachidonic acid-producing fungus. Unique gene sequence and its heterologous expression in a fungus, *Aspergillus*. *Eur J Biochem* 260:208–216
- Sakuradani E, Kobayashi M, Ashikari T, Shimizu S (1999c) Identification of Delta 12-fatty acid desaturase from arachidonic acid-producing *Mortierella* fungus by heterologous expression in the yeast *Saccharomyces cerevisiae* and the fungus *Aspergillus oryzae*. *Eur J Biochem* 261:812–820
- Sakuradani E, Shimizu S (2003) Gene cloning and functional analysis of a second delta 6-fatty acid desaturase from an arachidonic acid-producing *Mortierella* fungus. *Biosci Biotechnol Biochem* 4:704–711
- Schipper MAA (1973) A study on variability in *Mucor hiemalis* and related species. *Stud Mycol* 4:1–40
- Schipper MAA (1975) *Mucor mucedo*, *Mucor flavus* and related species. *Stud Mycol* 10:1–33
- Schipper MAA (1976) On *Mucor circinelloides*, *Mucor racemosus* and related species. *Stud Mycol* 12:1–40
- Schipper MAA (1978) On certain species of *Mucor* with a key to all accepted species. *Stud Mycol* 17:1–52
- Schipper MAA (1984) A revision of the genus *Rhizopus* I: the *Rhizopus stolonifer*-group and *Rhizopus oryzae*. *Stud Mycol* 25:1–19
- Schipper MAA, Stalpers JA (1984) A revision of the genus *Rhizopus* II: the *Rhizopus microsporus*-group. *Stud Mycol* 25:20–34
- Schmitt I, Crespo A, Divakar PK, Fankhauser JD, Herman-Sackett E, Kalb K, Nelsen MP, Nelson NA, Rivas-Plata E, Shimp AD, Widhelm T, Lumbsch HT (2009) New primers for promising single copy genes in fungal phylogenetics and systematics. *Persoonia* 23:35–40
- Schüßler A (2002) Molecular phylogeny, taxonomy, and evolution of *Geosiphon pyriformis* and arbuscular mycorrhizal fungi. *Plant Soil* 244:75–83
- Schüßler A, Schwarzott D, Walker C (2001) A new fungal phylum, the Glomeromycota: phylogeny and evolution. *Mycol Res* 105:1413–1421

- Schwarz P, Bretagne S, Gantier JC, Garcia-Hermoso D, Lortholary O, Dromer F, Dannaoui E (2006) Molecular identification of zygomycetes from culture and experimentally infected tissues. *J Clin Microbiol* 44:340–349
- Schwarz P, Lortholary O, Dromer F, Dannaoui E (2007) Carbon assimilation profiles as a tool for identification of zygomycetes. *J Clin Microbiol* 45:1433–1439
- Seif E, Leigh J, Liu Y, Roewer I, Forget L, Lang BF (2005) Comparative mitochondrial genomics in zygomycetes: bacteria-like RNase P RNAs, mobile elements and a close source of the group I intron invasion in angiosperms. *Nucleic Acids Res* 33:734–744
- Simon L, Bousquet J, L  vesque RC, Lalonde M (1993) Origin and diversification of endomycorrhizal fungi and coincidence with vascular land plants. *Nature* 363:67–69
- Swofford DL (1998) PAUP\*: phylogenetic analysis using Parsimony (\*and Other Methods) Version 4. Sinauer Associates, Sunderland, MA
- Tanabe Y, Saikawa M, Watanabe MM, Sugiyama J (2004) Molecular phylogeny of Zygomycota based on EF-1alpha and RPB1 sequences: limitations and utility of alternative markers to rDNA. *Mol Phylogenet Evol* 30:438–449
- Tanabe Y, Watanabe MM, Sugiyama J (2005) Evolutionary relationships among basal fungi (Chytridiomycota and Zygomycota): insights from molecular phylogenetics. *J Gen Appl Microbiol* 51:267–276
- Taylor JW, Berbee ML (2006) Dating divergences in the fungal tree of life: review and new analyses. *Mycologia* 98:838–849
- Thompson JD, Gibson TJ, Plewniak F, Jeanmougin F, Higgins DG (1997) The Clustal X windows interface: flexible strategies for multiple sequence alignment aided by quality analysis tools. *Nucleic Acids Res* 25:4876–4882
- Trotter MJ, Whisler HC (1965) Chemical composition of the cell wall of *Amoebidium parasiticum*. *Can J Bot* 43:869–876
- Turenne CY, Sanche SE, Hoban DJ, Karlowsky JA, Kabani AM (1999) Rapid identification of Fungi by using the ITS2 genetic region and an automated fluorescent capillary electrophoresis system. *J Clin Microbiol* 37:1846–1851
- Ustinova I, Krienitz L, Huss VAR (2000) *Hyaloraphidium curvatum* is not a green alga, but a lower fungus; *Amoebidium parasiticum* is not a fungus, but a member of the DRIPS. *Protist* 151:253–262
- Valle LG, Cafaro MJ (2008) First report of zygospores in *Asellariales* and new species from the Caribbean. *Mycologia* 100:122–131
- van den Ent F, Amos LA, L  we J (2001) Prokaryotic origin of the actin cytoskeleton. *Nature* 413:39–44
- Vastag M, Papp T, Kasza Z, V  gv  lgyi C (2000) Intraspecific variation in two species of *Rhizomucor* assessed by random amplified polymorphic DNA analysis. *J Basic Microbiol* 40:269–277
- V  gv  lgyi C, Heinrich H,   cs K, Papp T (2004) Genetic variability in the species *Rhizopus stolonifer*, assessed by random amplified polymorphic DNA analysis. *Antonie Leeuwenhoek* 86:181–188
- V  gv  lgyi C, Vastag M,   cs K, Papp T (1999) *Rhizomucor tauricus*: a questionable species of the genus. *Mycol Res* 103:1318–1322
- Voigt K, Cigelnik E, O'Donnell K (1999) Phylogeny and PCR identification of clinically important Zygomycetes based on nuclear ribosomal-DNA sequence data. *J Clin Microbiol* 37:3957–3964
- Voigt K, Hoffmann K, Einax E, Eckart M, Papp T, V  gv  lgyi L, Olsson L (2009) Revision of the family structure of the Mucorales (Mucoromycotina, Zygomycetes) based on multigene-genealogies: phylogenetic analyses suggest a bigeneric Phycomycetaceae with *Spinellus* as sister group to *Phycomyces*. In: Gherbawy Y, Mach RL, Rai M (eds) *Current advances in molecular mycology*. Nova Science Publishers, Inc, New York, pp 263–312
- Voigt K, W  stemeyer J (2001) Phylogeny and origin of 82 zygomycetes from all 54 genera of the Mucorales and Mortierellales based on combined analysis of actin and translation elongation factor EF-1alpha genes. *Gene* 270:113–120

- Walker C, Vestberg M, Demircik F, Stockinger H, Saito M, Sawaki H, Nishimura I, Schüssler A (2007) Molecular phylogeny and new taxa in the Archaeosporales (Glomeromycota): *Ambispora femica* gen. sp. nov., Ambisporaceae fam. nov., and emendation of *Archaeospora* and Archaeosporaceae. *Mycol Res* 111:137–153
- Wang F, Fang Y, Zhang M, Lin A, Zhu T, Gu Q, Zhu W (2008) Six new ergosterols from the marine-derived fungus *Rhizopus* sp. *Steroids* 73:19–26
- Wang DYC, Kumar S, Hedges SB (1999) Divergence time estimates for the early history of animal phyla and the origin of plants, animals and fungi. *Proc Roy Soc Lond B* 266:163–171
- Weete JD, Gandhi S (1997) Sterols of the phylum Zygomycota: phylogenetic implications. *Lipids* 32:1309–1316
- Weete JD, Gandhi SR (1999) Sterols and fatty acids of the Mortierellaceae: taxonomic implications. *Mycologia* 91:642–649
- Weete J, Shewmaker F, Gandhi S (1998)  $\gamma$ -Linolenic acid in zygomycetous fungi: *Syzygites megalocarpus*. *J Am Oil Chem Soc* 75:1367–1372
- White MM, James TY, O'Donnell K, Cafaro MJ, Tanabe Y, Sugiyama J (2006) Phylogeny of the Zygomycota based on nuclear ribosomal sequence data. *Mycologia* 98:872–884
- White TJ, Bruns T, Lee S, Taylor JW (1990) Amplification and direct sequencing of fungal ribosomal RNA genes for phylogenetics. In: Innis MA, Gelfand DH, Sninsky JJ, White TJ (eds) PCR protocols: a guide to methods and applications. Academic Press, New York, USA, pp 315–322
- Wu Z, Tsumura Y, Blomquist G, Wang XR (2003) 18S rRNA gene variation among common airborne fungi, and development of specific oligonucleotide probes for the detection of fungal isolates. *Appl Environ Microbiol* 69:5389–5397
- Zhang J, Henriksson H, Szabo IJ, Henriksson G, Johansson G (2005) The active component in the flax-retting system of the zygomycete *Rhizopus oryzae* sb is a family 28 polygalacturonase. *J Ind Microbiol Biotechnol* 32:431–438
- Zheng RY, Chen GQ (2001) A monograph of *Cunninghamella*. *Mycotaxon* 80:1–75
- Zheng RY, Chen GQ, Huang H, Liu XY (2007) A monograph of *Rhizopus*. *Sydowia* 59:273–372
- Zheng RY, Jiang H (1995) *Rhizomucor endophyticus* sp. nov., an endophytic zygomycetes from higher plants. *Mycotaxon* 56:455–466
- Zheng RY, Liu XY (2005) *Actinomucor elegans* var. *meitauzae*, the correct name for *A. taiwanensis* and *Mucor meitauzae* (Mucorales, Zygomycota). *Nova Hedwigia* 80:419–431
- Zheng RY, Liu XY (2009) Taxa of *Pilaira* (Mucorales, Zygomycota) from China. *Nova Hedwigia* 88:255–267

# Index

## A

- Absidia*, 464, 470–474, 478, 479  
*A. aegyptiacum*, 452  
*A. anomala*, 444, 451, 457  
*A. caerulea*, 444, 451, 452, 457  
*A. californica*, 444, 451, 457  
*A. capillata*, 452  
*A. clavata*, 452  
*A. corymbifera*, 445  
*A. cuneospora*, 444, 451, 457  
*A. cylindrospora*, 444, 451, 452, 457  
*A. cylindrospora* var. *cylindrospora*, 441, 451  
*A. cylindrospora* var. *nigra*, 441, 451  
*A. cylindrospora* var. *rhizomorpha*, 441, 451  
*A. dubia*, 446  
*A. fassatia*, 452  
*A. fusca*, 444, 451  
*A. glauca*, 444, 451, 457  
*A. griseola*, 452  
*A. heterospora*, 451  
*A. idahoensis* var. *thermophila*, 440  
*A. inflata*, 452  
*A. macrospora*, 444, 451, 457  
*A. narayanai*, 452  
*A. pseudocylindrospora*, 444, 451, 452  
*A. psychrophilia*, 444, 452, 457  
*A. reflexa*, 451, 452  
*A. repens*, 444, 451, 454, 455, 457  
*A. robusta*, 452  
*A. scabra*, 451, 452  
*A. septata*, 451, 452  
*A. spinosa*, 444, 457  
*A. spinosa* var. *azygospora*, 441, 451  
*A. spinosa* var. *biappendiculata*, 441, 451  
*A. spinosa* var. *spinosa*, 441, 451  
*A. tuneta*, 452  
*A. ushtrina*, 452  
description, 440  
distinction, 444, 445  
mesophilic species, 440, 444  
molecular aspects, 440  
molecular key, 452–454  
morphological aspects, 440–442  
phylogenetic analyses, 442, 444, 453  
phylogeny, 442  
physiological aspects, 440, 442, 445  
polyphyly, 442  
sensu lato, 440–442  
sensu stricto, 440–442, 444–445, 453, 457  
synoptic key, 450–452  
thermotolerant species, 440, 445, 449  
Absidiaceae, 444–445, 450–452  
Abundance, underestimated, 71  
Acid  
  arachidonic acid, 475  
  eicosapentaenoic acid (EPA), 476  
  fatty acids, 464, 466, 474–476  
  fumaric acids, 475  
  organic acid, 475  
Actin, MreB, 463  
*Actinomucor*, 471

- Albuginales, 39  
 Albuginomycetidae, 37  
*Albugo candida*, 37, 41  
 All Fungi Barcoding, 146  
 Alternative host plants, 73  
 Amplified fragment length polymorphism (AFLP), 40, 113, 134, 137, 198–200, 202, 204, 279–281  
 Anamorphs, 287  
 Ancient DNA, 35  
*Anisogramma anomala*, 16  
 Antimycotics  
   amphotericin B, 476  
   nephrotoxic side effects, 476  
*Antrodia* spp., 253  
   *Antrodia vaillantii*, 262  
*Arabidopsis thaliana*, 70  
 Archaeophytes, 5  
*Armillaria* spp., 254, 255, 257, 258, 260, 262, 263, 265  
   *A. borealis*, 254  
   *A. cepistipes*, 254  
   *A. gallica*, 254  
   *A. mellea*, 25, 254, 255, 258, 263  
   *A. ostoyae*, 254, 258, 263  
   *A. tabescens*, 254, 263  
 Ascomycota, 215, 228  
*Aspergillus*, 198, 199, 201, 207, 319, 320, 323, 324  
   *A. alliaceus*, 197  
   *A. carbonarius*, 197, 200–207  
   *A. fumigatus*, 326  
   *A. niger*, 197, 200–204  
   *A. ochraceus*, 197–201, 203, 205, 207  
   *A.* section *Circumdati*, 198–199  
   *A. westerdijkiae*, 197, 199–201, 203–206  
     laboratory diagnosis, 367–368  
     molecular detection, 368–373  
 Atopic dermatitis, 338, 339
- B**  
 Bait tests, 60  
 Barcoding, 42, 72, 481  
 Basal fungal lineages, 215  
*Basidiobolus*, Basidiobolaceae, 467, 468  
 Basidiomycota, 215, 217, 228  
*Batrachochytrium dendrobatidis*, 13  
 Bayesian inference, 442, 456  
 Biosynthetic pathway  
   20-carbon PUFA biosynthesis, 476  
   n-3 PUFA biosynthetic pathway, 476  
   n-6 PUFA biosynthetic pathway, 475, 476  
 Blastocladiomycota, 215  
*Blastomyces dermatitidis*  
   laboratory diagnosis, 373–374  
   molecular detection, 374  
 Blood  
   culture, 322, 323, 326, 327  
   whole, 317–328  
 Blood stream infection (BSI), 322, 327  
   therapy, 322  
*Blumeria graminis*, 11  
 Botryosphaeria, 25  
 Buffon's law, 7
- C**  
*Calmodulin* gene, 140  
 Cambrian, 467  
*Candida*, 318–324  
   *C. albicans*, 318, 319, 323, 324, 326, 327  
   *C. glabrata*, 319, 321, 323, 326  
   *C. krusei*, 319, 321, 323, 326  
   *C. parapsilosis*, 319, 326  
   *C. tropicalis*, 319, 324, 326  
     laboratory diagnosis, 377–378  
     molecular detection, 378–382  
 Candidaemia, 318–319, 321  
 Carbon assimilation profiles, 479–480  
*Ceratocystis fagacearum*, 13, 16  
*Cerotelium*, 9  
 Characteristics  
   barcode, 481  
   biochemical, 213  
   chemotaxonomical, 241  
   diagnostic importance, 230  
   ecological, 214  
   growth temperature, 471–473  
   isoenzyme patterns, 473  
   mating compatibility, 471, 473  
   mesophilic, 470, 472, 473  
   metabolic, 214  
   molecular, 214, 227, 461–481  
   morphological, 213, 215, 227, 230, 464, 467, 470–473, 477, 481



- phylogenetic relevance, 221, 223, 237
  - physiological, 213, 241
  - synapomorphic, 471
  - thermophilic, 464, 472, 473
  - thermotolerant, 470, 471
  - zygospore, 468, 470, 471
  - Charcoal rot, 108, 181
  - Chasmothecial appendage, 85, 86, 88, 89
  - Chemotype
    - 3ADON chemotype, 161–167, 169–174
    - 15ADON chemotype, 161–167, 169–174
    - molecular chemotype, 164, 169, 170, 173
    - NIV chemotype, 160–162, 165–167, 170–172, 174
  - Chickpea, 80–83
  - China, 161, 163, 165, 166, 169, 171, 173
  - Chlamydoabsidia*, 441, 442, 444, 445, 450
  - Chromatography, affinity, 323, 326–328
  - Chytridiomycota, 215
  - Chytrids, 468
  - Ciborinia camelliae*, 11
  - Cicer arietinum*, 80
  - Circinella*, 447
  - Cladosporium*, 7
    - C. subtilissimum*, 8
  - Classification
    - DNA-based, 467, 472, 480
    - morphology-based, 467, 472
    - traditional, 467
  - Cleaved amplified polymorphic sequence (CAPS), 147
  - Clinical specimens
    - BAL, 371, 372, 378, 390
    - blood, 363, 368, 371, 372, 375, 377, 378, 381, 382, 386, 390, 391, 393, 394
    - CSF, 363, 385, 386
    - serum, 371, 372, 378, 382, 386, 391
    - serum, plasma, 363, 371
    - skin, 360, 373, 388, 391, 394, 395
    - tissue, 361, 367, 368, 371, 373, 378, 383, 384, 388, 390–392, 394
    - urine, 372, 386
  - Coccidioides* spp.
    - laboratory diagnosis, 383
    - molecular detection, 384
  - Cochliobolus carbonum*, 9
  - Coleosporium helianthi*, 10
  - Compatibility
    - mating, 471
    - tests, 257
  - Confluent and reticulate papillomatosis, 338, 339
  - Coniophora puteana*, 253, 261
  - cox2, 37, 38, 41
  - C-reactive protein (CRP), 321
  - Cronartium*
    - C. occidentale*, 20
    - C. quercuum* f.sp. *fusiforme*, 16
    - C. ribicola*, 18, 19
  - Cryphonectria parasitica*, 24
  - Cryptococcus neoformans*
    - laboratory diagnosis, 385–386
    - molecular detection, 386–387
  - Cultivation-dependent method, 278, 287
  - Culture collections, 214
  - Cunninghamella*, 444, 445, 464, 471, 475–478
  - Cutinase* gene, 141
  - Cytochrome c oxidase subunit I (COI), 146
- D**
- D-arabinitol, 321
  - D1/D2 domain, phylogenetic trees, 345, 348, 351
  - D-dimer, 321, 322
  - Dematiaceous
    - laboratory diagnosis, 388
    - molecular detection, 388–389
  - Denaturing gradient gel electrophoresis (DGGE), 279, 281–282, 287
  - Deoxynivalenol (DON), 160
  - Derived cleaved amplified polymorphic sequence (dCAPS), 147, 148
  - Dermatophytes
    - laboratory diagnosis, 396
    - molecular detection, 396–397
  - Devonian, 469
  - $\beta$ -D-glucan, 320
  - Diagnostic tools, 184–187
  - Dictyosome, 467
  - Dikarya, 215
  - Dikaryomycota*
    - Ascomycota, 468, 480
    - Basidiomycota, 464, 469, 470, 480

- Dimorphic, 360, 373, 382, 384, 390  
 Dimorphic ascospores, 83  
*Discula destructiva*, 15  
 Divergence  
   of Asco- and Basidiomycota, 469  
   of Metazoa and fungi, 469  
 Diversity  
   ecological, 462, 464, 467  
   global biodiversity information faculty, 481  
 DNA, 303, 307–310, 317–328  
   array, 100, 137, 144  
   background, 326  
   extraction, 68, 165  
   fingerprinting, 279–282, 287, 289  
   human background, 326  
   hybridization, 307  
   manipulations, 362–364  
   methylation, 326  
   microarray, 324, 328  
   nuclear ribosomal, 303  
   polymorphism, 307  
   rDNA, 467–475, 477–478  
   ribosomal, 468, 473, 474, 477, 478, 481  
 DNA barcodes, 80, 89, 145–147, 149, 214, 215, 240, 242  
   alternative barcode markers, 215  
   barcode markers in combination, 234  
   beta-tubulin, 234  
   calmodulin, 234  
   Consortium for the Barcode of Life (CBOL), 214  
   *cox1*, 214–215  
   cytochrome b (*cob*), 215  
   IGS, 240  
   internal transcribed spacer (ITS), 215, 217–222, 224–228, 239–240  
   16S rDNA, 215  
   28S rDNA, 221, 235, 240  
   translation elongation factor 1 alpha, 221, 227, 234  
   universal barcode marker, 214  
*Donkioporia expansa*, 253
- E**  
 Ecological importance, 72  
 Electrophoresis  
   fluorescent capillary, 477, 478  
   pulsed field gel electrophoresis (PFGE), 462, 477, 479  
 Endocommensal, 464  
*Endocronartium harknessii*, 21  
 Endomycorrhiza, arbuscular, 468, 469  
 Endophyte, 277, 278, 280–282, 285, 288, 289  
 Endophytic fungi, 277–289  
*Endo-polygalacturonase* gene (*pgI*), 140  
*Entoleuca mammata*, 13  
*Entomophthoromycotina*  
   arbuscular endomycorrhiza, 468, 469  
   Entomophthorales, 464, 467, 468, 476, 484  
 Enzyme-linked immunosorbent assay (ELISA), 62, 168, 258  
 Erysiphales, 84  
*Erysiphe*  
   *E. pisi*, 85, 86  
   *E. trifolii*, 81, 85–89  
 Evolution  
   actin, 462–464, 469, 471, 474, 475  
   EF-1 alpha, 469, 471, 473  
   linear, 469  
   tubulin, 462–464, 468  
 Exaptation, 14
- F**  
 Fahrenheit's rule, 11  
 Fatty acids  
   n-3 PUFA, 476  
   n-6 PUFA, 475, 476  
   polyunsaturated, 474–476  
   PUFA, 474–476  
*Fennellomyces linderi*, 447, 448, 457  
 Filamentous fungi, 195  
 Fingerprinting  
   amplified fragment length polymorphism (AFLP), 474, 475, 479  
   microsatellite PCR, 477, 479  
   PCR-RFLP, 477–479  
   pulsed field gel electrophoresis (PFGE), 462, 479  
   restriction fragment length polymorphism (RFLP), 477, 479  
   whole-genome, 479  
 Finland, 159–174  
 Forestry, 252

Fruit bodies, 252, 256, 267, 268

Fumonisin

  biosynthesis, 120

  effects, 109

*F. nygamai*, 108, 115

*F. proliferatum*, 108, 111, 114–118

*F. verticillioides*, 108, 111, 114–120

  structure, 108

  toxic action, 108–110

Fungi, Dikaryomycota, 470

*Fusarium* head blight (FHB), 159

*Fusarium oxysporum*

*formae speciales*, 132, 134, 136–145, 147, 150

*Fusarium* spp., 93–102, 185, 319

  biological species concept, 113, 115

*F. asiaticum*, 163, 167, 172

*F. avenaceum*, 161

*F. cerealis*, 159–174

*F. culmorum*, 159–174

*F. graminearum*, 159–174

*F. ussurianum*, 173

  laboratory diagnosis, 389–390

  molecular detection, 390

  morphological species concept, 113–115

  phylogenetic species concept, 113–116, 119

*Fuscoporia torulosa*, 266

**G**

*Ganoderma* spp., 255, 256, 258, 263, 265

Gene, 302, 303, 308

*Ac12RL3* gene, 206, 207

  actin, 462–463, 469, 471, 474, 475

  actin (act), 302, 304, 307

  beta-tubulin (*btub*), 307, 308

  cytochrome, 478–479

$\Delta 5$ -desaturase, 476

$\Delta 9$ -desaturase, 476

$\Delta 12$ -desaturase, 476

  encoding  $\omega 3$ -desaturase, 476

  GenBank, 465, 466, 481

  lactate dehydrogenase B, 475

  orthologous, 303

*otapksPN* gene, 207, 208

  paralogous, 303

*pks* gene, 200, 207–208

  protein coding, 307

  repetitive, 303

  single copy, 303, 307, 481

  translation elongation factor (tef), 303, 307

  translation elongation factor-1alpha, 474, 475

Genome

  analysis, 145

  mitochondrial, 480

*Mucor*, 462, 464, 465, 471, 472, 476, 478–480

*Phycomyces*, 462, 466, 480, 481

*Rhizopus*, 462, 464, 466, 470, 472–476, 478–481

  sequencing, 145–147

Genomes OnLine Database (GOLD), 145

Genomics, 68–71

Genotyping

  microsatellite PCR, 477, 479

  PCR-RFLP, 477–479

  pulsed field gel electrophoresis (PFGE), 462, 477, 479

  randomly amplified polymorphic DNA (RAPD), 462, 473, 477, 479

  restriction fragment length polymorphism (RFLP), 473, 477–479

  whole-genome, 479

Geosiphonales, *Geosiphon*, 468

Germany, 163, 165, 166, 169–171

*Gloeophyllum* spp., 253

*Gloeophyllum sepiarium*, 262

Glomeromycota, 215

*Glomeromycota*, Geosiphonales, 467, 468

Glucoamylase, 474

*Gongronella*, 441, 442, 444, 445

Gougerot and Carteaud syndrome, 338, 340

*gp43*, 422–424, 427–430

Graminicolous downy mildews, 37, 39

Group I introns, 81–84, 89

*Gymnosporangium fuscum*, 23

**H**

*Halteromyces*, 444, 445

Herbarium specimens, 42

*Hesseltinella*, 444

*Heterobasidion annosum sensu lato* (s.l.), 254, 255, 257, 260, 262–264, 267

*H. abietinum*, 255, 262, 264

*H. annosum sensu stricto* (s.s.), 255, 262–264  
*H. parviporum*, 255, 262–264  
 High performance liquid chromatography (HPLC), 136  
*Histoplasma capsulatum*  
   laboratory diagnosis, 391  
   molecular detection, 391–392  
 Holocene, 3, 5  
 Homogocene, 3–27  
*Hyaloperonospora*, 39  
 Hybridization probes, 187, 188  
 Hypertrophies, 53, 60  
*Hypocrea*, 185

## I

Identification, 56, 62  
   of *Aspergillus*, 368–369, 372  
   barcode, 481  
   of *Blastomyces dermatitidis*, 373, 374  
   of *Candida*, 374, 376  
   of chromoblastomyces, 388–389  
   of *Coccidioides*, 383, 384  
   of *Cryptococcus neoformans*, 387  
   of dermatophytes, 396, 397  
   of filamentous fungi, 372  
   of *Fusarium*, 389, 390  
   of *Histoplasma*, 390, 391  
   of molds and yeasts, 359  
   morphological, 464, 472, 473, 477, 481  
   phenotype-based identification, 397  
   physiochemical, 472, 473  
   preliminary identification, 377  
   species identification, 359, 381, 396, 397  
   of *Trichosporon*, 393  
   of yeasts, 359  
   of Zygomycetes, 394  
 Immunological test methods, 62  
 Infection  
   fungal, 471, 476–478, 480  
   invasive fungal infections (IFI), 319–321, 323  
   nosocomial, 319  
   zygomycosis, 472, 476, 478, 480  
*Inonotus* spp., 254, 263, 265  
*I. tomentosus*, 255  
 Intergenic spacer (IGS), 138–139

Internal transcribed spacer (ITS), 41–44, 80–83, 85–89, 138–139  
 Inter-simple sequence repeat (ISSR), 137, 279–281  
 Intraspecific phylogeny, 58  
 Invasive/disseminated fungal infections (IFI)  
   angioinvasive moulds, 389  
   angioinvasive zygomycosis, 393  
   cryptococcosis, 385  
   diagnosis of IFI, 361–362  
   diagnosis of invasive aspergillosis, 368, 371  
   invasive aspergillosis, 367, 389  
   invasive candidiasis, 375  
   invasive candidosis, 382  
   invasive fusariosis, 389  
   invasive mold infection, 372, 389  
   invasive pulmonary aspergillosis, 362, 371  
   invasive trichosporonosis, 392  
   limited invasive disease, 367  
   progressive invasive disease, 367  
   risk factors for invasive aspergillosis, 367  
 Isozyme, 134, 136  
   analysis, 39, 257, 307  
 iSSR, 41  
 ITS regions, phylogenetic trees, 345, 348, 351

## K

*Kickxellomycotina*  
   Harpellales, 464, 467, 468  
   Kickxellales, 464, 467, 468  
*Kretzschmaria deusta*, 254  
*Kuehneola*, 9

## L

*Laetiporus sulphureus*, 254  
 Large-subunit, D2, 477  
*Lens culinaris*, 80  
*Lentamyces*  
   *L. parricida*, 446–449, 452, 457  
   *L. zychae*, 446–449, 452, 457  
   morphological aspects, 447, 448  
   mycoparasitism, 447  
   physiological aspects, 447

- RFLP, in silico, 448  
 sucker-like substrate mycelium, 447
- Lentil, 80, 81, 84–89
- Lichtheimia*  
 discrimination from *Absidia*, 453  
*L. corymbifera*, 445, 446, 450  
*L. hyalospora*, 446, 450  
*L. ornata*, 446, 450  
*L. ramosa*, 446, 450, 454, 457  
*L. sphaerocystis*, 446, 450  
 morphological aspects, 445  
 physiological aspects, 445
- Lichtheimiaceae, 440, 445–446, 450
- Lichtheimiaceae, *Lichtheimia*, 471
- Life cycle, 51–73
- Ligniera*, 71
- Loop-mediated isothermal amplification (LAMP) methods, 417–435
- LOOXSTER<sup>®</sup>, 327
- Lophodermium pinastri*, 22
- LSU, large-subunit, 477
- Lysis  
 mechanical, 325, 326  
 pathogen cells, 325
- M**
- Macrophomina phaseolina*  
 biochemical and serological characterization, 182  
 classification and nomenclature, 180–181  
 identification and characterization, 181  
 morphological and cultural characteristics, 181
- Maize, mycotoxins, 108, 111
- Malassezia* spp  
 identification, 337, 338, 340, 341, 344, 345  
*M. caprae*, 343  
*M. dermatis*, 341–343, 348  
*M. equi*, 343  
*M. equina*, 343  
*M. furfur*, 338, 340–342, 345, 348  
*M. globosa*, 338, 339, 341–343, 345, 348  
*M. japonica*, 342, 343, 348  
*M. nana*, 342, 343  
 molecular techniques, 338, 343  
*M. pachydermatis*, 340–343, 345, 348, 351  
*M. restricta*, 339, 341, 342, 345, 348  
*M. sloffiae*, 345  
*M. sympodialis*, 338, 341–343, 348, 351  
*M. yamatoensis*, 342, 343, 348  
 phenotypical and physiological features, 341  
 rDNA genes, 344
- Melampsora*  
*M. hypericorum*, 9, 10  
*M. larici-populina*, 21  
*M. medusae*, 20, 21  
*M. occidentalis*, 20
- Melampsora x columbiana*, 21
- Meruliporia incrassata*, 253
- Mesomycetozoa*, Eccrinales, 464
- Metagenomics, 148, 149
- Metazoa, 469
- Microarrays, 70, 142, 144–145, 147–150, 268, 269, 461
- Microcyclus ulei*, 26
- Minimum ages, 469, 470
- Molecular  
 actin, 462–464, 469, 474, 475  
 chemotype, 164, 169, 170, 173  
 clocks, 469  
 data available, 71  
 detection, 131–150  
 lactate dehydrogenase B, 474, 475  
 tools, restriction fragment length polymorphism, 183–184  
 translation elongation factor-1alpha, 462–464, 474, 475
- Molecular assays, amplicon size, PCR and sequencing  
 fluorescence-based PCR, 395  
 FRET probes, 395  
 in-house and commercial PCR, 372  
 LAMP, 380  
 multiplex PCR, 372, 373, 387, 390, 394  
 nested PCR, 374, 378, 384, 386, 387, 393  
 panfungal PCR, 367, 368  
 PCR and cryptococcosi, 386  
 PCR direct on BAL, 371  
 PCR ELISA, 368, 371  
 PCR-RFLP, 387, 396, 397  
 PCR serotyping, 387  
 PCR vs. blood cultures, 382  
 qPCR, 371, 395

- quantitative real time, 371, 393  
 real time, 371–373, 384, 393, 395  
 rep-PCR, 360, 372, 374, 381, 384, 392  
 seminested PCR, 391, 394
- Molecular basis of plasmodiophorid infection**, 69
- Monitoring**, 60
- Monophyletic**, 39  
 origin, 132
- Morphological characters**, 36
- Morphology**  
 subsporangial swelling, 471  
 trophocyst, 471
- Morphotypes**, 280, 284–286, 288
- Mortierellomycotina**  
 Endogonales, 469  
 Mortierellales, 469
- Mucor**, 213–243  
*M. circinelloides*, 216, 221, 222, 224, 226, 229–231, 233, 236, 238–240, 447, 448, 457  
*M. circinelloides f. circinelloides*, 222, 227, 233, 238, 239  
*M. circinelloides f. griseo-cyanus*, 221, 233, 234, 238–240  
*M. circinelloides f. janssenii*, 236  
*M. circinelloides f. lusitanicus*, 227, 228, 233, 236, 238, 239  
*M. corymbifer*, 445  
*M. mucedo*, 226, 236  
*M. racemosus*, 221, 226, 236  
 polyphyletic, 235–237
- Mucorales**  
*Absidia*, 470–472, 476, 478  
*Actinomucor*, 471  
*Cunninghamella*, 471, 476, 478  
 facultative parasites, 439, 447, 452  
 Lichtheimiaceae, 471  
*Mucor*, 471, 472, 476, 478  
 mycoparasitic species, 440, 446  
 opportunistic pathogens, 439  
*Pilaira*, 471–472  
 Pilobolaceae, 471  
*Rhizomucor*, 472–473, 476, 478  
*Rhizopus*, 470, 472–474, 476, 478  
 saprobes, 439  
 Umbelopsidaceae, 469
- Mucormycoses**, 216, 235, 236, 240, 439, 445
- Mucoromycotina**  
 Mucorales, 469, 476
- Multilocus genotyping (MLGT)**, 161, 163, 167–168, 170, 172
- Multiplex PCR**, 141
- Multiplex polymerase chain reaction (m-PCR)**, 203–204
- Mycocladales**, 446  
 Mycocladiaceae, 470  
 Mycocladus, 470–471
- Mycocladius verticillatus*, 446
- Mycorrhiza**  
 ectomycorrhiza, 464  
 endomycorrhiza, 469
- Mycosphaerella*  
*M. fijiensis*, 4  
*M. musicola*, 4  
*M. populicola*, 22
- Mycotoxins**, 195–198, 207–208
- N**
- Necrosis**, 169, 171
- Neocallimastigomycota**, 215
- Neolithic**, 3, 5, 6, 17
- Neophytes**, 5
- Next-generation sequencing**, 147
- Nivalenol (NIV)**, 160
- NIV chemotype**, 160–162, 165–167, 170–172, 174
- Non-sporulating endophytic fungi**, 284–285, 289
- Nucleic acid amplification technique (NAT)**, 323–328
- Nucleic-acid-based detection methods**, 63–68
- O**
- Obligate intracellular parasites**, 52
- Ochratoxigenic fungi**, 195–209
- Ochratoxin A (OTA)**  
 biosynthetic pathway genes, 206–208  
 chemical structure, 196  
 effects, 196–197  
 molecular marker, 197–198  
 PCR detection and quantification, 198–208  
 producer, 197

- regulations, 197
- Ochroconis gallopava*, 417–435
- Oligonucleotide, 303
  - microsatellite, 477
  - universal, 303
- Oligoporus placenta*, 253
- On-site PCR, 68
- Oospore ornamentation, 39
- Ophiostoma*, 16
  - O. novo-ulmi*, 17
  - O. ulmi*, 17
- Opportunistic, 358, 360, 361, 367, 373, 392
- Origin
  - of Mortierellales, 469
  - of Mucorales, 469
- P**
- Paleozoic, 470
- Panfungal assays, 364–367
- Paracoccidioides*
  - P. brasiliensis*, 418, 419, 421–431
  - P. lutzii*, 423, 424
- Paracoccidioidomycosis, 417–435
- Parasites
  - obligate, 464
- Pathogen, 470, 472, 476–479
- Pathogenicity, 132, 136, 149, 150, 163, 168–169, 171–172
- Pathogen release hypothesis, 8–10
- Pathway, biosynthetic pathway, 476
- Patients
  - immunocompromised, 476
  - immunosuppressed, 476
- PCR chemotyping, 165–167
- PCR-fingerprinting techniques
  - ITS, 183, 185–187
  - ITS-RFLP, 186
- Penicillium*, 199, 204
  - P. nordicum*, 200, 204, 207, 208
  - P. verrucosum*, 197, 200, 204, 208
- Perenniporia fraxinea*, 254
- Peridiopsora, 9
- Peronospora*
  - P. farinosa*, 37
  - P. sparsa*, 43
- Phacidium infestans*, 22
- Phagomyxa, 57
- Phagomyxids, 52, 57, 71, 72
- Phakopsora, 9
- Phakopsora*
  - P. meibomiaae*, 9
  - P. pachyrhizi*, 9
- Phellinus* spp., 254, 255, 263, 265
  - P. noxius*, 263
  - P. sulphurascens*, 261
  - P. weirii*, 255
- Phenotypic characters, 39
- Phlebia* spp., 255, 263
- Phylogenetic analysis, parsimony analysis, 87
- Phylogenetic marker
  - actin (*act*), 442–444, 456
  - ribosomal DNA, 442, 444, 448, 449, 453–456
  - translation elongation factor 1 alpha (*tef*), 442–444, 456
- Phylogenetics, 462, 465–466, 469, 472, 481
  - coherence, 470
  - molecular, 462, 470, 481
  - multigene, 471
- Phylogeny
  - actin, 462–464
  - DNA-based, 466–468, 470, 472, 473, 480, 481
  - Fungal Tree of Life, 481
  - molecular, 466, 472, 473
  - multigene, 471
  - phylogenetic analyses, 360
  - phylogenetic classification, 360
  - phylogenetic investigation, 358
  - phylogenetic markers, 398
  - phylogenetic relationships, 396
  - phylogenetic studies, 358
  - protein, 462–466, 468, 481
  - rpb1, 462, 469
  - rpb2, 462
- Phytomyxa, 56, 57
- Phytophthora*, 4, 15, 25, 40, 44
  - P. cinnamomi*, 25
  - P. infestans*, 4
  - P. lateralis*, 15
- Pilaira*, 471–472
- Pink ear rot
  - F. proliferatum*, 111, 116, 117
  - F. subglutinans*, 111, 116, 117

- F. verticillioides*, 111, 116, 117  
infection, 111  
inoculum, 111
- Pityriasis capitis, 338
- Pityriasis versicolor, 338, 339
- Plant diseases, 59, 63
- Plant Pathogen Barcode, 146
- Plasmodiophora brassicae*, 52, 55–57,  
59–63, 70–72
- Plasmodiophorids, 51–73
- Plasmopara*  
*P. halstedii*, 37, 40–44  
*P. viticola*, 41, 43
- Podosphaera leucotricha*, 23
- Polygalacturonase, 474–475
- Polymerase chain reaction (PCR), 80, 82,  
83, 86, 136–143, 145, 147, 148, 150,  
258–259, 323–325, 327, 419, 421,  
427–431, 433, 477–480  
amplified fragment length polymorphism  
(AFLP), 479  
DNA sequencing, 266–267  
group specific, 98–100  
microsatellite PCR, 479  
multiplex, 317–328  
nested PCR, 262, 267  
PCR-RFLP, 477–479  
qPCR, 326, 327  
random amplified polymorphic DNA  
(RAPD), 259–261, 268  
random amplified satellites (RAMS), 263  
RAPD, 477, 479  
real-time, 324, 326, 477–479  
real-time PCR, 266  
restriction fragment length polymorphism  
(RFLP), 260–261  
sequence specific oligonucleotide probe  
(SSOP), 269  
species specific, 96–98  
taxon-specific PCR, 261–269  
terminal restriction fragment length  
polymorphism (T-RFLP), 261
- Polymerase chain reaction (PCR) assay,  
198–209
- Polymyxa*, 57, 58, 62  
*P. betae*, 57–59, 62, 63, 67  
*P. graminis*, 57–59, 62, 63, 69–71
- Polyphyly, 464
- Population structure, 137
- Post harvest diseases, 240
- Powdery mildew, 84–86, 89
- Powdery scab, 59, 61
- Primer, 303  
universal, 303, 307
- Proabsidia*, 441, 442
- Procalcitonin (PCT), 321
- Projects, genome, 465–466, 480–481
- Proteome, 70
- Protoabsidia*, 441, 442
- Pseudoabsidia*, 441, 442, 446
- Psoriasis, 338, 340
- Public databases, 214, 235
- Puccinia*  
*P. carthami*, 26  
*P. helianthi*, 10  
*P. irrequieta*, 9  
*P. jaceae* var. *diffusa*, 9  
*P. psidii*, 11, 18, 21  
*P. tanacetii*, 9
- Pucciniastrum corni*, 15
- Pythiales, 38, 39
- Q**  
qPCR, 161  
Quantitative real time PCR, 205
- R**
- Radiation  
basidiomycete radiation, 469  
pezizomycotina radiation, 469
- Random amplified polymorphic DNA  
(RAPD), 40, 133, 134, 136–137, 198,  
200, 202–204, 228, 279–281
- Real-time PCR, 139, 142–144, 148, 150,  
204–205, 207
- Real -time PCR technology  
SYBR Green, 188  
TaqMan, 188
- Red ear rot  
colonization, 112, 113  
DON, 112, 113  
*F. acuminatum*, 111  
*F. avenaceum*, 111  
*F. chlamydosporum*, 111  
*F. culmorum*, 111, 113, 116–119



- F. equiseti*, 111  
*F. graminearum*, 111–113, 117–119  
*F. heterosporum*, 111  
*F. poae*, 111  
*F. semitectum*, 111  
*F. sporotrichioides*, 121  
infection, 112  
inoculum, 112, 113  
symptoms, 109  
Reference material, 234  
Relationships, 467, 469, 470, 472, 473, 481  
Relevance  
  clinical, 461  
Resting spores, 55, 56, 60, 62, 67–69  
Restriction fragment length polymorphism (RFLP), 39, 133–136, 279–281, 287, 307  
*Rhizina undulata*, 25  
Rhizomorphs, 254  
Rhizomucor, 472–473, 475, 476, 478, 479  
*Rhizopus*, 213–243  
  *R. americanus*, 235  
  *R. arrhizus*, 216, 224, 226, 228, 230, 232, 235–238, 240, 241  
  *R. arrhizus* var. *arrhizus*, 221, 228, 236, 241  
  *R. arrhizus* var. *delemar*, 241  
  *R. caespitosus*, 227, 232, 238  
  *R. homothallicus*, 227, 232, 235, 238  
  *R. lyococcus*, 235, 236  
  *R. microsporus*, 216, 232, 235, 238  
  *R. microsporus* var. *chinensis*, 226  
  *R. microsporus* var. *microsporus*, 227, 235  
  *R. microsporus* var. *oligosporus*, 226  
  *R. microsporus* var. *rhizopodiformis*, 226  
  *R. schipperae*, 227, 238  
  *R. sexualis*, 227, 232, 235, 238  
  *R. stolonifer*, 224, 226, 228, 230, 232, 235–238  
  *R. stolonifer* var. *americanus*, 235, 237  
  *R. stolonifer* var. *lyococcus*, 235  
  *R. stolonifer* var. *sexualis*, 235  
  *R. stolonifer* var. *stolonifer*, 226, 235  
*Rhynchosporium secalis*, 13  
*Rhytisma americanum*, 22  
Ribosomal DNA (rDNA), 303, 307  
  cluster, 303, 307  
  intergenic spacer (IGS), 307  
  ITS, 469, 471–475, 478  
  large subunit (LSU), 303, 307  
  LSU, 469, 472, 473, 477–478  
  18S, 307, 308  
  28S, 307, 308  
  small subunit (SSU), 307  
  SSU, 468, 469, 472, 473, 477–478  
  variability, 307  
*Rosellinia necatrix*, 255
- S**  
Saprobe, 464, 473  
*Sclerotinia*  
  *S. sclerotiorum*, 81–84, 89  
  *S. trifoliorum*, 80–84, 89  
Seborrhoeic dermatitis, 338, 339  
Section *Discolor*  
  chemotypes, 116  
  *F. culmorum*, 115  
  *F. graminearum*, 115, 116  
  *F. pseudograminearum*, 116  
  morphology, 116  
Section *Liseola*  
  *F. anthophilum*, 114  
  *F. moniliforme*, 114  
  *F. proliferatum*, 114, 115  
  *F. subglutinans*, 114, 115  
  mating populations, 114, 115  
  phylogenetic analyses, 122  
*Seiridium*, 16  
Sepsis, 326, 327  
  causative pathogen, 317–319, 326  
  therapy, 319–322  
Sequence-based classification, 41  
Sequence characterized amplified region (SCAR), 138, 140  
Sequence tagged sites (STS), 138  
454 Sequencing, 147  
Sequencing, direct, 477, 480  
*Serpula lacrymans*, 13, 253  
*Siepmannia*  
  RFLP, restriction patterns, 447, 448  
  *S. lariceti*, 447, 448, 457  
  *S. parricida*, 447, 449  
  *S. pineti*, 447, 457  
  *S. zychae*, 447, 449

- Simple sequence repeats (SSRs), 137–138, 279–281
- Single nucleotide polymorphic sites (SNPs), 82
- Single-nucleotide polymorphisms (SNPs), 42, 139, 143, 147, 148
- Sirococcus clavignenti-juglandacearum*, 15
- SNPs. *See* Single nucleotide polymorphism
- Sodium dodecyl sulfate polyacrylamide gel electrophoresis (SDS-PAGE), 257
- Solexa, 147
- SOLiD, 147, 149
- Sorosphaera*, 53
  - S. veronicae*, 57, 61, 69
  - S. viticola*, 61, 69
- Species specific PCR
  - calmodulin, 115, 117
  - F. culmorum*, 116–118, 121, 122
  - F. graminearum*, 110, 116–119, 121
  - F. proliferatum*, 108, 111, 116–118
  - F. subglutinans*, 115–118
  - F. verticillioides*, 108, 116–120
  - IGS, 117–119
  - ITS, 117, 118
- Species-specific primers, 63, 163
- specimens, unknown, 214
- Sphaeropsis sapinea*, 13
- Spongospora subterranea*, 57, 59–62, 69
- 18S rDNA, 37, 38, 41
- 28S rDNA, 37, 41
- Stegophora ulmea*, 22
- Stem rot, 80–84
- Sterile mycelia, 284, 285
- Straminipila, 36
- Suspensor, appendages, 470
- Systematics
  - Index Fungorum, 481
  - Index Fungorum of CABI Bioscience, 471–472
  - molecular, 462, 473
  - Mycobank, 481
- T**
- Taphrina*, 14
- Taxonomic concept, 36
- Taxonomic position, 56
- Taxonomy, 358, 360, 392, 395, 396
- Technology, sequencing, 481
- Tens rule, 6, 22–24
- Tieghemella*, 441, 442
- Timber, 251–269
- Toxin-specific PCR
  - EF-1a, 119
  - F. culmorum*, 121
  - F. graminearum*, 121
  - F. sporotrichioides*, 110, 121
  - FUM cluster, 120
  - fumonisin, 108–109, 119–121
  - F. verticillioides*, 108, 119, 120
  - IGS-RFLP, 119
  - TRI cluster, 121
- Transcriptome analysis, 70
- Transformation, *Agrobacterium tumefaciens*-mediated, 481
- Translation elongation factor-1 $\alpha$  gene (TEF-1 $\alpha$ ), 137
- Transposons, 139–140
- Tree stability, 252–254, 263, 265
- Tri7*, 161–165, 169–170, 172, 173
- Tri13*, 161, 162, 164, 165, 169–170, 172, 173
- Trichoderma*, 185
- Trichomycetes
  - Asellariales, 464, 467, 468
- Trichophyton rubrum*, 13
- Trichosporon* spp.
  - laboratory diagnosis, 392–393
  - molecular detection, 393
- Trichothecenes
  - DON, 109, 110, 121
  - F. acuminatum*, 110
  - F. culmorum*, 110, 121
  - F. equiseti*, 110
  - F. graminearum*, 110, 121
  - F. sporotrichioides*, 110, 121
  - structure, 109, 110
  - T-2, 109, 110
  - toxic action, 110
- Tubulin, FtsZ, 464
- U**
- Universal primers, 462, 474
- Uredinales*, 11
- Uromyces heterogeneus*, 23

**V**

- Vegetative compatibility groups (VCGs), 132–134, 136
- Venturia*, 10, 14
  - V. inaequalis*, 13, 23
  - V. inopina*, 10
  - V. populina*, 10
- Verticillium*, 185
- Virus transmission, 59, 61–63, 67
- VYOO<sup>®</sup>, 325, 326

**W**

- White blister rusts, 37, 39, 44
- Wood rotting fungi, 251–269
  - brown rot, 251, 253, 254, 256
  - butt rot, 252, 254–256, 263
  - indoor wood decay fungi, 252–253, 257, 258
  - root rot, 254, 255, 263, 267
  - white rot, 251, 253, 254

**X**

- Xylanase-3* gene, 140

**Z**

- Zearalenone (ZEN), 160
- Zoopagomycotina
  - Dimargaritales, 464
  - Zoopagales, 464
- Zygomycetes, 215–217, 221–224, 231, 234, 241, 464, 468, 474, 478, 481
  - laboratory diagnosis, 394
  - molecular detection, 394–395
- Zygomycetous fungi, 461–481
- Zygomycosis
  - antimycotics, 472
  - entomophthoromycosis, 476
  - mucormycosis, 473, 481
- Zygomycota, 215, 221, 228, 230
  - Basidiobolales, 468
  - Entomophthoromycotina, 462, 467, 468
  - Kickxellomycotina, 462, 467, 468
  - Mortierellales, 469
  - Mortierellomycotinained, 469
  - Mucoromycotina, 462
  - Zoopagomycotina, 462, 467
- Zygosporium, 468, 470, 471